

NOVEMBER 17, 1958

ARS' John P. Stapp -  
Big Drive for '59

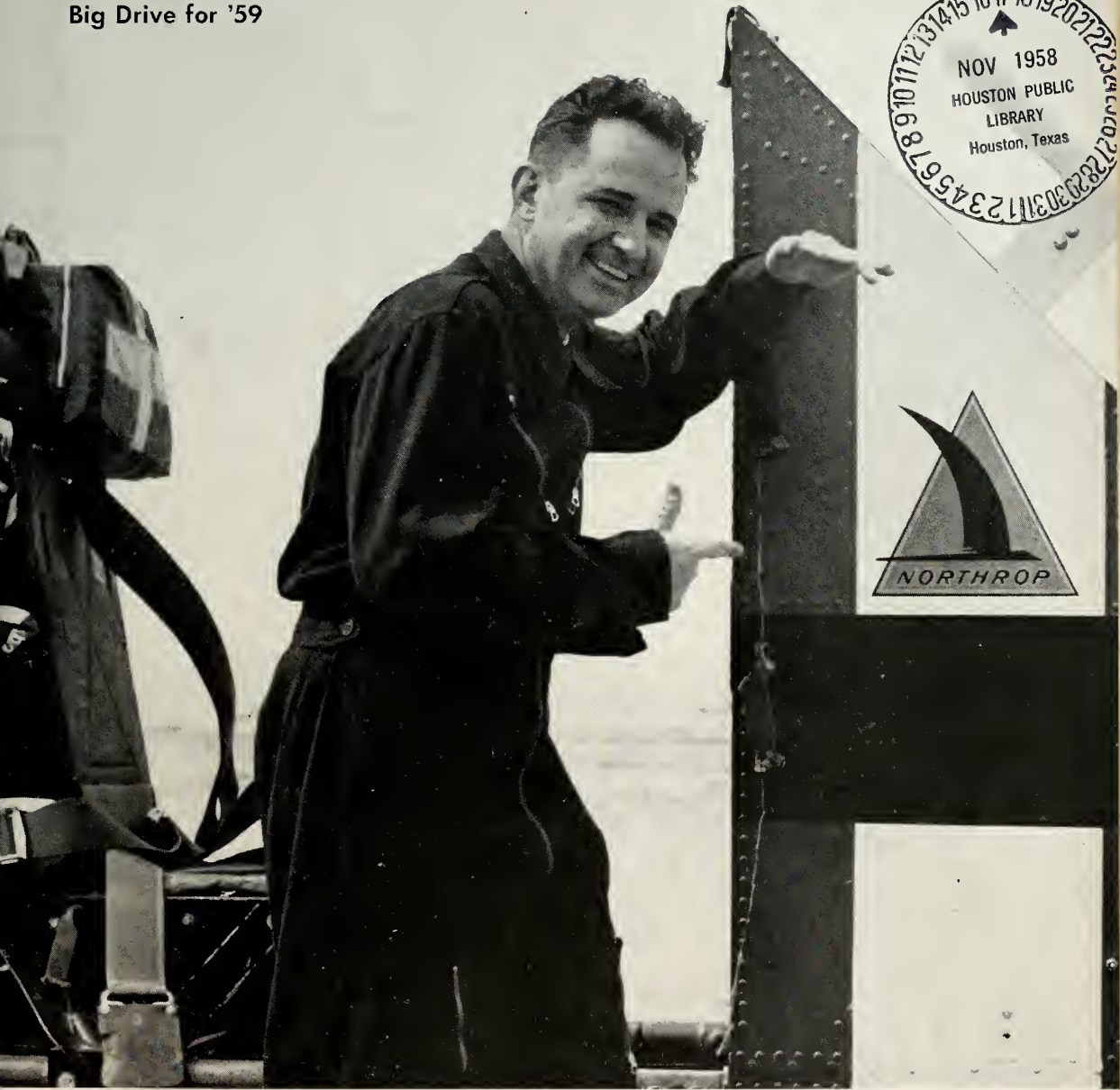

# missiles and rockets

MAGAZINE OF WORLD ASTRONAUTICS

Engineering and Electronics Edition

AN AMERICAN AVIATION PUBLICATION

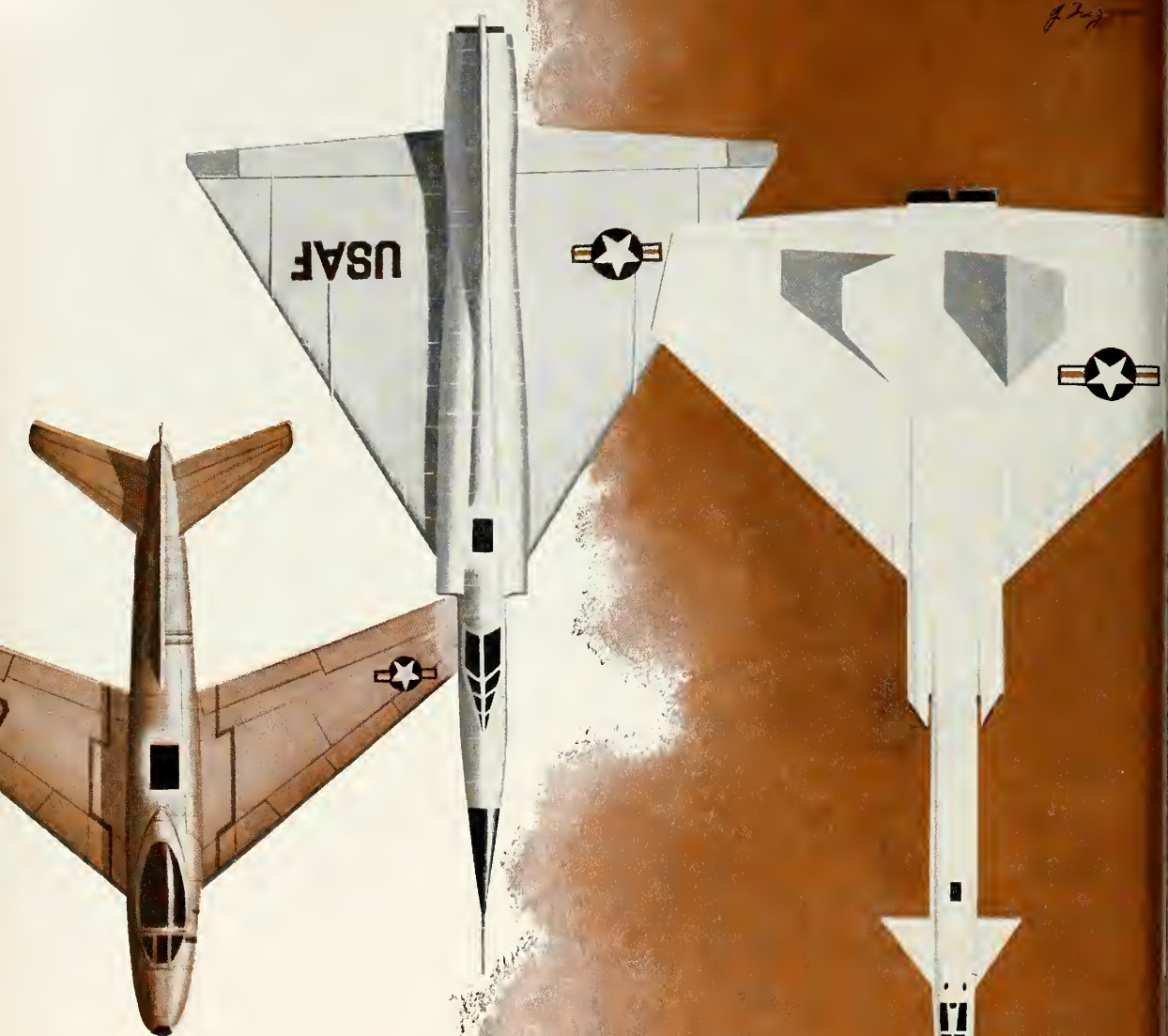

## SPACE-ABILITY

Servomechanisms' proven ability to design and produce consistently smaller and more reliable Central Data Computers, has established SMI as the pace-setter in this exacting science. This experience, coupled with our major scientific advances in new materials research and deposited film circuitry techniques, will meet the requirements of even smaller and more reliable subsystems for the spacecraft of tomorrow.



SUBSYSTEMS DIVISION, Hawthorne, California  
MECHATROL DIVISION, Westbury, L.I., New York  
SPECIAL PRODUCTS DIVISION, Hawthorne, California  
RESEARCH LABORATORY, Goleta, California  
GENERAL OFFICES • 12500 Aviation Boulevard, Hawthorne, California

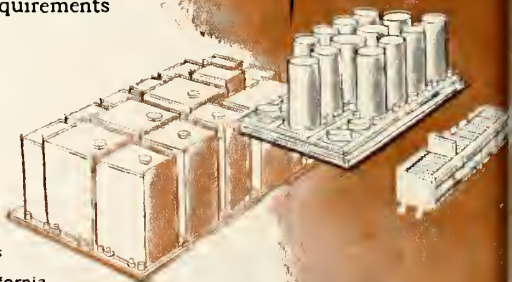



5,000 GALLONS OF FUEL—ROLLING IN UNIQUE TIRE-LIKE CONTAINERS CALLED ROLLI-TANKER—ARE CAPABLE OF FOLLOWING AMAZING “GO-ANYWHERE” TIRES INTO HERETOFORE **IMPASSABLE** AREAS!

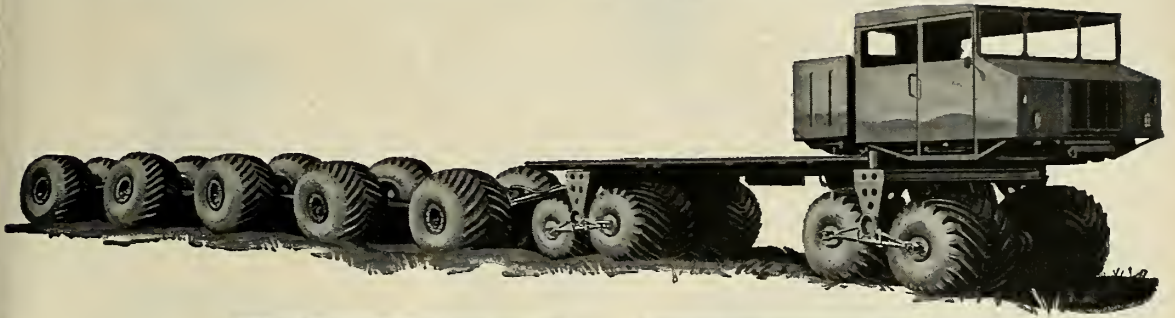

**ROLLI-TANKER**

**TERRA-TIRE**

LET YOUR PROJECT UTILIZE THIS AMAZING

# mobility

**Wide Ground Contact Area** of the axle-driven Terra-Tire by Goodyear can traverse sand, mud, marshland, snow and roughest going without failing. Principle lends “go-anywhere” mobility to vehicles—and liquids.



**Filled with fuel**, these Rolli-Tanker units—mounted in pairs and available in sizes with filled capacities of from 140 to 500 gallons each—can travel most anywhere! Tow-bar units can be equipped with own filling, emptying, braking systems.

**Float fuel ashore**—the Rolli-Tanker makes it no problem to get bulk fuel or liquid supplies ashore. No costly pumping or long-line hoses needed with this new Goodyear advance.



**Fuel ready, where needed**—this unique system is easily the most foolproof answer to needs for mobile fuel supplies. An advanced Goodyear development for national defense.

For details contact: Goodyear, Aviation Products Division, Dept. Akron 16, Ohio.



Terra-Tire, Rolli-Tanker-T.M.'s The Goodyear Tire & Rubber Company, Akron, Ohio



**Looking for a  
Fabricating Source...**

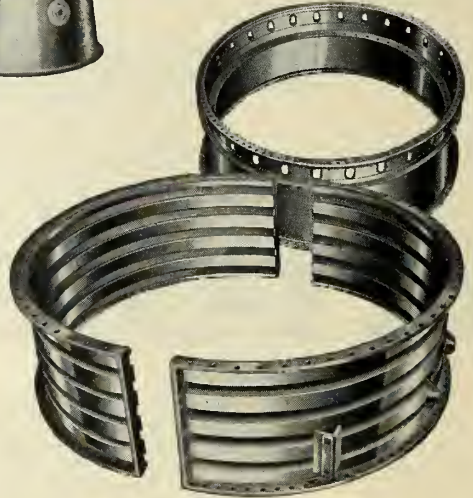
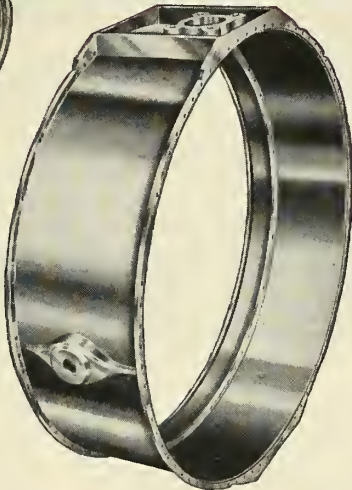

***of welded precision assemblies?***

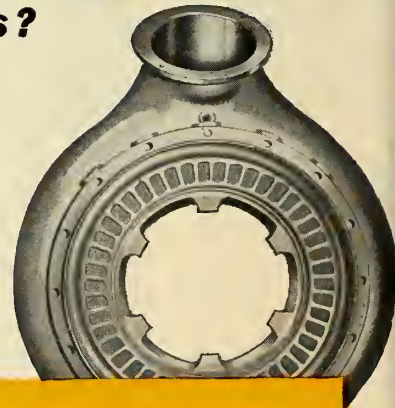
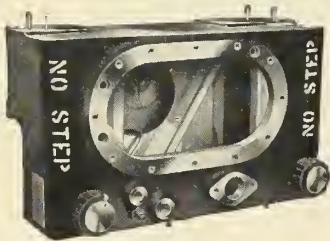

As a major producer of circular parts and welded components for the aircraft industry, Amweld<sup>®</sup> possesses special knowledge and techniques for forming, welding, and machining of assemblies. Fabricating of aluminum, titanium, stainless, and heat-resistant alloys is a major part of this work. Experienced metallurgical and engineering staffs, plus a skilled work force, make up this team of fabricating specialists which is available to you on a subcontracting or experimental work basis.

If you would like to obtain complete information on the capabilities of American Welding and how we can be of assistance to you—phone or write today. Our local representative will be happy to call and discuss your requirements.

**THE AMERICAN WELDING & MANUFACTURING CO.**  
554 Dietz Road • Warren, Ohio

**AMERICAN  
WELDING**

**Write for complete information.**  
NEW 20-page catalog of Amweld Rings, Bands,  
and Welded Assemblies.  
NEW booklet entitled, "HOW AMWELD FLASH  
BUTT-WELDED RINGS ARE PRODUCED."

Circle No. 4 on Subscriber Service Card.

missiles and rockets, November 17, 1958



**COVER:** *USAF Colonel John P. Stapp, pioneering human factors scientist, stands beside rocket sled. Colonel Stapp, vice-president of the American Rocket Society, is expected to be elected president at this week's ARS annual meeting in New York.*

*Editor* .....ERIK BERGAUST  
*Executive Editor* .....CLARKE NEWLON  
*News Editor* .....DONALD E. PERRY

**ASSOCIATE EDITORS:**

NORMAN L. BAKER ....*Engineering & Production*  
 RAYMOND M. NOLAN ....*Electronics & Guidance*  
 PEER FOSSEN .....*Optics & Telemetry*  
 WILLIAM O. MILLER .....*Military & Defense*  
 ALFRED J. ZAEHRINGER ....*Propulsion & Chemistry*

**ASSISTANT EDITORS:**

FRANK MCGUIRE ....*Legislative & International*  
 E. M. CROMLEY .....*Personnel & Management*  
 ELLEN BERLOW .....*Copy Editor*

**CONTRIBUTING EDITORS:**

FREDERICK C. DURANT III .....*Astronautics*  
 F. I. ORDWAY III, H. CANNEY and  
 R. C. WAKEFORD .....*Research*  
 DR. ALBERT PARRY .....*Soviet Affairs*  
 DR. HUBERTUS STRUGHOLD .....*Space Medicine*

**EDITORIAL ADVISORY BOARD:**

DR. WERNHER VON BRAUN ROBERT P. HAVILAND  
 DR. PETER CASTRUCCIO DR. ARTHUR KANTROWITZ  
 KRAFFT A. EHRLICHE DR. EUGEN SAENGER  
 RICHARD F. GOMPERTZ ALEXANDER SATIN

**REGIONAL EDITORS:**

F. S. HUNTER, RICHARD VAN OSTEN .....  
*Beverly Hills, Calif., 8929 Wilshire Blvd.*  
 ANTHONY VANDYK .....*Geneva, Switzerland*  
 10 Rue Grenus, Phone 321044

**PRODUCTION:**

WILLIAM H. MARTIN .....*Art Director*  
 COLLIS CAMPBELL .....*Asst. Art Director*  
 JOHN WALEN .....*Production Manager*  
 ELSIE GRAY .....*Asst. Production Manager*

WAYNE W. PARRISH  
*President & Publisher*

LEONARD A. EISERER .....*General Manager*  
 C. A. HURT .....*Assistant Publisher*  
 EDWARD D. MUELFELD .....*Advertising Sales Manager*  
 LAWRENCE BRETTNER .....*Circulation Director*  
 STEPHEN A. RYNAS .....*Advertising Promotion Mgr.*  
 DAGFIN T. FOSSEN .....*Research Manager*  
 GLADYS BUSSELL .....*Advertising Service Mgr.*

missiles and rockets Vol. 4, No. 20, Nov. 17, 1958

Published every week by American Aviation Publications, Inc., 1001 Vermont Ave., N.W., Washington 5, D.C. Printed at the Telegraph Press, Harrisburg, Pa. Second class postage paid at Harrisburg, Pa., and at additional mailing offices. Copyright 1958, American Aviation Publications, Inc.

Subscription rates: U.S., Canada and Postal Union Nations—1 year, \$8.00; 2 years, \$12.00; 3 years, \$14.00. Foreign—1 year, \$20.00; 2 years, \$30.00; 3 years, \$40.00. Single copy rate—\$.75. Subscriptions are solicited only from persons with identifiable commercial or professional interests in missiles and rockets. All subscription orders and changes of address should be referred to: FRANK R. WILLIAMS, circulation fulfillment manager.

# in this issue

## ▶ NOV. 17 HEADLINES

**Outlines of the U.S. Missile Industry**  
 Special m/r report gives statistical information on this major force in the nation's industrial machine ..... 11

**Field Open for Army Lunar Probes**  
 Two separate firing dates are open in December for four-stage vehicle relying heavily on *Sergeant* clusters ..... 14

**ARS Gears for Record Attendance**  
 Some 4,000 engineers and scientists expected for 1958 convention which will have 16 sessions, including three on space flight .... 16

**Commander George Hoover: 'Curious' Space Man**  
 Special m/r profile tells of his pioneering work in radically new integrated flight control system ..... 18

**New Army Missiles Revealed**  
 Information on *Missile Able, Mauler, Rattler* and *Redeye* ..... 46

**White Lance Details**  
 Chances are the improved *Bullpup* will have liquid engine, nuclear warhead ..... 48

## ▶ ASTRONAUTICS ENGINEERING

**Highway to the Stars is More than Dream**  
 Commander George Hoover discusses ONR's "Pathway" system ..... 19

**Air Transportable Missile Trailer Available** ..... 29

**Callery Ready for Boron Production** ..... 31

**Automatic Assembly Line Testing Cuts Falcon Costs** .... 34

## ▶ MISSILE ELECTRONICS

**Bureau of Standards: Calibration Is Its Task**  
 Electronic calibration facilities of new Colorado facility are important to industry.

## ▶ DEPARTMENTS

Washington Countdown ..	7	Keeping Track .....	43
Industry Countdown ....	9	New Missile Products ....	67
People .....	33	West Coast Industry ....	75
When and Where .....	36	World Astronautics .....	77
Space Age .....	40	Contract Awards .....	82
		Editorial .....	86





**Anti-Submarine Weapon System "RAT"**

The Navy RAT anti-submarine weapon system aims and launches missiles that seek out and destroy enemy submarines. Librascope designed the fire control system for RAT and assisted the navy in ship-board system integration. The RAT fire control receives information from target locators and automatically aims and sets RAT for a "kill". Its computers determine the ideal position for a missile to intercept the target. When the missile is launched, it travels through the air and enters the water where it attacks the target for "kill".

**RAT**...a new anti-submarine weapon...  
the fire control was designed and developed

by

**LIBRASCOPE**

The background of more than twenty years of design, development and manufacture of computers, controls and instrumentation are inherent values in all Librascope products. This experience and versatility in electronic, magnetic, mechanical and optical design concepts make for a new kind of reliability. Whether components or complete systems, Librascope can point to notable achievements. Let Librascope solve your computer problem. An inquiry on your letterhead will bring further information.



Librascope's use of the LGP-30 computer simplifies complex design and production problems, and assures computer-engineered quality in meeting design and delivery schedules.

**LIBRASCOPE**



A SUBSIDIARY OF GENERAL PRECISION EQUIPMENT CORPORATION

LIBRASCOPE INCORPORATED • 808 WESTERN AVENUE • GLENDALE, CALIFORNIA

6

Circle No. 5 on Subscriber Service Card.

missiles and rockets, November 17, 195



## washington countdown

### **ARPA is here to stay . . .**

and an increased budget to about a \$1 billion total will be asked for fiscal 1960. Total number of projects to be transferred to NASA is less than anticipated because of inherent military aspects which violate peace charter of the space administration. For first time, DOD is agreeing through ARPA to sponsor pure research, and is not requiring that a specific end product be identified with a weapons system.

### **Venus and Mars probes loom big . . .**

on the Washington scene. NASA scientists said the hardware already is on the shelf which would make the probes possible. Dr. Newell Sanders, assistant director for Advanced Technology, said present vehicles with boosters are capable of supplying the 25,000 mph required for Venus and the 25,900 mph needed for Mars. The probes may follow the three AF attempts and two Army tries to the moon's vicinity.

### **With the election unhappily . . .**

behind him, the President can turn his attention to the proposed transfer of the ABMA scientific team to NASA. Decision probably won't come until after next meeting of the Space Council, date unknown. Decision will involve ABMA and Jet Propulsion Laboratory and maybe more.

### **Space will take lots . . .**

of space on the upcoming Congressional agenda. Number one on a list of 12 national needs, in the opinion of Senate Democratic Leader Lyndon B. Johnson, is "to breathe life into the newly created space agency and to launch a program to explore outer space." Johnson said the nation is "heading into one of the greatest expansions of its history in a century of unparalleled opportunity.

### **Air Force revised security . . .**

restrictions covering missiles and subsystems in a recent directive. Engineering design and propulsion type information is declassified when they go into production for inventory or deployment to operational units. Details as to weight, length, performance data in general, external photos, and launch-information will be unclassified.

### **Electronics Warfare Simulator . . .**

was unveiled at the Naval War College, Newport, R.I. The block-long, three-story high, installation will carry out realistic combat command problems on a large scale. Thirteen years in the making, NEWS simulates employment of the latest missiles, and detection gear. Pentagon budgeteers say NEWS will provide advanced training heretofore limited by high cost of actual weapons and mock fleet operations.

### **Marriage of missile . . .**

*Eagle* and an aircraft is the Navy's answer to enemy forces attacking carrier task forces or amphibious landings. Vice Admiral Robert B. Pirie, Deputy Chief of Naval Operations (Air), said no new aircraft are sought for a "highly sophisticated" missile being developed for either air-to-air or air-to-ground use. Two aircraft are available—the Douglas A3D or the North American A3J. Both are capable of staying on station for four hours or more at the altitude required for such sentry duty.

### **Astronomical Budget is needed . . .**

if NASA is to take over many of the military space projects. One reliable source estimates the Air Force alone last year spent \$1 billion on space projects, in one way or another, from this budget or that.

There is no substitute for  
**EXPERIENCE**

when it comes to producing motors for  
 the aircraft and missile field



Type D-1066

For supersonic aircraft applications. .71 HP DC motor, 7600 rpm continuous duty, 24 volt. For pump drive. Weight: 6.5 lbs. Meets MIL-SPEC M-8609.

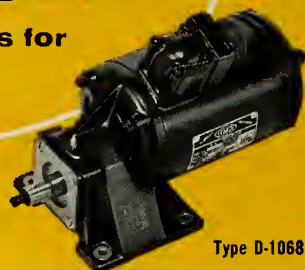

Type D-1068

For missile applications. 2.75 HP AC motor, 3140 rpm at gear box, continuous duty, 200 volt, 400 cycle, 3 phase. Power factor: 83%. Overall efficiency: 76%. Weight: 11.25 lbs. Meets MIL-SPEC M-7969A (ASG).



Type D-1086

For missile applications. 9 HP DC motor, 12,000 rpm intermittent duty, 56 volt, explosion proof. Weight: 14.75 lbs. Meets MIL-SPEC M-8609.

Here are eight special motors for eight different applications designed and produced by EEMCO for eight manufacturers of aircraft and missiles, and for related applications. Note the performance details for each: ratio of high output to size and weight.

EEMCO has designed and produced special motors for thousands of various applications in aircraft and missiles during the past 17 years. This is proof of EEMCO's unparalleled capabilities as a specialist in the production of high precision motors.

No matter what your problem may be in powering components for aircraft and missiles EEMCO has had experience that can help you. Your inquiry is invited.

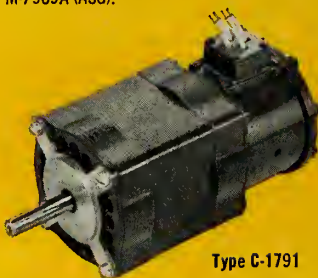

Type C-1791

For ultracentrifuge application. 1½ HP AC motor, 12,000 rpm continuous duty, 115 volt, 60 cycle, single phase, fan cooled. Weight: 12 lbs.



Type D-978

For missile applications. Tested successfully at over 200,000 ft. altitude, this ½ HP, 27 volt DC motor (ranges 24 to 32 volts) delivers 12,000 rpm, weighs 2.75 lbs, has radio noise filter, is explosion proof. Built for high shock and vibration loading. Meets MIL-SPEC M-8609.

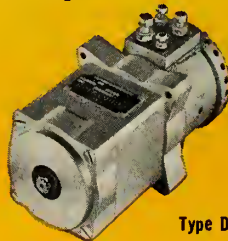

Type D-1025

For motor truck turbine engine applications. Starter-generator, weight 14.5 lbs. As starter: breakaway torque 220 in-lbs, terminal voltage of 20 volts. As generator: 40 amps continuously with intermittent peaks up to 80 amps at 28 volts.

Type D-632

For fan, blower, pump applications. Only 6½" x 2¼", weight 23½ ounces, delivers 50 watts continuous duty at 7500 rpm. Long life. Small motor wound for 28 volt DC, or 110 volt AC or DC. Meets MIL-SPEC M-8609.



Type C-1874

For actuator applications. 400 cycle, 3 phase AC motor and clutch. Intermittent duty, 12,000 rpm on 200 volts, 650 watts output. Weight: 4.5 lbs. Meets MIL-SPEC M-7969A (ASG).



**ELECTRICAL ENGINEERING & MANUFACTURING CORP.**

4612 West Jefferson Boulevard, Los Angeles 16, California—Telephone REpublic 3-0151

DESIGNERS AND PRODUCERS OF HIGH PRECISION MOTORS, ACTUATORS, AND RELATED EQUIPMENT... EXCLUSIVELY!

Circle No. 6 on Subscriber Service Card.



## industry countdown

### Full scale fluorine production . . .

at Metropolis, Ill., has been started by Allied Chemical's General Chemical Division. Liquid fluorine, the key to high energy chemical propellants will also play a major role in the new multi-million dollar uranium hexafluoride plant just opened at Metropolis for the production of UF<sub>6</sub> for the Atomic Energy program in 1959. Besides the use of fluorine for captive consumption in UF<sub>6</sub> production, there is sufficient capacity to also supply tonnage quantities for the country's rocket and missile program.

### Biggest merger story . . .

lately is Sylvania Electric Products into General Telephone Corp. Details of the proposed merger are being worked out now and will be submitted to stockholders of both companies soon. The plan will swing around a one-for-one stock exchange. D. C. Power, president of General Telephone will become chairman of the board, and D. G. Mitchell of Sylvania is slated to become president.

### Flight test simulators . . .

for investigating flight characteristics of unflown missiles have been sold to the Army Ordnance Missile Command and Convair-Fort Worth by Bendix Aviation Corp's Computer Division. Unit price—\$500,000.

### Low cost research for NASA . . .

in a major problem area will be conducted by the Ohio State University Rocket Research Lab. A one year research contract for \$28,889 calls for investigations into factors affecting the formation of detonation waves in rocket engines in an effort to determine why the engines destroy themselves. The Ohio State engineers hope to find ways of preventing detonations by learning how it is influenced by initial gas pressure and temperature, the type of gas mixture, fuel concentration and the diameter of the detonation chamber. About \$7,000 of the contract will be spent on a 12-foot stainless steel tube for carrying out the experiments.

### Mellon Institute . . .

in Pittsburgh has reportedly formulated several new alloys that show great promise for

solid fuel rocket motor casings. Several units fabricated to date when placed under test have shown reliable yield strengths over 225,000 psi. Mellon's R&D program is being backed by service funds.

### Openings for technical personnel . . .

may double in the next 10 years, according to a recent survey by the Scientific Apparatus Makers Association. Twenty-seven percent of 500 large firms polled replied that the demand for scientists, engineers and technicians in their organizations would be double by 1968. The rapidly expanding field of data computing and other electronic equipment is making a major demand for formally trained technical personnel.

### Navy problems . . .

for missile systems have really forced the issue of making missiles come of age. Contractors are now asked to provide repeated reliability for air-to-air and air-to-surface missiles under the same field conditions as artillery shells. This means two years storage in the open and six-foot drop tests as prerequisites for stock-pile weapon systems readiness. This will, without question, force stiff design requirements on the liquid storable systems planned for the *Bullpup* and *Corvus* air-to-surface missile systems. The liquid package people firmly state that this problem is within reason.

### Designers of Navy . . .

underwater missiles have still another problem. The velocity of the submarine and even surface-to-underwater missile structures must be able to withstand increasing dynamic pressures as a result of buildup in velocities. Specifications now call for resistances to ram water pressures of 10,000 psi.

### Heavy forging presses . . .

for missile builders received attention at a conference held at the Wyman-Gordon plant at North Grafton, Mass. last week. Objective was to determine the potentials of 35,000 to 50,000 ton presses required for nose cone ablation materials.



## BRUNSWICK TURNS OUT SHAPES WITH FANTASTIC FIDELITY

Brunswick has revolutionized the technology of fiberglass laminates with its exclusive new Strickland B Process (SBP). This unique method not only creates components with extremely high strength-to-weight ratios and heat resistance (up to 600°F.), but it also opens up a mass production system that meets fantastic new standards for precision.

SBP filament-wound laminates can be mass produced by fully automated machines. Whether one or one thousand . . . simple or compound configurations, including monocoque structures, SBP laminates meet the most rigorous space age specifications for precision and uniformity in skin thickness, size, dielectric constant and contours.

Brunswick research and development groups continually work to extend upper temperature limits and other unique features of SBL laminates. They also offer you skillful help solving problems in design development and fabrication. Write: The Brunswick-Balke-Collender Co., Defense Products Division, 1700 Messler St., Muskegon, Michigan

# BRUNSWICK

MAKES YOUR IDEAS WORK



## Here's the U.S. Missile Industry

Special m/r Report Gives Statistical Information on this Major Force in Nation's Industrial Machine

by E. E. Halmos, Jr.

The outlines of the industry that has grown up to support the U.S. missile effort are beginning to come into focus. And they show the emergence of a major force in the nation's industrial machine.

The vital statistics come out this way:

- There are 75 major prime contractors now at work.

- There are between 4,000 and 5,000 subcontractors with enough of their business volume in missile work to be identified clearly as part of the field.

- Together, these organizations are now doing an annual cash business—cash paid out for actual procurement items—of about \$3 billion. And they have a backlog of about \$3.5 billion of orders to work against.

- More than \$2 billion is being spent—in addition to that for procurable items—for research and development.

- In addition to the business done by organizations whose work can be directly connected to missiles, there are several thousand other business groups involved—and their share may aggregate \$1 billion or more. These include

suppliers of raw materials, and services such as construction work.

- More than 400,000 people are now directly employed (exclusive of the military) in missile work.

- Nearly every facet of U.S. industry; probably every major university, and a very great number of individuals representing every recognized profession including the law and medicine, is taking part.

These are the key conclusions of a survey of the spectacular growth of the field they serve by the editors of MISSILES AND ROCKETS.

- **Tough to check**—It is not surprising that no conclusive yardsticks have been developed to date. Probably no industrial field has grown up so quickly—even under the spur of wartime demand—as that of missiles.

And—like its end product—the industry has grown at a fantastic speed, and in fantastic directions. It has drawn on technologies that have existed almost since men began to use machines. But it has also created technologies for which there has never previously been any need.

In doing so, it has drawn into its orbit every kind of manufacturer from aircraft to razor blades, sewing ma-

chines and flour millers; every kind of technician from machinist to chemist; every kind of engineer from civil to electronic; physicists, physicians, psychologists, mathematicians, and many others.

Importantly, at first, very few of these men and organizations considered themselves to be in the missile business. Most of them considered that they were still watchmakers, or machine foundries, or chemical companies—supplying know-how or manufactured items to a new customer.

Among other things, missiles have also called forth a whole new aspect of doing business, where businessmen have been asked to bid on manufacturing a product that no one ever produced before, and for which plans exist only in the vaguest form—or not at all.

For these reasons, even the U.S. Census Bureau has been at a loss as to how to check facts. When the last business census was taken four years ago, missiles didn't count at all. But in the next census—to cover the year 1958 (but with questionnaires to be mailed out in 1959, and results to be available in 1960)—the bureau is still debating what questions should be asked,

(Continued on page 14)

### THIS IS THE MISSILE INDUSTRY:

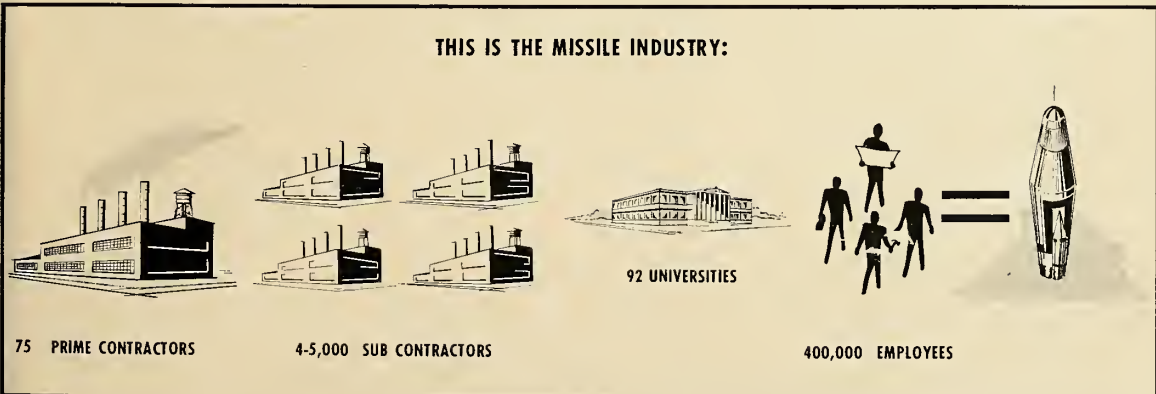

# Missile Prime Contractors

Listed here, together with the missiles for which they have primary responsibility are the United States' major prime contractors. Omitted from the listings are U.S. government agencies.

**Corporol**—Firestone Tire and Rubber Co. (missile and ground handling equipment); Gilfillan Brothers, Inc., Los Angeles (ground guidance equipment).

**Dort**—Curtiss-Wright Corp., Utica, Mich. (missile system) and Aerophysics Development Corp., Santa Barbara.

**Hawk**—Raytheon Manufacturing Co., Waltham, Mass. (system).

**Honest John**—Emerson Electric Mfg. Co., St. Louis (fins and warhead compartments); Douglas Aircraft Co., Santa Monica (fins and warhead); Hercules Powder Co., Radford, Va. (rocket motor M3); Thiokol Chemical Corp., Marshall, Texas (spin rocket motor M7).

**Jupiter**—Chrysler Corp., Detroit (missile fuselage and assembly, and ground equipment).

**Locrosse**—Cornell Aeronautical Laboratories, Buffalo; and the Martin Co., Orlando, Fla. (missile system).

**Nike**—Western Electric Co., New York (missile system).

**Pershing**—The Martin Co., Orlando (missile system).

**Plot**—Sylvania Electric Products, Inc., New York (missile system).

**Redstone**—Chrysler Corp., Detroit (missile system).

**Sergeant**—Jet Propulsion Laboratory, Pasadena (system); Sperry—Utah Engineering Lab., Salt Lake City (all critical R&D components), Thiokol (propulsion).

**Corvus**—Temco Aircraft Corp., Dallas Reaction-Thiokol (propulsion).

**Polaris**—Lockheed Missile Systems Division, Sunnyvale (system).  
Components:  
Aerojet General Corp., Sacramento (propulsion); Massachusetts Institute of Technology (guidance development); General Electric Co., Pittsfield, Mass. (guidance production and fire control); Interstate Electronics Corp., Anaheim, Calif. (instrumentation); Westinghouse Corp., Sunnyvale (launcher design).

**Rot**—Librascope Inc., Glendale, Calif. (fire control system); Cleveite Ordnance Inc., Cleveland (torpedo); Allegany Ballistics Laboratory, Cumberland, Md. (design of rocket).

**Regulus I and II**—Chance-Vought Aircraft, Inc., Dallas (system).

**Sidewinder**—Philco Corp., Philadelphia; General Electric Co., Utica, N.Y. (system).  
Components:  
Norris-Thermador, Los Angeles (pro-

pulsion, metal parts); Bridgeport Brass Co., Riverside, Calif. (propulsion metal parts); Eastman Kodak Co., Rochester, N.Y. (fuze); Minneapolis-Honeywell, Minneapolis (fuze); Elgin Watch Co., Elgin, Ill. (fuze); Baldwin Piano Co., Cincinnati, (fuze); Hubeny Bros., Roselle, N.J. (warhead, metal parts); General Time Corp., LaSalle, Ill. (safety and arming devices); Hamilton Watch Co. Lancaster, Pa. (safety and Arming devices); Lasko Metal Products, West Chester, Pa. (shipping containers).

**Sparrow III**—Raytheon Mfg. Co., Bedford, Mass. (system).

**Subroc**—Goodyear Aircraft Corp., Akron (system).

**Talos**—Bendix Aviation Corp., Mishawaka, Ind. (system).

Components:

Allegany Ballistics Laboratory (propulsion design development and pilot production); Sandia Corp., Albuquerque, N.M. (warhead); New Mexico State College, Socorro (warhead development); The Hicks Corp., Hyde Park, Mass. (booster metal parts); M. W. Kellogg Co., Jersey City, N.J. (booster metal parts); Sperry Gyroscope Division, Great Neck, N.Y. (radar set and computer); General Electric Co., Pittsfield, Mass. (launching systems); Bulova Research Lab., New York (safety and arming device); Melpar, Inc., Washington, D.C. (fuze); Northern Ordnance Inc., Minneapolis (power drives for launching system); Erco, division of ACF, Riverdale, Md. (warhead).

**Tormentor**—General Dynamics Corp., Pomona, and Applied Physics Laboratory, Silver Springs, Md. (design and development).

Components:

New Mexico Institute of Mines & Technology, Socorro (warhead development); Bendix Aviation Corp., North Hollywood (fuze research and development); Philco Corp. (fuze); Aerojet General Corp. (systems engineering); Vitro Laboratory, Silver Spring (systems engineering); Raytheon Mfg. Corp. Wayland, Mass. (guidance system); Sperry-Rand Corp., New York (computer); General Electric Co. (gun and missile director); Elgin National Watch Co., Burbank, Calif. (safety and arming devices); Northern Ordnance Inc. (power drives for launching system); Western Electric Co., Winston-Salem, N.C., (weapon direction).

**Terrier**—General Dynamics Corp., Pomona (system).

Components:

M. W. Kellogg Co. (booster & sustainers); Cameron Iron Works, Houston (booster and sustainer); The Hicks Co. (booster and sustainer); Northern Ordnance Inc. (booster

and sustainer); Philco Corp. (launcher) Elgin Natl. Watch Co., Burbank (safety and arming devices); Thompson Products, Cleveland (power drives); Vitro Laboratories (systems engineering); Sperry-Rand Corp., New York (computer); Midway Co., Lodi, N.J. (warhead metal parts); Firestone Tire & Rubber Co., Los Angeles (back fitting for launchers); Pacific Car & Foundry, Renon, Wash., (missile carriers); Universal Match Corp., Ferguson, Mo. (launcher); Sperry-Rand Corp., Sperry Gyroscope Div., Great Neck, N.Y. (radar set); Western Electric Co. (direction equipment).

**Atlas**—Ramo-Wooldrige Corp., Los Angeles (technical assistance); Convair, Los Angeles (frame); General Electric Co. (nose cone); North American Aviation, Los Angeles, (propulsion); General Electric Co. Burroughs Inc., Paoli, Pa. and Arma (guidance); American Machine & Foundry Co., Pacolma, Calif. (auxiliary power units).

**Bomarc**—Boeing Airplane Co., Seattle.

**Goose**—Fairchild Engine & Airplane Co., Hagerstown, Md., and Ramo-Wooldrige Corp.

**Falcon**—Hughes Aircraft Co., Culver City, Calif.

**Genie**—Douglas Aircraft Co., Santa Monica, Calif.

**Green Quail**—McDonnell Aircraft Corp., St. Louis and Boeing Airplane Co.

**Hound Dog**—North American Aviation, Inc., Downey, Calif.

**Mace**—The Martin Co., Baltimore and Goodyear Aircraft Co., Akron.

**Motodor**—The Martin Co.

**Minuteman**—Boeing Airplane Co., Seattle, AVCO Mfg. Co., Stratford, Conn.; North American Aviation, Inc.; Thiokol Chemical Corp., Ogden, Utah; Aerojet General Corp.

**Rosco**—Bell Aircraft Corp., Buffalo, N.Y.

**Snork**—Northrop Aircraft Inc., Hawthorne, Calif.

**Thor**—(Associate contractors) Thompson-Ramo-Wooldrige; Douglas Aircraft; General Electric; North American Aviation; A. C. Spark Plug Co., Milwaukee; Sandia Corp.

**Titon**—(Associate contractors) Thompson-Ramo-Wooldrige; the Martin Co.; AVCO; Bell Telephone Laboratories; Whippany, N.J.; American Bosch Arma, Garden City, N.Y.; Sperry Rand, St. Paul, Minn.; Aerojet-General; Sandia Corp.



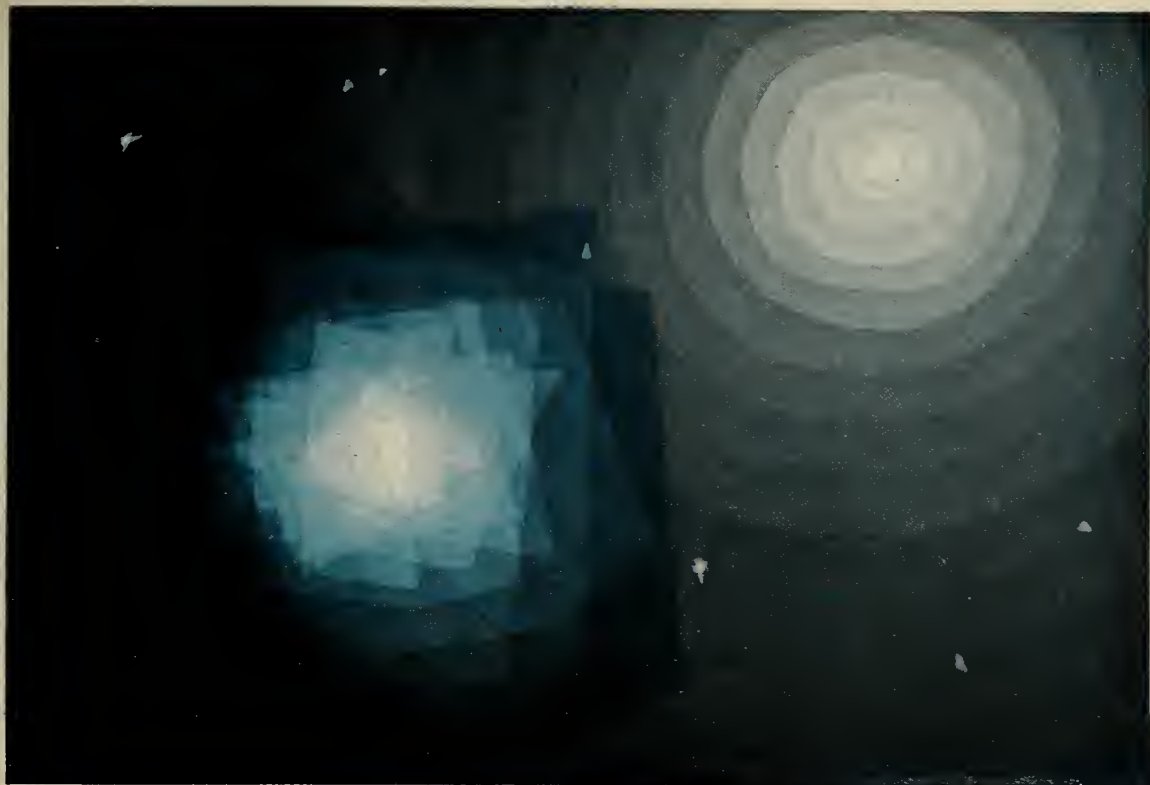

"EARTH IN SPACE," one of a series of paintings of the planets by Simpson-Middleman, painters who have been finding their subject matter in science. To quote them: "Earth is distinguished among the planets by its oceans of water and its single moon. From these as a starting point, earth in this painting has been imagined as a configuration of intersecting planes—layer on layer of blue—until it becomes a transparent crystal, glowing in space." Painting courtesy John Heller Gallery, Inc.

## Space power

The newest, most advanced Air Force missile project is Minuteman—a weapon system built around solid-propellant intercontinental ballistic missiles. Minuteman is under accelerated development for use by the Strategic Air Command, with the Air Force's Ballistic Missile Division managing the program.

Boeing is associate prime contractor for Minuteman assembly and test—an assignment that came to the company in recognition of its missile and system integration experience, its outstanding facilities and research capabilities. Boeing's organization, research and manpower resources have been geared to meet

the complex technological needs of the space age.

Engineers and scientists at Boeing are at work on other advanced research and development projects, including Dyna-Soar, a manned space vehicle that will orbit the earth at speeds approaching 18,000 miles an hour, and be capable of re-entering the atmosphere and making a normal landing.

Minuteman, Dyna-Soar and other advanced projects at Boeing offer exceptional space-age opportunities to engineers and scientists of all categories. Drop a note to Mr. Stanley M. Little, Department R-82 Boeing Airplane Company, Seattle 24, Washington.

**BOEING**

# Three Down, Two Probes to Go

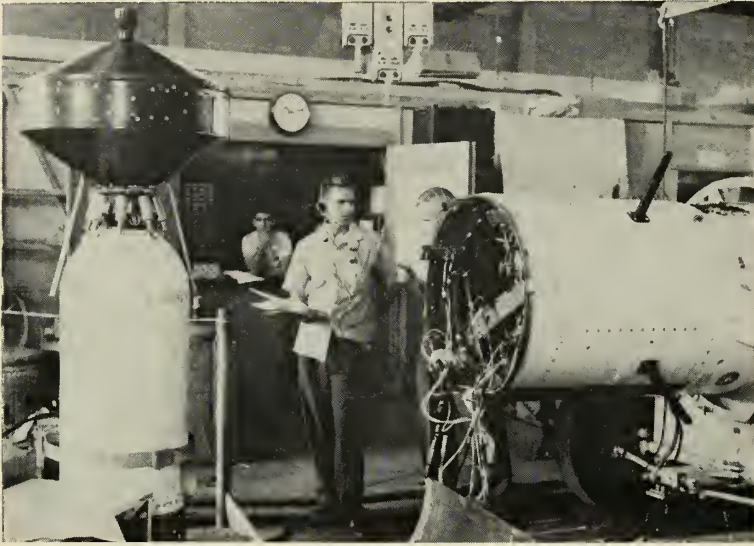

AIR FORCE moon probes had rigid checkout, but failed.

WASHINGTON—With three somewhat less than successful Air Force attempts to place a satellite in orbit around the moon to profit by, the Army is moving cautiously toward its own two scheduled lunar probes.

The first opportunity for the launching from Cape Canaveral will come early in December. Due to peculiarities in the moon's orbit, the possible dates are December 4, 5, 6 or 7 and then December 10, 11 or 12. The Army's probe, carried out under the direction of NASA, will not attempt to place a

payload in a lunar orbit, Army officials said. Army will simply try to shoot the fourth stage past the moon, coming as close as possible.

Under the original schedule the Air Force was given three attempts, the last in November, while the Army was given two tries, one in December and one in January. Presumably these might be delayed. As m/r went to press, Maj. Gen. John B. Medaris, chief of the Army's Ballistic Missile Command was moving slowly.

The first stage of the Army's ve-

hicle is to be an IRBM *Jupiter*. The last *Jupiter* firing from Canaveral was not successful.

There are one and perhaps two *Jupiters* scheduled for test firing from the Cape during November. If these should prove unsuccessful it is quite likely the space shot may be postponed. The Army does not want to waste its advanced stages on a faulty booster and, equally important, the Army does not want to fail.

• **Sergeant clusters**—According to the best information available, the Army vehicle will consist of the *Jupiter* booster, modified and elongated to provide more fuel, thus more thrust, a second stage of 11 clustered *Sergeant* rockets, a third stage of three *Sergeants* and a fourth stage of one *Sergeant*. The *Sergeant* is a highly-reliable, solid rocket. Since the Army is not trying for orbit, there will be no verniers and no retro-rocket.

The third Air Force try at 0230 hours on November 8, failed after a fine start. The *Thor* booster performed perfectly. The second stage (*Vanguard*) engaged and fired.

The third stage disengaged from the second and this fact, reported by the telemetry system, caused a premature report that the third stage had fired and all was well. It was not until 12 minutes later that doppler reports disclosing that the vehicle was losing velocity made it apparent that the third stage had not fired.

The probe reached a velocity of 16,000 miles an hour (24,000 plus is needed to reach the moon's area), and an altitude of only 1,000 miles.

## ... the missile industry (Continued from page 11)

and who should be asked, to show up the impact of missiles.

Numerous trade and professional groups—most notably the Aircraft Industries Association—have also attempted to take some measure of the field. Included in this list are such groups as the Electronics Industries Association, the U.S. Chamber of Commerce, a number of technical societies. Other government agencies, like the Small Business Administration, the Department of Defense and its branches, have also attempted to establish some boundaries.

• **How to do it**—Most of these attempts have been made from some special viewpoint, or for some special purpose. The overall picture, keyed in the opening paragraphs of this article, was developed after an intensive survey of available sources of information, comparison, and the addition of special

knowledge developed by the m/r staff itself.

For example, m/r's special market guide issue (April, 1958) listed 3,200 manufacturers involved in the missile field. The association of Missile and Rockets Industries has card indexes now listing more than 4,000 such firms. AIA has additional information, developed from inquiries to its own members, many of whom are prime contractors. (One missile alone—the Atlas—involved a prime contractor and six associates and no less than 1,209 subcontractors and suppliers). DOD, SBA and others have other lists.

A comparison of these statistics revealed some duplication, and some listing of firms that could not be definitely tied to the missile business—companies, for instance, producing a standard material which is used in missiles, but which also may be used in many other products.

Elimination of these factors produced the figure of between 4,000 and 5,000 subcontractors, who could definitely be tied into missiles.

As to employment totals (the 400,000 figure), all concerned agreed that a probably conservative estimate of employees of any subcontractor would be 50 persons—to account for very small operations, but allow for much larger ones (one California subcontractor, for instance, has more than 9,000 employees), and to allow a further factor for company employees who might not be chargeable to missile work alone.

Money figures are more easily obtainable. According to the Department of Defense, a total of \$2.7 billion was spent for "procurable missile items" during fiscal year 1958. As of August, 1958, \$442 million more was spent for such items. And as of the same date,

(Continued on page 53)



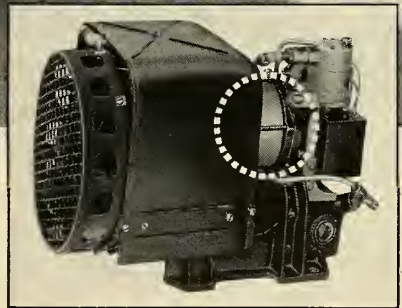
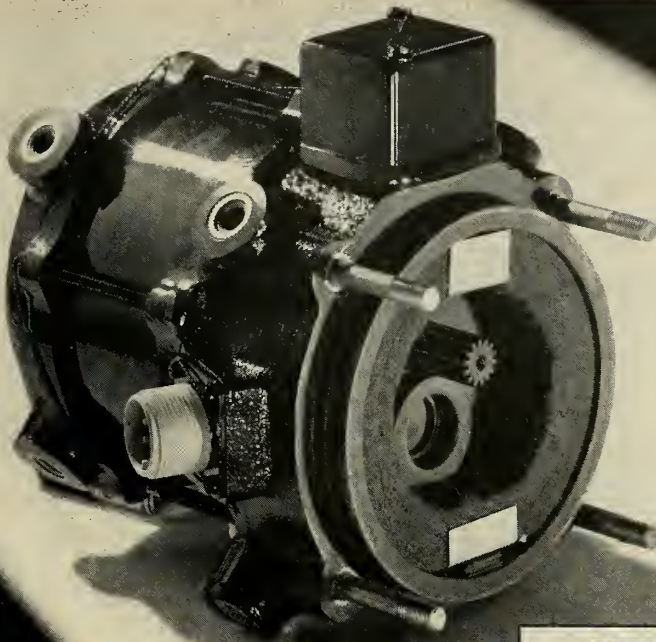

Model E6440-1 exemplifies Airborne capabilities in the design and development of large special motors. Inset shows application on Walter Kidde & Company lightweight compressor package (2.4 scfm, 3000 psi) used for auxiliary pneumatic power on jet tanker.

## AIRBORNE CAN HELP YOU WITH LARGE SPECIAL-DESIGN MOTORS

Photo courtesy Walter Kidde & Company, Inc.

Airborne can design and develop almost any type of large special motor you need and supply it in any quantity you require. Evidence of this capability is found not only in current projects, but also in the many different motors developed over the years for use on our own actuators and electromechanical systems.

Typical of the large special motors designed and produced by Airborne is the one above developed for Walter Kidde & Company to power one of its outstanding lightweight compressor pack-

ages. Special features include magnesium castings for weight savings; modified high-temperature insulation and lubricants; and a special thermal overload protector (Type C protection) to prevent winding damage at temperatures above 400°F.

Whatever your particular requirements in large special-design motors, it will pay you to consult Airborne. Chances are we can solve your problem in good time and at reasonable cost. Write, phone or wire for more information.

### GENERAL ENGINEERING DATA

Airborne Special Design Motor E6440-1

1. 115/200 v a-c, 400 cycle, 3 phase (conforming to MIL-M-7969A)
2. Rated 1.7 hp at 10,900 rpm—10 in-lb full load torque; 25 in-lb starting torque
3. Duty cycle: 30 min. on at full load/30 min. off
4. Ambient temperature: -65 to +165°F
5. Altitude: to 50,000 ft
6. Weight: 8.8 lb

LINEATOR® • ROTORAC® • TRIM TROL® • ROTORETTE® • ANGLgear®



**AIRBORNE ACCESSORIES CORPORATION**

HILLSIDE 5, NEW JERSEY



ROTOLOK

**NEW CATALOG SAM-58**

Describes Airborne special actuators and motors. Write for a copy today.

Represented in Canada by: WINNETT BOYD LIMITED • 745 Mt. Pleasant Rd., Toronto 12, Ont.

missiles and rockets, November 17, 1958

Circle No. 8 on Subscriber Service Card.

# ARS Gears for Record Attendance

Some 4,000 engineers and scientists expected for this year's broadened program of 16 sessions of which three will deal with space flight subjects

by Norman L. Baker

NEW YORK—The growth of the American Rocket Society at the end of the first year of the Space Age is dramatically represented by the size and scope and advanced attendance reservations for its annual meeting being held this week at the Hotel Statler.

For the first time in 12 years the ARS will hold its always eventful year-end meeting without the co-assistance and association of the American Society of Mechanical Engineers. The past relationship with the ASME had to be discontinued because of increased attendance resulting in a lack of hotel space.

For the ARS's first "go it alone" a record 4,000 engineers and scientists are expected to converge during the five days of this 13th annual meeting and astronomical exposition. Most of the 16 sessions on the agenda relate in some way to space flight. The broadening scope of the ARS program committee is illustrated by such session headings as "Sealed Cabins," "Psychophysiology," "Magnetohydrodynamics," and "Nuclear Propulsion." These three sessions, devoted entirely to space flight, is in contrast with the single Space Flight Symposium held at past annual meetings.

• **Many classified sessions**—The meeting is loaded with classified sessions—five in all, ranging from confidential to secret in nature. Although the ARS has held many classified sessions in the past, many of the members feel that such sessions are too restrictive to the general membership. This prevents many members from fully participating in the major function of the ARS—the dissemination of data and information vital to continued progress in the astronautics field. All of the classified sessions are being sponsored by the Army Ballistic Missile Agency.

AF Col. John P. Stapp, famed for his rocket sled experiments and this year's national vice-president, is expected to take over the fast growing society for 1959. The vice-presidency for the coming year is expected to go to H. S. Seifert, program chairman.

Hugh L. Dryden, deputy administrator for NASA, Roy W. Johnson, director of ARPA, and Simon Ramo, president of Space Technology Labs will be the guest speakers for Tuesday,



COL. JOHN P. STAPP expected to be 1959 ARS president.

Wednesday and Thursday, respectively.

The main event of the meeting, the Honors Night Dinner, has been moved from the final event of past meetings to a center position on Wednesday. In addition to the guest speaker (who has not been announced), other attractions will be presentation of awards to outstanding men in the field of missiles and astronautics. Most of the awards will go to men who have contributed to the advancement of space travel during the past year.

Richard Canright, ARPA, will receive the Robert H. Goddard Memorial Award; the James H. Wyld Award will go to Army Brig. Gen. Holger N. Toftoy; the G. Edward Pendray Award to Homer E. Newell of the Naval Research Lab.; the ARS Astronautics Award will go posthumously to the late AF Capt. Iven C. Kincheloe Jr., and the Hickman Award to Barnett Adelman of Ramo-Wooldridge.

• **Honorary memberships**—Fellow membership awards have been increased to twelve. Recipients of the honorary memberships will be Brig. Gen. Homer Boushey, USAF Director of Advanced Technology; C. T. Draper, MIT; Robert Gross, Fairchild Engine Division; Dan Kimball, Aerojet-General; Rear Admiral W. F. Raborn, Navy Bureau of Ordnance; Herbert Friedman, NRL; R. D. Gompertz, General Electric; Antoni K. Oppenheim, University of Calif.; Dr. Ernst Stuhlinger, ABMA; Abe Silverstein, NASA; James W. Wheeler, Sperry Gy-

roscope; and Louis Ridenour, Lockheed Missile Systems Division.

The Section Delegates Conference will be repeated for the second year due to the tremendous response at last year's conference. The conference affords ARS sections the opportunity to discuss administrative, financial, and policy problems encountered during the past year. Before the delegates conference was initiated the only time all the sections were represented at one meeting was at the section luncheons. The lack of time at these affairs prevented any actual "meeting of the minds." The Eastern Regional Student Conference, back for a repeat performance, has received an encouraging response with six papers to be presented. Both conferences will probably be listed hereafter as permanent affairs.

• **Many exhibitors**—Most of the major missile manufacturers will be exhibitors at the Second Annual ARS Astronautical Exposition. Representing the technical progress of astronautics, models of space ships, missiles, hardware components and equipment will occupy some 16,000 square feet in the Terrace Ballroom and the Penntop.

The past year has been the most prosperous of the American Rocket Society's history. Membership has jumped from more than 7,000 to approximately 12,000. Corporate memberships moved from 95 to 150, indicative of the increased industrial participation in the space age. Sections have increased from 34 to 41 and student chapters from 8 to 15. Total income for the ARS rose from \$453,000 to \$650,000.

• **Meeting program**—Partial listing of sessions follows:

Monday, Nov. 17  
Propellants  
Psychophysiology  
Combustion  
Nuclear Propulsion  
Tuesday, Nov. 18  
Sealed Cabins  
Magnetohydrodynamics  
*Thor-Able*  
Wednesday, Nov. 19  
Research Rocket Vehicles  
U.S. Space Capability  
Thursday, Nov. 20  
Large Liquid Rockets  
Large Solid Rockets  
Friday, Nov. 21  
Student Conference



# New! A Complete Catalog on All Types of Aeroquip Hose of TEFLON

AND REUSABLE "super gem" FITTINGS (PATENTED)



including:

## 666 HOSE

with single wire braid reinforcement for operating pressures up to 1500 psi.

## 667 HOSE

with double wire braid reinforcement for pressures to 2000 psi. in larger hose sizes.

## 677 HOSE

with spiral wrap wire reinforcement for operating pressures of 3000 psi.

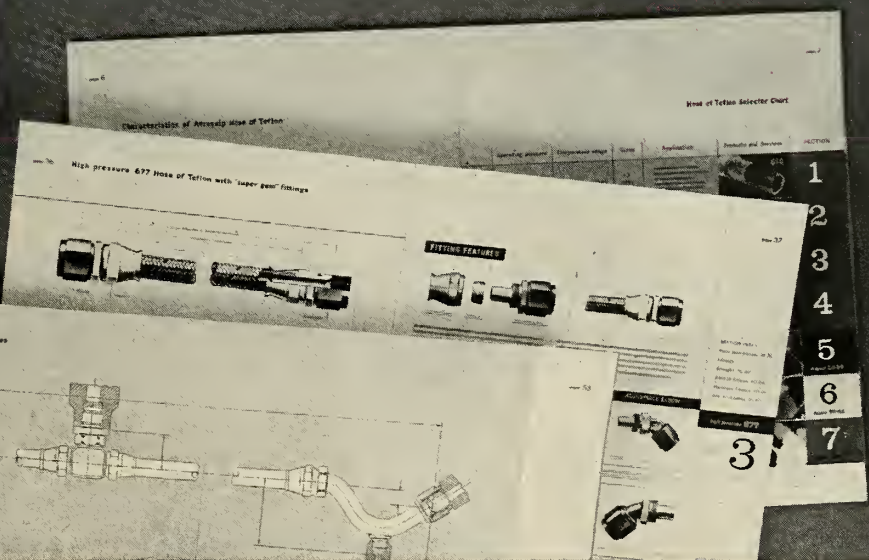

- 1
- 2
- 3
- 4
- 5
- 6
- 7

It's available NOW! It's free! This complete new 68-page catalog tells all about Aeroquip's extensive range of Hose Lines of TEFLON for air frame, engine and missile applications. Helpful information for design engineers includes technical and engineering data plus full specifications on all types of Aeroquip Hose of TEFLON, as well as both standard and special reusable "super gem" Fittings.

Send for your free copy of valuable, information-packed Catalog 103. Use the coupon below.



**AEROQUIP CORPORATION, JACKSON, MICHIGAN**  
**AEROQUIP CORPORATION, WESTERN DIVISION, BURBANK, CALIFORNIA**  
**AEROQUIP (CANADA) LTD., TORONTO 19, ONTARIO**

Teflon is DuPont's trade name for its tetrafluoroethylene resin  
 "super gem" is an Aeroquip trademark. U.S. Patent Nos. 2,833,567 and 2,731,279



Also Available—Aeroquip's New Precision Tube Forming Catalog.

If you would like to have this, free, when we send you Catalog 103, please check box.

Aeroquip Corporation, Jackson, Michigan MR-11  
 Please send me your new Catalog 103 on Aeroquip Hose Lines of TEFLON.

Name \_\_\_\_\_  
 Title \_\_\_\_\_  
 Company \_\_\_\_\_  
 Address \_\_\_\_\_  
 City \_\_\_\_\_ Zone \_\_\_\_\_ State \_\_\_\_\_



*m/r personal profile*

## Commander George Hoover: The 'Curious' Space Man

**His Work in Space Flight  
Resulted in Radically New  
Integrated Control System**

by Erica Cromley

One day in 1940 a young Naval flight instructor was testing a student in the flight simulator at Pearl Harbor Naval Air Station. As he watched him struggle over the trainer's dials, the instructor suddenly realized something was radically wrong with the method.

"Here's this man," the instructor mused, "knocking himself out trying to figure out where he is from the dials, while I know exactly where he is by watching this 'crab' move along a map."

It occurred to him that they were working things in reverse; that the man in the cockpit should have the instructor's aids.

It was then that George W. Hoover, age 25, started thinking seriously about a problem that was to occupy him for many years and which was to result in the radical new concept of the Integrated Control System, described in this issue.

Although Hoover later played a leading role in this country's early space efforts, he couldn't know then that his ideas would one day show promise of reducing the complexities of space flight to little more than driving an automobile.

• **A campaign begins**—Hoover knew that if he was going to sell his ideas and have the chance to develop them, Hawaii was not the place for an active campaign. He recalls:

"I discussed at some length with Admiral Ballinger, who was at that time in charge of the Pacific Fleet, some of the ideas I had about automatic navigation and new ways of displaying it. It was through a letter he wrote, plus the need for someone with instrument background, that I was brought back to the States.

"I was ordered to Special Devices, BuAer, where they gave me the job of head of the Flight Section which was attempting to build trainers for teaching instrument flying.

Hoover's group made studies on cockpit simplification, but in 1945 he realized that a complete overhaul of instrumentation called for much more knowledge than was then available. They hired a human factors engineer—Cliff Seitz—to find out how a man thinks and operates. Psychologists were hired and asked: "If you could do anything you wanted, disregarding the problem of building the equipment, what would the ideal cockpit look like?"

### **12 Firms Involved in 'Pathway' System**

*Principal contractors in ONR's Integrated Control System are:*

*Douglas Aircraft—coordinator of the fixed-wing program; Bell Helicopter—coordinator of the rotary wing program; Litton Industries—integrated control computer development; Kaiser Aircraft & Electronics—development of the thin TV windshield tube; Varo Manufacturing—micro-circuitry; Servomechanisms—basic materials research, sensor development; Minneapolis-Honeywell—free gyro for use as sensor; Bendix—high definition radar.*

*The four firms which made the original human engineering studies were General Electric, Dunlop and Associates, Deflores Engineering Co., and the Institute for Research in Human Relations.*

For a year, Cmdr. Hoover worked with Dr. Alex Williams of the University of Illinois studying such questions as: "How does man actually get the information he normally gets from the real world?"

"It turned out," Hoover said, "that we had to reproduce pretty much a facsimile of what the outside world looked like, although at that time we didn't have any idea of how we were going to implement this."

In his spare time he questioned every pilot he ran into to find out what information was needed in the cockpit. The surveys showed that the pilot requires answers to three questions: Where am I, and what am I doing? What should I do, and when? How am I doing?

• **Seven-cue world**—Meanwhile, the Navy contracted with three human factors engineering firms and General Electric to make a study of various phases of the problem. On the question of reproducing inside the cockpit what was going on outside, GE, Dunlop and Associates, Deflores Engineering Co., and the Institute for Research in Human Relations came up with basically the same answer: "Man's world is made up of 14 cues with seven predominating."

These seven resulted in the contact analogue and, Hoover says, "We felt we had solved the problem of orientation."

From the first time the contact analogue was used in a simulator, even those who had never flown knew which way was up and were able to operate the trainer.

"If the controls were coordinated,

*(Continued on page 79)*



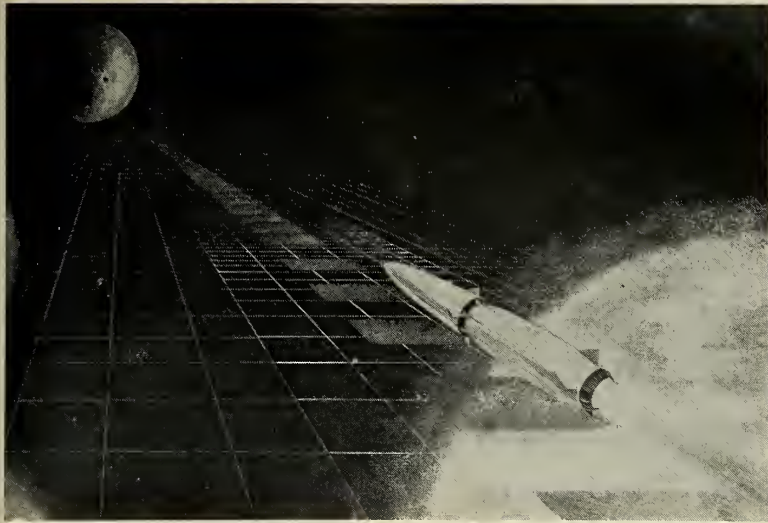

**ONR development will give pilot constant orientation in his space environment**

## Highway to the Stars is More than Dream

by Cmdr. George Hoover\*

In order to design a manned space vehicle we must first determine man's role in the overall man-machine complex. Is he to play an active or passive part in the operation?

Machines operate only because of specific man-made decisions. The most sophisticated automatic system requires man to impart intelligence to it, to start its operation, or to alter its program. Therefore, man's major role will be to make decisions, either in a passive or active capacity. Information must then be supplied to man in a form conducive to making decisions.

Decisions are made by exercising wisdom, and wisdom is knowledge of what is true or right coupled with just judgment as to action. Judgment is a critical evaluation of the facts at hand. It becomes apparent that correct or good decisions can be made only if all of the facts are at hand—and in a form acceptable to all of the human sensory systems.

• **Decision by Vision**—The visual sense is the most powerful because man has evolved in a visual world. Although it is essential that any visual input to man must be compatible with his other sensory systems, this discussion will be confined primarily to information displayed in visual form.

Since the manned space ship is a man-machine system, its effective per-

formance is a product of both. If either is deficient, the performance of the system will be deficient. It is imperative, then, that reliability of the equipment and the design of the information display and controls be given prime consideration.

To determine any adequate display system it is necessary to first define the

operations to be performed by the operator. In the space ship, the overall objective is essentially the same as for any transportation system—merely to go from point A to point B.

The total operation can be divided into several sub-goals such as launching or take-off, transition to orbit, orbit, departure from orbit, return to orbit, re-entry, and landing.

• **Flight modes**—The classical approach to space flight has been to assume that orbiting technique will be required with each flight, starting and ending with an orbit about the earth or other body in space. It is equally important to consider the possibility of direct flight without orbiting when the necessary means of propulsion is found. In this instance, the modes of flight would be much like those of ordinary aircraft.

Looking at each of the flight modes, the following is submitted as a partial list of information requirements. In addition to being divided into sub-goals, the information required is listed under three main categories of orientation, director, and quantitative. Man must know "what he is doing," "what he should be doing," and "how he is doing."

A comprehensive study of the total information requirements must be conducted to insure that the requirements are complete for every phase of flight

(Continued on page 21)

### The 'Why' of This Story

*For years many dedicated men have dreamed of sending man into the limitlessness of space. That dream is rapidly approaching the realm of reality.*

*First the power had to be developed. This has been achieved through the need of defensive military weapons—the banker for the space travel planners.*

*Next came the need for educating the populace to the value of placing man himself beyond the earth. This is being supplied because of prestige loss and anticipated military requirements.*

*In the meantime, planners such as Commander George Hoover have been busy preparing for the day when manned space flight will arrive. This article should help to convince the uninformed that man and the machine should be ready at the same time.*

\* Manager, Weapons Systems, ONR.



**Bounce one off the moon**

It wasn't very long ago when space engineers weren't equipped to bounce a missile off the face of the moon. Today they're thinking far beyond this near frontier of outer space. Just as Ex-Cell-O rocket and missile components help put missilemen within shooting distance of the moon, so will Ex-Cell-O products play a pioneering role in conquering other outposts of the universe. Ex-Cell-O also supplies fuel nozzles, blades, rotors, valves, actuators, fuel controls, parts and assemblies for jet aircraft and missiles.

**EX-CELL-O**  
CORPORATION  
DETROIT 32, MICHIGAN

*Aircraft Division*

MAN AND MISSILES FLY HIGHER, FASTER AND SAFER  
WITH PARTS AND ASSEMBLIES BY EX-CELL-O



EX-CELL-O FOR PRECISION



# ... highway to stars

and the fundamental requirements necessary to all space ship operators.

• **Operator interrogation**—Uncovering these fundamental requirements will require an unusual method of interrogation. Since there are no experienced "space pilots," we must draw from experienced aircraft pilots and submarine commanders the information necessary to perform space flight tasks.

For conditions which are not similar, we must extrapolate in terms of known operations. "Why" must be asked until the "why" questions the validity of the objective, or until the answer can stand unchallenged. This process, a tedious task, must be carefully carried out if the precise information is to be obtained.

As an example: A pilot will be asked what he would need to know for re-entry. His answer would probably be that he requires attitude information. When asked "why," he will probably say that he wants to know his attitude in order not to exceed limiting skin temperatures. Again when asked "why," he will probably state that if the skin temperature rises too high he will burn up.

Obviously this is his real concern and the attitude relative to the horizon will not solve his problem. In the first place, we would have to establish the attitude frame of reference. This would be the attitude relative to air density in order to maintain temperatures which can be dissipated. Attitude based on any vertical reference would not meet the requirement.

The inputs would be air density, rate of change of air density, actual temperature and rate of heat dissipation capability. In other words, attitude in this instance is relative to a variable path of feasible re-entry.

This is not the complete answer, but should serve as an example of the type of analysis that must be made to establish the fundamental information required.

• **Display requirements**—Once the information requirements have been established, the next step is to establish display requirements. Since man was born as an earth creature into a visual world, it is essential that his display conform to the patterns by which he originally learned to orient himself.

This would minimize any reconditioning of his reflexes when operating with the displays. Man's world consists primarily of a flat plane to which he orients himself by a set of visual cues.

One important visual cue is an **internal reference**, permitting the pilot to regard himself and his craft as a single unit. This reference normally is available to aircraft pilots in the form of a windshield. (In space, because of damage from meteoric particles, it may be necessary to utilize an electronic device for reproducing the actual outside view, with a viewing screen used in the same location as that of a windshield.)

A second important visual cue is an **external reference**. The most common external reference is the horizon, which

enables the pilot to determine the relationship of his aircraft to external objects or plane of reference.

This external reference will change depending on the particular plane of reference being used. It may be the earth's horizon, the plane of an orbit, or the plane of trajectory. It may also be the plane relative to a set of conditions such as described for re-entry.

In any event however, it must always appear to the pilot as his horizon, the reference with which he learned to orient himself. This information alone, often gives rise to misinterpretations. Parallel lines, apparently converging, represent **linear perspective**, helping the pilot to judge angular and altitude

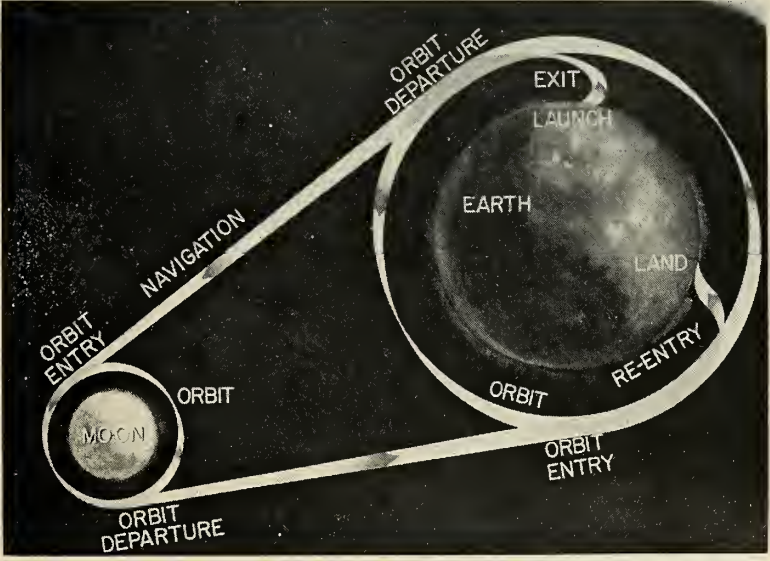

THE TOTAL MAN operations divided into launching, transition to orbit, orbit, departure from orbit, return to orbit, re-entry and landing.

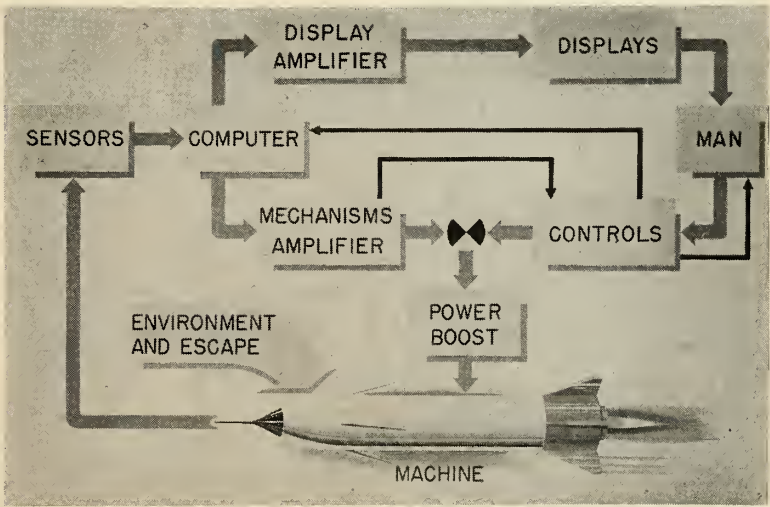

MAN-MACHINE SYSTEM—Essentially the same as for aircraft, the system becomes a marriage of the aircraft and submarine man-machine systems.

## MISSILE ENGINEERING

The "collapsing of time" concept has taken on added significance as a result of the current international situation. In Tucson, Arizona, Hughes has established the Tucson Engineering Laboratory for the purpose of shortening the elapsed time between missile development and its effective tactical use. This activity, established over 2 years ago, has proven that the quasi-simultaneous development and production of missiles can become a feasible reality.

The Tucson Engineering Laboratory is now expanding its scope of operations. Mechanical Engineers, Electrical Engineers, or Physicists who like to work on urgent problems and who have the ability and enthusiasm to constantly improve the product and its reliability, will find this an ideal environment. Specific areas of interest include: missile system analysis, infrared and radar guidance systems, electromechanical and hydraulic control systems, missile and test equipment and electronic circuit design.

An added advantage: Tucson's dry healthful climate. Investigate by sending resume to Mr. W. A. Barnes at:

*the West's leader in advanced electronics*

# HUGHES

TUCSON ENGINEERING  
LABORATORIES

Hughes Aircraft Company

Tucson, Arizona

## ... highway to stars

changes. The texture of a reference surface is used by the pilot to determine slant of the surface, altitude, and distance.

This powerful visual cue is sufficient in itself to establish orientation without reference to the horizon. A textured surface representing the sky, composed of a distinctly different pattern from the ground pattern, provides orientation when the ground plane is not available.

Movement over the surface results in an apparent distortion of the visual field, and this is known as **motion parallax**. Motion parallax provides a compelling cue to distance, speed, and direction of motion.

• **Contact analogue**—By integrating the visual cues abstracted from the real world, an artificial model can be created which for purposes of orientation is perceptibly equivalent to the real world. A display created from this model may be called a Contact Analogue.

Flying visually in space will be like flying on a black moonless night over uninhabited land or water. There will be no basis for orientation, no horizon, no ground reference, and no sky reference except a mass of stars in all directions.

Man will be subjected to a completely new environment, not only in

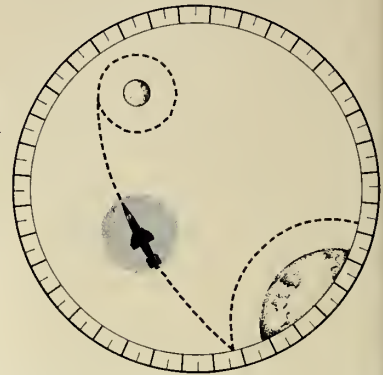

**SITUATION DISPLAY**—Such a display would show the earth, the destination, orbits, flight trajectory, etc., and the ship's position relative to flight plan.

its physical makeup, but new in the sense of having none of the basic cues and references by which man has learned to orient himself. Without an adequate set of references such as the Contact Analogue, he will be subjected to an awesome nightmare of helpless dis-orientation in an endless void.

Just as important is the need for recreating the basic cues of the visual earth world. In other words, the pilot must know "which way is up." Man must take along a little more of his environment in the form of a simu-

### Flight Mode Requirements

Flight Mode	Orientation	Director	Quantitative
Launch	Spatial Orientation	Direction of trajectory	Accuracy of position on trajectory Proper power Condition of ship and power plant
Transition to orbit	Spatial Orientation Situation display	Direction of trajectory Direction of thrust	Accuracy of position on trajectory Proper power Time of entry in orbit Condition of ship and power plant
Orbit	Spatial Orientation Position in orbit (Situation Display)	Direction of orbit Direction of thrust	Position on trajectory Position in orbit Proper power Condition of ship and power plant
Departure from orbit	Spatial Orientation Position in new trajectory	Direction of trajectory Direction of thrust	Proper power Fuel remaining (relative requirement for total trip) Position in trajectory



lated surface plane to supply the necessary inputs to his visual sense and add to his emotional stability. This plane would be the Contact Analogue.

In space flight, the line connecting these two points must lie in the simulated plane. Obviously, the paths of flight will be curved as will the planes, but since the distances are great, the plane will appear to be flat. The equations for establishing this theoretical plane will be established by the phase of flight being conducted at the time.

With such a display, man's basic orientation requirements will be met and space will become an extension of his natural habitat.

• **Simulated highway**—In space, even with the simulated plane, the real world does not contain any natural paths for man to follow. It is necessary then, to provide a theoretical path or means of providing direction information.

Studies for aircraft have indicated that the basic orientation cues are the elements with which a "highway" can be constructed to which man will react just as he does when driving a car down an ordinary road. It is this "highway" which will provide the necessary information to keep the pilot oriented and tell him what he should do in order to maintain his planned program.

Fed by the output of a computer solving the flight equations, the highway will show the operator whether he is high or low and right or left of the precomputed flight path.

In addition to the deviations, a set of markers along the highway moving at a predetermined velocity give the pilot his motion relative to the proper velocity along the trajectory. If the markers are moving with the craft, the correct velocity is being maintained.

If the markers are faster or slower than the craft, the velocity is too great or too little. Such a display gives the controller the same kind of information which he gets when passing other vehicles on a road.

The highway can provide more than just navigation information. As the computer solves the vehicle position within its operating envelope, the highway can be displaced in order that the operator can follow it to provide not only a safe margin within the envelope, but maximum utilization of his power at all times.

The highway can also show corrections to be made to maintain the proper trajectory. As an emergency device, the highway can be programmed by the computer to give the pilot a path to alter his flight plan, for instance, in order to return to earth as quickly and safely as possible.

Awareness of where the craft is



## high-temperature components



Kearfott components for missile and aircraft systems can provide optimum performance at temperatures as high as 200°C. Moreover, this peak performance is unaffected by 2000-cps vibration and 50-G shock. Kearfott's compact, light-weight and corrosion-resistant components provide this consistent record of accuracy:

**Synchros:** Sizes 8 through 25. Errors as low as 20 seconds from E. Z.

**Motor-generators:** Sizes 8 through 18. Linearity of 0.01%.

**Servomotors:** Sizes 8 through 25. Wound for transistorized amplifiers.

Kearfott research is continually developing even more accurate and more durable components . . . preparing for the needs of tomorrow. For details, write today or contact your nearest Kearfott sales office.

**Engineers:** *Kearfott offers challenging opportunities in advanced component and system development.*

# Kearfott



**KEARFOTT COMPANY, INC., LITTLE FALLS, N. J.**

A Subsidiary of General Precision Equipment Corporation

Sales and Engineering Offices 1378 Main Ave., Clifton, N. J.

Midwest Office 23 W. Calendar Ave. La Grange III South Central Office 6211 Denton Drive, Dallas, Texas

West Coast Office 253 N. Vinedo Avenue, Pasadena, Calif.

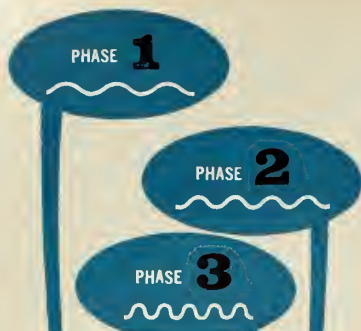

for *HIGHER* frequencies,  
particularly 3-PHASE power!

## INVERTRON® AC Power Source



MODEL 253-D-3

**COMPLETE ELECTRONIC**  
Stable AC Power . . .  
by **BEHLMAN**

Leading aircraft and missile builders use INVERTRON for accurate tests of subsonic to supersonic frequencies, at power outputs from milliwatts to kilowatts. It's silent and dependable!

- 3-Phase—250 VA to 3000 VA
- Two-Phase—80 VA to 1000 VA
- Single-Phase—160 VA to 2000 VA
- Output Frequencies—50 CPS to 3000 CPS
- Fixed or Variable Output, according to model
- Frequency Accuracy—0.5% to 0.001%
- Special Specifications to order

WRITE for Literature on Custom  
Instrumentation at Production Line Prices



2911 WINONA AVENUE  
BURBANK, CALIFORNIA Victoria 9-4475



## . . . highway to stars

relative to the plane helps to establish emotional stability, or "pilot tranquility." The highway, however, being in close proximity, gives the necessary cues for accurate changes in altitude, attitude and direction. Its rate of motion will be within the range of the pilot's capability to perceive changes and respond within his reaction time.

In other words, although the craft may be going thousands of miles per hour, the display will be such that the craft will appear to be moving over the highway at perhaps only 50 miles per hour.

• **Situation display**—In addition to the basic orientation and director display, the pilot must be provided with a separate indicator for situation display. This device will give the operator navigation information, cruise data, and information for flight planning.

Information concerning position of orbit with respect to earth and the objective in space, present position and heading, objectives or destinations, flight plan and fuel range remaining, could be integrated into such a display.

Information on the situation display would be long-term data giving the pilot his position relative to the total flight. Such a display would show the earth, the objective of destination, the orbit or orbits around each objective, the programmed flight trajectory, departure and re-entry paths, and the ship's position relative to the pre-planned flight plan.

Quantitative information would be separate from the orientation and director displays. These displays would give such information as power, position in elevation relative to orbit or trajectory, ship condition, radiation level, temperature, pressure, and meteoric dust concentration.

These displays would give the desired or allowable limits as well as the actual condition, and in a way which would permit the operator to take positive action if required.

To achieve such a set of displays it will be necessary to conduct studies to determine the technical requirements for the system necessary to create the displays. Unnecessary redundancy and duplication in a space ship cannot be tolerated. Where alternate or standby elements are needed, additional units can be accepted, but reliability must be the paramount consideration in every part of the total system.

The effectiveness of the manned space ship will be a product of the man and machine. The man-machine system will be essentially the same as

## STEEL FABRICATING COMPANY

AVAILABLE NOW  
FOR

LEASE, MERGER, OR SALE

This prominent Southern California Company has had an excellent reputation as a leader in its field (for more than 50 years) as a quality manufacturer of many types of products and equipment for industry, contractors, and defense.

If your product is made of steel, aluminum, or other metals, do not fail to examine this unusual opportunity to acquire a first class company or plant facility.

Can lease facilities only; exchange stock; merge; sell assets; or manufacture products to your specifications.

Write: Mr. Robert W. Eberle  
712 South Spring St.,  
Los Angeles, California

## INFRA-RED DOMES of Bonded Sections

(IRDOMES)

• ANY DIMENSIONAL ACCURACY  
REQUIRED

• UNLIMITED SIZES

• VARIETY OF SHAPES

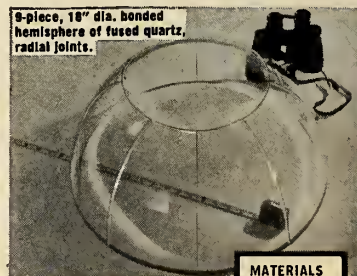

### MATERIALS

Quartz  
Silicon  
Calcium  
Aluminate  
Sapphire  
Arsenic  
Trisulphide  
Germanium  
Magnesium  
Oxide  
Glass  
Strontium  
Titanate  
Metals

Bonded section iridomes can be furnished in spheres, hemispheres, aspherics, flats, polyhedrals made of flat plates, and combinations of these shapes. Several different bonding agents are available, depending on the use and environment. The bonding agents will withstand the environmental stresses as well as will the parent material. Bonds are available that will withstand temperatures as low as  $-238^{\circ}\text{C}$ . or up to  $1200^{\circ}\text{C}$ .

**PRECISION LAPPING Company, Inc.**  
34 Clinton Ave., Valley Stream, L. I., N. Y. • LOcust 1-2770

Circle No. 29 on Subscriber Service Card.



## Radar Research at Westinghouse

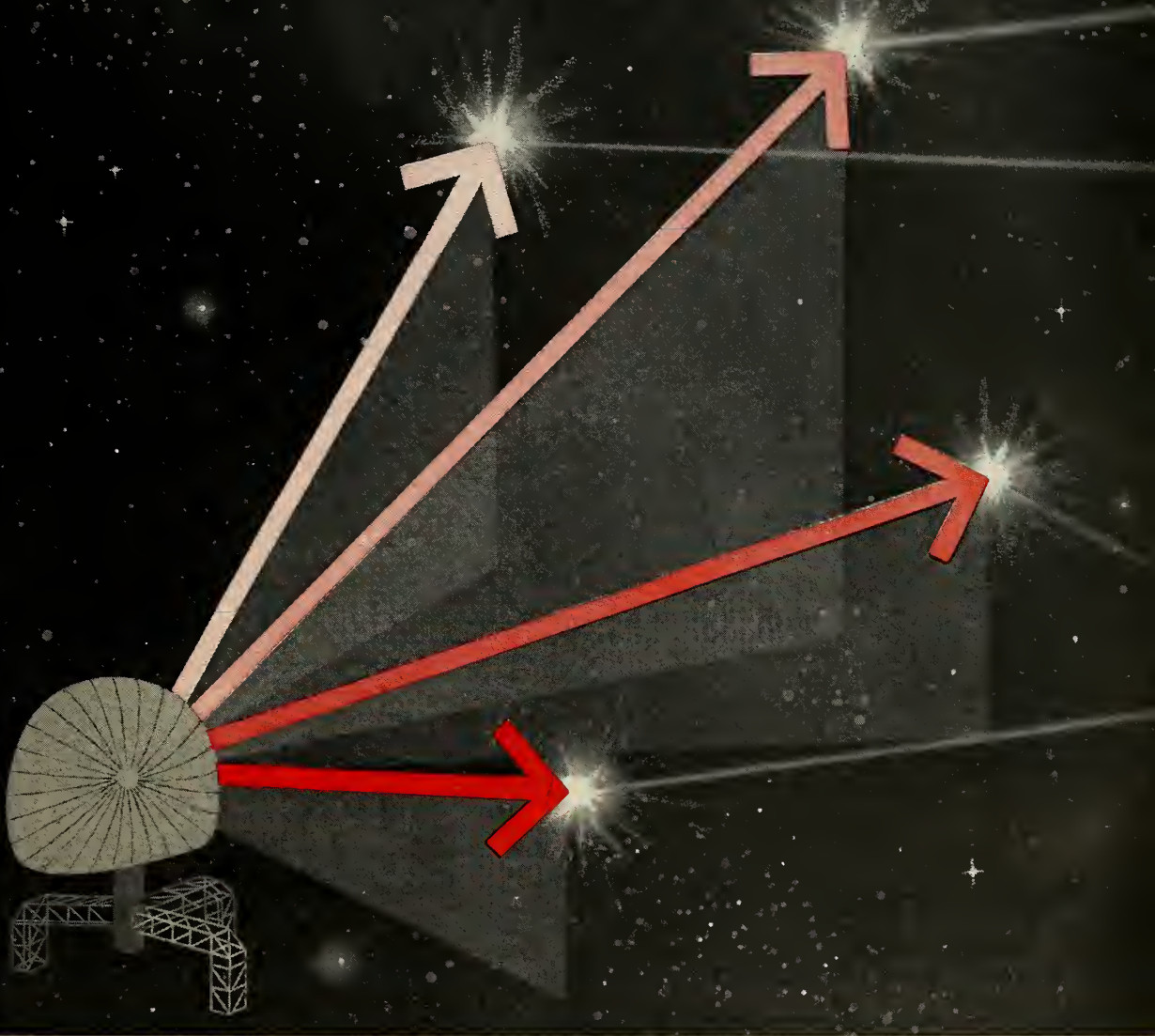

## To get a "3D Fix" with a single radar

Gather range, azimuth and height data fast and accurately through one radar—an established fact with new techniques developed at Westinghouse Electronics Division.

Developments like this go on constantly at the Electronics Division. There the design, development and production of vital military systems and subsystems help to keep the free world ahead.

Westinghouse Electronics Div., P. O. Box 1897, Baltimore 3, Md.

J-02308

**WESTINGHOUSE  
ELECTRONICS  
DIVISION**



**MILITARY SYSTEMS**  
RADAR  
COMMUNICATIONS  
MISSILE CONTROL  
DATA PROCESSING  
AND DISPLAY

YOU CAN BE SURE...IF IT'S **Westinghouse**

Circle No. 10 on Subscriber Service Card.

## ... highway to stars

for an aircraft, but with some of the additional requirements of environmental and damage control, and the necessity for maintaining habitability for relatively long periods of time. In this sense the system becomes a marriage of the aircraft and submarine man-machine systems.

• **Sensor need**—The sensors required will consist of electromagnetic and optical, inertial, force, geometric, quantitative, and chemical. Optical sensors will be used for fixing stars or other light sources such as the moon, earth, and planets to provide azimuth and altitude information to the computer to determine position in space.

This information will be supplemented by electromagnetic sensors for position computation, velocity in space, and detection of obstacles and space debris. Sensors similar to radar and doppler will be used for ranging and approach rates for orbit entry and landing.

Inertial sensors in the form of accelerometers and position storage devices will be used to supply information relative to changes in position

which will aid in position computation, as well as deviations from the trajectory, and will supply information for flight-path control. They will further be used to maintain and control the gravitational state within the space ship.

Force sensors will be used to supply the computer with information for solving the control problem, cabin pressure, thrust, actuating systems, propulsive pressure, and servos.

Geometric sensors will provide information to the computer regarding thrust alignment, direction of auxiliary control jets, azimuth and declination of telescopes for tracking, and other angular measurements.

Chemical sensors will continually analyze the air composition and supply the computer with data for controlling the environment.

Quantitative data such as quantity of fuel, quantity of air, food, temperature, radiation, coolants, etc., will be provided to the computer for proper processing into the various equations.

The computation for the space ship will be accomplished by a central computer capable of continuously solving all of the equations for all systems

such as data presentation, ecological control, flight control, communications.

Such a computer will probably be digital, with parallel logic processing. It must be reliable, with built in essential redundancy and self-healing capability. It will include high capacity memory circuits, high speed computation capability, flexibility, and will probably employ micro-circuitry utilizing solid state techniques to permit maximum capacity.

Much research and development must be carried out before man first launches himself into space. With proper analysis it becomes obvious that since the objective is to put man into space, as a decision maker he must be given the proper information and displays in order to most effectively make these decisions.

But to do this, the space ship must provide him with a proper decision-making environment, the necessary sensors, a central control computer, and the proper controls to carry out his tasks.

With these as necessary parts of the total man-machine system and an integrated adequate display, man will soon be crossing the vast frontier of space by taking his space ship along the highways to the stars.

## TRANSIT CASES *for* MILITARY \* PROTECTIVE PACKAGING

Custom-built transit cases, large or small, from one to thousands. Specially designed protective packaging and shipping cases for electronic or optical components, assemblies or units. Built to Mil T 4734, C 4150, and T 945.



\*Transit cases protect against shock, impact, crushing, humidity, water damage, fungus, and fire. They can be easily carried, flown, floated, stacked, or parachuted, and are tamper-proof. Basic construction of laminated sheet aluminum and plywood, or all aluminum. R. & D. work welcome. Prototypes—2 to 3 weeks. Wire, phone or write for quotations.

Write for Catalog.



**White** AIRCRAFT CORPORATION  
PALMER • MASSACHUSETTS

## ■ ELECTRICAL ENGINEER (RELIABILITY)

Few products require more stringent reliability standards than the electronic, electro-mechanical devices we design, develop and manufacture as a prime contractor for the AEC. This, then, is no routine opening but a key position, utilizing to the maximum your basic reliability theory and your experience in assessing and predicting product reliability. Minimum requirements: EE degree, 7 yrs. experience in design, test or Quality Control work.

To capable men we offer certain unique benefits and inducements which we cannot begin to describe adequately in this brief space. We cordially invite you to investigate your opportunities with Bendix. Your inquiry will receive our prompt, strictly confidential attention. Airmail brief resume to: Mr. A. D. Carr, Professional Personnel, Bendix Aviation Corporation, Box 303-CX, Kansas City, Mo.



KANSAS CITY. MO.



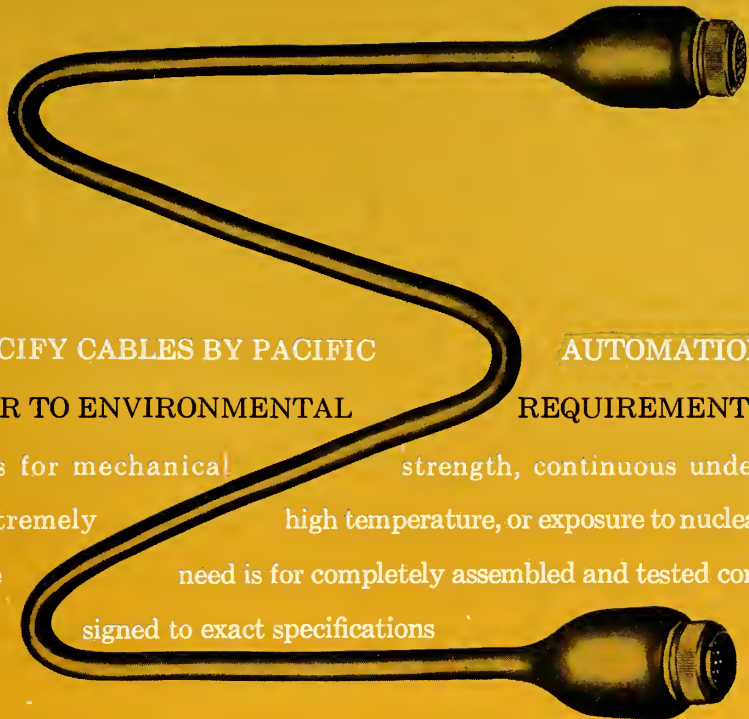

SPECIFY CABLES BY PACIFIC



AUTOMATION



THE TOTAL ANSWER TO ENVIRONMENTAL

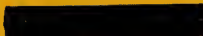

REQUIREMENTS.



Whether the need is for mechanical strength, continuous underwater immersion, extremely high temperature, or exposure to nuclear radiation...whether the need is for completely assembled and tested components, custom designed to exact specifications and ready to be



plugged in—or for bulk cable—PAP offers the right jacketing for every design problem.

  **PAPRENE**—a rugged proprietary compound of neoprene...resists water, red fuming nitric acid, fuels, oils and other corrosive agents. Temperature range: -65°F to 250°F

  **WATERTIGHT**—jacketed in water repellant Paprene and sheathed in stainless steel braid for resistance to rupture. Interstices are filled with a rubber-like compound to eliminate voids

  **PLASTIC**—designed for use in a wide variety of environmental conditions, PAP plastic cable is jacketed in specification grade polyvinyl chloride, or other plastics as required. Temperature range: -40°F to 221°F.

  **HIGH TEMPERATURE**—jacketed in Paprene, protected by heat barriers, interspersed with reflectors, with over-all covering of stainless steel braid. For temperatures of 2,000°F for 45 seconds, 750°F for 15 minutes and 500°F continuously.

  **NUCLEAR**—jacketed in special Paprene to withstand  $10^8$  Roentgens and Gamma radiation to  $10^{19}$  nvt. For complete information, write, wire or phone the nearest PAP office today.

**PACIFIC AUTOMATION PRODUCTS, INC.**, 1000 Air Way, Glendale 1, California, Chapman 5-8661 or citrus 6-2411 / 137 Walnut Hill Village, Dallas 20, Texas, Fleetwood 7-5751 / 626 Jefferson Street, Redwood City, California, Emerson 9-2991 / 420 Lexington Avenue, New York, New York, Lexington 2-5193 / 4355 North Atlantic, Cocoa Beach, Florida, Cocoa Beach, 2059 / *Engineers*: PAP has immediate openings for engineers with specific knowledge of systems requirements of major electronic complexes.





SNORT Track, U. S. Naval Ordnance Test Station

## Bobsleds are bassinets

... compared to supersonic test sleds like these. In firings that duplicate the murderous accelerations and decelerations of space missiles, **ARMA** checks out complex systems of incredible precision and delicacy: airborne digital computers ... inertial navigation equipment ... and other top secret apparatus.

Such systems—designed, tested and produced by **ARMA**—have won **ARMA** an enviable reputation for leadership in advanced electronic and electro-mechanical equipment of utmost reliability. **ARMA** ... Garden City, New York ... A Division of American Bosch Arma Corporation.

5796

**AMERICAN BOSCH ARMA CORPORATION**



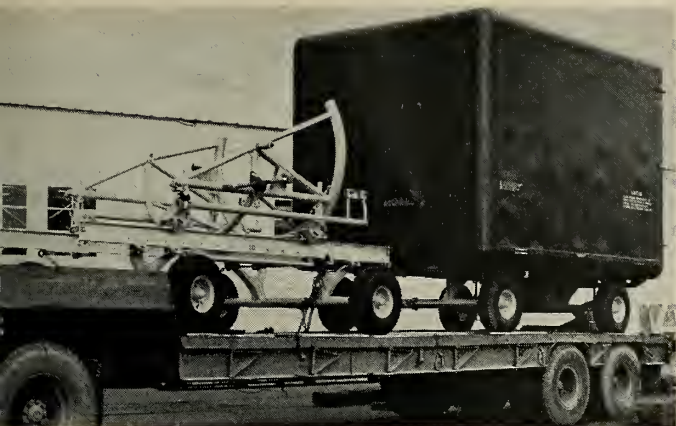

Two-year development program gives Air Force transport capability for IRBM/ICBM components

## Missile Trailer Provides Universal Handling

by Norman L. Baker

The Air Force, after a two year development program, has achieved an air transportability truck transport system for operational IRBM/ICBM equipment.

The new universal handling and transportation system, developed by the Air Logistics Corp., is built around a lightweight-covered trailer incorporating novel loading and unloading capabilities. Only four units are required to meet Air Force requirements for transporting all ballistic missile propulsion components.

The Mobil-Tainer trailer system includes a model for the *Titan* booster engine and the *Thor* main propulsion unit; a model for the *Titan* and *Atlas* sustainer engine, the *Atlas* booster thrust chamber and the *Atlas* booster power package; a transportation trailer; and a standard Air Force workstand trailer. Without modification, the equipment can be used for transporting tanks, nose cones and ducting.

As the result of preliminary investigations at the outset of the program, it was found feasible to develop a universal transportation capability using the standard Air Force trailer equipment. Results of the investigation were later deemed inconclusive and Air Force had to invite various contractors to propose a set of criteria and requirements.

The problem laid out by the Air Force was the transportation, handling and storage of various ballistic missile propulsion system components using standard Air Force and/or other government agency and/or commercial equipment.

This problem was complicated because the liquid rocket type propulsion

system components in the IRBM and ICBM weapon systems are large-volume, low-density, asymmetrically shaped, fragile units which vary in size, form and construction for each system or component. (Illustrations of the package envelopes for these missile systems accompany this article.)

• **Study results**—Early results of this study indicated that the best approach was to design the equipment around the propulsion system components. Minimization of the weight and cost of the system was the next objective of study.

This predetermined optimum system consisted of a universal chassis designed to accommodate a large or small "bed" and cover for the various components. The system designed by Air Logistics and selected by the proposal evaluation committee, included a large bed and cover for the *Titan* booster engine and the *Thor* main engine and a small bed and cover for the *Titan* and *Atlas* sustainer engine and *Atlas* boost, thrust and power package.

The entire program was accomplished in a little over 12 months. This included formulations of basic criteria, submittal to design proposals, evaluation of proposals, awarding of contracts, initiation of system engineering and detail design, establishment of manufacturing facility, development of fabrication techniques, testing, delivery of units on schedule and placement into operational use.

The low weight of the system, dictated by air transportation requirements, was made possible by development of a fibreglass aggregate, called Paraglas. The material is particularly resistant to dents, abrasions, cracking,

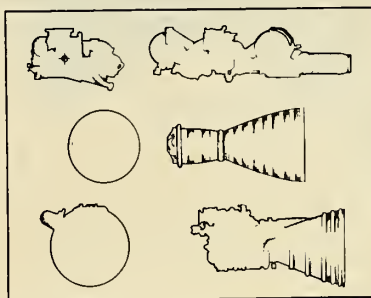

WS 107A SM-65 *Atlas* engine envelopes —XLR 93-NA-1 Booster Power Package (Top); XLR 93-NA-1 Booster Thrust Chamber (Center); XLR 105-NA-1 Sustainer (Bottom)

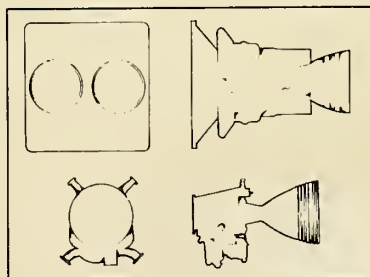

WS 107A2 SM-68 *Titan* engine envelopes —XLR 87-AJ-1 Booster (Top); XLR 91-AJ-1 Sustainer (Bottom)

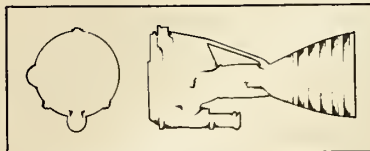

WS 315 A SM-75 *Thor* engine envelope —XLR 79-NA-1 Sustainer.

**50 million**  
**pores per sq. cm.**  
**clean hydraulic**  
**fluids to 0.45μ**  
**absolute**



**New**



Left: Millipore Filter  
 Right: Dense analytical filter paper  
 100 X

**MICROWEB®**  
**FILTER**

This new process volume filter makes available to missile and aircraft engineers the first positive means of eliminating servo valve failures due to dirty oil.

It's a reinforced version of the famous Millipore filter — a unique plastic screen widely used as the first and only means of determining the *exact* nature and *total* extent of particulate contaminants in missile and aircraft hydraulic fluids under provisions of new SAE, ASTM and Military specifications.

MF Microweb filters are now being used to clean hydraulic fluids (1) before storage in tanks (2) on fill/flush/bleed stands both during missile manufacture and field testing and (3) by component manufacturers for flush cleaning and filling. They are also in use filtering critical lubricating oils, ultrasonic cleaning fluids, process air and gases — wherever close-tolerance clarity is essential.

Microweb apparatus, including stainless steel filter holders, can be supplied in standard and special designs.

**Millipore**  
 NEW STANDARD  
 OF PRECISION IN MICROFILTRATION

HERE . . . is the way to get all the facts . . . just clip this coupon to your letterhead . . . sign your name . . . and mail to . . .

MILLIPORE FILTER CORP.  
 Dept. MR, Bedford, Mass.

Circle No. 32 on Subscriber Service Card.

**. . . transportable missile truck**

weathering, synthetic lubricants, fungus, rodents and insects, and appears to meet all flexibility requirements.

Flexibility of the system was a major factor in the determination to eliminate shock mounts, an unheard of decision at the time. Tests utilizing accelerometers mounted in the trailers proved that shock mounts were not required.

Based on this abbreviated test program, shipment of production MB-3 Thor engines was authorized from the Rocketdyne plant in Neosho, Mo. to the Douglas factory in California. Accelerometers mounted aboard for the first trips indicated the vibrations did not exceed the specification requirements.

• **Capability**—The propulsion components in a Mobil-Tainer can be transported in a C-124 aircraft or on a commercial flat-bed truck. The seven major propulsion components are carried in two vehicles. Normally six different containers would be required.

In addition, the system is capable of accommodating vernier engines, tanks and loose ducting which was not possible with other containers. Trailers

are designed for easy accessibility to the components for maintenance and check-out tests.

The universal system is not only applicable to the propulsion systems but to re-entry vehicles or nose cones as well. This standardization of the system for hauling nose and aft ends of the missile systems makes it a high priority item in the Air Force ground support system.

The development of this universal transportation, handling, and storage system for ballistic missile components is monitored by the Propulsion Division of AFBMD and the propulsion group of the Space Technology Labs of the Ramo-Wooldridge Corp. However, each weapons system office, the Strategic Air Command and the Air Force Ballistic Missile Office are all concerned in the successful execution of the program.

All of the weapons systems are now at the same stage of development. Some are in the production phase, some are in the research and development phase. With the development of engine, missile and GSE for these systems considerable success has reportedly been achieved in adapting this universal system to both ends of the missile systems

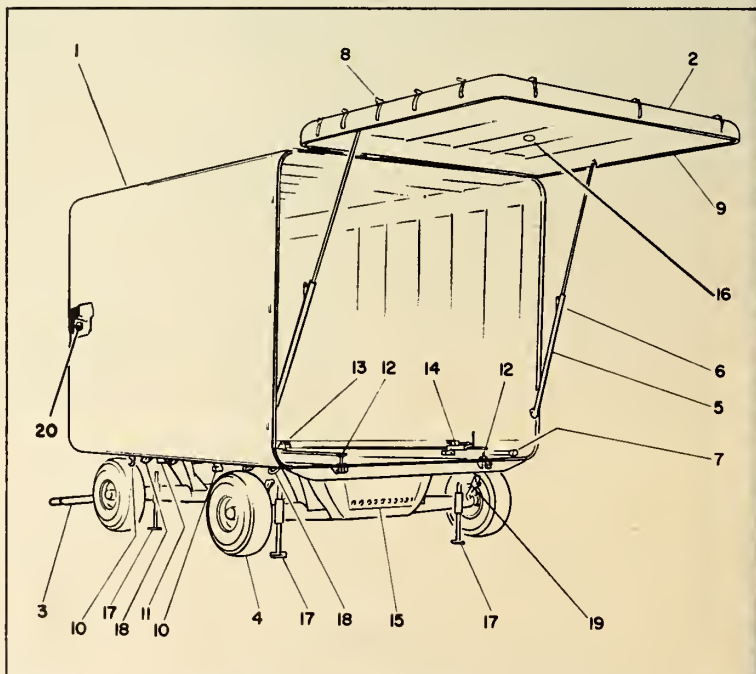

**GENERAL CONFIGURATION of engine system trailer—1) Container; 2) Containe access door; 3) Towbar; 4) Wheels; 5) Telescoping strut; 6) Latch mechanism; 7) Doo pole; 8) External clamps; 9) Seal; 10) Towbar storage brackets; 11) Records container; 12) Rail assembly; 13) Fixed adapter stop; 14) Adjustable adapter stop; 15) Desiccant chamber; 16) Humidity indicator; 17) Jack; 18) Tie-down fittings; 19) Parking brakes; 20) Purge fitting.**



## Plant Opened

### Callery Chemical Ready For Boron Production

by Alfred J. Zaehringer

MUSKOGEE, OKLA.—Boron "exotic" fuels, which in the past have been items of laboratory curiosity, will soon enter the realm of a tonnage chemical here early next year.

In the meantime, Callery Chemical Company is putting the finishing touches on its \$38 million high-energy fuel plant which it will operate for the Navy. The plant, dedicated November 1, will provide many times the production capacity of any known boron fuel plant. Until now, only small quantities of boron hydrides have been available for evaluation in various types of propulsion systems such as turbojets or ramjets.

About two years ago, Callery broke ground on this plant, primarily located here because it offered a cheap source of raw materials and power—both from natural gas. This is because it takes a lot of power to rearrange the boron-hydrogen-and-carbon atoms to form the "Zip" fuel.

An indication of the power requirements for the plant can be gleaned from the fact that although the plant layout is significantly smaller than a conventional refinery, the steam plant is nearly 25 times larger than the steam plant in a petroleum refinery of comparable size. This is where the energy comes from—creation of compounds with higher potential chemical energy. Though Callery has not named its composition, it is felt that the "fuel of the future" is an alkylated boron hydride. A good guess is that the alkyl group in the fuel is an ethyl.

•**Chemical**—Primary raw chemicals are boric acid (shipped in from California's Mojave) and sodium metal which are reacted to form the sodium borohydride. Ethyl alcohol is dehydrated to form ethylene—presumably for the alkylation process.

Nobody will talk about the next phase, but it is generally figured that the borohydride is reacted with boron trifluoride or trichloride to form diborane. It is significant that both Metall Hydrides, Inc., Beverly, Mass., and Stauffer Chemical Co. have maintained close liaison with Callery. Both firms turn out the boron intermediate. Either way, Callery admits that it turns out diborane and has publicly disclosed patents for this process.

Next step comes in the alkylation of the primary diborane. Purpose is to impart more suitable physical properties to the boron hydride—particularly

## Major Southern California missile operation has **immediate openings** for qualified graduate engineers with experience in

### **Instrumentation Systems**

with general knowledge of missile systems, including propulsion, guidance, structures and electrical systems.

### **Guidance Systems**

Experienced in research and testing of practical hardware, and with mathematical background for systems analysis.

### **Flight Test**

Background should qualify for planning and formulating entire flight test programs.

### **Aerodynamics**

Must be able to analyze missile configuration to determine aerodynamic performance and stability and control characteristics.

*For information on these and other engineering positions, write:*

Mr. H. B. Richards, Dept. 451

Missile Division

North American Aviation, Inc.

12214 Lakewood Blvd., Downey, California

**MISSILE DIVISION**

NORTH AMERICAN AVIATION, INC.



## ... Callery readies boron

boiling point and density (The density of Hi-Cal is quite near that of ordinary JP-4, m/r learned from Dr. W. H. Schechter, vice president of operations for Callery.)

• **Skeptical on cost**—According to official Air Force sources here, it is not visualized that the boron fuels will eventually ever get to the \$1/lb category even with large scale production at some distant date. Statements of Olin Mathieson (Olin operates the Air

Force boron fuel plant) about boron fuels getting down in price to \$1/gal are regarded here with a great deal of scepticism. At best, all the production of the boron fuels for some time to come will be used for turbojets (the chemical bombers) with some trickling down to select prototype ramjets.

As far as is known, though offering theoretical gains for rockets, other fuels (such as the hydrazines) will outstrip borons for rocket and outer space use. Dr. Schechter, together with Callery's

working association with Thiokol are, however, swinging around to the belief that boron hydrides may have a big future in solid propellant rockets.

The Muskogee plant has four processing units located on 300 acres of a 1300 acre site. Among the larger units is the \$3.5 million gas plant which produces hydrogen, carbon dioxide, and nitrogen. The nitrogen is used extensively through the plant to provide an inert and protective blanket of gas.

The lower boron hydrides and possibly the intermediates react quite rapidly with the oxygen in the air. For this reason, the plan is laid out according to quantity-distance practices established for the explosive industry.

It is interesting that Mine Safety Appliances, a Callery affiliate, has extensively equipped the plant with chemical fire fighting equipment, protective equipment for plant personnel, and rescue apparatus. Another affiliate, Gulf Oil Co., is also providing processing and administrative know-how.

• **Other facilities**—In addition to the Muskogee plant, Callery also operates a Hi-Cal plant at Lawrence, Kansas, and has administrative and technical centers at Callery, Pa. and Pittsburgh. Recently established with Callery is a liaison representative at Wright-Patterson, formerly with Ballistic Missiles Division.

Total employment at the Muskogee plant will be about 500. Only a small group of technical supervisory personnel was transferred to Muskogee from Callery's Research and Development Laboratories at Callery to provide a nucleus for management and operation of the new plant. Most of the operating personnel are Muskogee area residents whose training and education are especially adaptable to the supplementary training program which Callery has conducted for employees.

"Project Zip" was conceived by the Bureau of Aeronautics five years ago to provide a new fuel which would enable Navy jet planes and air-breathing missiles to fly further and faster with greater payloads.

• **BuAer funds**—The Industrial Planning Division of BuAer provided funds for construction of the plant with administration under the direction of the General Representative, Central District, BuAer. The Kansas City BuAer representative has been directly responsible for contract administration. The Bureau of Yards and Docks has been the authorized representative of BuAer on plant construction, with direct supervision under the Public Works Officer, Eighth Naval District, New Orleans.

## DESIGNED FOR PRECISION PERFORMANCE

**SIMMONS PACITRON LIQUID QUANTITY MEASUREMENT AND MANAGEMENT SYSTEMS** feature the latest technological improvements. Provide accurate gaging of fuel, oil, liquid oxygen and other conductive and non-conductive liquids, as well as many fuel and liquid management functions. Pacitron is currently utilized to control center of gravity within desired limits and to transmit voltage signals for telemetering purposes. Can be adapted to many additional functions which require control within specified limits.

**SIMMONS LIQUID LEVEL SENSING SYSTEMS** provide accurate level indication of hydrocarbon and synthetic liquid fuels, aqua ammonia, LOX, liquid nitrogen, anhydrous ammonia and other liquids. Can be used to operate a warning light or to actuate pumps and valves to transfer liquid at specified levels. System is rugged, has no tubes or moving parts.

**SIMMONS SU FUEL INJECTION SYSTEMS**, the only advanced type of fuel injection system in production for gasoline engines. Offers improved fuel economy and fuel distribution; better starting, idling, acceleration and deceleration; improved cold starts; eliminates icing problems. Ideal for aircraft and drone engine applications.

**SIMMONS PUSH-PULL CONTROLS** are positive, precise and rugged. Simple to install and easy to inspect; require negligible maintenance. Capable of handling heavy loads under extreme vibration and temperature conditions. Variety of sizes and weights available with a wide selection of end fittings and attachments.

**SIMMONS FLUSH-FITTING LATCHES** are flush-fitting on either flat or curved surfaces. General purpose latches for skin mounting or high strength latches for structural mounting. Wide selection of housings and fittings are available. Ideal for securing precision equipment, access panels, nose cones and missile sections.

**SIMMONS BEACONRY** is designed to meet the urgent need for greater reliability in missile location and recovery equipment. Beacon transmits continual signal to permit location and homing. Advantages include increased reliability, greater range, longer operating life.

# Simmonds

**AEROCESSORIES, INC.**

General Offices: Tarrytown, New York

Branch Offices: Glendale, California • San Diego, California • Detroit, Michigan  
Dallas, Texas • Dayton, Ohio • St. Louis, Missouri • Washington, D. C. • Sole  
Canadian Licensee: Simmonds Aeroaccessories of Canada Limited, Hamilton, Ontario

Circle No. 33 on Subscriber Service Card.



## missile people

Appointment of **Brig. Gen. Monro MacCloskey**, USAF (ret.), as assistant to the president, Crosley Division, Avco Manufacturing Corp. was announced recently. Before retiring from the Air Force in June 1957, Gen. MacCloskey was commander of the 28th Air Division (Defense) at Hamilton Air Force Base, Calif. Past assignments include posts as U.S. Air Attache in Paris, and Commander of the Air Resupply and Communications Service, Military Air Transport Service.

**Col. Benjamin G. Holzman**, has been named Commander of ARDC's Air Force Office of Scientific Research (AFOSR) replacing **Brig. Gen. H. F. Gregory**, retired. He was assigned to the Directorate of Research and Development at USAF Hq. from 1947 through 1950 with R&D duties in basic science and atomic energy. During this period he was the meteorologist for the first atomic test in New Mexico and served as staff officer for the 1946 and 1948 atomic tests in the Pacific. In 1955 Holzman became Director of Air Weapons at ARDC Hq. and Director of Research in 1957.

A realignment of the organizational structure of the General Electric Co.'s Missile and Space Vehicle Department has been announced. The following new sections will be coordinated with existing sections to function as a unit.

The re-entry vehicle project operation will be headed up by **Mark Morton**; the space vehicle project operation will be managed by **Howard M. Wittner**. These will work closely with the missile production section, at Burlington, Vt., the aerosciences laboratory and the quality control and test operation.

Flight Sciences Laboratory, Inc., announced these appointments: **Dr. Joel S. Isenberg**, technical director and **Dr. Kenneth Pearce**, **Fred S. Roehrs** and **Robert J. Whalen**, principal scientists.

A new organization designated Weapon Systems has been established at the Douglas Aircraft Co. **Charles R. Able**, former head of Military Sales, was named director "to strengthen the management and direction of company military programs and to meet the challenge of increased competition." Weapon Systems will include the department previously known as Military Sales and will develop integrated plans for future military programs and coordinate their implementation.

missiles and rockets, November 17, 1958

## PROGRAMMED AUTOMATIC CHECKOUT SYSTEM

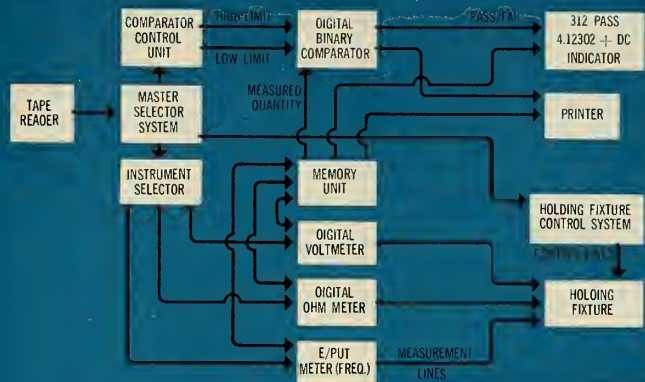

*Tape Programmed—  
Interchangeable Test Fixtures—  
Visual Display and/or Printout—  
Random Control Access—*



*The Robertshaw 500 System*

## REDUCE ELECTRONIC CHECKOUT TIME— INCREASE RELIABILITY

The new Robertshaw 500 System shortens electronic instrumentation test time while assuring reliable checkout using semi-skilled personnel.

More than one million test combinations may be sequenced to cover virtually all checkout combinations. The test instrument is simply placed in the holding fixture and the "Start" button depressed. The ensuing operations are completely automatic and continue until test completion or an unacceptable test measurement is encountered.

As the test cycle commences, a tape reader distributes instructions from a *punched tape* to operational control elements, which 1) control instrumentation, 2) set stimulation, 3) set high and low limits into the *digital comparator*, and 4) establish special *holding fixture* operations. Comparison of test measurements with programmed tolerances is performed by the *digital comparator* and the results presented in a visual GO, NO-GO display form. A printed numerical record of test results is also provided as a permanent log of system operation. Test versatility is afforded through use of various tapes and holding fixtures. Full technical information will be gladly provided upon request.

*Field offices and sales representatives in principal cities.*

AERONAUTICAL AND INSTRUMENT DIVISION

Robertshaw-Fulton CONTROLS COMPANY

SANTA ANA FREEWAY AT EUCLID AVENUE • ANAHEIM, CALIFORNIA  
Circle No. 34 on Subscriber Service Card.

## LINEAR ACCELEROMETER

RELIABILITY  
AND ACCURACY AT  
-65° F  
TO +200° F

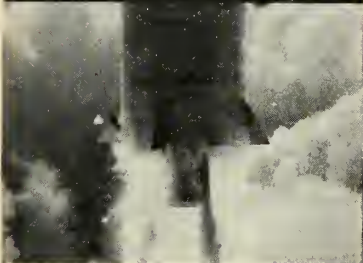

The remarkable *gas-damping* feature of the Model A501 answers critical missile and aircraft testing demands for an accelerometer of accurate, reliable operation over a wide temperature range... *without the use of a heater jacket.* The Model A501 produces flat up to 500 cycles per second-reliable signals for rapidly changing acceleration.

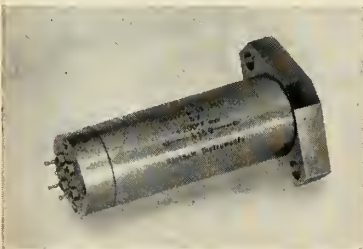

Range:  $\pm 5$  to  $\pm 50$  g  
Excitation: 5 volts DC or AC (rms)  
Output:  $\pm 20$  millivolts  
Non-linearity and Hysteresis:  
Not more than  $\pm 1\%$  full scale  
Weight:  $6\frac{1}{2}$  ounces

For detailed technical data to answer your needs,  
write for Bulletin A501TC.

# Statham

INSTRUMENTS, INC.

accuracy / integrity / reliability

12401 W. Olympic Blvd., Los Angeles, Calif.  
Circle No. 35 on Subscriber Service Card

# Automatic Testing Cuts Costs

by Norman L. Baker

Missile test equipment for heavy flow manufacturing, long a laborious production bottleneck, has moved to an "honorable" position at the end of the assembly line. Hughes Aircraft Co. is currently saving thousands of dollars each month in its *Falcon* air-to-air missile production program by utilizing automatic assembly line test equipment.

The test device, apparently the first in the country, is known as the Aircraft Missile Weight and Balancing System. Designed and built by the Electronics and Instrumentation Division of the Baldwin-Lima-Hamilton Corp., the equipment determines the center of gravity and thrust alignment of the *Falcon* directly with extreme accuracy.

The system assesses each missile by certain pre-set standards for weight, longitudinal CG, lateral CG and thrust alignment. Measurements are recorded automatically on a paper called a Weight and Alignment Data Chart. Consisting of two major units, the equipment performs the following operations:

- 1) Measures the weight of the missile (accuracy of 0.1016).
- 2) Determines longitudinal CG (accuracy of .015).
- 3) Determines lateral CG (accuracy of .002).
- 4) Measures thrust alignment (accuracy of .002).
- 5) Repeats measurements on missile (accuracy of .0005).

All the above measurements are completed in about five minutes.

Prior to installation of the new equipment, the *Falcons* were checked out by mechanical test apparatus. The quality control instrument was realized by development of two radical sensing elements and a standard load cell.

• **Systems Operation**—As the *Falcon* leaves the production assembly line, an overhead monorail picks up the missile and lowers it horizontally by hoist onto the test platform. It is aligned on the platform by a pin which fits into a tooling hole in the missile.

After the *Falcon* has been lined up horizontally, the operator presses a button on an adjoining electronic console, lowering the missile on a cradle mounted on a load cell which weighs it. The operator then turns the manual programming switch to a set position measuring the longitudinal CG which is printed on a chart. The switch is a large metal disc that permits the operating buttons to be pressed only in the correct sequence.

Following the longitudinal CG and weight recording on the chart, the data is removed from the printer and placed in a plotter for recording the lateral CG and thrust alignment. Two measurements, made while the missile is still in its horizontal position, determine the lateral CG.

An initial measurement—lateral CG "X"—is made. The missile is then rotated 90 degrees around its long axis, and a second measurement—lateral CG "Y"—is made. The summation of these two readings are recorded as the lateral CG reading.



AIR HOIST guides *Falcon* onto platform for automatic assembly line testing.

missiles and rockets, November 17, 1958

Circle No. 11 on Subscriber Service Card. —>



Lightweight . . . only 8.5 oz.  
 Superior Linearity and Hysteresis Characteristics  
 Two Stage . . . First Stage Separable Assembly  
 Rotary Coils  
 Adjustable Nozzles  
 .5 or 5 gpm Models at 3000 psi  
 100% Differential Current for Rated Flow  
 Self-Cleaning Air Gaps  
 Maximum Reliability  
 Corrosion Resistant Metal and Magnetic Filters  
 Easier Field Servicing



ACTUAL SIZE

**New**

**VICKERS**

# SERVO VALVE

Designed primarily for aircraft and other applications, the new Vickers Aero-Hydraulic Servo Valve has numerous features (see above) to assure optimum performance and dependability.

By directing modulated flow to linear and rotary actuators with respect to minute input current has been minimized within a small envelope at a weight that is approximately 30% less than other valves of similar capacity. Design also provides for interchangeability with existing servo valves now used in airborne applications. For further information, ask for technical bulletin number SE-98.



Packaged with Vickers standard (left) or miniaturized (right) piston type hydraulic motors, the assembly provides excellent performance with the added advantage of single-source responsibility.

## VICKERS INCORPORATED

DIVISION OF SPERRY RAND CORPORATION

**Aero Hydraulics Division • Engineering, Sales and Service Offices:**

ADMINISTRATIVE and ENGINEERING CENTER  
 Department 1470 • Detroit 32, Michigan

TORRANCE, CALIFORNIA • 3201 Lomita Boulevard  
 P.O. Box 2003 • Torrance, California

Aero Hydraulics Division District Sales and Service Offices • Albertson, Long Island, N.Y., 882 Willis Ave.  
 Arlington, Texas, P.O. Box 213 • Seattle 4, Washington, 623 8th Ave. South • Washington 5, D.C., 624-7 Wyatt Bldg.

Additional Service Facilities at: Miami Springs, Fla., 641 De Soto Drive

TELEGRAMS: Vickers WUX Detroit, TELETYPE: "ROY" 1149 • CABLE: Videt  
 OVERSEAS REPRESENTATIVE: The Sperry Gyroscope Co., Ltd.—Great West Road, Brentford, Middx., England

# TANTALUM Sheet

## FROM STOCK

"As fast . . . as dependable as requisitioning from our own stock room." That's what hundreds of firms say about the Fansteel Tantalum Sheet Stocking Service.

Delivery of Fansteel Tantalum Sheet from stock has helped many customers to accelerate research and development programs . . . speed up prototype work and pilot runs . . . and to get into production without delay.

### FANSTEEL SERVICE SAVES TIME AND MONEY

If you're now working on new projects using tantalum or are stepping up production schedules, let this Fansteel Service help save you time and money by giving you the flexibility of quick deliveries and lower inventory costs.

MOLYBDENUM USERS get the same benefits from the Fansteel Molybdenum Sheet stock program.

IMMEDIATE  
DELIVERY  
ON THESE  
FIVE  
MOST USED  
SIZES OF  
TANTALUM  
SHEET

.002"  
.003"  
.005"  
.007"  
.010"

### WE'LL RUSH YOU PRICE BULLETIN

Call, wire or write for new price bulletin just released. Contains complete prices for both tantalum stock items and special mill runs.



## FANSTEEL®

TANTALUM • MOLYBDENUM • COLUMBIUM • TUNGSTEN

FANSTEEL 77 METAL

### FANSTEEL METALLURGICAL CORPORATION

NORTH CHICAGO, ILLINOIS, U.S.A.

## when and where

### NOVEMBER

- American Society for Quality Conference**, Sixth Annual Aircraft and Missile Division Conference, Biltmore Hotel, Dayton, Nov. 17-18.
- American Rocket Society**, 13th Annual Meeting and Astronautical Exposition, Hotel Statler, New York, N.Y., Nov. 17-21.
- Eighth National Plastics Exposition**, International Amphitheatre and Plastics Conference, Hotel Morrison, Chicago, Ill., Nov. 17-21.
- Northeast Electronics Research and Engineering Meeting**, Mechanics Hall, Boston, Mass., Nov. 19-20.
- Lockheed Missile Systems Division's Research Laboratory**, Third Symposium on Magnetohydrodynamics, Palo Alto, Calif., Attendance by invitation, Nov. 21-22.
- The Convertible Aircraft Congress**, Franklin Institute, Philadelphia, Nov. 28.
- First Electronic Computer Exhibition and Symposium**, Olympia, London, England, Nov. 28-Dec. 4.

### DECEMBER

- Third EIA Conference**, Reliable Electrical Connections, Dallas, Texas, Dec. 2-4.
- IRE and AIEE**, Second National Symposium on Global Communications, Colonial Inn, St. Petersburg, Fla., Dec. 3-5.
- Eastern Joint Computer Conference and Exhibit**, Bellevue-Stratford Hotel, Philadelphia, Penna., Dec. 3-5.
- Mid-American Electronics Convention**, sponsored by Kansas City Section, Institute of Radio Engineers, Municipal Auditorium Arena, Kansas City, Mo., Dec. 9-11.
- American Astronautical Society**, Fifth Annual Meeting, Hotel Statler, Washington, D.C., Meeting will be held in conjunction with the 125th Annual Meeting of the American Assn. for the Advancement of Science, Dec. 27-30.

### JANUARY

- Fifth National Symposium on Reliability and Quality Control** in Electronics, Bellevue-Stratford Hotel, Philadelphia, Penna., Jan. 12-14.
- Society of Plastics Engineers**, 15th Annual Technical Conference, Hotel Commodore, New York, N.Y.

### MARCH

- IRE, AIEE and Association for Computing Machinery**, 1959 Western Joint Computer Conference, Fairmont Hotel, San Francisco, Calif., March 3-5.



# DETECTION

**LMED'S** airborne **GENDARME\*** will illuminate the unknown

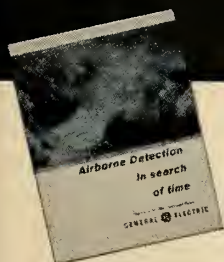

One or many, in clouds or clutter . . . nothing will elude GENDARME, LMED'S new \*Airborne Early Warning and Control radar. New AMTI (Airborne Moving Target Indication) and Pulse Compression techniques sharply curtail sea clutter, improve target detection. New "built-in" height finding provides a truly 3-D search system. New data processing methods insure completely automatic operation. For further news on LMED's detection developments write for brochure: "Airborne Detection . . . in Search of Time," Dept. 7M

**LMED**  
LIGHT MILITARY ELECTRONICS DEPARTMENT

*Progress Is Our Most Important Product*

**GENERAL  ELECTRIC**

LIGHT MILITARY ELECTRONICS DEPARTMENT  
FRENCH ROAD, UTICA, NEW YORK

A DEPARTMENT IN THE DEFENSE ELECTRONICS DIVISION  
Circle No. 12 on Subscriber Service Card.

# Pioneer's

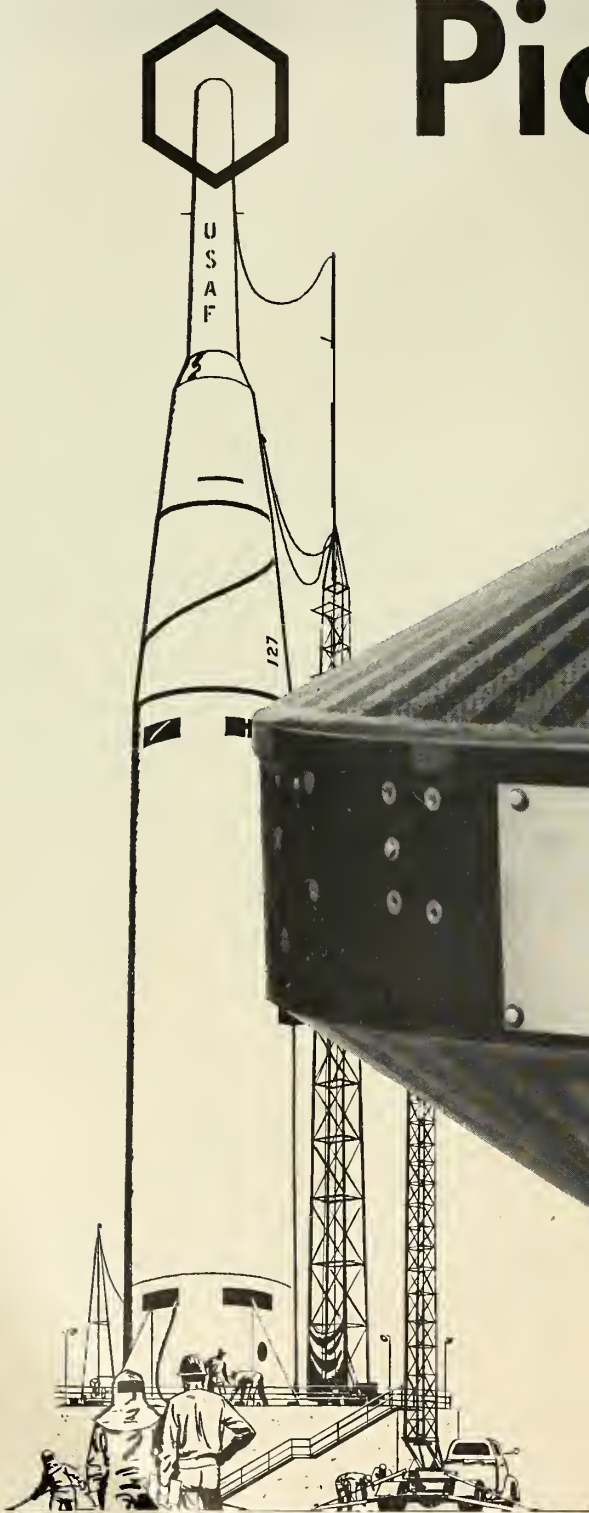



# Honeycomb

*by the pioneer in honeycomb*

## HEXCEL

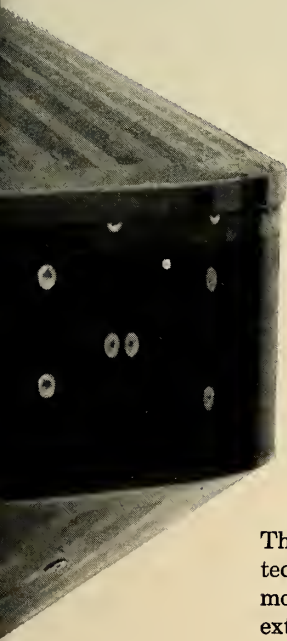

HEXCEL—world leader in honeycomb, basic source  
for aluminum, stainless, glass fabric and cotton  
honeycomb . . . largest tech service staff . . . R & D  
trailblazers . . . high temperature honeycomb  
pioneers . . . product superiority from patented  
processes, special machinery . . .  
largest manufacturing facilities.

The complex instrumentation of Pioneer was contained and protected by Hexcel fibreglass honeycomb. This sandwich structure, molded by Summit Industries of Gardena, California, gave Pioneer extraordinary strength with an absolute minimum of weight.



**HEXCEL<sup>®</sup> PRODUCTS INC.**

*World leader in honeycomb...now first in space*

Home Offices: 2332 Fourth Street, Berkeley 10, Calif.

Plants: Oakland and Berkeley, Calif.; Havre de Grace, Md.

Circle No. 13 on Subscriber Service Card.

# DATA PROCESSING SYSTEM SPECIALISTS

the techniques of high speed data processing offers a big future for you

A missile comes "of age"—reaches operational status—as a result of many influences. Vital among these influences is the rapid incorporation in the test vehicle of modifications required by evaluation of flight performances. The faster these modifications are made, tested, and become incorporated in the design the faster the vehicle is declared operational.

The completion of this cycle is dependent too upon the speed with which vast amounts of test data can be reduced, analyzed, evaluated, and reported to the military and to the cognizant weapon systems contractors.

So, with the advent of missiles has come a revolution in data processing techniques—a revolution in which the Engineering Services of Telecomputing Corporation has been highly successful in greatly reducing the elapsed time for complete processing of missile flight test data.

This is an invitation to join the data processing specialists who comprise the Engineering Services Staff—a Staff which establishes the state-of-the-art in data processing techniques and methods as we go about our job of computing the performance of missiles under test at the White Sands Missile Range.

Join us and work with high speed digital computers and other modern data processing equipment in reducing the test data from scientific data measuring systems such as, cinetheodolites, electronic measuring systems, precision optics, and telemetering systems.

Join us—and grow with us—as our advanced processing techniques are employed in this fascinating field of missile flight testing so important to our national defense effort.

Make your home in New Mexico's land of enchantment—mountain skiing and resorts just 30 minutes away—attractive salaries with area bonus—profit sharing—relocation pay—group insurance. Send your resume today to the Director of Technical Personnel.

engineering service division  
**TELECOMPUTING  
CORPORATION**

Box 447, Holloman Air Force Base,  
New Mexico

## space age

by Norman L. Baker



The unexpected discovery of the high altitude radiation belt, with the resultant concern for future manned space travel, has almost overshadowed the other invaluable findings made by the *Explorer* satellites. First, micro-meteorite impact detectors have substantiated beliefs that these small particles will not offer a hazard to space vehicle structures. Temperature measurements have shown that the environment of a space cabin can be controlled to a comfortable level by proper selection and proportion of exterior radiating materials. It is known, for instance, that the density of the atmosphere at 200 to 300 kilometers is about 40% higher than was originally anticipated.

Precise tracking of the satellites has also given a more accurate profile of the earth's sphere. It is apparently  $\frac{1}{2}$  to 1% less curved than previously thought. Irregularities in the satellites' velocities indicate enormous air mountains which are constantly changing due to the sun's radiation.

The nuclear power space programs, Project Rover and Project Snap, are reporting excellent progress and confidence for an early development breakthrough is exceedingly high. Project Rover will use a solid-fuel nuclear reactor to heat a light propellant-like hydrogen to extremely high exhaust velocities.

First rocket reactor will probably be a graphite core loaded with uranium and surrounded by a beryllium oxide reflector. Hydrogen will be drawn through the reactor, undergo tremendous expansion and then move out through the nozzle. Temperatures in the reactor will be in the 4,000 to 5,000°F range.

The development of an auxiliary nuclear power source for satellites, Project Snap, is actually three programs. *Snap I* is the use of radioactive isotopes as a heat source with Martin as the prime contractor. Cerium 144 is being used as the heat source. *Snap II* is an Atomics International thermal reactor. *Snap III*, a project by Westinghouse, is an extremely small power source—weight less than 10 pounds, but will develop three watts of electrical energy for six months.

Major breakthrough in storable liquid packages may soon make these units available for space vehicles. Reaction Motors has successfully tested a 50 k package for 5.7 seconds. Unit was scaled-up from the *Bullpup Guardian* engine. This size package should be ideal for a second stage section of a *Thor-Able*-type of vehicle. The storable liquid package rocket had its beginning in World War II with the German *Taifun* surface-to-air rocket.

Controlled nuclear explosions for space-propulsion power is under investigation by General Dynamics Corp's General Atomics Division. General Atomics study differs from others because it uses a series of controlled detonations for power within the atmosphere and beyond.

missiles and rockets, November 17, 1958



# CONTROLS

FOR THE FULL SPECTRUM OF PROPULSION SYSTEMS

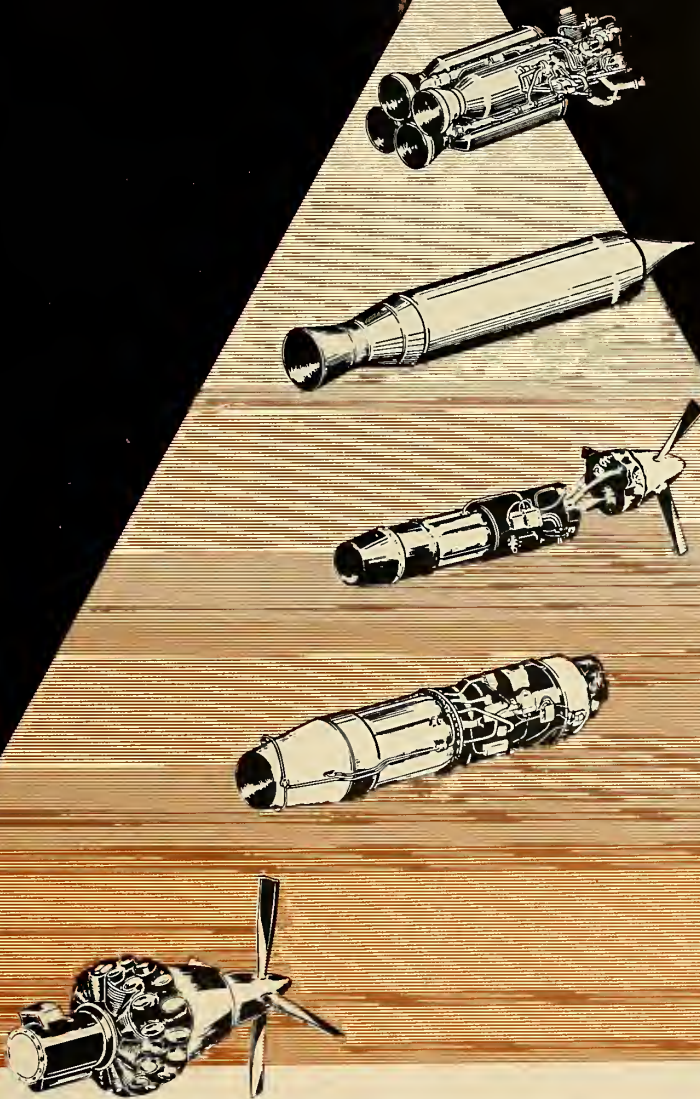

Bendix\* has long been a leader in supplying controls and fuel systems for all types of aircraft engines. Today, Bendix is proving to be a natural for new challenges in related missile fields—on ram jets, rockets, nuclear power, and other advanced propulsion systems. So, when it comes to controls, remember that Bendix has the background—and is anxious to share it in solving your problems. \*REG. U.S. PAT. OFF.

**BENDIX** PRODUCTS DIVISION **SOUTH BEND, IND.**



Circle No. 14 on Subscriber Service Card.



## Chemical-Loaded Molecular Sieves — Latent Curing Aids in Rubber and Plastics

Rubber and plastics fabricators need faster curing systems. The use of more active agents for rapid curing reactions has been restricted, because their use generally results in formulations difficult to process and store. This problem is serious at the high temperatures reached during the processing of rubber formulations. A novel series of latent curing aids, called LINDE Chemical-Loaded Molecular Sieves, now make it possible to use these active compounds to obtain faster, more effective curing systems, while still maintaining processing safety.

In LINDE Chemical-Loaded Molecular Sieves curing aids are "locked" within the pore structure of the Molecular Sieves by strong adsorptive forces. The active compounds, when loaded on Molecular Sieves, are effectively isolated from the rubber or resin formulation during processing and storage. However, at curing temperatures, which are generally higher than processing temperatures, the active compound is released from the Molecular Sieve to accelerate the curing reaction.

In this way, Loaded Molecular Sieves permit the use of highly active compounds to obtain fast cures, without sacrificing processing safety or pot life. Now, even vulcanization agents previously considered too active or volatile for practical use, may be used with processing safety.

Chemical-Loaded Molecular Sieves can be used as latent accelerators and curing agents in a variety of rubber and plastics formulations including styrene-butadiene rubber, natural rubber, Neoprene, nitrile rubber, epoxy resins, rigid vinyl plastisols and others. Loaded



Molecular Sieve CW-2015 (di-tertiary butyl peroxide) is being used commercially in the curing of silicone elastomers and rigid vinyl plastisols. Loaded Molecular Sieves are now being investigated by many processors of rubber and plastics in such items as tires, mechanical goods, hose, belting and footwear. For further data, write to Molecular Sieves Department 0000, LINDE COMPANY, Division of Union Carbide Corporation, 30 East 42nd Street, New York 17, N. Y.

## Radioactive Krypton

Krypton 85 is a radioactive isotope of the inert atmospheric gas, with a half-life of 9.4 years.

Radioisotopes such as Kr-85 are relatively inexpensive and new uses for them are being found every day.

One application is in tracer element testing of hermetically sealed encapsulated transistor devices. Another is in an "external" non-electric illuminating lamp which uses Kr-85 to activate a phosphor coating on the inside of a glass globe. Studies at the National Institute

of Health have shown that Kr-85 can be used to detect abnormal heart openings. 99 per cent of Kr-85 radiation is non-penetrating, quite safe, even for repeated exposures.

LINDE is marketing Kr-85 as an additive to non-radioactive rare gases (argon, helium, neon, krypton and xenon) individually or as mixtures. LINDE does not sell Kr-85 in pure or concentrated form. The other rare or inert gases, with Kr-85 added, will normally be available only in Atomic Energy Commission-approved, specially-marked cylinders.

Purchasers must be licensed by local or regional A.E.C. offices except for purchases of one microcurie or less. Non-licensed purchasers of one microcurie each may have 10 such cylinders on hand at a time.

LINDE's price for Kr-85 additions will be based on the radioactive level

of the gas mixture expressed in millicuries of activity (N.T.P.) per liter. For additional information, write to Rare Gas Department 0000, LINDE COMPANY, Division of Union Carbide Corporation, 30 East 42nd Street, New York 17, N. Y.

## Three-Level Ruby Maser

The Maser is a microwave amplifier utilizing energy stored in a molecular or atomic system. Emission of this energy is stimulated by the input signal. Masers operate at liquid helium temperatures and have incredibly low noise levels approaching zero db. Recently a University research laboratory\* used



LINDE single crystal synthetic ruby ( $Al_2O_3$  with  $Cr_2O_3$  additive) in a three-level solid state Maser. The ruby crystal was placed at the center of the Maser's tuned cavity and a magnetic

field of 4200 gauss was applied. To bring electrons from a ground state into a permissible higher energy level, a pumping frequency of 24 kMc was used and the Maser successfully amplified signals at 9.3 kMc.

LINDE also supplies other crystals including rutile, spinel and sapphire ( $Al_2O_3$ ). Sapphire is used in infrared optical systems, windows for high power microwave tubes, spacers and supports in vacuum tubes, radiation pipes. It has strength at elevated temperatures, melts at 2040°C, is hard, inert, non-porous and can be sealed to metals and glasses. Sapphire is currently available in the shape of domes, windows up to 4½ inches in diameter, rods and special configurations.

For further data write to Crystal Products Department MI113, LINDE COMPANY, Division of Union Carbide Corporation, 30 East 42nd Street, New York 17, New York.

\*"Maser Action in Ruby," by G. Makhov, C. Kikuchi, J. Lambe, and R. W. Terhune. "Physical Review," Volume 109, Number 4, Page 1399, Feb. 15, 1958.

PRODUCTS WITH A FUTURE

*Linde*  
TRADE MARK

UNION  
CARBIDE

The terms "Linde" and "Union Carbide" are registered trade-marks of Union Carbide Corporation.

Please designate product which interests you

Circle No. 15 on Subscriber Service Card.

missiles and rockets, November 17, 1958





# keeping track

by Peer Fossen

Things are really being rushed to complete the Goldstone Tracking Facility at Camp Irwin, Calif., in time for Army's first lunar by-pass shot. Construction crews have for some time been working seven days a week in two 10-hour shifts per day. The project, which was started in July, is under Jet Propulsion Laboratory's supervision and includes the following principal contractors: The Blaw-Knox Co., Pittsburgh, Pa., Radio Construction Co., Pittsburgh, Pa., Collins Radio Co., Cedar Rapids, Iowa, and the Rucker Co., Oakland, Calif.

Principal component of the Goldstone Tracking Facility is an 85-foot in diameter, 110-foot high parabolic antenna, focusing received radio waves to a point where the pick-up antenna or a radio receiver is located. The all-steel dish has an east/west declination angle of 180° and slightly less—160°—for north/south tracking. When put into operation the antenna will be capable of receiving signals from space vehicles up to 400,000 miles distant. By increasing antenna efficiencies as well as the power and size of the transmitters in space, tracking range could be extended to 40,000,000 miles by 1960 and to 4,000,000,000 by 1962.

University of Michigan's ruby maser (m/r October 6, p. 25) is being fitted into the plans for the 85-foot radio telescope under construction by the University at Peach Mountain, near Dexter. In the ruby maser, which operates at temperatures near absolute zero, the internal atomic motion noises found in ordinary vacuum tubes and transistors are almost silenced, making possible amplification of extremely low-level signals.

This column's report of October 20 on Britain's progress in the development of infrared devices for detection of missile launchings up to 1000 miles away failed to excite U.S. scientists in the IR field. One Westinghouse scientist said: "We suggested an IR detection system more than two years ago. The system, working from a satellite, would be capable of detecting an ICBM in its early climb, and telemeter the information back to a ground station. However, for lack of support, the project was shelved until work was recently resumed."

Westinghouse has been in the IR field since 1942 when the company built an IR communication system for the Navy. One of the current projects involves the development of an IR imaging tube known as the Thermicon. The tube works much like a TV scanning tube, but is sensitive to IR radiation rather than visual images.

The Air Force recently asked industry for information on nuclear batteries for power supply in space vehicles. One answer appears particularly promising. The company said it could produce an isotope-bank type battery weighing 100 lbs., and yielding 300 watts for 2.5 years; current efficiency about 8% with an expected increase to 15%, maybe 25%, before long. There was, however, one catch. The high price of isotopes would bring the total cost of one battery up to \$10 million. The Air Force is still looking.

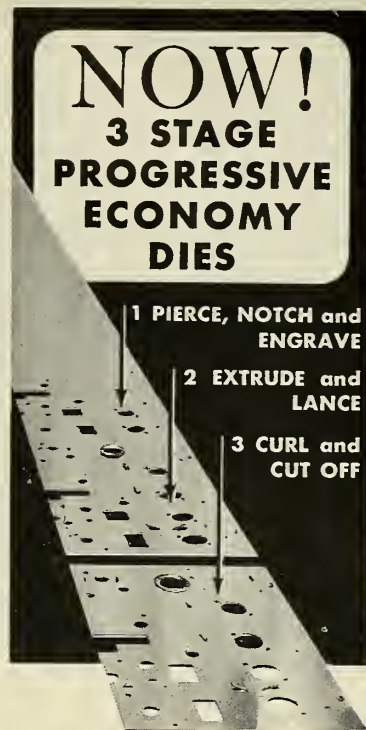

## Savings

— YOU CAN SEE —

die material cost	\$63
tooling time	45 hours!
set-up time	10 minutes!
over 5000 pieces per day!	
(hand feed, 8x6", 20 ga. CRS)	

Now you can benefit from economy tooling for compound, progressive and other types of tool designs.

Parts are produced in any gauge or material by means of Templet tooling processes — at substantial savings.

*Submit prints  
for quotations*



The Templet Process (Pat. Nos. 2,495,221 and 2,850,096) is also available for use in your own shop. Now licensed to more than 150 major U.S. manufacturers. Write for details. Circle No. 38 on Subscriber Service Card.

*Marquardt*

# ADVANCED POWER SYSTEMS

FOR AIR AND SPACE

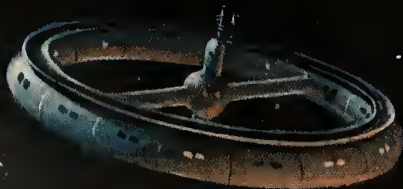

Projects meeting the ever increasing needs of Advanced Power Systems for Air and Space operations are currently under way at Marquardt. Here, in an environment that stimulates creative hypotheses, Marquardt engineers and scientists are engaged in the following diversified areas:

#### **ADVANCED PROPULSION CYCLES**

- Ramjets for cruise propulsion for hypervelocity missiles and piloted aircraft and as accelerating devices for Space Vehicles
- Electrical Propulsion—Plasma Jets, Ion Propulsion and Magnetohydrodynamics
- Nuclear Ramjet

#### **EXOTIC FUELS**

- Evaluation—Energy, Compatibility and Logistics

#### **CONTROLS & ACCESSORIES**

- Hot Gas Servo Systems
- Accessory power for Space application
- Variable geometry Inlet Controls

In addition, current application projects include supersonic ramjet power for Bomarc, Super Bomarc, X-7 (test vehicle), Q-5, and Kingfisher.





**TO ENGINEERS AND SCIENTISTS:**

Engineers capable of contributing to advances in the state-of-the-art and scientists who desire to do proof-of-the-principle research in the fields of propulsion systems, automatic controls, advanced test facilities and high temperature materials may find, here at Marquardt, the climate best suited to your interests and talents. May I suggest that you contact me?

Roy E. Marquardt  
*President*

*Marquardt*  
**AIRCRAFT CO.**

VAN NUYS AND POMONA, CALIFORNIA • OGDEN, UTAH

# New Army Missiles Revealed

by William O. Miller

The Army is moving ahead rapidly to provide frontline troops with a complete spectrum of missiles to provide the mobility, speed and firepower required in the space age.

These missiles range from a surface-to-air bazooka to the 500-700-mile range *Pershing*. While progress in several areas is still at the feasibility study level, the Army has high hopes of early equipment availability to match its established pentomic organization. To the missile industry it will mean a reported expenditure of \$5-billion annually for perhaps three years.

Outstanding systems at the divisional and below levels are *Missile Able*, *Mauler* and *Redeye*. *Redeye*, in the feasibility study stage, is a surface-to-air bazooka. Man-portable, *Redeye* will employ infrared guidance to home on low-flying aircraft and helicopters.

*Missile Able* is a field artillery missile to provide direct support to the battle group. Prime requisites for this surface-to-surface missile are that it be light-weight, with a high degree of accuracy and mobility.

Feasibility studies for *Missile Able* are being carried out by six companies who have been given study contracts of about \$60 thousand each. They are General Electric, Minneapolis-Honeywell, Armour, Cornell, Martin and Douglas. Chance-Vought has been carrying out an unfunded study with \$6-million in its own funds for another version, reportedly named *Rattler* or Project Firepower, which it expects to test in mid-January (m/r, Nov. 3, p. 7) *Missile Able* will have about a 70-mile range.

The Army expects to receive the reports from contractors by early 1959. Progress reports thus far have failed to indicate whether *Missile Able* will employ inertial guidance or be a free rocket. Whoever wins the competition can expect orders in large numbers.

*Mauler's* infrared system will give troops surface-to-air offense with six missiles per unit.

Successor to the now-defunct *Dart* will not be the French *SS10* or *SS11* as commonly believed, but will probably wind up in a competition between the German-developed two-stage *Kobra* and the *Vickers 891* now under evaluation by a major U.S. defense contractor.

Backing up *Kobra* will be some version of the atomic bazooka popularly known as the "Gavin Grapefruit" or the "Trudeau Turnip."

Next in line is the mobile *Lacrosse* which will be available at the division or corps level. In this case, a corps will mean three divisions. These are the pentomic divisions which are being organized to be self-sustaining on a wide front.

Along with *Lacrosse* will be the free-flight *Little John* utilized by STRAC (Strategic Army Corps) and by the Army's air mobile divisions.

*Honest John* would be available to front-line troops at the division level.

Thus, the Army missile line-up is: *Redeye*, *Cobra*, *Missile Able*, *Little John*, *Honest John*, *Lacrosse*, *Corporal*, *Sergeant*, *Redstone* and *Pershing*.

In *Pershing*, the Army expects to eliminate many shortcomings of its forerunners by an advanced modular concept, solid propellant, increased mobility and improved field handling and maintenance.

While nuclear warheads are being considered for some of these weapons, Army planners say that a "tailored payload," both as to size and nature, is a major consideration. While the "big bang" in the smaller package may be desirable from many viewpoints, radiation, blast effect, and fallout must be carefully weighed when nuclear weapons are used at short ranges.

## Bloodhound Goes Into Operational Service

Great Britain has begun placing its Bristol—Ferranti *Bloodhound* SAM in operational service, installing the first weapons at North Coates in Lincolnshire. The station is a fully operational installation and will include a permanent trials unit concerned with evaluation of the *Bloodhound* system.

The missile, using a semiactive guidance system, is reported to have the longest range in the world for its type. Four solid-propellant rocket motors accelerate the missile to supersonic speed, at which point the ramjet engine takes over. At a certain airspeed, the booster rockets are separated from the missile by air drag and jettisoned. The *Thor*-type ramjet burns kerosene as fuel.

The *Bloodhound* will be used by the RAF and the Royal Swedish Air Force, and is already in mass production by six plants, requiring a labor force larger than that for any comparable project in Western Europe. Working with the Guided Weapons Division of Bristol Aircraft Ltd. on the *Blood-*

*hound* are Bristol Aero-Engines Ltd., Ferranti Ltd., The British Thompson-Houston Co. Ltd., E.M.I. Electronics Ltd., Decca Radar Ltd., and M. L. Aviation Ltd.

In an effort to provide the best possible development potential, Bristol and its team members designed the missile with a monoplane moving wing missile frame and a ramjet powerplant. The missile frame design incorporates a moving wing configuration, enabling it to navigate through a twist and steer maneuver and thus affording high performance at high altitudes. The lift is obtained rapidly and directly from the wing surfaces, with a minimum of change in missile body incidence.

The *Bloodhound* is a complete weapon system, incorporating target-illuminating radar, control posts, and launchers. All integral components are designed for minimum maintenance and long periods of service.

As a result of its *Bloodhound* program, Bristol has recently opened a high-altitude test facility to allow free jet testing of ramjets at simulated altitudes up to 100,000 feet.

## Soviet Moon Rocket Has Half-Ton Payload

A payload about the size of *Sputnik II* will be carried in a Soviet moon rocket to be launched "in the near future," according to Soviet sources. Work is being carried on "energetically" on the project, which has two payloads under consideration. One payload would impact. The other would orbit the moon and return to earth.

According to Dr. Vitaliy Bronshten, a Soviet scientist, the payload will be equipped with instruments for determining the moon's mass and conductivity of heat and electricity; with apparatus for investigating the moon's surface and discovering possible landing places for manned space vehicles; with equipment for investigating the moon's magnetic field; and with television apparatus for viewing the dark side of the moon.

## Marquardt Plans To Buy Cooper Development Corp.

Marquardt Aircraft Co. has completed negotiations to acquire the Cooper Development Corp. in exchange for 60,000 shares of Marquardt stock and, effective November 20, will operate it as a wholly-owned subsidiary.

President Roy Marquardt said the acquisition is in line with Marquardt's policy of giving continued consideration to a program of diversifications in the field of advanced research and developments relating to flight in the



# DUCTING AND COMPONENTS ENGINEERING BRIEFS



One of a series of reports to help you  
make more effective use of Flexon products.

## ENVELOPE PROBLEMS? VOLUME CONTROL PROBLEMS?

Solve them with Flexon Vari-Form Ducting Components

As the geometry of ducting becomes increasingly complex, forming problems are compounded. Maintaining equivalent volume becomes difficult through a variety of transitions in shape. These considerations added to the long standing problems of weight, strength, heat resistance, etc. make ducting system design a severe test of ingenuity in fabrication.

Flexonics Corporation's development and advancement of the Vari-Form Process is making the designer's job easier. The Vari-Form method produced from tube is more economical and superior to many half-shell types with burnt down welds.

Vari-Form ducting components are made by redeposition of material to all applicable MIL specs and in small or large quantities.

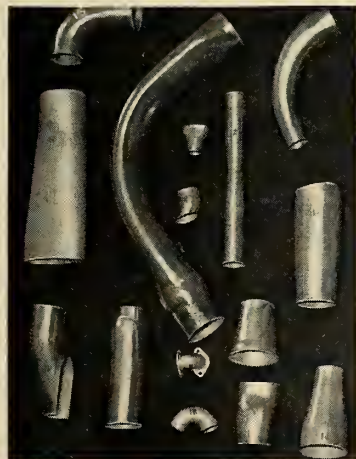

A representative group of shapes formed by the Vari-Form Process.

According to requirements, wall thicknesses ranging from .010 to .049 are made in daily production routine in such unusual shapes as 1:1 bends in stainless steel thin-wall tubing PLUS unusual shapes, transitions, elliptical, square—anything needed to meet the condition. All are high strength with ultimate yield of approximately 70,000 psi. Metals customarily used in M/R applications and aircraft are easily handled: CRES 302, 304, 316, 321,

missiles and rockets, November 17, 1958

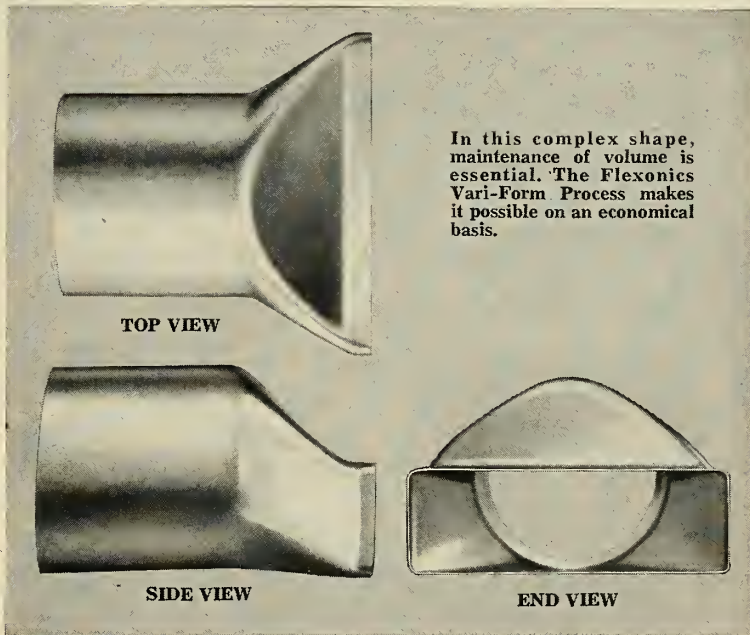

In this complex shape, maintenance of volume is essential. The Flexonics Vari-Form Process makes it possible on an economical basis.

347, Inconel X, 19-9DL, Monel and many others, including Titanium.

#### Advantages to the Designer

By specifying Flexon Vari-Form Ducting Components, the designer frees himself from the severe limitations of conventionally formed components. He is not troubled by limitations in configuration. He is assured of maintaining volume when it is required. He is able to hold weight to a minimum. He need not sacrifice strength for other considerations.

#### Advantages in Production

Flexon Vari-Form Ducting Components are made to very close tolerances, eliminating bad fit-up. Costs are held

in line because Vari-Form Components can be made in any quantity from 1 to many thousands with minimum tooling expense.

#### Engineering Assistance Available

If you have unusual ducting or piping problems, you can take advantage of Flexonics Corporation's experience. As the nation's most experienced manufacturer of metallic plumbing components for aircraft, rockets and missiles, Flexonics is qualified to help you in the most advanced design problems.

It will pay you to learn more about the Vari-Form Process and how it can serve you. For specific recommendations send an outline of your needs.

# Flexonics Corporation

AERONAUTICAL DIVISION  
A-39

1414 S. THIRD AVENUE • MAYWOOD, ILLINOIS

In Canada: Flexonics Corporation of Canada, Limited, Brampton, Ontario  
Also Manufacturers of Rubber and Metal Hase Assemblies • Metallic Bellows • Expansion Joints

Circle No. 16 on Subscriber Service Card.

atmosphere and in space. This is Marquardt's second acquisition in the last few years. Earlier it took over the Associated Missile Products Co. from American Machine & Foundry Co. and is now operating it as its Pomona division. The work being done by Cooper Development in high altitude exploration with sounding rockets and rocket components appears to have excellent growth potential, Marquardt said in a recent statement.

Cooper Development has plants at Monrovia, Baldwin Park and Rialto, Calif. It had sales of \$2.4 million in the fiscal year ended February 28 last, and anticipates \$3.5 million for the

current fiscal year. Clifford D. Cooper, president of the corporation, will continue in that capacity as principal executive officer of the Marquardt subsidiary. He also will become a vice president of Marquardt.

Since its inception in 1951, Cooper Development has been associated with research projects to measure atmospheric and meteorological conditions at extremely high altitudes. Among these are the rocket airframe and rocket motor case for the third stage of the Vanguard, the high speed stages of the Explorer, and the LOKI-Rockoon, first cosmic ray rocket fired to more than 400,000 feet altitude.

## White Lance

### Liquid Packaged Engine, Nuclear Head

The Air Force has an air-to-surface missile called the *White Lance* (m/r Oct. 6, p. 21), and while the early version is still the Navy's *Bullpup*, an advanced model will incorporate radically-new features.

The advanced *White Lance* reportedly will still resemble *Bullpup* in configuration. Guidance, engine and warhead will be different. *White Lance* will be manufactured by the Martin Company's Orlando Division. Air Force has awarded Martin a development contract with emphasis on guidance.

Several of its brand-new features should be TV guidance, a storable liquid-propellant engine, and a nuclear warhead. *White Lance* will be employed by the Tactical Air Command first, but many NATO-member nations are bargaining for the missile, which conceivably could be manufactured abroad under a licensing agreement.

Air Force has been in the *Bullpup* program for several years, but has not gone along with Navy thinking. Air Force, for example, wants the missile to be stored in aircraft wings, while Navy with its folding wing carrier aircraft, does not have this requirement.

*Bullpup's* command guidance radio link also has not been acceptable to the Air Force, which authorized Bell Aircraft to come up with a different type. Bell's proposal, however, did not meet with Air Force approval, and the service accepted the Martin developed CORAL (Correlated Radio Link).

But Air Force is still looking in the guidance direction for *White Lance*, and this time the area is TV. The Allegheny Ballistics Laboratory solid-grain motor may possibly be set aside by Air Force in favor of a storable-liquid-propellant engine. And most important, *White Lance* probably will have a nuclear warhead instead of *Bullpup's* present 250-pound bomb.

The TV guidance, an offshoot of work started during World War II and culminating with the *Tarzon* missile, is a comparatively recent development. The new system reportedly has overcome earlier complaints about instability and other TV troubles.

The guidance undoubtedly will extend the present visual range of *Bullpup* or *White Lance* to something around horizon limits. A stabilized scanner-transmitter will be mounted in the nose of the missile and a receiver will be pilot-monitored in the cockpit of the airplane. But even with TV guidance, the missile still will not have

## THE KEY TO SUCCESS IN THE PALM OF YOUR HAND!



Huck's continuing research and development program offers today's designing engineer the last word in fastening materials and methods, even anticipating problems not yet evident on the drawing board.

In Huck's complete line of fasteners you will find the better answer to your problem, whether it be strength in tension, shear or elevated temperature . . . high clinch . . . effective sealing . . . low clearance or blind applications . . . in all desirable standard or exotic metals.

Huck's reputation for accuracy, uniformity and dependability is your assurance of right-from-the-start performance.

We will gladly supply technical assistance and samples to meet your needs.

PULL-TOGETHER

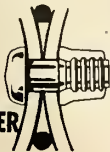

# HUCK

MANUFACTURING COMPANY

2480 Bellevue Ave. Detroit 7, Mich. Phone — WA 1-6207

Circle No. 40 on Subscriber Service Card.



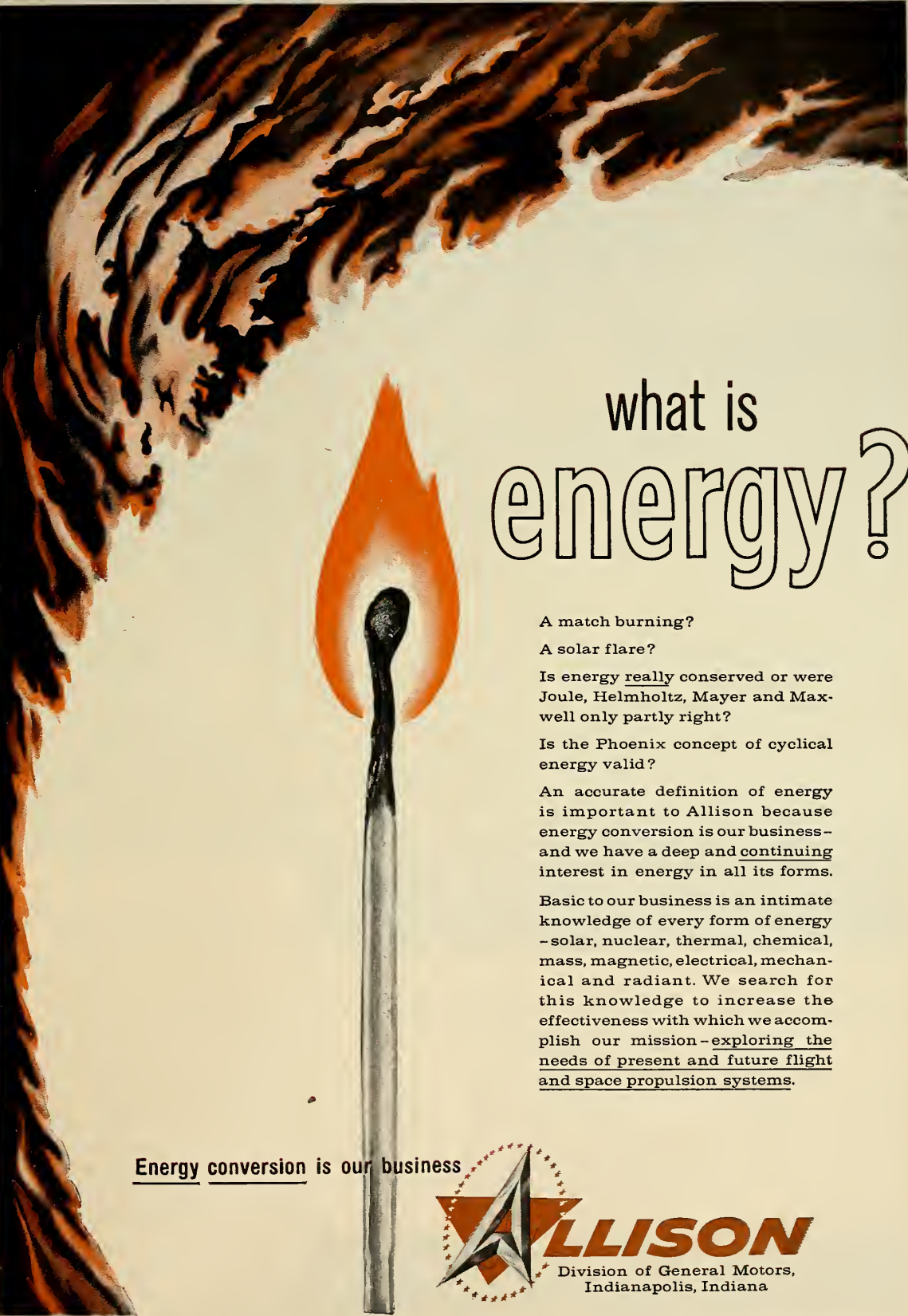

# what is energy?

A match burning?

A solar flare?

Is energy really conserved or were Joule, Helmholtz, Mayer and Maxwell only partly right?

Is the Phoenix concept of cyclical energy valid?

An accurate definition of energy is important to Allison because energy conversion is our business—and we have a deep and continuing interest in energy in all its forms.

Basic to our business is an intimate knowledge of every form of energy—solar, nuclear, thermal, chemical, mass, magnetic, electrical, mechanical and radiant. We search for this knowledge to increase the effectiveness with which we accomplish our mission—exploring the needs of present and future flight and space propulsion systems.

Energy conversion is our business



## This is White Lance

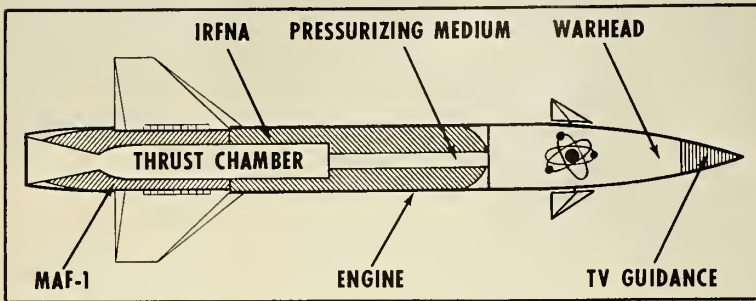

all-weather capability.

The liquid-propellant engine probably will be supplied by Reaction Motors Division of Thiokol Chemical. The engine, model LR 44-RM-2 (dubbed *Guardian* by Reaction in its *Sparrow III* application), will be supplied in fully-loaded condition, being fueled in the factory before shipment for assembly in the missile.

It uses inhibited red fuming nitric acid (IRFNA), and a Reaction Motors proprietary mixed amine fuel (MAF-1) for propellants. Operation of the engine is started by igniting a solid propellant gas generator which pressurizes the fuel tankage, and opens ports to the combustion chamber by forcing a shear slide forward. This simultaneous action allows the propellant to flow into the combustion chamber, where it is mixed by the solid propellant gases to insure proper burning.

To date, two models of the engine have been fired and another is slated to undergo test soon. All of this testing has been on the ground with flight tests still some time away.

Major advantage claimed by Reaction is that the packaged-liquid engine can be stored on the shelf for literally "years." Reaction sees many future uses for this type of engine in medium-sized missiles of the future, and even the possibility that large ballistic missiles in hard bases would use the new unit. *Bullpup's* present solid reportedly only has a useful limit—without replacement—of about six months.

Unfortunately, with all its sophistication, Reaction's new engine cannot properly be called a "breakthrough." The Germans, many years ago, had a missile called the *Taifun* (Typhoon), which had a packaged liquid. The missile was boosted to flight velocity by a solid booster and the accelerations imposed during the solid phase of its flight opened valves which started fuel flow and engine combustion.

The packaged-liquid concept puts new life into the liquid-solid battle which many have already conceded to the solids. Storable liquid engines, with their reasonable accelerations, might very well be the answer to shock and

acceleration problems which have become a plague to designers.

Cost of *White Lance*? Martin officials or the Air Force can not say, but one *Bullpup* costs about \$25,000 a copy in the prototype stage (not counting R&D money) and the missile is running about \$6,000 per bird in production. "Sophisticated" *White Lance* undoubtedly will run higher.

## French to Test Two More Research Missiles

First tests of the new French research missiles, *Veronique* and *Monique*, are expected to be held early next spring at the North African proving ground near Colomb Dechar.

The *Veronique*, according to Pierre Blassel of the French Directorate of Communications, is 24 feet long, 2 feet in diameter and carries a payload of 140 pounds to altitudes of 250 miles. The *Monique*, a smaller vehicle, carries a 30-pound payload. Both rockets were developed by the French Army, but are now being used by a civilian agency.

Blassel acted as spokesman for a visiting delegation of French military personnel making a tour of U.S. Air Force Bases in this country. The only private corporation visited was Cubic Corp., a San Diego firm engaged in electronics.

The North African missile test center has been in operation for about 10 years, with primary interest being centered around surface-to-surface and surface-to-air missiles. Blassel mentioned the *SS-10* and a missile comparable to the *Nike-Ajax* as examples of recent test activities.

## British Say Firestreak Superior to Sidewinder

British and Australian military spokesmen have indicated misgivings about the performance of the *Sidewinder* AAM.

British authorities have commented that the *Firestreak* is superior and claimed it is a "much more advanced and powerful weapon." The Australians, meanwhile, criticized what they termed the narrow sector in which the *Sidewinder's* guidance operates.

The missile could conceivably head into the sun, they said, and claimed that jet aircraft could easily evade it. "All an enemy pilot has to do is fire a flare and the *Sidewinder* takes off after the flare," they said.

*Sidewinder*, however, has been an effective weapon in the current Quemoy crisis.

DESIGN-ENGINEER & PRODUCTION OF AIRBORNE & GROUND SUPPORT EQUIPMENT

# CRITICAL ACCURACY

with BULOW  
HEATER  
THERMOSTATS

HEATER-THERMOSTAT ASSEMBLIES FOR ACCURATE TEMPERATURE CONTROL OF FLUIDS FOR THE REDSTONE AND JUPITER. DIRECT ALL INQUIRIES TO COMPONENTS DEPARTMENT.

MISSILE TRAINING EQUIPMENT • GROUND SUPPORT TEST EQUIPMENT • COMPONENTS-PRESET TIMERS, TIME INTERVAL METERS, ANTENNAS, HEATER THERMOSTATS, TAPE READERS

**BULOW ELECTRIC CO.** 11000 CAPITAL, OAK PARK 37, MICH.

Circle No. 39 on Subscriber Service Card.



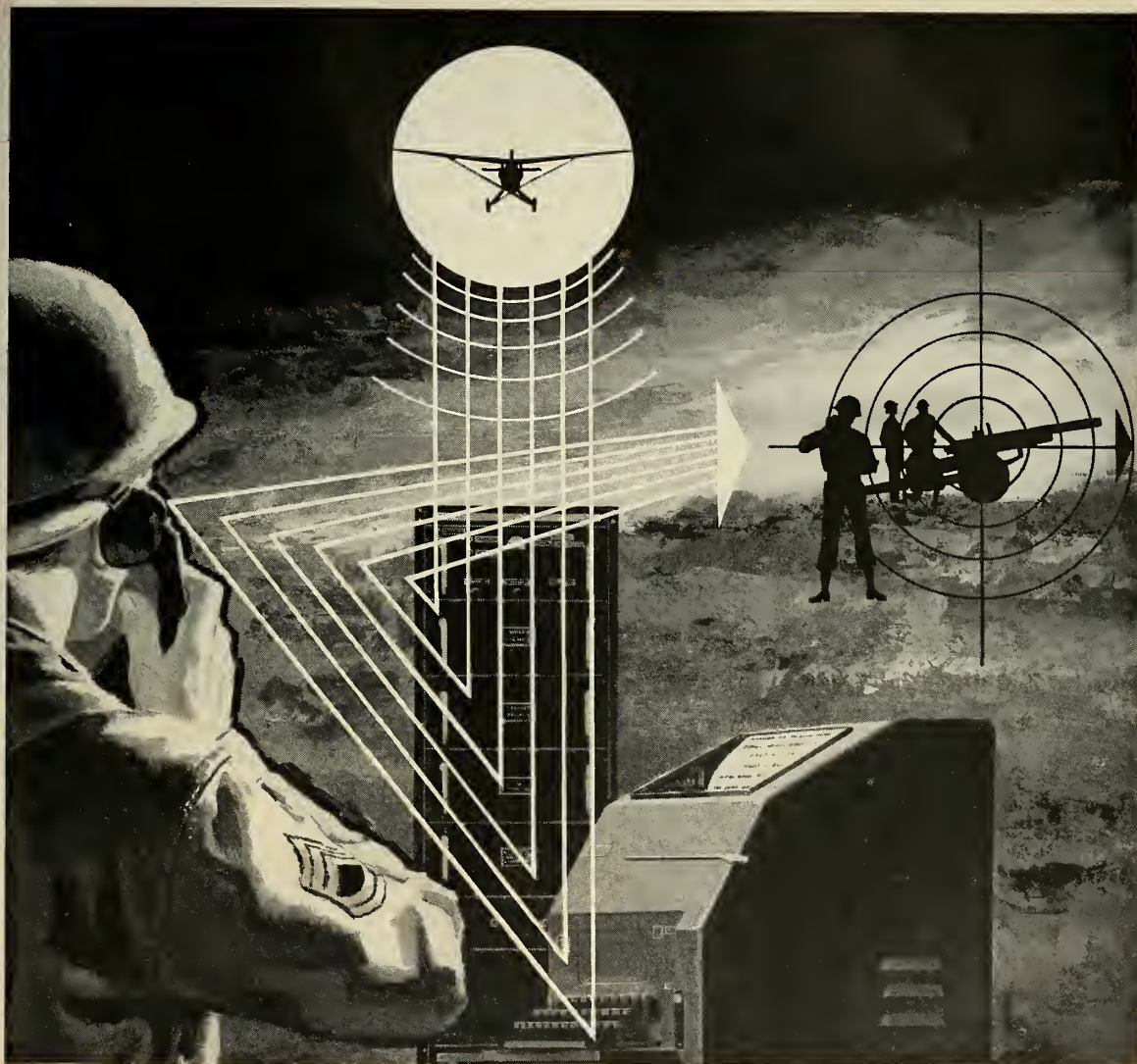

Why **LABIL** is a powerful link in the communications chain

Speed and reliability make LABIL, Stromberg-Carlson's new data link, ideal for automatic transmission of flight information from light aircraft to ground receiving and control locations.

Into the link the pilot or observer can enter 13 types of data regarding flight and target. When the ground control group wants the information, a lamp on the panel of the airborne equipment lights. The pilot or observer presses the transmit key, and the entire stored message is automatically transmitted over his *existing voice communications equipment*.

Greatly increased reliability is achieved by transmitting each character *twice*.

At the receiving end the message is checked for errors

due to noise interference. The error detector examines the two transmissions for complete agreement, then prints the message out on a teletypewriter. Speed of transmission is limited only by the bandwidth of the communications equipment and printout device.

The standard format and digital nature of each transmission make LABIL easily adaptable to large-scale operational control systems in which automatic data handling is a requirement.

Complete technical data on Stromberg-Carlson's Light Aircraft Binary Information Link is available on request.

*"There is nothing finer than a Stromberg-Carlson"*

**STROMBERG-CARLSON**

A DIVISION OF GENERAL DYNAMICS CORPORATION  
1463 N. GOODMAN ST. • ROCHESTER 3, N. Y.  
Electronic and communication products for home, industry and defense





**FIT  
TO  
FLY**

**AMP**

*THE NEW  
LIGHTWEIGHT  
A-MP "240"  
PATCHCORD  
PROGRAMMING  
SYSTEM*

... means lightning fast in-flight reprogramming of airborne electrical/electronic circuitry... obsoletes fixed circuit connectors and other systems requiring hours or days to rewire... and offers these unusual features:

- removable patchboards to permit complete reprogramming in seconds
- 3 ¼ pounds to minimize weight... miniaturized to conserve space
- rugged shock and vibration-resistant construction with high strength aluminum alloy
- shock-resistant seating of patchcord plugs in removable board
- AMP's patented wiping action that pre-cleans contacts for top electrical performance
- 240 contacts for greatest versatility in circuit combinations or program arrangements

*For more information on this new airborne wiring technique, AMP's Patchcord System Catalog is available on request.*

**AMP INCORPORATED**

**GENERAL OFFICES: HARRISBURG, PENNSYLVANIA**

A-MP products and engineering assistance are available through wholly-owned subsidiaries in: Canada • England • France • Holland • Japan



\$3.7 billion was available for more procurement.

All agree that a sum running over a third of all missile expenditures—about \$2 billion—is being spent at the same time for research and development work—some of it going to the same prime and subcontractors, some to engineering firms, universities and individual consultants.

• **R&D a special subject**—The heavy emphasis on research and development activities also brings a special flavor into any attempt to estimate the size of the missile field—partially because it has brought a new factor into the general business picture.

In the past four months, for example, m/r has reported more than 800 contract awards varying in size from a few thousand dollars to several million. A good one third of these—for a substantial aggregate sum—are for research and development.

And the new factor is that most major U.S. universities have emerged as major contractors in this field. The use of university laboratory and other facilities to aid industry is not, of course, a new thing to American in-

dustry. Laboratories such as Lehigh University's Fritz Engineering Laboratory at Bethlehem, Pa., have long been employed by manufacturing companies to investigate phases of their work—such as the strength or heat-resistance of materials.

But roughly 92 technical universities have emerged as contractors in their own right in missile work, bidding for work against private research organizations. How to classify them as a part of an industrial field is a baffling problem.

Of course, the whole emphasis on R&D work for missiles is something new in itself. Many established industries maintain research sections or agencies—but no industry has ever been built on the fact that more than a third of its total strength is allocated initially and directly to research as a separate activity.

• **More concerned**—Beyond the industrial and consulting groups that can be directly identified with missiles are the several thousand organizations that figure in the field in some way.

For example, the Army's Corps of Engineers recently let sizable con-

struction contracts for missile bases, to firms whose business is construction—not missiles. Other businessmen are supplying fuels, services (including repairs), housing both for personnel and for the "birds" themselves. Feeding, medical care, transportation both local and national are a part of the picture too. For instance, trucking firms whose principal business has been the moving of household furniture have moved swiftly into the business of transporting missiles. Railroads have also eyed this phase of missile work—the New York Central, for instance, recently demonstrated a specially-built flatcar for transporting the big weapons.

Camera and film companies, manufacturers of nuts and bolts, machine tools, fasteners, wiring and plastics, suppliers of basic raw materials such as steel and other metals and ceramics, are also concerned.

By way of illustration, the Connecticut Development Commission recently published a survey of state industry, which showed that 224 firms in the state were (in mid-year) supplying parts and services for missiles.

Significantly, the survey found that another 272 firms considered they could also contribute to missiles—and were seeking means of getting into the business.

## NEW BENDIX MS-R ENVIRONMENT RESISTING ELECTRICAL CONNECTOR



Now available and approved in complete conformance with MIL-C-5015D.

This new connector answers the demand from the aircraft industry for a shorter, lighter and more reliable environment resisting connector. This connector will inactivate practically all other MS types and the Military has assigned a new class letter R to insure incorporation of this better connector in all new designs.

An important reliability feature of the new MS-R connector is an "O" ring at the main coupling joint which provides for the best possible sealing and more positive inter-facial compression and assures complete performance compatibility among all approved MS-R connectors. Establishment of the MS-R connector as the "universal" military connector is testimony to the record of previous MS environmental resistant connectors using resilient inserts as pioneered by this Division. In the Bendix\* connector, wire sealing is accomplished by an exclusive slippery rubber grommet which permits convenient wire threading and grommet travel over wire bundles.

Write for more complete information on this latest addition to the ever-growing family of Bendix electrical connectors.

\*TRADEMARK



SCINTILLA DIVISION  
SIDNEY, NEW YORK



Export Sales and Service: Bendix International Division, 205 East 42nd St., New York 17, N.Y.

Canadian Affiliate: Aviation Electric Ltd., 200 Laurentien Blvd., Montreal 9, Quebec.

FACTORY BRANCH OFFICES:

117 E. Providencia Ave., Burbank, Calif. • Paterson Building, 18038 Mack Ave., Detroit 24, Mich. • 545 Cedar Lane, Teaneck, N.J. • 5906 North Port Washington Rd., Milwaukee 17, Wis. • Hulman Building, 120 W. Second St., Dayton 2, Ohio • 2608 Inwood Road, Dallas 19, Texas • 8425 First Ave., South, Seattle 8, Washington • 1701 "K" Street, N.W., Washington 6, D.C.



## STRAIGHT TALK TO ENGINEERS

*from Donald W. Douglas, Jr.*

*President, Douglas Aircraft Company*

In this fast-moving age we find that we can no longer insure leadership...or even survival... by doing things the traditional way. If there's a better way, we must find it.

Our DC-8, C-133, Thor, Nike-Hercules, Genie, Sparrow and other aircraft and missiles are all the finest of their type and time. But their success, and that of our many new projects, depends on superior engineering.

That's why I'm looking for engineers dedicated to quality work. Only through such dedication can the extra performance and reliability of our products be attained. If you feel as we do about this principle, we'd certainly like to hear from you in regard to a future at Douglas.

Write to Mr. C. C. LaVene,  
Douglas Aircraft Company, Box 620-R  
Santa Monica, California

missiles and rockets, November 17, 1958



## Bureau of Standards: Calibration Is Its Task

### Recently Opened Colorado Facility Establishes Electronics Standards Widely Used by Missile Industry and Government

by Raymond M. Nolan

In the October 27 issue of *m/r*, a description of the four primary standards of measurement was given. These were: time, the meter, the kilogram and the degree. While all of these are basic to measurement of physical phenomena, the precise measurement of units peculiar to the electronics field are more in the forefront today. Recognizing this, the National Bureau of Standards recently established an Electronics Calibration Center at Boulder, Colo. Housed in a new wing of the Radio Standards Laboratory, the Center provides government, industry and the military services with access to the nation's primary electronic standards.

Here are calibrated the master working standards which in turn are used to adjust the instruments on production lines and in research laboratories—activities vital to the progress of future electronics programs in communications and space technology.

The primary mission of the NBS Electronic Calibration Center is to calibrate interlaboratory standards for such quantities as voltage, power, and

impedance in terms of the national standards maintained by NBS. These interlaboratory standards, in turn, are used to assure the accuracy of reference and working standards in laboratories, on the production line, and in overhaul stations throughout the nation.

The fundamental system of electrical measurement now employed in the United States uses absolute units, this is, units derived from the fundamental units of length, mass and time—the meter, kilogram and second. Basic to the absolute system of electrical units are the absolute ohm and the absolute ampere. The absolute ohm is derived from the absolute henry, based on an inductor of accurately known dimensions. The absolute ampere is established in terms of the magnetic force of an accurately dimensioned current-carrying coil measured with a current balance. These basic standards are maintained in the Bureau's laboratories in Washington. Other units, such as the watt and the kilowatt hour, are obtained by combining these units and by extending the scale of measurement. The units are then transferred to higher frequencies by

appropriate techniques.

The new center is offering services in three broad frequency ranges: low frequency (through 30 KC), high frequency (30 KC through 300 MC), and microwave (above 300 MC). The center recognizes that these will be future needs beyond what they are doing now, but plans to measure and standardize in the center all electronic quantities for which these is a substantial calibration need. Calibrations required only infrequently will still be obtained elsewhere within NBS.

In the low frequency region, the center provides calibrations for such electrical standards as resistors, bridges, potentiometers, inductors, capacitors, standard cells, electrical instruments, ratio devices and instrument transformers. Even though these devices are available at the center, the standards previously available at NBS in Washington will continue to be in force, in some cases with wider ranges than the new center can provide. In either case, the standards available will be in terms of the national primary standards.

• Resistance standards—NBS in

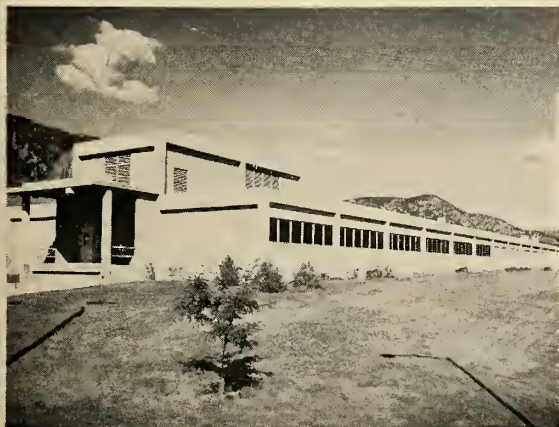

NEW HOME of the Bureau of Standards Electronic Calibration Center established at Boulder, Colo.



TYPICAL OF microwave equipment at the center is this X-band attenuator calibration device.



Missiles on the move need

## maximum mobility!

Multiple-wheeled rubber-tired vehicles, whether 6 x 6's or 8 x 8's, are built to provide maximum mobility under all conditions. Versatile and dependable... capable of fast highway speeds, as well as high maneuverability over rugged terrain... they offer the advantages of all-wheel traction, low floatation pressures, proven cargo stability, and greater load capacity in relation to vehicle weight.

Most of these vehicles can be made of standard driving components, and parts for these components are now available through the world-wide military supply system. They can be assembled in any combination to make driving units for

four-, six-, or eight-wheel vehicles.

For nearly 50 years, Timken-Detroit® Axles and Transfer Cases have been a major component for military vehicles. Now, with the addition of Hydra-Drives® Torque Converters and Power Shift Transmissions, Rockwell-Standard can supply complete power transmission assemblies—everything between the engine and wheels.

If you are a designer or builder of military vehicles, Rockwell-Standard engineering experience and manufacturing facilities are at your disposal. Our engineers will give prompt attention to any problem you have in power transmission.

Plants at: Detroit, Michigan  
Oshkosh, Wisconsin • Kenton and Newark, Ohio  
New Castle, Pennsylvania



WORLD'S LARGEST MANUFACTURER OF  
AXLES FOR TRUCKS, BUSES AND TRAILERS

Products of **ROCKWELL-STANDARD** Corporation



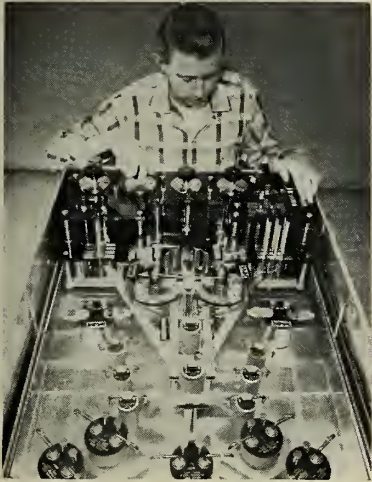

**DECADE CAPACITOR** is calibrated at audio frequencies using a capacitor bridge.

Washington maintains the unit of resistance by means of 10 extremely accurate, sealed, double-wall one-ohm standard resistors. This group also forms the basis of measurements made in the center. A Wenner bridge, including a thermostatically regulated oil bath for maintaining a constant known temperature, is used for calibrating standard resistors. A direct-reading ratio set is used to compare resistors with known standards by either a Kelvin double bridge or a Wheatstone bridge. Resistance comparisons, using a Wenner bridge, can be made to one part in 10 million under optimum conditions.

The components of bridges and resistance boxes are calibrated with known standard resistors by use of a direct-reading ratio set. Potentiometers are calibrated with a universal ratio set.

• **Inductance Standards**—Stable standards of self-inductance are used as components of a-c bridges and other circuits used in impedance measurements. An equal substitution method using a Maxwell-Wien bridge is now employed in the center. Three groups of calibrated inductors, capable of intercompared frequently to detect relative drifts of changes, serve as standards. One of these groups is calibrated periodically against the national standards of capacitance and resistance. Future plans are to construct a bridge which will measure even wider ranges of inductances and to check the stability of standards.

• **Capacitance Standards**—Equipment used in the center for calibrating capacitors consists of a capacitance

⊞ **SUBMINIATURE 13-DIGIT ENCODER** for airborne or other limited space applications. Detailed specifications in Bulletin 0858. **SIZE:** 2 $\frac{3}{16}$ " dia. x 3 $\frac{3}{4}$ " long;  $\frac{1}{4}$ " dia. shaft,  $\frac{1}{8}$ " long. **WEIGHT:** 1 $\frac{1}{4}$  lbs. **OVERALL ACCURACY:**  $\pm 1\frac{1}{4}$  quanta in 8192. **READOUT RATE:** Model A, nominally 10KC (50 microsecond pulse), max. of 100KC (5 microsecond pulse). Model B, max. of 200KC for element, 10KC for sequence. **MAXIMUM ANGULAR SPEED OF ROTATION AT FULL ACCURACY:** 2 rpm (6 rpm at 12-digit accuracy). 10 rpm with temperature control.

⊞ **4" DIA. 13-DIGIT ENCODER** for general purpose applications. Detailed specifications in Bulletin 0958. **SIZE:** 4" OD with protrusions on one side x 7" long;  $\frac{1}{4}$ " dia. shaft, 0.67" long. **WEIGHT:** 9 $\frac{1}{4}$  lbs. **OVERALL ACCURACY:**  $\pm 1$  quanta in 8192. **READOUT RATE:** 100 cps, max. **MAXIMUM ANGULAR SPEED OF ROTATION AT FULL ACCURACY:** 720 rpm; maximum rotation rate, 600 rpm.

⊞ **6" DIA. 13-DIGIT ENCODER** for general purpose applications. Specifications in Bulletin 1058. **SIZE:** 6 $\frac{3}{16}$ " dia. with protrusions x 7 $\frac{3}{4}$ " long;  $\frac{1}{2}$ " dia. shaft, 1" long. **WEIGHT:** 14 lbs. **OVERALL ACCURACY:**  $\pm 1$  quanta in 8192. **READOUT RATE:** 100 cps, max. **MAXIMUM ANGULAR SPEED OF ROTATION AT FULL ACCURACY:** 720 rpm (10 microsecond pulse).



Model A2.6SS13 (Parallel readout)  
Model B2.6SS13 (Sequential readout)



Model A4DP13



Model A6DP13

Now from

# Baldwin®

precision shaft angle analog-to-digital encoders in 5 standard models:

13, 16 and 18 digit /  
photoelectric readout / reflected binary code\*.

⊞ **9" DIA. 16-DIGIT ENCODER** precision unit for radar applications. Detailed specifications in Bulletin 1158. **SIZE:** 9 $\frac{1}{16}$ " dia. with protrusions x 4 $\frac{3}{8}$ " high;  $\frac{1}{2}$ " dia. shaft, 1 $\frac{1}{4}$ " long. **WEIGHT:** 17 $\frac{1}{2}$  lbs. **OVERALL ACCURACY:**  $\pm 1$  quanta in 65,536. **READOUT RATE:** 100 cps, max. **MAXIMUM ANGULAR SPEED OF ROTATION AT FULL ACCURACY:** 90 rpm (10 microsecond pulse).



Model A9SP16

⊞ **HIGH PRECISION 18-DIGIT ENCODER** for radar or theodolite applications. Detailed specifications in Bulletin 1258. **SIZE:** 21" max. dia. x 8 $\frac{1}{16}$ " high. **WEIGHT:** 169 lbs. **OVERALL ACCURACY:**  $\pm 1$  quanta in 262,144. **READOUT RATE:** 100 cps, max. **MAXIMUM ANGULAR SPEED OF ROTATION AT FULL ACCURACY:** 25 rpm (10 microsecond pulse).

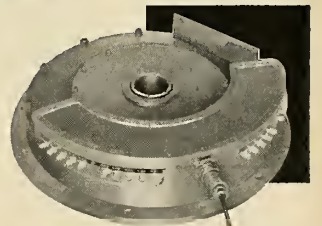

Model A21SP18

\*Encoders with decimal, trigonometric functions and other nonlinear codes are also available. All disks are made on a special divided circle machine designed and built by Baldwin. Write for descriptive bulletins.

Industrial Products Division  
**THE BALDWIN PIANO COMPANY**  
1802 Gilbert Avenue, Cincinnati 2, Ohio

# do you have these missile power problems?

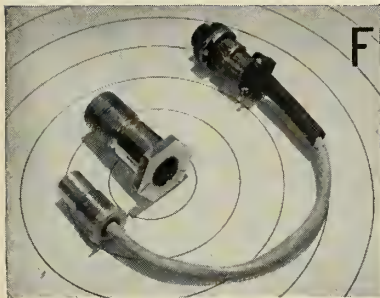

## FRACTURING ?

Frangible bolts from the Beckman & Whitley line combine the optimum in dependability and convenience for separating structures by electrical signal. Made to specifications, these bolts are internally threaded to receive the pre-wired charge which then attaches by standard connector to the missile circuitry provided. We'd like to help with your needs.

## DISCONNECTING ?

Double certainty of positive electrical disconnecting is provided by the selectively fired, two-charge design of this example from the line of Beckman & Whitley electrical disconnects. Shown assembled at right, this device can be provided with alternative primers as shown in the center. Shear pins hold the unaltered electrical connector assembly rigidly together until either or both primers are fired. Ideal for umbilical connections or other applications where guillotine choppers are not applicable. Perhaps these would help on your project.

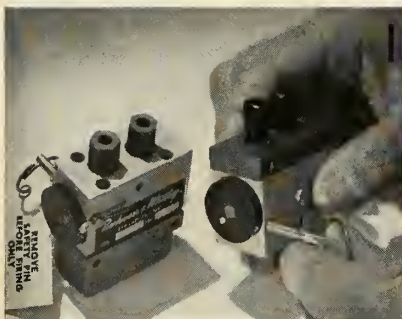

## INITIATION ?

Same basic mechanism serves, right, as a detonator-safe primacord initiator, having a lanyard-operated safety pin; or, by the substitution of an explosive charge, bottom left, unit becomes a destructor. Two separate channels for top reliability, mechanism so designed that re-insertion of safety pin reverses unit from "arm" to "safe" position. If these sound too simple, we can show you some complicated ones.

Pre-packaged explosive power units provide higher reliability and greater power for a given weight and volume of space than any other actuation method. Some of the many other applications to valving, ejecting, fracturing, etc. may be interesting to you. Just ask us.

**Beckman & Whitley INC.,**

San Carlos 16  
California

... missile electronics



WENNER BRIDGE is used for calibrating these accurate, sealed double-wall 1-ohm standard resistors.

bridge having internal capacitance standards which are, in turn, calibrated by step-up procedures using standard capacitors. Three groups of standard capacitors, with one group calibrated in terms of the national standard of capacitance, are used for intercomparison to detect relative drifts or changes.

Fixed capacitors, with air dielectric for low values of capacitance and micro dielectric for higher values, are used as components of a-c bridges as standards for the external calibration of bridges and for the calibration of other standards by substitution.

▪ **Standard Cells**—The center calibrated both types of Weston cadmium standard cells: saturated cells, used principally for reference standards of electromotive force, and unsaturated cells, used mainly as working standards of electromotive force.

The cells are compared directly with saturated standard cells with a microvolt potentiometer and the standard cells are compared periodically with the group of saturated cells which the Bureau uses to maintain the unit of electromotive force.

The emf of standard saturated cells is presently measured to a precision of about two microvolts with an accuracy of 0.001 per cent. However, a temperature-controlled oil bath, scheduled for completion at the end of the year is expected to give even greater accuracy.

Unsaturated standard cells have rather low temperature coefficients of about five microvolts/degrees O. Con-





LECTROFILM\* -B CAPACITORS

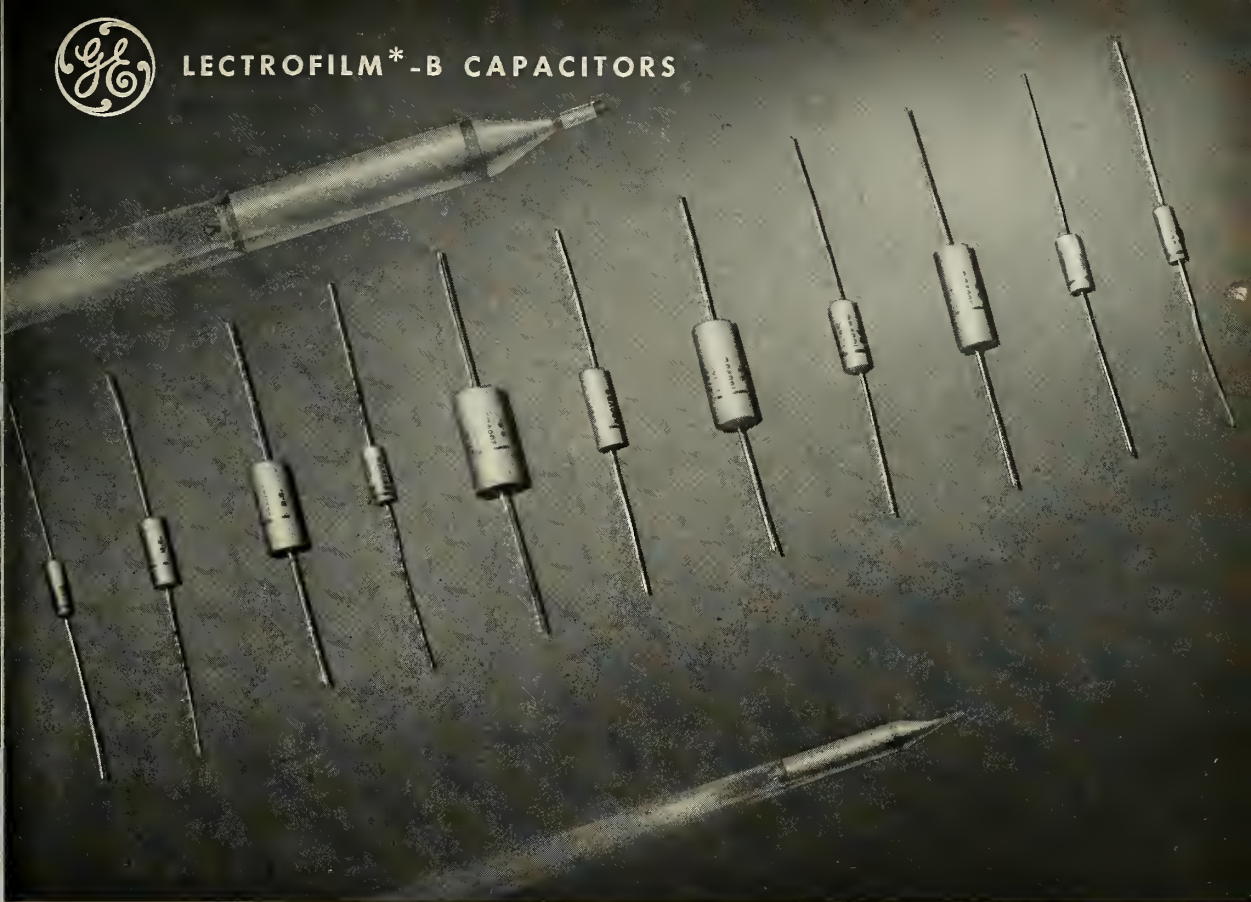

General Electric Announces for Missile Use . . .

## New Lectrofilm\*-B Capacitors for 44,000 Hours of Reliable Life

New G-E Lectrofilm-B capacitors offer you maximum reliability at lowest possible cost . . . results of over 3,000,000 unit-hours of life test data (per G-E Spec. MTC-3) indicate a probability of survival in excess of 0.99 for 44,000 hour life under rated voltage at 85C. Under rated voltage at 125C, the indicated probability of survival is in excess of 0.98 for 44,000 hour life.

**LOW FAILURE RATE AND LONG LIFE** of these inexpensive G-E capacitors result from using only the highest quality materials and the closest of process controls . . . units are tightly wound with high-purity aluminum foil and capacitor-grade Mylar† film dielectric. No solder is used, and introduction of contaminants through impregnation is eliminated.

**SMALL, LIGHTWEIGHT ENCLOSURE** consists of tape wrapped around the compact roll and sealed with epoxy resin, forming a rugged case which resists humidity, vibration and shock.

**TO MEET YOUR APPLICATION REQUIREMENTS**, 14 case sizes are available in five ratings—100-, 200-, 300-, 400-, and 600-volts. Capacitance range within each rating is: 0.015 to 0.68 uf in 100 volts; 0.010 to 0.47 uf in 200 volts; 0.0047 to 0.22 uf in 300 volts; 0.0033 to 0.15 uf in 400 volts; and 0.0010 to 0.10 uf in 600 volts.

**GET A QUOTATION TODAY ON NEW LECTROFILM-B CAPACITORS** by contacting your General Electric representative. Ask for your copy of life-test data and G-E Specification MTC-3. Or, write to Section 447-4, General Electric Co., Schenectady, N. Y.

\*Trade-mark of General Electric Co.

†Reg. trade-mark of DuPont Co.

*Progress Is Our Most Important Product*

**GENERAL  ELECTRIC**



## POURED-IN-PLACE FOAM and THE CRAIG HELICOP-HUT\*

The term Helicop-Hut\* is a copyrighted trademark name that stands for the original of the design of a Craig shelter using a combination of poured-in-place foaming processes, high tensile aluminum sheet and extrusions, and Epoxy Resins to achieve the optimum of insulation "K" factor, ruggedness and lightness in weight. This type of foam construction is non-hygroscopic, non-nutrient to fungus, and capable of withstanding severe thermal shock. A two-inch thick aluminum-faced panel has an insulation "K" factor of 0.115.

Developed and perfected by Craig engineers over the past four years, these foaming processes and fabrication techniques, together with the details of structural design, are now being incorporated into an increasing number of shelters built to military specifications, including S-97, S-98, S-118, S-138, S-141, S-144, S-152 and S-155.

You get this kind of built-in reliability only from Craig. And you find it in *all* Craig shelters and vans, from tactical communication and navigation centers to missile firing, sighting, and checkout stations.

Also worth remembering: Craig production schedules are geared for early delivery — prototype or production. For complete information, write or phone:

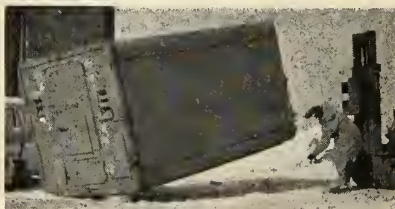

Strength and ruggedness of foamed-in-place plastic and aluminum construction is illustrated by this rotational end drop test of Craig Model 129 Helicop-Hut\* with 6,000 pound payload.

\*TRADEMARK & COPYRIGHT

# Craig SYSTEMS, INC.

360 Merrimack Street, Lawrence, Massachusetts  
Dept. B-1 Tel.: MUrdock 8-6961

Los Angeles 45, California  
621 W. Manchester Ave.—SPring 6-0025  
Haddonfield, New Jersey  
1016 Berlin Road—HAzel 8-2400  
Washington, D. C.  
The La Salle, Suite 815,  
1028 Conn. Ave., N.W., District 7-1575

sequently, temperature control is not nearly as important as for saturated cells. Results of calibration are usually given to 10 microvolts and the cells are certified to 0.01 per cent.

• **Electrical Instruments**—Indicating instruments, whether they are used for direct reading or for calibrating other instruments, are essential to the measurement of electrical quantities. The center can calibrate instruments in the 0.5 percent accuracy class or better.

The basic standards for d-c calibration of electrical instruments are standard cells and resistors, and the standard measuring apparatus is a potentiometer. Corrections for the standards are known and applied to obtain measurements of high accuracy.

• **Transformers**—The center calibrates (at 60 cps) transformers having 5-ampere secondary windings and primary current ranges of 0.1 to 4000 amperes, and voltage transformers with 110 to 120-volt secondaries and primary-to-secondary voltage ratios of one to 120. Plans are in the works to do this same work at 400 cps.

• **High Frequency**—In the high-frequency region (30 kc to 300 Mc) the Electronic Calibration Center is being equipped initially to calibrate standards of voltage (unbalanced), power, impedance, attenuation, and field strength. These standards are limited at present to those designed for continuous-wave measurements.

For each of the quantities to be measured, stable cw sources of high-frequency power and stable detectors or indicators are required. To achieve the desired frequency stability of the calibration system, crystal-controlled power sources and receivers are used wherever possible. In addition to good frequency stability and waveform, the sources must have very nearly constant power output. Power-stabilization circuitry has been developed that will hold constant the power output to better than 0.1% over long periods of time. Crystal-controlled superheterodyne receivers serve as monitors of detectors to give comparable frequency stability and to provide the necessary sensitivity. Most of the high-frequency instrumentation has been assembled in console form.

For most quantities, calibration services are planned primarily for the nine fixed frequencies of 30, 100, and 300 kc, and 1, 3, 10, 30, 100, and 300 Mc. Other frequencies will be available for some quantities. In addition,



# CONVAIR-Astronautics...expanding man's knowledge of the universe

In building, flight-testing and further developing the Atlas ICBM for the U.S. Air Force, **CONVAIR-Astronautics** also gains knowledge and experience useful for our operations in space. This intelligence, vital to the United States for future defense and peaceful pursuits, can be greatly expanded through advanced Orbital Systems developed by **CONVAIR-Astronautics** from its experience with the Atlas.

**CONVAIR** A DIVISION OF GENERAL DYNAMICS CORPORATION





# "BERYLLIUM"... IS OUR MIDDLE NAME



Experience is the best teacher and we have our Masters Degree in **PRECISION MACHINING** and **FABRICATION** of this atomic age wonder metal, **BERYLLIUM**.

You can expect the finest end product results when you deal with The American Beryllium Company. The heavy demand for our country's greatly accelerated missile and nuclear development programs brings the "Wonder Metal" — **PURE BERYLLIUM** — into the limelight.

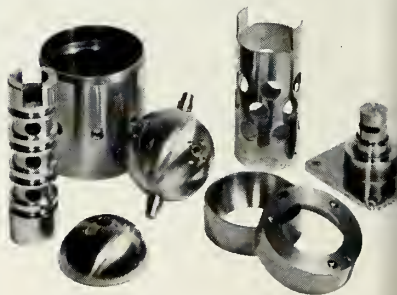

The incredible close tolerances made necessary by today's requirements by users of Beryllium, made the American Beryllium Company the leader in this field, because for the past two decades ultra-precision has been the experience of their personnel. We pride ourselves on past performances and would like to help you open the doorway to tomorrow. Remember—Beryllium is our middle name.

**SEND FOR OUR COLORFUL FREE BROCHURE** — Complete information in full detail is yours. Wire-write, or phone. If you use Beryllium, you can use our services.



*American Beryllium Company*

A DIVISION OF VISIONEERING COMPANY, INC.

SARASOTA BRADENTON AIRPORT, P.O. BOX 3142, SARASOTA, FLORIDA

OUR REPRESENTATIVE will gladly call on you at your request. Telephone ELgin 5-5105 for Big News for users of Beryllium.

Circle No. 60 on Subscriber Service Card.



## ... missile electronics

tion to the fixed frequency apparatus, continuous frequency coverage is provided wherever feasible. However, this equipment will be less stable and less accurate.

• **High-Frequency Voltage**—The instrumentation for high-frequency voltage calibration consists of stable transfer standards which operate over the desired range of voltages and frequencies. The range of voltage to be covered by presently planned equipment is from 1 microvolt to several hundred volts, and the frequency range is from 30 kc to 700 Mc (later to 1000 Mc) at 13 fixed frequencies. The top limit of the voltage range will be lower at the higher frequencies.

Voltage levels of 0.2 V and higher are covered by the voltmeter calibration consoles. The transfer standards used in these consoles are attenuator-thermoelement (AT) voltmeters. The attenuators are of the dissipative, capacitive, or waveguide-below-cutoff type. Dissipative attenuators are used at voltage levels up to 20 V. Above this level the power requirement are so great that this type of attenuator is not practical. For higher voltage levels, capacitive attenuators are used at the lower frequencies and waveguide-below-cutoff attenuators at the higher frequencies. The AT voltmeters have been provided with a mount which permit a very short lead length between the standard and the meter under calibration. This mount is so constructed that any type of voltmeter can be connected by means of a simple adapter.

Employed in the voltmeter calibration consoles are fully shielded, stable crystal-controlled sources. The consoles contain protective circuits that prevent overloading and consequent change in calibration of the standard volt-meters. These meters are calibrated in terms of the national standard of high-frequency voltage and provide a calibration accuracy of approximately 3 percent.

Voltages from one microvolt to 0.1 V will be covered by the micro-volt calibration console. The transfer standard used in this console is the rf micropotentiometer, consisting of a coaxial rf resistor and a thermoelement. The thermoelement indicates the current through the resistor, and therefore the voltage across it. The resistors vary from one milliohm to one ohm to cover the voltage range. These resistors and thermoelements are so constructed that their response is essentially uniform over the required frequency range. Power from the rf sources in the voltmeter calibration

console will be used also for the micro-volt calibration console. A series of very sensitive fixed frequency receivers, adjusted to have an input impedance of 50 ohms, transfers the reference voltage level from the micropotentiometer to an instrument undergoing calibration. The expected accuracy of calibration for the lower frequencies is +5% for the range 1 to 10 micro-volt and +3% for the range 10 micro-volt to 0.2 V. The accuracy will decrease as the frequency increases.

• **High-Frequency Power**—Three instruments provide high-frequency

power calibration over a wide range of power levels: A thermistor bridge; a dry, static calorimeter; and a liquid-flow calorimeter. These three instruments offer a convenient means of establishing high-frequency power levels and for calibrating feed-through watt-meters.

The thermistor bridge is an equal-arm Wheatstone bridge with a thermistor in one arm. Power levels up to 100 mw can be measured over the frequency range 30 kc to 300 Mc with an accuracy of 0.5 percent. This accuracy limitation is due to substitution error and mount efficiency considerations



**QUALIFIED!**

**QUALIFICATION TEST REPORT BY AEROTEST LABS: VITAL STEP TOWARD RELIABILITY AND ACCEPTANCE**

In today's highly technical and competitive aeronautical equipment business, a certified qualification test report from Aerotest Laboratories serves many important purposes. It proves that your product meets all specification requirements. It is evidence that your designers have achieved built-in reliability. And it adds a mighty big gun to your sales ammunition, because all leading contractors and Government agencies recognize Aerotest as a leading independent source for reliable, impartial testing of aircraft, missile and spacecraft equipment. Aerotest is an approved prime contractor to the U.S. Navy and Air Force. Complete, modern facilities and creative test engineering for all functional and environmental tests on electronic, mechanical, pneumatic, hydraulic and avionic equipment.

LOW TEMPERATURE	HUMIDITY	RAIN	ACCELERATED CORROSION
HIGH TEMPERATURE	SALT SPRAY	SUNSHINE	RADIO INTERFERENCE
HOT FUEL FLOW	IMMERSION	ENDURANCE	CONTAMINATED FUEL
HIGH ALTITUDE	SHOCK	EXPLOSION	FUEL RESISTANCE
SAND AND DUST	ACCELERATION	FUNGUS	ENVIRONMENTAL VIBRATION

Plus — High pressure flow testing of equipment with rocket and missile fuels and oxidizers.

Complete test program proposals submitted without obligation.  
Aerotest Laboratories, Inc. 129-11 18th Avenue, College Point 56, N. Y.

For the full story on Aerotest's facilities and services, send for free illustrated brochure.



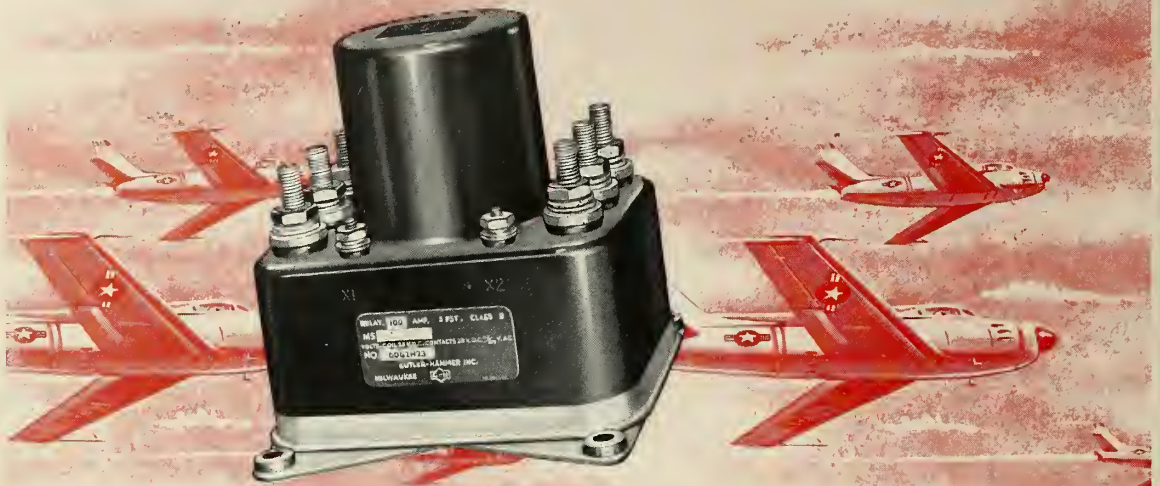

## Setting the pace for the Jet Age

Cutler-Hammer Hermetically Sealed Relays not only were designed to meet the high standards of Mil-R-6106; but also repeated tests prove they exceed many of the requirements with a wide margin of safety. Their performance under the most adverse test conditions has resulted in their adoption as the standard for "special use" by leading aircraft builders. And this family of Cutler-Hammer Hermetically Sealed Relays is not a mere dream for tomorrow; it has been in mass production for more than four years!

Cutler-Hammer Hermetically Sealed Relays, designed for either 28 volts D-c or 115/200 volts A-c, are available in a wide range of types and capacities.

Be sure you have the latest data. Write now on your company letterhead for Pub. EE140-W224. Cutler-Hammer Inc., Milwaukee 1, Wisconsin.

### Cutler-Hammer Power Relays Finest in Flight

Cutler-Hammer Hermetically Sealed Relays are designed to meet Spec. Mil-R-6106. Operate at 80,000 feet. Class A can operate in ambient temperatures to 71°C; Class B in ambient temperatures to 120°. Class B are available with or without auxiliary contacts.



50 amp. single pole, single throw Class A power relay.

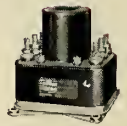

100 amp. three pole, single throw Class B power relay.



200 amp. single pole, single throw Class B power relay with N.O. and N.C. auxiliary contacts.



25 amp. three pole, single throw Class B power relay with N.O. and N.C. auxiliary contacts.



50/25 amp. single pole, double throw Class B power relay.



25 amp. three pole, double throw reversing duty Class B power relay.



# CUTLER-HAMMER

Cutler-Hammer Inc., Milwaukee, Wis. • Division: Airborne Instruments Laboratory. • Subsidiary: Cutler-Hammer International, C. A.

Associates: Canadian Cutler-Hammer, Ltd.; Cutler-Hammer Mexicana, S. A.; Intercontinental Electronics Corporation, Inc.



## ... missile electronics

rather than to the bridge instrumentation itself. The accuracy is reduced to about 5% as the minimum power level of 0.1 mw is approached.

With calibrated attenuators and directional couplers, the range of the bridge can be extended to 100 watts in the 100 to 3000 Mc region. However, under these conditions the overall accuracy of the apparatus in somewhat reduced.

The dry, static calorimeter consists of a special 50-ohm disk-type load resistor surrounded by a thick aluminum case. The load resistor has a very low temperature coefficient of resistance and provides a VSWR of less than 1.20 for frequencies below 300 Mc. It is heated by applying rf power, and its temperature is indicated by the emf from a 50-junction thermopile. The temperature of the aluminum case is kept constant to 0.002°C by a refrigeration unit and an electronically controlled heater cycling circuit. After equilibrium has been attained, the thermal emf is measured with a precision d-c potentiometer.

The thermal emf is calibrated in terms of applied dc power. Over the frequency range 0 to 300 Mc the overall accuracy is 1% for the power range of 20 mw to 12 w.

Nearing completion is a liquid flow calorimeter that is expected to be accurate to one percent over a range of 10 to 350 w at frequencies from 0 to 1000 Mc. It measures the temperature rise of oil flowing past a load resistor. This temperature rise is monitored with a 10-junction integrating thermopile. A precision d-c potentiometer measures the thermal emf, and a calibrated flow meter measures the oil flow rate. An absolute calibration also can be made by determining the specific heat of the oil and making an independent calibration of the thermopile emf as a function of temperature difference.

• **High-Frequency Impedance**—The standards of high-frequency resistance, inductance, and capacitance consist of stable components housed in shielded mounts. These standards are calibrated in terms of the national standard of high-frequency capacitance using susceptance variation techniques. The mounts have a special coaxial connector which mates with those on the impedance bridges used in the center.

This standardized connector was designed to provide a clearly defined reference plane and to minimize the effects of discontinuities in the connection, thus giving the standard an unusual value. Such a connector reduces the loss of accuracy in transferring the value of the standard to any

instrument with which it is to be used.

The values of the present set of standards range from 1 to 100,000 uuf for capacitance, 0.01 to 10,000 uh for inductance, and 1 to 100,000 ohms for resistance, with nominal values of 1, 2, or 5 times appropriate multiples of 10. These comprise a set of about 51 units, plus special mounts for combining units to obtain complex impedances.

The major portion of the impedance calibration services ultimately will be provided through the use of 18 bridges, each contained in a separate console and provided with its own individual exciter and detector. These

bridges, currently under construction, will consist of an impedance and an admittance bridge for each of nine fixed frequencies. The design goal is to provide a direct reading accuracy of 0.1 percent.

Four general-coverage bridges have been provided for interim use during the construction of the 18 fixed-frequency bridges and also for calibrations at frequencies other than those covered by the fixed-frequency instruments.

• **High Frequency Attenuation**—To meet present-day accuracy requirements for high-frequency attenuator

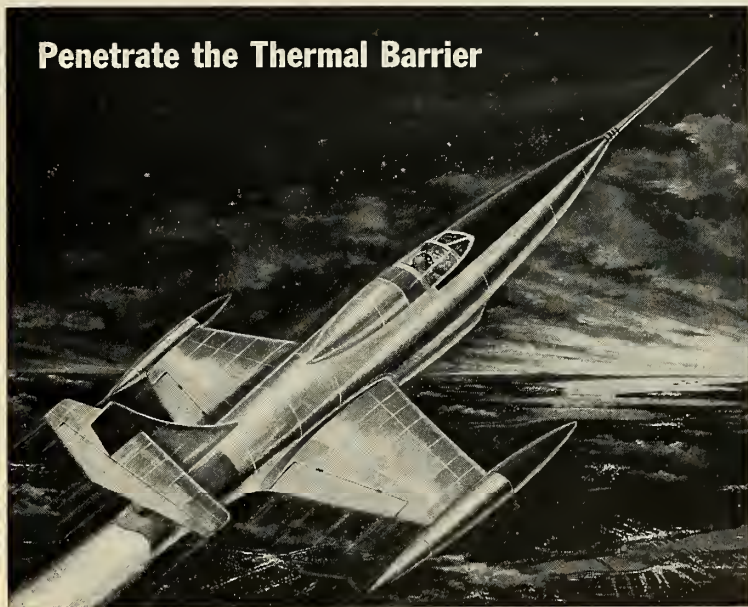

### Penetrate the Thermal Barrier

## MicroMach extra-high-tensile stainless steel sheets up to **48" WIDE** for aircraft and missile use

As the speed of today's aircraft rapidly approaches the Thermal Barrier, conventional metals are being left far behind in the race to satisfy the structural requirements of supersonic craft. Needed are metals that can withstand the intense heat caused by air friction at high speeds and still retain their strength. One such metal, MicroMach stainless, has been in use for more than a year.

MicroMach is a special aircraft and

missile grade of modified type 301 stainless steel sheet furnished to higher mechanical properties than are available in other commercial high tensile grades in the full hard condition.

These sheets are rolled to extremely close tolerances (as low as plus or minus 3%) with micro-accuracy and precise uniformity of gauge. The surface of Micro-Mach sheet is smooth, clean and dense; qualities so important in minimizing surface friction.

For further information write to Aircraft Steels Dept.

**Washington Steel Corporation**  
11-H WOODLAND AVENUE  
WASHINGTON, PA.



MicroMach stainless steel is also available in all popular grades and to meet regular government specifications. Sheets up to 36" wide can be had as thin as .005", and over 36" to 48" wide as thin as .010" in all commercial finishes and tempers.

## ... missile electronics

calibrations, complicated instrumentation designed and adjusted for a single, fixed operating frequency is usually required. The fixed frequencies chosen by the bureau meet the great majority of requirements, as determined by analysis of calibration requests over the past few years.

A recent development program has produced a superior waveguide-below-cutoff attenuator which extends the available calibration accuracy well beyond that of previous standards. Attenuators of this type will be used as

attenuation standards in the center. These are being incorporated into special calibration consoles, using a two-channel, null detection, direct substitution measurement system. Pending completion of this instrumentation, a limited calibration service is being maintained using other equipment.

### • High Frequency Field Strength—

The center offers a calibration service for field strength meters in the frequency range from 30 cps to 300 Mc. The overall linearity of the instrument, the internal attenuator ratios, and the antenna coefficients can be measured,

and the instrument can also be calibrated as a two-terminal rf voltmeter. All calibrations are made in terms of sinusoidal voltages and currents. The instrumentation used for this work is continuously tunable over the radio part of the stated above frequency range.

The attenuator ratios and the overall linearity of the field strength meter are measured in terms of precision dissipative coaxial step-type attenuators, calibrated against a standard waveguide-below-cutoff attenuator. Field strength meters using either loop or dipole antennas can be calibrated.

### • Microwave—

Microwave facilities are being provided at the center to measure attenuation, power, frequency, and impedance. The frequency range to be covered extends from 300 to 40,000 Mc for attenuation, power and impedance calibrations, and to 75,000 Mc for frequency calibrations. For components utilizing standard 3/8 in. rigid coaxial terminals with standard Type N connectors, calibrations will be made over the frequency range from 300 to 4,000 Mc. For components utilizing standard rigid rectangular waveguide terminals with standard waveguide connectors or flanges, calibrations will be made over the frequency range 2,600 to 40,000 Mc, and up to 75,000 Mc for frequency calibrations.

### • Microwave Attenuation—

Attenuators are usually calibrated by the I-F substitution method. In this method, power is fed through the microwave attenuator and, after frequency conversion, through a standard 30 Mc attenuator. The standard is a cylindrical section of waveguide operated below cutoff and having attenuation properties that are accurately determined by calculation, precise construction, and evaluation. Microwave attenuators are calibrated in terms of this standard.

Due to limitations in the linearity of the frequency conversion process, attenuation values above about 40 db are measured by the direct substitution method. In this method, microwave attenuators previously calibrated by the I-F substitution method are connected in series with the unknown and are used to determine its attenuation.

### • Microwave Power—

Microwave power calibrations are made by comparing an unknown bolometer with a calibrated standard bolometer. In this method, stabilized continuous-wave power of a single frequency and constant level is fed into transmission-line terminals connected to the standard bolometer or to an unknown bolometer. Both the standard and unknown

(Continued on page 71)



Outstanding  
Engineers  
and Scientists  
to  
help solve  
"out of this world"  
problems...

Today artificial satellites orbit in space. Missiles can span continents. Conservative scientists calmly talk of landing on the moon.

Just as they have contributed to other aeronautical sciences, the various divisions of United Aircraft Corporation have made significant contributions to these new fields of missiles and space technology.

Recently the outstanding scientists and engineers who had specialized in missiles, missile guidance and space penetration problems in each division were brought together to focus their combined skills on advanced concepts and systems. A new Division was created... the Missiles & Space Systems Division.

This division is only weeks old. It is in an explosive growth period. Yet it has a built-in stability factor... the advantages of the brainpower, the "know-how", the financial resources and the unique facilities of a billion-dollar corporation that is already pre-eminent in aeronautics.

This combination of newness and stability should be significant to every alert engineer or scientist. It should suggest a unique opportunity to demonstrate ability and win the advancement and other rewards that ability deserves.

If you are looking for opportunity, we suggest that you contact us immediately.

Positions are available at all levels in...

**ELECTRONICS:** Guidance, Radar, Countermeasures, Computers, Telemetry • **SYSTEMS ANALYSIS** • **SYSTEMS INTEGRATION** • **MILITARY REQUIREMENTS** • **RELIABILITY** • **GROUND SUPPORT** • **SPACE TECHNOLOGY:** Astrophysics, Astronautics • **AERONAUTICS:** Preliminary Design, Performance, Aerodynamics, Structures, Propulsion.

Please send your complete resume, including salary requirements, to Mr. John B. North.

## MISSILES & SPACE SYSTEMS DIVISION

UNITED AIRCRAFT CORPORATION • EAST HARTFORD 8, CONNECTICUT



# new missile products

## High Temperature Cathode Ray Tubes for Radar

Cathode ray bulbs made of optical quality high temperature alumina-silicate glass are now available from **Corning Glass Works**.

Virtually free of physical imperfections, the bulbs are particularly applicable to high resolution radar surveillance systems. Alumina-silicate glass can be optically melted. Flaws can be held to .001 of an inch or less in size. The glass withstands tube proces-



sing and/or operating temperatures up to 700C. It is ideally suited for applications where, as in cathode ray tubes, extremely high temperatures are required in screen-baking transparent phosphors to the faceplate.

Alumina-silicate glass is resistant to radiation, and has good thermal shock resistance and good electrical properties.

Circle No. 225 on Subscriber Service Card.

## Subminiature Terminal Facilities Available

Twelve subminiature Teflon terminals are comfortably accommodated on a dime. **Sealectro Corp.**'s "Press-Fit" type FT-SM-125 feed-thru has a new truncated end for one of the two lugs, acting as a stop to prevent wrapped wire leads from slipping off until they can be soldered. The other lug is the usual plain pin.

Type FT-SM-125 measures .306" in overall height. It fits into a .081"

diameter hole, and can be accommodated in any chassis up to .035" thick. It is available in code colors including red, blue, yellow, green, brown, orange, gray, purple and black, as well as white.

Circle No. 226 on Subscriber Service Card.

## Spectrum Analyzer Model 1s Marketed

**B & K Instruments, Inc.**, Cleveland, Ohio, is marketing a new audio frequency spectrum analyzer featuring true RMS, average, and peak readout, switch selected. It is of the 1/3 octave type with center frequencies ranging from 40 to 32,000 cps. Additional low range filters are available.

Characteristics of the 30, 1/3 octave filters are: tops flat within  $\pm 1/2$  db; steep sides with maximum slope of 120 db per octave; skirt selectivity greater than 50 db per octave and

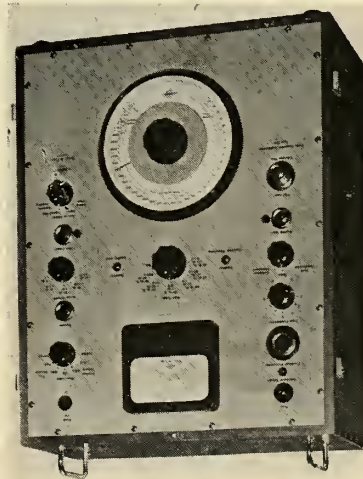

greater than 70 db per 2 octaves from the center frequency.

Spectrum analyses are automatically plotted on a frequency-amplitude calibrated chart when this analyzer is associated with the B & K instruments, Model 2304 Level Recorder.

Circle No. 227 on Subscriber Service Card.

## Combination Electrical And Oxygen Disconnect

A new combination electrical and oxygen quick coupling from **Perfecting Service Co.** supplies necessary oxygen,

electrical heating and communications through a single unit. This feature reduces connecting or disconnecting time and the number of lines an operator would have to handle.

The coupling is small and weighs one and one-half ounces. It is designed so that when connected, the seal will engage before electrical contacts are made, and conversely when disconnected. This feature makes the coupling applicable with inert gases, inflammable gases and all types of oxygen service.

Fast, easy, one-hand patented

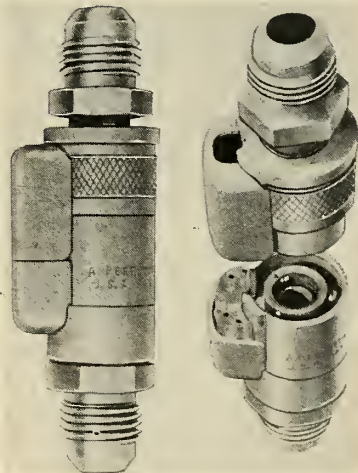

"Pulomatic" action is featured. It locks automatically—without turning or twisting and forms a positive leak-proof connection. Flow: 27 CFM at

**NOTE:** For additional information about any product mentioned in this section of Missiles and Rockets use the attached prepaid reply cards. Circle numbers shown on the reply card that correspond with numbers appearing beneath items described. If no circle number accompanies the article or advertisement, give page number (and advertiser's name) on line provided at bottom of the card.

Your requests for information will be forwarded promptly to the companies concerned.

The Editor

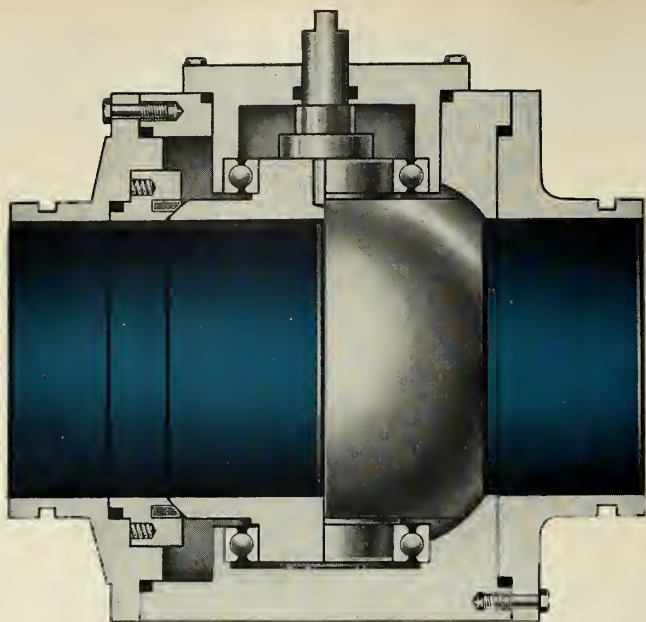

# HYDROMATICS *FLO-BALL*® VALVES

The accepted standard of maximum performance and reliability

## 100% FLOW EFFICIENCY

Hydromatics' exclusive FLO-BALL design provides a straight-thru unrestricted fluid path, exactly equal to the pipe line diameter.

## PERFECT SEALING

Zero leakage is assured through the use of a precision ball—the ideal geometric form for perfect sealing contact.

## LOW OPERATING TORQUE

Ball rotates in precision bearings which absorb all pressure loads. Pressure balanced valve seat further minimizes forces on ball, reducing frictional drag.

## LONG LIFE

Seat is always in sealing contact with the ball surface, resulting in a self-wiping, self-lapping action that insures long, trouble-free life.

## HIGH SPEED ACTION

Only 90-degree rotation is required to fully open or close valve. Full travel as fast as 5 milliseconds.

## RELIABILITY

Simple construction, with only one rotating part, provides built-in reliability and rugged, dependable operation.

## CRYOGENIC AND CORROSIVE APPLICATIONS

Hydromatics' FLO-BALL valves, with new diaphragm sealing and unrestricted fluid path, have been proved the best valves for operation with LOX, Liquid Nitrogen, Helium, Hydrogen Peroxide, Red Fuming Nitric Acid and Hydrazine.

## MODULAR ARRANGEMENT

Only FLO-BALL design, with its rotating valve action, permits side-by-side grouping of several valves, all driven simultaneously by a single actuator.

## VERSATILITY

Only FLO-BALL design makes possible the interchanging of manual, motor or pressure actuators without changing the valve body.

*HYDROMATICS, the world's leading designer and manufacturer of high performance ball valves for military and industrial applications, offers the most extensive selection of designs to meet all your requirements; Manual, motor or pressure operated. For cryogenic, corrosive or general service media. Pressures from vacuum to 10,000 psi. Sizes from 1/4 inch to 12 inches.*

**Hydromatics, Inc.**

**70 Okner Parkway, Livingston, New Jersey**

## Hydromatics, Inc.

HYDROMATICS FIELD ENGINEERING OFFICES:

Pasadena, 35 N. Arroyo Pkwy., RYon 1-7448 / Denver, 829 15th St., AMherst 6-2714 / Washington, 1413 K St. N. W., STerling 3-3612



## ... new missile products

90 psi. Operating pressure to 250 psi. Temperature: Minus 85° to 300°F.

Coupling will deliver 150 liters of oxygen at 90 psi with less than one pound pressure drop.

Circle No. 228 on Subscriber Service Card.

### New Mold Design For Commutation Plates

Supramica 555 ceramoplastic commutator plates provide new standards for the molding of dimensionally accurate electronics parts containing inserts. The new development, by **Mycalex Corp.** of America, has mold

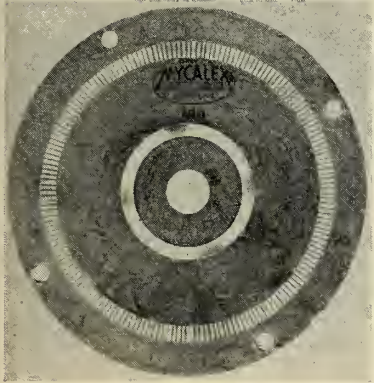

accuracy of  $\pm 1$  minute in the positioning of rectangular inserts.

The commutator plate produced by the application of these new techniques is for a low noise level, telemetry switch. 180 contacts providing 90 individual pulses in a contact ring  $2\frac{1}{2}$  inches in diameter, with contact size .030" diameter.

The Supramica 555 ceramoplastic commutator plate produces low level signaling unattainable with any other type of plate, and has the added advantages of accurate reproducibility, permanent dimensional stability and anticipated operating life of over 500 hours at 600 rpm.

Circle No. 229 on Subscriber Service Card.

### Precision Potentiometer Available In Miniature

The Model 1410 Helical Potentiometer, manufactured by **S. A. Asquith Co.**, is a 1 watt, 200 to 25,000 Ohms Pot for use where the handling of a multiplicity of circuits in the smallest possible panel area is required.

The shaft, front bushing and bearing of the Model 1410 are manufactured from corrosion resistant nickel silver (18% Ni). Wiping contacts are

fabricated from noble metal laminates. Bearings are provided front and rear and the shaft and wiper are electrically isolated. The stop mechanism is associated only with the shaft, permitting rotational accuracies otherwise impossible in so small an instrument. Stop strength is better than eight inch-pounds. The shaft does not move axially in and out with rotation.

The Model 1410 will withstand accelerations of up to 50 G's in three planes without electrical or mechanical damage and without wiper deviation from a set mechanical angle. Due to the balanced design of the wiper system, shaft locks are not necessary under any normal service conditions.

Circle No. 230 on Subscriber Service Card.

### New Simulation Table Hydraulically Operated

A single-axis flight simulation table for testing components under simulated pitch, yaw and roll maneuvers has been announced by **Genisco, Inc.**

The Genisco A916 Single-Axis Flight Simulation Table may be used with an analog computer, function generator, tape recorder, and digital-to-analog converter to evaluate autopilot systems and to determine the dynamic characteristics of high performance gyros, such as threshold, static friction, and non-linear behavior can be determined with accuracy.

Actuation of the table is accom-

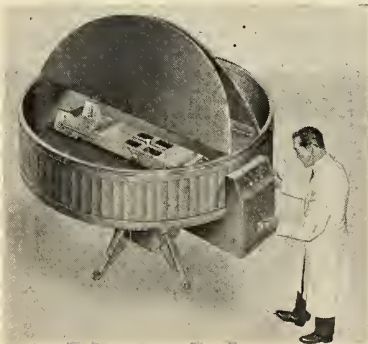

plished hydraulically. Two pistons operate in a push-push configuration controlled by a high-gain servo system. Since the actuator is symmetrically located about the table axis of rotation, a uni-directional restraining force eliminates any possibility of mechanical backlash and allows continuous control in the operation of the close-loop servo system.

Circle No. 231 on Subscriber Service Card.

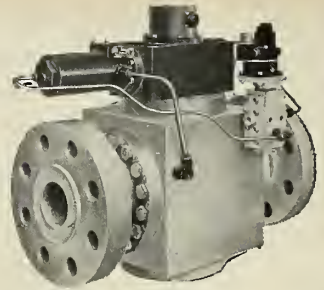

### FAST-ACTING 3" FLO-BALL VALVE 7 millisecond operation at 4000 psi

Pressure actuated 100% flow efficiency ball valve opens or closes a 3" line in only 7 milliseconds, working against 4000 psi liquid or gas pressure at temperatures up to 250°F.

The fast action results from a built-in high pressure air accumulator, controlled by an integral explosive squib pilot valve. A low amperage electrical impulse sets off the squib, opening the accumulator allowing air pressure to actuate the valve. The cycle is accomplished in 7 milliseconds.

The unit includes a built-in meter operated 4-way selector valve, used to simplify accumulator recharging and also to recycle the valve. Accumulator may be charged prior to actual valve operation and then stored far up to one year without recharging.

Valves are being used far fast, precise flow control in high pressure missile and aircraft fueling systems, catapult launchers and emergency extinguisher systems.

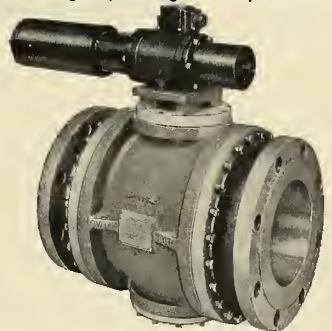

### 6" LOX FLO-BALL VALVE 100% flow efficiency, minimum size and weight

Pressure actuated ball valve, designed expressly for LOX flow control in airborne and ground support applications. The sealed double-acting actuator, specially developed by Hydramatics, is thermally isolated from the valve body to guarantee fast, positive action at extreme low temperatures. Operating times from 30 milliseconds to 2 seconds, at 150 psi rated line pressure.

Valve includes a sealed, rotary action snap switch for remote observation of the valve position. Switch design allows external adjustment.

To facilitate installation and maintenance, the flanges are removable and interchangeable.

**Hydramatics, Inc.**

70 Okner Parkway, Livingston, New Jersey  
Circle No. 47 on Subscriber Service Card.



**Experience—the extra alloy in Allegheny Stainless**

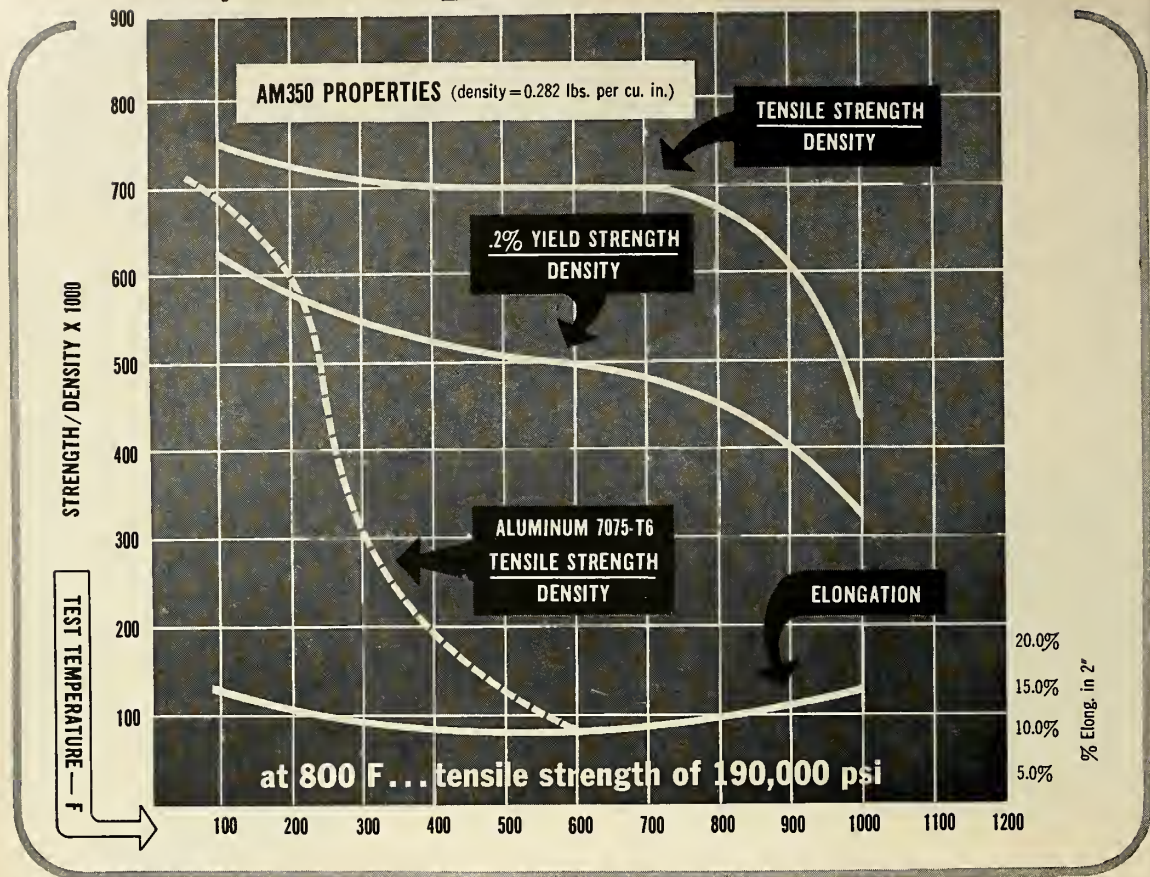

**Here are the facts on AM350 and AM355, Allegheny Ludlum's precipitation hardening stainless steels**

A unique combination of highly desirable properties is the usual description of Allegheny Stainless AM350 and AM355 Steels. They combine high strength at both room and elevated temperatures, excellent corrosion resistance, ease of fabrication, low temperature heat treatment, good resistance to stress corrosion.

They are proving the answer to many problems of the air age. Airframe and other structural parts, pressure tanks, power plant components, high pressure ducting, etc. are all natural missile and supersonic aircraft applications for AM350 and AM355.

**Availability:** AM350, introduced several years ago, is available commercially in sheet, strip, foil, small bars and wire. AM355, best suited for heavier sections, is available in forgings, forging billets, plate, bar and wire.

**Corrosion resistant:** Being stainless steels, these alloys resist corrosion and oxidation. Compared to the older, more familiar stainless grades, their corrosion rating is better than the hardenable grades (chromium martensitic) but generally less than the old corrosion resistant standbys, the

18 and 8's. Stress corrosion is resisted at much higher hardness levels than with martensitic stainless.

**Simple heat treatment:** High strength is developed by two methods, both involving less than ordinary temperatures and minimizing oxidation and distortion problems. The most popular, and one that develops slightly better properties, is the Allegheny Ludlum developed sub-zero cooling and tempering (SCT condition). The material is held at minus 100 F for 3 hrs plus 3 hrs at 850 F. Alternate method is Double Aged (DA): 2 hrs at 1375 F plus 2 hrs at 850 F.

**Easy fabrication:** AM350 and AM355 can be spun, drawn, formed, machined and welded using similar procedures as with the 18-8 stainless types. In the hardened condition (SCT & DA) some forming may be done . . . 180 degree bend over a 3T radius pin. Also it can be dimpled in the hard condition to insure accurate fit-up.

For further information, see your A-L sales engineer or write for the booklet "Engineering Properties, AM350 and AM355." *Allegheny Ludlum Steel Corporation, Oliver Building, Pittsburgh 22, Pa.* Address Dept. MR-11.

WSW 7327

**ALLEGHENY LUDLUM**

Export distribution: AIRCO INTERNATIONAL

EVERY FORM OF STAINLESS . . . EVERY HELP IN USING IT





bolometers are considered as complete units consisting of a bolometer element in a suitable mount with a single pair of rf transmission-line terminals available for connection to the system.

A measurement, at the same frequency, of the reflection coefficient of an unknown bolometer is used to determine the reflected power. This, in conjunction with the previous measurement, can be used to determine the actual power absorbed by the bolometer, and hence, its efficiency.

The standard bolometers have been carefully designed, fabricated, elevated for all known errors, and calibrated in a microcalorimeter. All calibrations made by the center are in terms of these bolometers. Different standard bolometers are used for each transmission line size.

• **Microwave Frequency**—Frequency measurements for calibration purposes are made by direct comparison of the resonant frequency of a wavemeter cavity with the frequency of an accurately known signal (marker frequency). The basic reference standard for frequency measurements is a 100-kc signal obtained directly from the national standard of frequency. The 100-kc signal is multiplied through harmonic generation in conventional vacuum tubes and klystrons to provide several low-and high-frequency marker signals. These frequency marker signals become the references used in calibrating cavity wavemeters.

• **Microwave Impedance**—At present microwave impedance calibrations are not available at the Electronic Calibration Center. However, results of recent research in the Radio Standards Laboratory point the way to a calibration service, initially at X-band, within the next year, and work has begun on implementing this service.

## Amphenol-Borg Merger Is in Planning Stage

Directors of Amphenol Electronics Corporation, Chicago, and the George W. Borg Corporation, Delavan, Wisc., have approved a plan to merge the two companies.

The merger, which will be subject to approval at special stockholders' meetings to be held December 30, will result in the formation of Amphenol-Borg Electronics Corporation. Owners of Borg will receive one and one-third shares of Amphenol-Borg for each share now held; while the number of shares in the hands of Amphenol shareholders will remain unchanged.

The merged company will have

# IN SILICONES OR RUBBER

## WHAT'LL YOU HAVE?

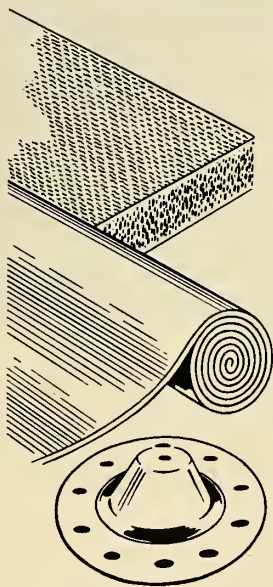

**SPONGE?** Chemically blown, closed-cell silicone sponge is available in fine, medium, and firm density; skin thickness can be varied to suit. Excellent for gaskets, seals, shock mounts, light duty press pads, die cut parts.

**SHEET?** Solid sheet is produced from 1/32 to 1 in. thick, 20 to 80 durometer, in compounds to meet all AMS, ASTM, and military specifications. For gaskets, seals, bushings, die cut parts, diaphragms, heavy duty press pads. Laminated press pads and throw sheets are also available.

**MOLDED PARTS?** Diaphragms, pipe coupling gaskets, regulator parts, medical kit liners, bumpers, flexible coupling discs, spring inserts, aircraft test sleeves, and many other components are produced to rigid specifications.

Hewitt-Robins, prominent in development of aircraft refueling hose, makes many silicone and rubber products for the aircraft and missile industries. These components are fabricated using all elastomers, including silicones by themselves or with various fabric or metal reinforcements.

Specialists in our Aircraft Products Department can help you put today's new compounds to best use in aircraft, missiles, and rockets. For information, service, or your copy of comprehensive Product Bulletins, contact your local H-R representative, or Hewitt-Robins, Stamford, Connecticut.



## HEWITT-ROBINS

CONVEYOR BELTING AND IDLERS . . . POWER TRANSMISSION DRIVES  
INDUSTRIAL HOSE . . . VIBRATING CONVEYORS, SCREENS & SHAKEOUTS

H-R Product Manufacturing Plants in Buffalo, N.Y. • Chicago, Ill. • King of Prussia, Pa. • Passaic, N.J. • Amsterdam, Holland • Johannesburg, South Africa • London, England • Montreal, Canada • Paris, France

# RED HOT

## AND HONEYCOMB!



This missile component is typical of structures now in production.



## AERONCA brazed stainless steel structures

*Working with existing fully-integrated facilities, Aeronca is producing and delivering a variety of brazed honeycomb sandwich components for aircraft and missiles. Flat, wedged, conic, contoured and compound curved configurations are produced daily by specialists in high-temperature structures.*

Aeronca . . . a pioneer in stainless steel honeycomb development . . . is capable of designing, developing and producing any major airframe or missile component involving honeycomb sandwiches.

A technical team is available, on written request, to make specific presentations on Aeronca's facilities for high-temperature air weapon structures. Write today for additional information.



**AERONCA**

manufacturing corporation

1716 Germantown Road • Middletown, Ohio

8261-AC

Expansion of our operations has created openings for additional senior engineers. Write to Mr. L. C. Wolfe, Chief Engineer.



over 7,500 shareholders, 3,500 employees, with annual sales exceeding \$50 million and total assets exceeding \$37 million.

Arthur J. Schmitt, president of Amphenol will be chief executive officer of the new company. The Borg firm, long known as a leading manufacturer of automobile parts, produces potentiometers and other electronic equipment which has become increasingly important in recent years and will supplement the broad Amphenol product line.

Amphenol Electronics, which last year celebrated the 25th anniversary of its founding by Schmitt, makes a wide variety of electrical connectors, coaxial cable, cable assemblies and harnesses.

In August, 1957, it acquired Danbury-Knudsen, Inc., of Danbury, Connecticut, which added to its product line in the connector and electronic specialty fields.

The George W. Borg Corporation was established in 1935 by Mr. Borg, one of the founders of Borg-Warner Corporation of Chicago. Mr. Borg will remain active in the Amphenol-Borg Electronics Corporation as a director and Chairman of the Executive Committee.

### Lockheed Trains Navy Personnel on Polaris

Planning to produce trained crews simultaneously with the *Polaris* missile system they will operate, Lockheed's Missile Systems Division is now pushing an intensive training program for a group of 78 Navy enlisted men and 6 officers.

Under its contract with the Bureau of Naval Personnel, Lockheed is responsible for training, either directly or through subcontractors, of specialist personnel. Training is being conducted at the company's Sunnyvale, Palo Alto and Santa Cruz Mountains facilities.

At the same time, the group is also receiving instruction in propulsion at Aerojet-General Corp.; in fire control at General Electric's Pittsfield (Mass) plant, and in launching systems at Westinghouse's Sunnyvale plant.

The trainees receive a week of formal classroom indoctrination from members of Lockheed's training and job analysis department; then begin on the job training, supplemented by classroom sessions.

Nine Fleet Ballistic Missile submarines are planned. With the normal complement of each submarine being 100 or more, Lockheed can be expected to eventually train more than 1,000 crew members.

# Don't Be a Count-Down Casualty 11-10-9-8 HOLD...



Product placed in Paratex rubberized curled hair pack formed to provide a completely Static Shape that fully Neutralizes the Weight.

## USE BLOCKSOM

# Paratex

## CUSTOM-CUSHIONING FOR PRODUCTS THAT MUST NOT FAIL

Don't let your product be a "count-down" casualty because of vibration damage. Blocksom Paratex cushioning safely cradles your product, practically eliminating shipping hazards that cause component malfunction.

### CUSHIONING DESIGNED AROUND THE PRODUCT

For over 25 years, Blocksom engineers have been designing and developing special Paratex products to meet the rigid requirements of industry. The finished Paratex shipping pack combines the springiness of curled hair with the natural resilience of latex rubber which gives unsurpassed shock resistance, dampens vibration, is exceptionally light in weight, resists moisture, fungus, and is highly efficient at all temperature ranges. Results in safe arrival for your most delicate instruments.

PHONE COLLECT or WRITE TODAY for free consultation on your packaging problems

### BLOCKSOM & COMPANY

Packaging Division  
MICHIGAN CITY, IND.  
Packaging Representatives  
in All Principal Cities

BLOCKSOM & COMPANY  
Michigan City, Ind., Dept. MR11

- Send me folder on Paratex Packaging
- Have packaging engineer call

Name \_\_\_\_\_

Company \_\_\_\_\_

Address \_\_\_\_\_

City \_\_\_\_\_ Zone \_\_\_\_\_ State \_\_\_\_\_

# NEW! AiResearch split-flapper check valve



*Extremely compact  
and fast closing*

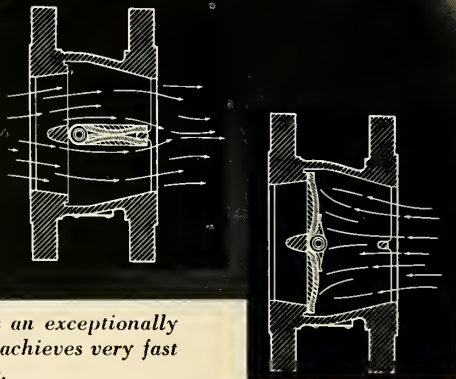

*The new AiResearch Split-Flapper Check Valve provides an exceptionally clean flow of any gas or liquid through the valve area. It achieves very fast closure with no leakage in the return flow.*

This extremely compact, lightweight unit has important applications in petroleum, chemicals, paint, food processing, missile fuels . . . any industry with a gas or liquid flow problem. The valve can be made from various materials, covering an operational temperature range from cryogenic levels to 1700° F.

The AiResearch Split-Flapper Check Valve pictured above is made of aluminum . . . rugged and dependable with only two mov-

ing parts. Twin forged flappers, opening in the direction of normal flow, are supported through the center of the piping. In the event of backward flow, their spring mounting and aerodynamic design assure fast closure of the valve.

Insertion of short flapper plates through the bore eliminates exterior bonnet and gasket joint and reduces length. Other structural advantages are better support of the plates, greatly re-

duced shock loads on the hinges and sealing surfaces, reduced springload, less mass and material to be heated or cooled by the flow element.

Ideal for portable as well as stationary applications, the new AiResearch Split-Flapper Check Valve can accommodate lines 1 to 12 inches in diameter. AiResearch has 17 years of experience in the production of valves and controls.

Your inquiries are invited.



**AiResearch Industrial Division**

9225 South Aviation Blvd., Los Angeles 45, California

DESIGNERS AND MANUFACTURERS OF TURBOCHARGERS AND SPECIALIZED INDUSTRIAL PRODUCTS



# west coast industry

by Fred S. Hunter

There are a number of reasons why the outcome of the Boeing Airplane Co.'s renegotiation case before the U.S. Tax Court is significant to the industry.

One, of course, is that there is no appeal from the decision. The U.S. Tax Court's word is final.

But more important is that the rate of profit which the court allows Boeing in this case may very well set a pattern for the industry. In other words, the companies will get a good idea of how much profit they will be allowed to make from here on out, or at least as long as we have renegotiation.

This is not to imply that if the court fixes a profit rate of, say, 8.6% for the Boeing company, it is going to fix the same 8.6% rate for some other company. Every renegotiation case is a different deal and is considered separately. Even for Boeing the court may establish a rate of profit for the year 1952, the year now under consideration, and change it for the year 1953 when the case for that year comes before it.

But it is highly probable that the rate of profit the court decides upon in the first air industry renegotiation case to come before it will be used as a guidepost in establishing rates of profits for Douglas or North American or any other company appealing the excess profit claims made by the Renegotiation Board.

From the strictly legal standpoint, the Boeing hearing in Seattle will set an important precedent in the ruling of the trial judge on evidence. While the decision which the court will hand down will be made by the entire bench of 15, only one judge sits at the hearing and rules on the evidence the company and the government are permitted to introduce.

All signs indicate that the Renegotiation Act is set for a going over from the next Congress. Originally designed to protect the government during the war period when military production consumed most of the nation's industrial capacity without competitive restraint, renegotiation was reenacted in 1951 during the Korean conflict and has since been continued in effect.

It has been assailed on all sides, by big business and by small business, by prime contractors and by subcontractors, as hindering cost reductions, impeding technological progress, penalizing efficiency and destroying incentive.

The Boeing company was the reestablished Renegotiation Board's first target. After having been "cleared" by the regional board for 1952, the Seattle manufacturer's return for that year was declared to have been excessive in the amount of approximately \$10 million, before taxes, upon the determination of the national board. The following year Douglas, Lockheed, North American and others, as well as Boeing, were determined to have netted excessive profits on their military contracts.

## 28 volts powers this transistorized vibration amplifier



Consuming only a fraction of the power required by tube type units, taking  $\frac{1}{3}$  the space, and operating directly from a 28 volt battery, this GLENNITE transistorized amplifier fills all requirements for airborne application.

Unique design and rugged construction assure extremely low microphonics, provide high input impedance for direct use with piezoelectric accelerometers.

A companion light weight, 3-channel battery pack is available. This unit contains a rechargeable, sealed nickel cadmium battery capable of powering 3 transistorized amplifiers for 16 hours.

Like more data on these units? Contact your local Gulton representative, or write us direct.

### SPECIFICATIONS

Gain: Continuously variable from 10 to 100  
Input impedance: 30 megohms minimum  
Power input: 28 v dc at less than 3 ma  
Frequency range: 10 cps to 20 KC  
Temperature range: up to 200° F

### Call in Gulton

Whether you need a single instrument or a complete system, Gulton is capable of meeting all your needs in shock and vibration measurement from transducer to readout equipment. Call in a Gulton Instrumentation Engineer on your next assignment — or on your present one if you have a problem.

GULTON INSTRUMENTATION DIVISION



**Gulton  
Industries,  
Inc.**

Metuchen,  
New Jersey

Circle No. 50 on Subscriber Service Card.

**Wrap-around  
bumper for  
a continent**

# NORAD

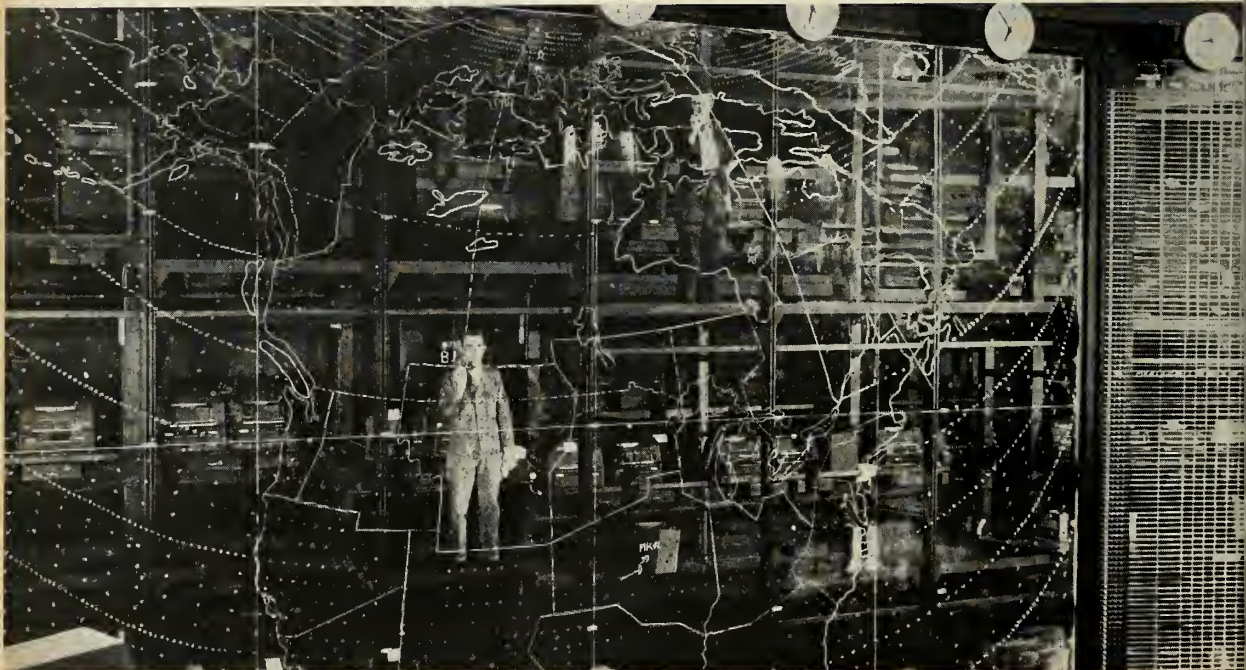

Headquarters—NORAD—Colorado Springs

Like a huge "bumper" wrapped around the North American continent and reaching down along both the Atlantic and Pacific shores, the North American Air Defense Command (NORAD) has been created for operational control of air defense units of the Army, Navy and Air Force of the U.S. and the RCAF Air Defense Command of Canada. Its field includes the vast area between the southern border of the United States and the

northernmost limits of Canada and Alaska. Under the functional control of NORAD will be BMEWS (Ballistic Missile Early Warning System) and SAGE (Semi-Automatic Ground Control Environment) for the defense of specified sectors. In addition to its responsibility as prime contractor for BMEWS, the Radio Corporation of America is working on other important electronic assignments for NORAD.



Tmk(s) ®

**RADIO CORPORATION of AMERICA**

DEFENSE ELECTRONIC PRODUCTS

CAMDEN, N. J.



# world astronautics

by Frederick C. Durant III



The first interplanetary probes may not be launched until the 1960's. Much thought has already been given to the most significant measurements that might be telemetered by rockets to the vicinity of the planets. Venus and Mars will be the first planets to be studied. Mercury is too hot and the others are too far away. Early probes will simply pass (hopefully) within a few hundred miles of the target or, possibly, impact on the surface. More sophisticated systems with course-altering rockets will be used as inertial guidance systems with fantastic accuracies by today's standards.

The mass of the planets can be determined from trajectory deviations of the probe itself as it nears the body. For eventual sophisticated systems, astronomer Gerard de Vaucouleurs of Harvard College Observatory has suggested three different observation methods: optical, spectroscopic and radio.

For Venus, radio ranging could determine the depth of the atmosphere cloaking the planet from view and the true diameter of the globe. High dispersion spectra of the upper atmosphere and radio sounding for possible ionosphere are also suggested.

Since we know much more about Mars, more detailed studies can be expected. Optical observations would be particularly interesting. A 10-inch telescope at 1,000 miles above the surface could, according to de Vaucouleurs, show "spots as small as 100 ft. in diameter or lines 25 ft. in width." Such observations would possibly solve existing hypotheses on canals, volcanoes, polar caps and vegetation.

Spectroscopic tests of Martian atmosphere could be carried out between two ships, or one ship and a reflecting mirror. Spectra from surface reflected light, especially in the infrared, of the dark areas could be used for the detection of weak but significant bands; e.g., OH bond absorption.

Radio observations might include continuous ranging in closed orbit for surface relief, completely unknown at present. Variable frequency sounding would detect an ionosphere or ionized layers. Other desirable measurements would be magnetometer mapping of the general magnetic field and the firing of smoke-trailing rockets into lower atmosphere for wind studies.

An interesting point of relative emphasis may be found under the heading *Rocket* in a well-known one volume encyclopædia published in 1950. Two 19-line paragraphs describe the word "Rocket." One description commences, "Projectile propelled by a force within itself . . . etc." The other, equal length paragraph, which appears *first*, commences, "Popular name for several plants of the mustard family . . .!"

Plastics for high temperature use have been delineated by General Electric Co. Conclusions are applicable to missile skins, plastic motors, blast tubes, nozzles, and parts for plasma jets. High carbon plastics—particularly phenolics, are good. Reinforcing fiber orientation should be random. Up to 3,000°K silica fibers are better than glass. Nylon fibers erode less than glass, however. Other organic fibers may be better than either. High glass fiber content give higher mechanical strengths, but cutting down on fiber at rocket plasma jet temperatures eases thermal erosion.

Solid propellant extrusion studies conducted by Naval Ordnance Test Station at China Lake indicate that it is safer and more economical to use several small presses than one large unit. Cylinder diameter doesn't limit grain size too much. Tests were carried out with N-4 double base propellant.

Latest hot fuels for ramjets at high altitudes are the organic sulfur compounds such as carbon disulfide or dimethyl sulfide. Most give high flame speeds and offer unusually high altitude blowout resistance.

## Avoid false test results with GLENNITE internally ungrounded accelerometers

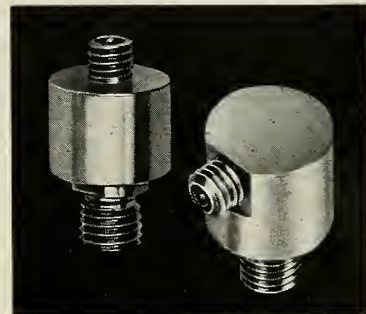

Now you can avoid one of the major causes of false test results — spurious "ground loop" voltages — by using *internally ungrounded* GLENNITE accelerometers.

These units contain sensitive seismic elements *internally* insulated from the mounting stud by rugged ceramic insulation. You can employ a *single point ground* at the data handling or recording equipment by using a combination of these accelerometers with ungrounded GLENNITE amplifiers and filters.

GLENNITE accelerometers are available in uni- and triaxial models — wide acceleration and temperature ranges.

A complete line of associated ungrounded electronic equipment includes filters, amplifiers, connectors and other related units.

For complete data on Gulton instrumentation systems — grounded or ungrounded — contact your local Gulton representative or write us direct.

### Call in Gulton

From transducer to readout, Gulton is capable of meeting all your instrumentation needs. If you have a measurement problem, why not call in a Gulton Instrumentation Engineer. His broad experience in shock and vibration measurement can prove invaluable to you.

GULTON INSTRUMENTATION DIVISION



**Gulton Industries, Inc.**

Metuchen, New Jersey

Circle No. 51 on Subscriber Service Card.



# solid footing?

To a man floating weightless around Space Station C, these are perhaps meaningless words—but *solid footing* is highly important to most of us who live and work on the surface of the earth.

Autonetics has established a solid footing in inertial guidance through 12 years of successful development and production of airborne and ocean-going systems, as well as systems for space applications.

The healthy growth of the Autonetics Guidance Engineering department—based on a number of highly diversified contracts—has created new senior-

level positions in the fields of electro-mechanical component development and system analysis.

Well qualified, experienced men will find solid footing in this permanent, progressive, and successful organization—plus the chance to create and to grow in one of today's most challenging fields.

But time's a-wasting. *Now* is the time to find out what the future holds for *you* at Autonetics.

Please send your resume to Mr. N. L. Benning, Manager, Employment Services, 9150 E. Imperial Highway, Downey, California.

NERVE CENTER OF THE NEW INDUSTRIAL ERA

**Autonetics**

A DIVISION OF NORTH AMERICAN AVIATION, INC.



missiles and rockets, November 17, 1958



## ... Hoover profile

(Continued from page 18)

and we used a steering wheel similar to that on a car," Hoover predicts, "anyone would be able to fly a plane or a space ship."

This system, Hoover says, would eliminate practically all instrument training, reduce accidents caused by misinterpretation of instruments and would lower costs of air and space vehicles. He points out, as an example, that some aircraft use as many as 13 gyros, each part of a subsystem; whereas the new system would use only one, with possibly an alternate standby.

Although the complete integrated system will not be ready for flight until about 1965, early versions will probably appear by 1960 and 1961. Meanwhile, interest is high in both industry and the services.

Dan Beard, assistant vice president of Equipment Research for American Airlines, calls the new concept "one of the most interesting developments to come along to simplify the pilot's job."

Beard, who has "flown" with the contact analogue in a Douglas simulator, said AA thinks it will have great value for easing the traffic control problem. "However," he added, "this is a revolutionary idea, and although it might possibly replace most of our present instrumentation, it will take time for this idea to sink in, as it did for our present system."

A spokesman for the Army Signal Corps Research and Development Laboratory, which has let a contract for development of the system for helicopters, and has observed and participated in tests, says:

"It certainly looks good to us. We are optimistic that it will pan out and if it does, it will accelerate, simplify and reduce the cost of training pilots."

Although Hoover's proposal is formally blanketed under the Army-Navy Instrumentation Program, the Air Force, which is studying less comprehensive instrument improvement projects, is watching progress on the concept carefully.

One underlying but significant aspect of the Hoover approach to the instrumentation problem was pointed out by AF Col. Taylor Drysdale, chief of Research and Analysis Division, Directorate of Development Planning.

"Fundamentally, the most important thing about Hoover's proposal is the principle of it with respect to research and development planning guidance. Instead of proceeding in basic and applied research through the hit or

(Continued on page 81)

# Smaller, Stronger Fasteners for the Aircraft Industry...



the **NEW**  
**CHERRY 3/32"**  
**Self-Plugging**  
**Rivet\* . . .**

- IN A-286 STAINLESS STEEL
- IN ALUMINUM
- IN MONEL

Where you need the strength of a solid rivet—in those impossible, blind installations—the new Cherry 3/32" Self-Plugging Rivet is the answer.

These Cherry miniature self-plugging rivets are now available in the industry-proven Cherry High Clinch configuration. Ideal for delicate installations in thin sheets with no damage to surrounding material.

A complete line of Cherry 3/32" Hollow Pull-Thru rivets is also available with either universal or 100° countersunk head.

For technical information write to Townsend Company, Cherry Rivet Division, P.O. Box 2157-Z, Santa Ana, California.

*\*Patents Issued and Pending*

## CHERRY RIVET DIVISION

SANTA ANA, CALIFORNIA

# Townsend Company

ESTABLISHED 1816 • NEW BRIGHTON, PA.

In Canada: Parmenter & Bulloch Manufacturing Company, Limited, Gananaque, Ontario

Circle No. 52 on Subscriber Service Card.



# research for rocket fuel control

Pumps, turbines, cryogenic hardware and fuel systems—everything short of firing the rocket—will soon be tested by a CEC process control system. Working with dangerous propellants and limited time, the system will provide complete, automatic programming, rapid control, and data in 30 seconds. Write for the complete story in Bulletin CEC 3016-X1.

systems division

**Consolidated Electrodynamics**

300 N. Sierra Madre Villa, Pasadena, California / Offices in Principal Cities Throughout the World

**CEC**

FOR EMPLOYMENT OPPORTUNITIES  
in this progressive company, write Director of Personnel.

From a central block house, the operator controls and reads air pressure, exhaust temperature, turbine speed, flow rate, pump suction pressure, and receiver tank pressure. The system automatically corrects for rates of change of test parameters to insure maximum data in limited time.





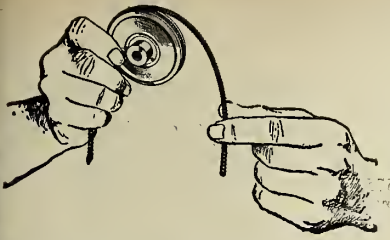

# A new key to Accuracy...

## IN JET ENGINE, MISSILE AND AIRCRAFT CONTROL LINKAGES

The unusual cable shown above is Teleflex—the unique “flexible rack” that is helping to solve mechanical motion problems in the control of jet engines, missiles and aircraft.

**HI-TEMP** mechanical feedback control linkages operating at temperatures exceeding 1200°F.

**HI-EFFICIENCY** control systems comparable to tension cable systems... but at 1/9th the space, up to 60% less weight. Operating on every major aircraft in the country.

- No external moving parts...
- Perfect pressure seal—no special fittings required...
- Natural thermal loop—no special provisions necessary to compensate for temperature changes...
- The ultimote in minimum lost motion...

Teleflex tubular conduit, routed along contours and around obstructions, guides the cable to remote locations, duplicating the motion at both ends of a system.



**DESIGN ENGINEERS—**  
For complete engineering data—send to Teleflex Incorporated, Church Rd., N. Wales, Pa., for your copy of Catalog 400.



Circle No. 53 on Subscriber Service Card. missiles and rockets, November 17, 1958

## ... Hoover profile

miss method, you proceed rationally in accordance with a rational design.

• **Schoolhouse R&D**—Seeking basic causes began in grade school for Pennsylvania-born Hoover. His mother made many trips to consult with teachers who complained that young George would not accept their teachings without continually asking “why?”

Hoover states matter-of-factly that his mental acquisitiveness has been getting him in trouble periodically ever since. “This type of curiosity is almost like a sickness. Not in the sense of being ill, but you can’t stop any more than you can stop eating. It is something you have to do. I have tried to forget trying to change things or trying to bring about anything new for short periods of time. I was completely upset. It is part of my basic nature.”

The Commander knows well the frustrations that accompany this drive. A case in point was cancellation of *Project Orbiter*, the original satellite program which was scuttled in favor of the *Vanguard* project. This came as a stunning blow to the man who had babied the project from the time he called the first meeting with Dr. Werner von Braun and other space scientists who agreed the project was feasible.

In an organization such as the Defense establishment where conformity is the rule, George Hoover’s individualism sets him apart. Although he does not thunderclap his differences with established procedure or accepted doctrine, stepping on the toes of convention, however softly, does not endear him to the docile majority. There have been many battles with prevailing opinion and they have left scars. But the “basic nature” always bounces back.

• **Space factors**—A recent Hooverism questions the necessity for conditioning man to meet such hazards of space flight as weightlessness. “Why should we condition him” Hoover asks, “to make up for the deficiencies of the equipment? Why should man be weightless in space?”

Man is always the guy who has to take the beating for the deficiencies of the equipment. And in space this cannot be. If you are going to put man out there, you have to give him the tools.”

Although the manager of ONR’s weapons systems accepts his apartness, he views with mixed feelings the fact that his 12-year-old son is heading in the same direction. “George has the same curiosity I do,” Hoover says shaking his head. “I know what he’s going to be up against.”



**BEFORE BOMARC GOES... PESCO POWER CHECKS-OUT WHERE IT'S GOING**

## Ground Support Package for Guidance Control

Designed and built by Pesco, working in close cooperation with FARNSWORTH ELECTRONICS CO., a complete “check-out” package assures accurate pre-launch testing of BOMARC’s guidance control system. The motor-generator features a Pesco Permanent Magnet Alternator—of 1.0 kva, 400 cycle power output at 3,000 rpm. The entire package including motor generator, magnetic amplifier type of voltage and frequency controls is contained in two sliding rack panels. Frequency regulation: ± 2%; Voltage regulation: ± 1% over a load range from 50-100%. Pesco creative engineering is offered, without obligation, to solve your Ground Support Equipment problems. Please contact:

**WESTERN BRANCH**  
**PESCO PRODUCTS DIVISION**  
Borg-Warner Corporation  
3310 Vanowen Street  
Burbank, California

Circle No. 54 on Subscriber Service Card.

# high-energy fuel briefs from Callery

**New HiCal plant dedicated at Muskogee, Oklahoma** — The nation's first large-scale high-energy fuel plant was dedicated on November 1 by the Navy at Muskogee, Oklahoma. Callery built and will operate the \$38-million plant for the Navy. When tonnage quantities of HiCal are produced at the plant next year, the high-energy liquid fuel will be used extensively in tests on various types of propulsion systems such as turbojets and ramjets. *Write for new Technical Bulletin, C-1110: HiCal-3 Compatibility with Materials of Construction.*

**Dayton, Ohio office opened by Callery** — Fuel and propellant users in the Dayton area can now utilize Callery's newly opened office to obtain technical service on their growing needs in aircraft fuels and propellants: 2600 Far Hills Avenue, Room 12, Dayton 19, Ohio; telephone AXminister 3-2752.

**New ignition-delay data on Triethylborane** — Just published data (C. J. Marsel and L. Kramer, Supplementary Preprint of Papers, Seventh International Symposium on Combustion, 655-61, Sept. 3, 1958) on Triethylborane (TEB) ignition delays: 20 msec. at 5 in. Hg, 50 msec. at 2 in. Hg, and 40 msec. at 0.5 in. Hg, with inlet air at 450°F. For JP-5-TEB mixtures at 450°F and 5 in. Hg, the delay is 170 msec. with 51.8% TEB and 200 msec. with 39.8% TEB; spontaneous ignition does not occur with 38.5% TEB.

TEB can be used as a pyrophoric ramjet fuel, as a reigniter for turbojets, and as an additive to improve combustion properties of JP and RP fuels. *Write for Technical Bulletin C-310 and Handling Bulletin C-311.*

**R & D Lab employees earn another safety award** — Employees of Callery's Research and Development Laboratories have earned two safety awards in the past year. Most recent achievement: 571,571 man-hours without a lost-time accident.

In the first six months of 1958, Callery's R & D employees have had one-third the number of accidents — and one-fiftieth the number of days lost from accidents — as the average of comparable chemical plants. *HiCal-3 Handling Bulletin C-1100 is available on request.*

Phone: FOrest 4-1130  
TWX: Perryssville, Pa. 117

Anthony C. Hummel  
Technical Representative  
Defense Products Department  
Callery Chemical Company



**CALLERY**  
CHEMICAL COMPANY

9600 PERRY HIGHWAY  
PITTSBURGH 37, PENNSYLVANIA

## contract awards

### AIR FORCE

By Headquarters, Air Force Office of Scientific Research, ARDC, Washington, D.C.:

**Syracuse University**, Syracuse, N.Y. received \$30,000 for research on the theory of irreversible processes.

**Lockheed Aircraft Corp.**, Missile Systems Div., Sunnyvale, Calif., received \$46,575 for research on the theory of composite propellant burning.

**California Institute of Technology**, Pasadena, Calif., received \$38,500 for continuation of research on selected problems in microwave electronics.

**The Catholic University of America**, Washington, D.C. received \$44,840 for research on electrochemical properties of metal-hydrogen alloys.

**Carnegie Institute of Technology**, Pittsburgh, Pa. received \$48,863 for research on optical properties of metals and alloys.

**The University of Michigan**, Ann Arbor, Mich. received \$27,150 for research on strong luminous shocks produced in shock tubes.

**Cornell University**, Ithaca, N.Y. received \$84,873 for continuation of research on new solid state defect structures.

By Cmdr. Hdqrs. AMC, Wright-Patterson AFB, Ohio:

**Sperry Gyroscope Co.**, Sperry Rand Corp., Great Neck, Long Island, N. Y. received \$1,340,000 for AN/TPW-1 microwave command guidance equipment, range and tracking test sets, radar sets, services and data to be used in the development of the XQ-4A drone.

**Northrop Aircraft, Inc.**, Hawthorne, Calif., received \$850,000 for crew procedures trainer evaluators for the SM-62A weapon system.

By Headquarters AF Cambridge RCAR&DC, USAF, Laurence G. Hanscom Field, Bedford, Mass.:

**Massachusetts Institute of Technology**, Cambridge, Mass., received \$4,500,000 for research services related to re-entry physics and instrumentation radar.

**The Pennsylvania State University**, University Park, Pa., received \$75,000 for research directed toward investigation of the physics, dynamics and general properties of the ionosphere.

**Brown University**, Providence, R.I. received \$49,982 for research directed toward the study of radiation of electromagnetic waves.

**Dynatronics, Inc.**, Orlando, Fla. received \$95,162 for a trailer, and portable field laboratory.

**The G. T. Schjeldahl Co.**, Northfield, Minn., received \$34,458 for design and fabrication of meteorological rocket balloons.

**Massachusetts Institute of Technology**, Cambridge, Mass., received \$25,000 for research directed toward the understanding of hydromagnetic shocks.

**Allied Research Associates, Inc.**, Boston, Mass., received \$29,953 for aeronautical engineering instrumentation development.

### ARMY

By U.S. Army Ordnance Dist., Phila., Pa.:

**Western Electric Co. Inc.**, New York, N.Y. received 16 contracts totaling \$997,395 for Nike spare parts & components.

**The Johns Hopkins University**, Baltimore, Md., received \$13,500 for theoretical and experimental studies of plastic wave propagation in longitudinal rods subject to impact and \$18,362 for research on the transient response of porous media and packed beds to large thermal and pressure fluxes.

### NAVY

By Dist. Public Works Officer, Sixth Naval Dist., U.S. Naval Base, Charleston, S.C.

**Nat G. Harrison Overseas Corp.**, Miami, Fla., received \$313,300 for additional base facilities at Antigua Island, British West Indies for the Air Force Missile Test Center offshore facilities.

By the Navy Department, Bureau of Ships, Washington, D.C.:  
**Skagit Steel & Iron Works**, Sedro-Woolley, Wash., received \$299,691 for missile handling crane.

By the Navy Department, Bureau of Ordnance, Washington, D.C.:

**Northern Ordnance, Inc.**, Minneapolis, Minn., received \$521,000 for job orders in connection with the emergency repair, overhaul, maintenance of guns, gun mounts and missile launchers.



## advertisers' index

AMP, Inc. .... 52	Hewitt-Robias Industrial Products ... 71
Agency—M. Russell Berger, Inc.	Agency—Fuller & Smith & Ross, Inc.
Aeronca Mfg. Corp. .... 72	Hexcel Products, Inc. .... 38, 39
Agency—Penn & Hamaker, Inc.	Agency—L. C. Cole Co.
Aeroquip Corp. .... 17	Huck Mfg. Co. .... 48
Agency—The Fred M. Randall Co.	Agency—F. B. Hubert Adv. Council
Aerofest Laboratories, Inc. .... 63	Hughes Aircraft Co. .... 22
Agency—Industrial Marketing Assoc., Adv.	Agency—Foote, Cone & Belding
Airborne Accessories Corp. .... 15	Hydromatics, Inc. .... 68, 69
Agency—Gray & Rogers	Agency—Industrial Marketing Assoc., Adv.
AiResearch Industrial Div.,	Kearfott Co., Inc. .... 23
The Garrett Corp. .... 74	Agency—Gaynor & Ducas, Inc.
Agency—J. Walter Thompson Co.	Librascope, Inc. .... 6
Allegheny Ludlum Steel Corp. .... 70	Agency—Compton Adv., Inc.
Agency—W. S. Walker Adv., Inc.	Linde Co., Div. of
Allison Div., General Motors Corp. .... 49	Union Carbide Corp. .... 42
Agency—Kudner Agency, Inc.	Agency—J. M. Mathes, Inc.
American Beryllium Co., a Div.-	Ling Electronics, Inc. .... 88
Visioneering Co., Inc. .... 62	Agency—John Ramsay Co., Adv.
Agency—Gilmore-Rice Adv.	Marquardt Aircraft Co. .... 44, 45
American Bosch Arma Corp.,	Agency—Grant Adv., Inc.
Arma Div. .... 28	Millipore Filter Corp. .... 30
Agency—Doyle, Kitchen & McCormick, Inc.	Agency—Walter B. Snow & Staff, Inc.
American Pipe Steel Corp. .... 24	Missiles & Space Systems Div.,
Agency—Thomas M. Cavanagh, Inc., Adv.	United Aircraft Corp. .... 66
American Welding & Mfg. Co. .... 4	Agency—G. F. Sweet & Co., Inc.
Agency—The Bayless-Kerr Co.	North American Aviation, Inc.
Baldwin Piano Co., The .... 57	Autonetics Div. .... 78
Agency—The Keeler & Stites Co.	Missile Development Div. .... 31
Beckman & Whitley, Inc. .... 58	Agency—Batten, Barton, Durstine &
Agency—Gerth, Brown, Clark & Eikus, Inc.	Osborn, Inc.
Behlman Engineering Co. .... 24	Pacific Automation Products, Inc. .... 27
Agency—Jack Packard Adv.	Agency—Anderson-McConnell, Adv.
Bendix Aviation Corp.	Agency, Inc.
Bendix Products Div. .... 41	Pesco Products Div.,
Agency—MacManus, John & Adams, Inc.	Borg-Warner Corp. .... 81
K C Div. .... 26	Agency—The McCarty Co.
Agency—Selders-Jones-Covington, Inc.	Precision Lapping Co., Inc. .... 24
Scintilla Div. .... 53	Agency—Herbert Lindauer Assoc.
Agency—MacManus, John & Adams, Inc.	Radio Corp. of America .... 76
Blockson & Co., Hurst & McDonald, Inc.	Agency—Al Paul Lefton Co., Inc.
Boeing Airplane Co. .... 13	Robertshaw-Fulton Controls Co.,
Agency—Calkins & Holden, Inc.	Aeronautical & Instrument Div. .... 33
Brunswick-Balke-Collender Co., The ... 10	Agency—Leland Oliver Co.
Agency—McCann-Erickson, Inc.	Rockwell Standard Corp.,
Bulow Electric Co. .... 50	Transmission & Axle Div. .... 56
Agency—Frederick Associates Adv. Service	Agency—MacFarland, Aveyard & Co.
Callery Chemical Co. .... 82	Servomechanisms, Inc. .... 2
Agency—Ketchum, MacLeod & Grove, Inc.	Agency—Sanger-Funnell, Inc.
Consolidated Electrodynamics Corp. .... 80	Simmonds Aerocessories, Inc. .... 32
Agency—Hixson & Jorgensen, Inc.	Agency—Burke Dowling Adams, Inc.
CONVAIR, a Div. of	Statham Instruments, Inc. .... 34
General Dynamics Corp. .... 61	Agency—Getz & Sandborg, Inc.
Agency—Buchanan & Co., Inc.	Stromberg-Carlson Co., Div.
Craig Systems, Inc. .... 60	General Dynamics Corp. .... 51
Agency—Larcom Randall Adv., Inc.	Agency—The Rumrill Co., Inc.
Cutler-Hammer, Inc. .... 64	Telecomputing Corp. .... 40
Agency—Kirkgasser-Drew	Agency—Anderson-McConnell Adv.
Douglas Aircraft Co., Inc. .... 54	Agency, Inc.
Agency—J. Walter Thompson Co.	Teleflex, Inc. .... 81
Eastern Industries, Inc. .... 87	Agency—John T. Hall & Co.
Agency—Remsen Adv. Agency, Inc.	Templet Industries, Inc. .... 43
Electrical Engineering & Mfg. Corp. .... 8	Agency—Richard & Gunther, Inc.
Agency—West-Marquis, Inc.	Townsend Co., Cherry Rivet Div. .... 79
Ex-Cell-O Corp., Aircraft Div. .... 20	Agency—Bond & Starr, Inc.
Agency—Holden, Chapin, LaRue, Inc.	Vickers, Inc., Div., Sperry Rand Corp.
Fansteel Metallurgical Corp. .... 36	Agency—Witte & Burden.
Agency—Symonds, MacKenzie & Co., Inc.	Washington Steel Corp. .... 65
Flexonics Corp. .... 47	Agency—Cabbot & Coffman, Inc., Adv.
Agency—Russell T. Gray, Inc.	Westinghouse Electric Corp.,
General Electric Co. .... 59	Air Arm Div. .... 25
Agency—G. M. Basford Co.	Agency—Fuller & Smith & Ross, Inc.
General Electric Co. .... 37	White Aircraft Corp. .... 26
Agency—de Garmo, Inc.	Agency—The Taylor & Greenough Co.
Goodyear Tire & Rubber Co.,	
Aviation Products .... 3	
Agency—Kudner Agency, Inc.	
Gulton Industries, Inc. .... 75, 77	
Agency—Marsteller, Rickard, Gebhardt &	
Reed, Inc.	

## CLASSIFIED

Sales Engineer and Manufacturers Representative, covering Pacific Northwest, including Washington, Oregon, Idaho, Alaska, seeks additional principals in Missiles, Aircraft, Nautical, Atomic products. Only manufacturers with adequate facilities need apply. I extend my hearty welcome to your organization to investigate with me the possibilities of your participation in a mutually remunerative venture. Box 119, Missiles & Rockets Magazine, 1001 Vermont Ave., N. W., Washington, D. C.

## VIBRATION MACHINES WANTED

FOR IMMEDIATE OR EARLY DELIVERY

—NEW OR USED—

ANY OF THESE MB MODELS:

C 25 H C 25 HB C 70

WIRE OR WRITE: BOX 120

MISSILES & ROCKETS  
8929 WILSHIRE BOULEVARD  
BEVERLY HILLS, CALIFORNIA

## EMPLOYMENT SECTION

General Electric Co. .... 84, 85  
Agency—Deutsch & Shea, Inc.

## CLASSIFIED

# ENGINEERS

## Immediate Openings

Expanding research and production programs at our Boulder, Colo. and Wichita, Kans. facilities have created urgent need for qualified engineers with 3 to 7 years experience in these fields:

AERONAUTICAL DESIGN  
AERODYNAMICS  
STRESS ENGINEERING  
STRUCTURES ENGINEERING  
COMPUTER ENGINEERING  
RESEARCH ENGINEERING  
CRYOGENIC DESIGN  
HEAT TRANSFER  
FLUID SYSTEM DESIGN  
ELECTRONIC SYSTEMS

Send brief resume to C. B. Jones, Employment Manager.

## BEECH AIRCRAFT CORPORATION

Wichita 1, Kansas

# ENGINEERS

for a

## U. S. GOV'T AGENCY

in

## WASHINGTON, D. C.

AERONAUTICAL — \$8,810-\$10,130 — Three to five years experience with airplane manufacturers; one who has planned or supervised installations of jet engines. Will also consider jet engine design experience. Position involves analysis of research and development.

MISSILE ENGINEER—Approx. \$11,000—Experience in general planning and execution of guided missile flight test programs including requirements for facilities, communication, instrumentation, data reduction, number and frequency of tests.

RESEARCH ENGINEER — \$10,000-\$11,000—Experience in the general planning and development of air defense missiles, ballistic missiles or space research programs.

Please send resume to:

P. O. Box 7118 Apex Station  
Washington, D. C.



**ENGINEERS, SCIENTISTS:** Specific Experimental Data have now been declassified from which you can gauge the breadth of the opportunities for original work open to you in the pioneering field of nuclear power for aircraft. This information is made available from a paper prepared for the recent Geneva Conference on Peaceful Uses of Atomic Energy, by Mr. D. R. Shoultz, General Manager, Aircraft Nuclear Propulsion Dept. of General Electric, Cincinnati, Ohio.

Test Assembly for HTRE No. 1 to the right is on its way to test area on a flat car, drawn by a shielded locomotive. Test area control center itself is underground for safety considerations. During test period, the *Direct Cycle Nuclear Turbojet System* was shut down between operating phases and the Test Assembly returned to the "Hot Shop" (a chamber with 7 ft. thick concrete walls and 6 ft. thick windows) where remote handling equipment, designed for this program, disassembled components for the inspection or replacement of parts.

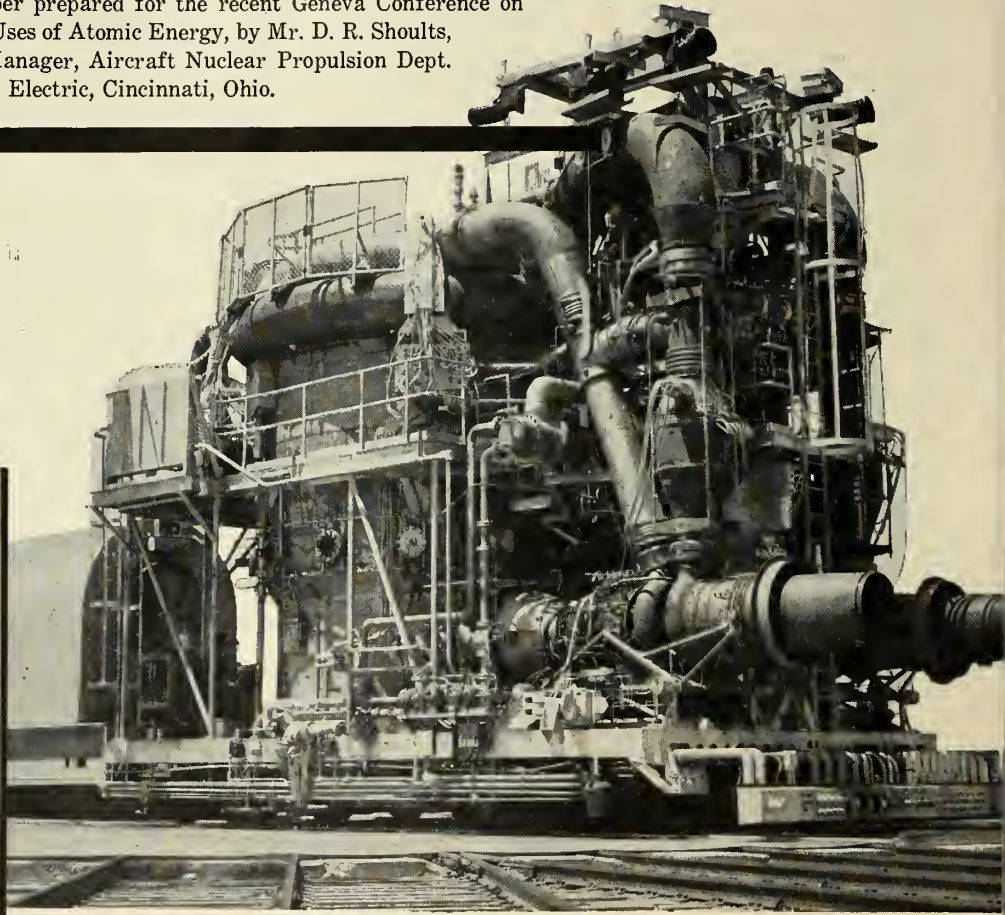

# FIRST PHOTOGRAPHS, DIAGRAMS AND TECHNICAL DATA RELEASED ON HISTORIC TESTS PROVING FEASIBILITY OF DIRECT CYCLE NUCLEAR TURBOJET SYSTEM FOR AIRCRAFT



# Successful Heat Transfer Reactor Experiment No. 1 Basis of Present Advanced Development Stage of Aircraft Nuclear Power Plant

HTRE No. 1 marked the first time that all the components of a combined reactor and jet engine power plant were assembled and operated.

The system was developed and produced by General Electric engineers and scientists at the Aircraft Nuclear Propulsion Department, Cincinnati, Ohio, under dual contract with the U.S. Air Force and the U.S. Atomic Energy Commission. The tests were conducted at the National Reactor Test Station in Idaho Falls, Idaho, during the period January 1956-January 1957.

"These tests," Mr. Shoultz writes, "were of great significance in meeting the objective of developing a useful aircraft nuclear propulsion system. HTRE No. 1 proved conclusively the operability of the system and the predictability of its performance."

The Test Assembly for the experiment consisted of an air-cooled, metallic-fuel-element, water-moderated reactor operating a modified J47 turbojet engine designated X39. A photograph of this assembly is reproduced at the left; schematic diagram below shows a simplified version of the air flow path through the system.

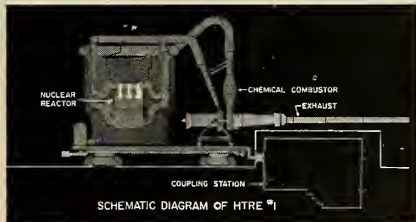

Test Assembly utilizes the direct air cycle to which propulsive thrust is provided by sending atmospheric air from the compressor (compressed to 5 times the intake pressure) directly through reactor, into the turbine, and out exhaust nozzle.

The reactor core structure consists of a cylindrical water vessel penetrated by air tubes. The shield plug structure and the heavy gamma ray shielding are of stainless steel. Moderator water is used for neutron shielding in shield plug.

The power plant is started on chemical fuel alone, with compressor air passing through the cold reactor. As the reactor power increases, the chemical fuel flow is decreased. When nuclear power is sufficient for self-sustaining operation, chemical fuel is cut off.

Throughout the tests, operation was stable during the transition from chemical to nuclear power and the reactor was responsive to both manual and automatic control. Combined operating time during test period totaled 258 hours. A chart showing total energy produced in test period is reproduced below.

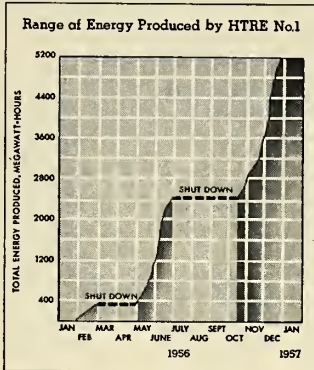

## Confirmation of Design Concept of Direct Cycle Nuclear Turbojet System Obtained

Extensive operation at full nuclear power was recorded without failure or significant leakage of radioactive material to the airstream. Proof was obtained that overheating portions of the reactor would not lead to local flow starvation and progressive overheating.

Much of the apparatus illustrated was provided for developmental convenience and would not be used in an actual system for aircraft. The shield, for example, is extra-heavy to allow external contact maintenance during shut-down. In an aircraft installation the shield would be much lighter and the engine would be coupled more closely to the reactor-shield assembly. A diagram of a potential configuration for a Direct Cycle Nuclear Turbojet System for airframe application is shown below.

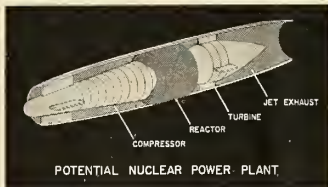

## 2nd and 3rd Generation Nuclear Power Plants for Aircraft Now Under Development

Research and development has proceeded at an accelerated pace at General Electric, since the epochal results of HTRE No. 1 in early '57.

The great challenge of the aircraft nuclear propulsion project is that this type of system requires generation of large amounts of heat from a nuclear reactor of very small volume. Also, all items comprising the power plant must be provided within very stringent weight limitations.

Intensive work has been—and is—under way in areas of reactor design, shield design, and the development of new materials to withstand extreme temperatures and neutron bombardment, as well as new methods of fabricating these materials.

While much progress has been made, many problems must still be solved before the first high performance aircraft flies on nuclear power.

### ENGINEERS and SCIENTISTS:

If you are interested in joining the professional staff now working in breakthrough areas on the Aircraft Nuclear Propulsion Program of General Electric—and have the necessary qualifications for any of the technical fields described below—your inquiry will be welcomed.

A majority of these openings do NOT require previous nuclear experience.

Openings for METALLURGISTS; CERAMISTS; MATHEMATICIANS; MECHANICAL, ELECTRICAL, AERONAUTICAL AND CHEMICAL ENGINEERS; NUCLEAR AND SOLID STATE PHYSICISTS; PHYSICAL CHEMISTS to work in the following areas:

Applications Engineering • Product Design • Mechanical Development • Technical Design • Nuclear Development • Reactor Analysis • Thermodynamics • Controls and Instrumentation • Applied Mathematics • Process Engineering • Project Engineering • Materials Development • Fuel Element Research • Shielding Development • Applied Materials Research—Applied Ceramics Research.

Write in confidence, including salary requirements: to Mr. P. W. Christos, Room 43-WT

AIRCRAFT NUCLEAR PROPULSION DEPARTMENT

# GENERAL ELECTRIC

P.O. Box 132, CINCINNATI 15, OHIO

# Let's Do Something About Education, Now!

If there has been any doubt as to the seriousness of the shortage of trained U.S. technical personnel, a study of two articles in *m/r* (Oct. 6 and Oct. 27) should remove further questions.

When it becomes apparent that companies are forced into actual purchase of technical know-how in an ever-rising market, it's time to do something.

This shortage of trained people isn't new. It has been with us—and has been recognized by technical societies and the educators—since the end of World War II. A tremendous flood of verbiage has flowed across the pages of the business and general press concerning this subject. More words have filled the ears of listeners at endless conventions and meetings.

The government, at the past session of Congress, took some action—but not very much. And little else has been done where it counts.

The eventual remedy, of course, is at the level of the technical schools—and certainly every encouragement should be given to them to train new people. But closing the gap by this means is too slow a process—it takes at least five years of schooling and experience to train a college-age youngster to a point where he can be called well grounded technically.

A remedy is needed, and it is needed right now.

And there is a way to do it, right now.

That way is for industry—collectively and individually—to take hold and do the job. It is industry that needs the people, and industry which must set the standards of training.

Many industrial organizations have made stabs at the problem on an individual basis, with in-training programs, small grants to universities, scholarships, and the like.

But it is time for industry to work together on this—through existing national organizations like the U.S. Chamber of Commerce, the National Association of Manufacturers, the Electronics Industries Association, and Aircraft Industries Association.

A program might be worked out this way:

The various industry groups could appoint a central committee, representing all of them.

This committee could first determine what industry's needs will be for technically-trained people over a period of many years.

It could then break down the overall need to specifics—how many chemists, how many electrical engineers, how many physicists.

Next step could be a census of how many of these people are now available, or will become available through graduation or experience, within the specified period. This census should be broken down to include age and experience, so that some measure can be taken of the natural attrition that will occur.

One further breakdown should be made: How many of the needed people must be college-trained with degrees, and how many can be trained in technical schools or on-the-job training courses for less technical work.

And while industry is at it, it might make a further census of another large reservoir of skill—the ranks of men and women who have been retired, but whose knowledge might still be tapped.

With this kind of information in hand, a united industry front could attack the problem several ways:

- It could aid the schools with direct grants of money.
- It could aid the schools by lending some of its own top personnel to help hard-pressed teaching staffs.
- It could provide intensive and better planned on-the-job training programs, centrally supervised, and if need be, following a broad general teaching plan.
- It could make provision for re-training, or at least refresher training, of men already on its pay-rolls.
- It could work with labor organizations to spread the training further down the ranks, so that another potential reservoir of replacements could begin training.
- It could work with the military in these programs, so that military and civilian training would be along the same lines, and civilian and military personnel could understand mutual problems.
- It could advise government agencies in their efforts to help.

Only by such a concerted effort can the U.S. hope to provide enough of the right people at the right time to keep our missile and space programs—as well as other endeavors based on science—rolling and producing results.



# SUBSCRIBER SERVICE

## missiles and rockets

For additional information about any product or service advertised or mentioned in the editorial pages of this issue of Missiles and Rockets:

Use the attached prepaid reply cards. Circle numbers shown on the reply card that correspond with numbers appearing beneath items described. If no circle number accompanies the article or advertisement, give page number (and advertiser's name) on line provided at bottom of the card.

Your requests for information will be forwarded promptly to the companies concerned.

### NEW PRODUCT BRIEFS

**COMPRESSORS**—Two "pint-size" portable compressor assemblies for ground service of aircraft, missile and other equipment and systems have been announced by The Cornelius Co. These complete pneumatic service carts are extremely portable and light weight. They can be easily handled by one man. The manufacturer reports the outstanding feature of the new compressor assemblies is their light weight—about one-tenth that of other larger types of compressor assemblies. The capacities of the Cornelius compressor assemblies considered to be ample for all commercial and commercial type airplane applications, with the exception of compressed air for use with fuel air starter motors as used on the largest aircraft. Circle No. 233 on Subscriber Service Card.

**TAPE TEST SET**—A new, completely integrated electronic test set comprised of a group of high-quality basic test instruments is now available from Consolidated Electrodynamics Corp. Known as the Data-Tape Type 23-203 Test Set, the new unit is designed principally to carry out fast, accurate adjustments and measurements on CEC's 5-752 Magnetic Recorder/Reproducer. Such operations as frequency response measurements of record and reproduce amplifier, measurement and adjustment of netic-heat record and bias current amplifier input/output levels, calibration of FM record amplifiers, set-up of DM recording mode, and equalization tests of analog reproduce amplifiers are all accomplished with the new

Circle No. 236 on Subscriber Service Card.

**MINIATURE MOTOR**. The Electro Production Division of Western Gear Corp. has a new miniature motor, Model 2PPI, which runs at 1/100 HP at 11,000 RPM. It has been qualified to MIL-M-8609 specification. The 26.5 volt D. C. motor is 1.5 inches in diameter, 1.9" long and weighs 0.5 oz. Life is 500 hours without change of brushes.

Circle No. 238 on Subscriber Service Card.

**TEMPERATURE SENSOR**. Available immediately from stock in tape-on or self-adhering models, Minco's Thermal-Ribbon by Minco Products, Inc. provides sensing of temperature for monitoring or control. Measuring 3/8 inch by 2 inches by .020 in., the Thermal-Ribbon is thin and flexible for use on flat, curved, or irregular surfaces. It can also be built into equipment. Resistance is 676 ohms per degree C. at 25°C. Thermal time constant is as small as 1/2 second—depending on installation.

Circle No. 237 on Subscriber Service Card.

**TRANSISTORS**. Silicon PNP transistors for 1 to 4 megacycle operation in severe environments have been established in production at Sperry Semiconductor Division, Sperry Rand Corp. Four new alloy junction transistors incorporate "micro-control," a new Sperry design feature that holds input resistance in all units to a uniform value. Selection problems are reduced by the uniform 35-ohm value, which is one-third the input resistance previously realized in megacycle transistors. Collector voltages of the new units have been made up to 3 1/2 times higher to extend use of these transistors to gate circuits, amplifiers, regulators and converters for missiles and controls where higher collector voltage and gain are desired.

Circle No. 232 on Subscriber Service Card.

**STEPPER MOTOR**. The Instrument Div. of American Electronics, Inc. has a Size 11 Stepper Motor, Model PM112A3, a permanent magnet rotor bi-directional stepper motor for precision rotary motion without reciprocating parts. Stepping rate is 90 pulses-per-second in random pulse direction. The unit is basically bi-directional, furnishing the desired degree of rotor step for each pulse. The Stepper Motor Model PM-112a3 can be supplied with internal logic circuitry—either mechanical or solid state, for adaptation to existing systems and circuitry.

Circle No. 234 on Subscriber Service Card.

**MISSILES AND  
ROCKETS**  
**NOVEMBER 17, 1958**  
Expires Three Weeks  
After Above Date

NAME \_\_\_\_\_ TITLE/POSITION \_\_\_\_\_  
 COMPANY \_\_\_\_\_  
 Product Mfg./Service Offered \_\_\_\_\_  
 ADDRESS \_\_\_\_\_  
 CITY \_\_\_\_\_ ZONE \_\_\_\_\_ STATE \_\_\_\_\_

Card cannot be processed unless all information is given.  
Please limit requests to ten items.

CIRCLE NUMBERS BELOW FOR INFORMATION ON PRODUCTS, LITERATURE OR ADVERTISEMENTS

• Advertisements	1	2	3	4	5	6	7	8	9	10	11	12	13	14	15	16	17	18	19	20	21	22	23	24	25
• Missiles Literature	26	27	28	29	30	31	32	33	34	35	36	37	38	39	40	41	42	43	44	45	46	47	48	49	50
• New Missile Products	51	52	53	54	55	56	57	58	59	60	61	62	63	64	65	66	67	68	69	70	71	72	73	74	75
	76	77	78	79	80	81	82	83	84	85	86	87	88	89	90	91	92	93	94	95	96	97	98	99	100
	101	102	103	104	105	106	107	108	109	110	111	112	113	114	115	116	117	118	119	120	121	122	123	124	125
	126	127	128	129	130	131	132	133	134	135	136	137	138	139	140	141	142	143	144	145	146	147	148	149	150
	151	152	153	154	155	156	157	158	159	160	161	162	163	164	165	166	167	168	169	170	171	172	173	174	175
	200	201	202	203	204	205	206	207	208	209	210	211	212	213	214	215	216	217	218	219	220	221	222	223	224



**BUSINESS REPLY CARD**  
 First Class Permit No. 2455-R (Sec. 510 P.L.&R.) Washington, D.C.

**MISSILES and ROCKETS**  
 17 EAST 48th STREET  
 NEW YORK 17, N.Y.



SUBSCRIBER SERVICE DEPT.

# MISSILE LITERATURE

**BULLETINS.** Miles Samuelson, Inc. has recently established a Technical Information Exchange and has issued a series of bulletins covering various aspects of military contract work, principally in the publications field. The first two bulletins, "The Facilities Brochure" and "Space Age Art," are available. A third, "The Proposal," will be available shortly.

Circle No. 200 on Subscriber Service Card.

**SERVO AMPLIFIER.** Magnetic Amplifiers, Inc. has made available a four-page brochure describing the company's new line of Transi-Mag Servo Amplifiers with power ratings to 16 Watts. Complete specifications data, circuit theory and applications for missile use are provided.

Circle No. 201 on Subscriber Service Card.

**ANALOG-TO-DIGITAL CONVERTER DATA.** A four-page illustrated brochure providing design information on a new device for shaft analog-to-digital conversion is offered by Data Instruments Div. of Telecomputing Corp. The brochure shows typical pulse output waveforms and is illustrated with photographs and drawings of the equipment and functions. Applications of the device are described in terms of specific equipment requiring measurement of shaft position and rotation direction.

Circle No. 202 on Subscriber Service Card.

**VIBRATION TESTING SYSTEMS.** Three bulletins are now available for use by aviation, missile, and rocket design and test engineers engaged in precise vibration analysis. These brochures, offered by MB Manufacturing Co., New Haven, Conn., give detailed specifications of each of the components of the system as well as system performance. For convenience, the company's most widely used line of vibration testing systems has been divided into three categories, 1200 to 2500 lbs., 1750 to 5000, and 7000 to 25,000 lbs., based upon the total pounds of output force available.

Circle No. 203 on Subscriber Service Card.

**FLOW TRANSDUCER.** The Ramapo Instrument Co., Inc., announces the publication of a new four-page brochure on the Mark V Flow Transducer. The Mark V, specifically designed for the measurement of single or bidirectional flow, is fully covered. Such details as range, pressure, temperature, frequency response, line sizes and materials are covered in a General Specifications section; the Electrical Information section covers input, output, resistance.

Circle No. 204 on Subscriber Service Card.

**WALK-IN CHAMBER.** A six-page brochure is offered by Conrad, Inc., showing walk-in environmental chambers temperature, altitude, and humidity. The brochure describes complete missile facilities and components testing unit. It also lists field application offices.

Circle No. 205 on Subscriber Service Card.

**SIDE MOUNTED CONNECTORS.** Illustrated bulletin giving specifications, outline dimensions and general information on new Series "G" miniature connectors, is available from Electro Sales Div. DeJUR-AMSCO Corp. The unusually small, rectangular connectors having the added feature of space-saving side mounting are available in 2, and 4 contact arrangements.

Circle No. 206 on Subscriber Service Card.

**POLARIZED RELAYS.** A new 8-page bulletin recently released by Barber-Colman Co., offers a series control system suggestions, and describes some of many possible applications of the polarized relay. Suggested uses for the company's Micropositioner relay are listed under the headings: General Control Instrumentation, Servomechanisms and Transistor Circuits. All applications are well illustrated with helpful wiring diagrams and photographs.

Circle No. 207 on Subscriber Service Card.

**TRANSFORMERS.** Minitran Corp.'s latest catalog describes transformers a related magnetic components design and manufactured by the company's electronic instrumentation application Transformers covered range in weight from 0.45 to 0.5 lbs.

Circle No. 208 on Subscriber Service Card.

**MOTORS.** Electric Indicator Co., Inc. manufacturers of instrument-type motors and generators, has just published a completely-revised edition of their catalog #El-4 on Elinco synchronous Motors. It includes detailed data on over 20 synchronous motor designs, many of them only recently developed, and offers technical information on the theory and application of all types of synchronous motors.

Circle No. 209 on Subscriber Service Card.

**SERVO VALVES.** Catalog 220, just published by Moog Valve Co. Inc., describes the firm's line of flow-control servovalves for use in a wide range of missile and nuclear applications. Detailed information on valves in this series is accompanied by curves on normal flow gain tolerance, load flow-pressure characteristics, typical frequency response.

Circle No. 210 on Subscriber Service Card.

NO POSTAGE  
NECESSARY  
IF MAILED  
IN THE  
UNITED  
STATES

First Class Permit No. 2455-R (Sec. 510 P.L.R.) Washington, D.C.

## BUSINESS REPLY CARD

### MISSILES and ROCKETS

17 EAST 48th STREET

NEW YORK 17, N.Y.

SUBSCRIBER SERVICE DEPT.

POSTAGE  
WILL BE  
PAID BY  
ADDRESSEE

NAME \_\_\_\_\_  
TITLE/POSITION \_\_\_\_\_  
COMPANY \_\_\_\_\_  
Product Mfg./Service Offered \_\_\_\_\_  
ADDRESS \_\_\_\_\_  
CITY \_\_\_\_\_ ZONE \_\_\_\_\_ STATE \_\_\_\_\_

Card cannot be processed unless all information is given.  
Please limit requests to ten items.

MISSILES AND ROCKETS  
NOVEMBER 17, 1958  
Expires Three Weeks After Above Date

- CIRCLE NUMBERS BELOW FOR INFORMATION ON PRODUCTS, LITERATURE OR ADVERTISEMENTS
- 1 Advertisements
  - 2
  - 3
  - 4
  - 5
  - 6
  - 7
  - 8
  - 9
  - 10
  - 11
  - 12
  - 13
  - 14
  - 15
  - 16
  - 17
  - 18
  - 19
  - 20
  - 21
  - 22
  - 23
  - 24
  - 25
  - 26
  - 27
  - 28
  - 29
  - 30
  - 31
  - 32
  - 33
  - 34
  - 35
  - 36
  - 37
  - 38
  - 39
  - 40
  - 41
  - 42
  - 43
  - 44
  - 45
  - 46
  - 47
  - 48
  - 49
  - 50
  - 51
  - 52
  - 53
  - 54
  - 55
  - 56
  - 57
  - 58
  - 59
  - 60
  - 61
  - 62
  - 63
  - 64
  - 65
  - 66
  - 67
  - 68
  - 69
  - 70
  - 71
  - 72
  - 73
  - 74
  - 75
  - 76
  - 77
  - 78
  - 79
  - 80
  - 81
  - 82
  - 83
  - 84
  - 85
  - 86
  - 87
  - 88
  - 89
  - 90
  - 91
  - 92
  - 93
  - 94
  - 95
  - 96
  - 97
  - 98
  - 99
  - 100
  - 101
  - 102
  - 103
  - 104
  - 105
  - 106
  - 107
  - 108
  - 109
  - 110
  - 111
  - 112
  - 113
  - 114
  - 115
  - 116
  - 117
  - 118
  - 119
  - 120
  - 121
  - 122
  - 123
  - 124
  - 125
  - 126
  - 127
  - 128
  - 129
  - 130
  - 131
  - 132
  - 133
  - 134
  - 135
  - 136
  - 137
  - 138
  - 139
  - 140
  - 141
  - 142
  - 143
  - 144
  - 145
  - 146
  - 147
  - 148
  - 149
  - 150
  - 151
  - 152
  - 153
  - 154
  - 155
  - 156
  - 157
  - 158
  - 159
  - 160
  - 161
  - 162
  - 163
  - 164
  - 165
  - 166
  - 167
  - 168
  - 169
  - 170
  - 171
  - 172
  - 173
  - 174
  - 175

For Other Information Give Page Numbers:

- New Missile Products
- Missile Literature

200 201 202 203 204 205 206 207 208 209 210 211 212 213 214 215 216 217 218 219 220 221 222 223 224  
225 226 227 228 229 230 231 232 233 234 235 236 237 238 239 240 241 242 243 244 245 246 247 248 249  
250 251 252 253 254 255 256 257 258 259 260 261 262 263 264 265 266 267 268 269 270 271 272 273 274  
275 276 277 278 279 280 281 282 283 284 285 286 287 288 289 290 291 292 293 294 295 296 297 298 299



# POWER FOR MISSILE & AIRCRAFT HYDRAULIC SYSTEMS

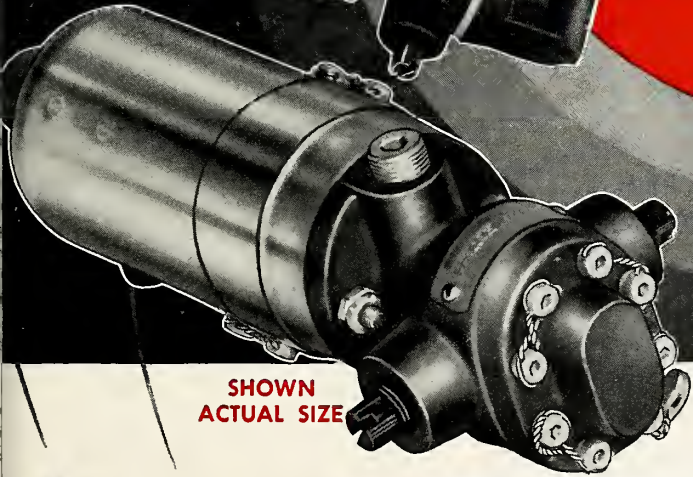
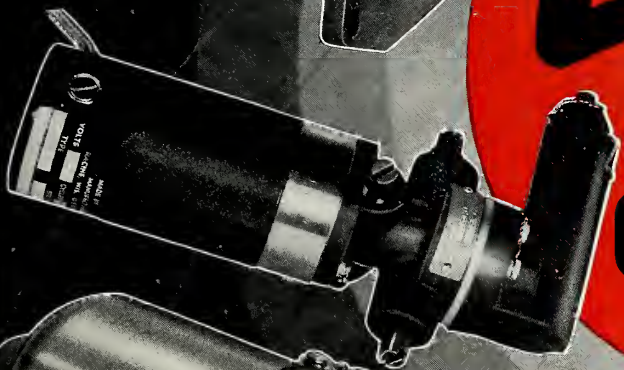

**SHOWN  
ACTUAL SIZE**

# **EASTERN** **HIGH SPEED GEAR PUMPS**

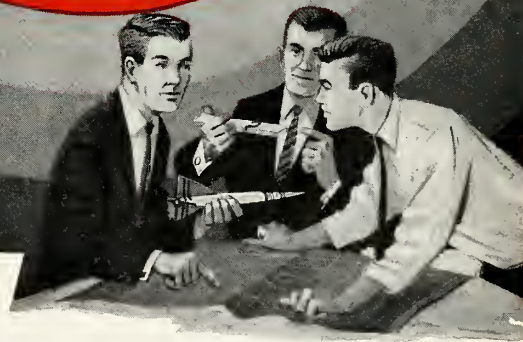

**Eastern Aviation Hydraulic Pumps set new standards for performance, yet are the smallest, most lightweight ever made.**

By meeting customer requirements and government specifications with precise detail, Eastern Pumps give reliable long-term service.

Hundreds of models, close-coupled to electric motors with speeds to 24,000 RPM, can be furnished for your special systems. You gain the advantage of economical mass-produced components custom-engineered into whatever configuration is needed. Performance is from .015 to 1.5 GPM, 0 to 3000 PSIG, with theoretical displacements from .0021 to .0419 cubic inches per revolution. A variety of bearing combinations handle different types of fluid and operating pressures.

Missile and aircraft system engineers have discovered Eastern Pumps do the same job as units that use greater space and weigh far more. Applications have included circulating coolant in bomber guidance system, providing hydraulic power for ground control of jet, charging accumulator in an in-flight refueling system, furnishing an APU system with power to a missile, and countless others. For your next project, contact Eastern for creative engineering help that really helps.

*Write for NEW Aviation Bulletin 350 describing the above units and larger-capacity pumps.*

## **EASTERN INDUSTRIES, INCORPORATED**

100 Skiff Street • Hamden 14, Conn.      West Coast Office: 1608 Centinela Avenue • Inglewood 3, California

Circle No. 2 on Subscriber Service Card.





*prescription for a successful orbit*  
**"SHAKE WELL BEFORE USING"**



**Ling vibration testing proves reliability of Explorer satellites before launching**

THE SUCCESS STORY of the Explorer Satellites actually began long before the countdown. Every piece and component was vibration "flown" again and again through endless testing and checkout procedures.

In fact, the *fully assembled* Explorer Satellites now in orbit were given a thorough vibration testing at Caltech's Jet Propulsion Laboratory in Pasadena, California.

The actual conditions of space flight were computed in a synthesized program, and, using Ling Electronic power generators and advanced techniques, space flight conditions were duplicated in the laboratory!

The ability to develop complex test equipment for new and challenging areas such as this is one of the reasons Ling is recognized as a leader in high power electronics.

Because of the conditions encountered in the flight to space, a random wave program was the only vibration test considered realistic enough for the Explorers. Tests at JPL included random noise band limited to 20-1500 cps with an amplitude as great as 25 G rms perpendicular to the thrust axis. Shown on the shaker table is an Explorer instrumentation package.

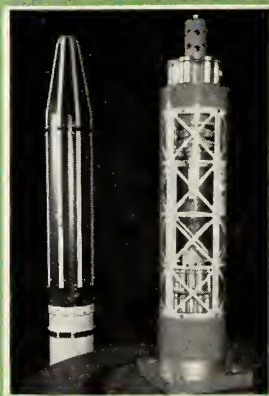

**LING** ELECTRONICS INC.

9937 West Jefferson Blvd., Culver City, California • Telephone: TEXAS 0-7711

Circle No. 3 on Subscriber Service Card.