

N.A. Rynin

NASA
TT
F-640
v.1/#3
c.1

INTERPLANETARY FLIGHT AND COMMUNICATION

Volume I, No. 3

**LOAN COPY: RE
AFWL (D
KIRTLAND AFB**



RADIANT ENERGY
Science Fiction and Scientific Projects

TRANSLATED FROM RUSSIAN

Published for the National Aeronautics and Space Administration
and the National Science Foundation, Washington, D.C.
by the Israel Program for Scientific Translations

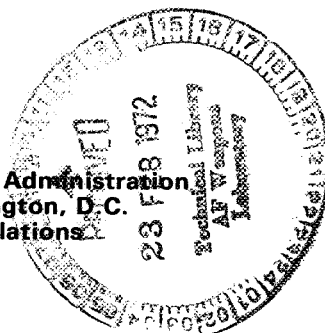

TECH LIBRARY KAFB, NM

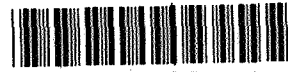

0069214

N. A. Rynin

INTERPLANETARY FLIGHT AND COMMUNICATION

(Mezhplanetnye soobshcheniya)

Volume I, No. 3

RADIANT ENERGY

Science Fiction and Scientific Projects

(Luchistaya energiya v fantazyakh
romanistov i v proektakh uchenykh)

Leningrad 1931

Translated from Russian

Israel Program for Scientific Translations
Jerusalem 1971

TT 70-50113
NASA TT F-642

Published Pursuant to an Agreement with
THE NATIONAL AERONAUTICS AND SPACE ADMINISTRATION
and
THE NATIONAL SCIENCE FOUNDATION, WASHINGTON, D. C.

Copyright © 1971
Israel Program for Scientific Translations Ltd.
IPST Cat. No. 5814

Translated by IPST Staff

Printed in Jerusalem by Keter Press

Available from the
U. S. DEPARTMENT OF COMMERCE
National Technical Information Service
Springfield, Va. 22151

Table of Contents

	Page
Preface	iv
Introduction	v
CHAPTER I. Radiant Energy in Science Fiction	1
CHAPTER II. Radiant Energy in Scientific Projects	17
CHAPTER III. Interplanetary Signals and Communication in Science	41
1. Optical communication by means of telescopes	41
2. Communication by means of light rays	50
3. Radio signals	62
4. Radio telescopes	65
5. Telephone communication	68
CHAPTER IV. Interplanetary Signals in Scientific Projects	74
CHAPTER V. Changing the Motion of Planets by Artificial Means in Science Fiction	91
1. Changing the motion of the Earth	91
2. Changing the motion of other planets	97
3. Creation of new planets	110
CHAPTER VI. When Will Man Reach Other Planets?	112
1. Struggle for existence and methods of solving this problem	112
2. Human reproduction rate	114
3. Existing and replenishable energy resources on Earth	116
4. The balance of energy on Earth and the imminent migration to other planets	129
The end of the world	131
Conclusion	133

PREFACE

This volume is the sixth in a series of books published separately by the author under the general title "Interplanetary Flight and Communication. The following five books have already appeared:

1. Dreams, Legends, and Early Fantasies.
2. Spacecraft in Science Fiction.
3. Rockets.
4. Theory of Rocket Propulsion.
5. Superaviation and Superartillery.

The seventh volume, "K. E. Tsiolkovskii, Life, Writings and Rockets," is being printed simultaneously with this book.

Two volumes put out by different publishing houses are ready to go to press:

9. Translation of Oberth's book "Wege zur Raumschiffahrt." (3rd edition.)

11. Bibliography on Interplanetary Communication.*

The remaining volumes are also ready for printing but for technical reasons it is not known just when they will appear.

8. Scientific Projects [later changed to Theory of Space Flight].

10. Elements of Astronomy as Applied to Interplanetary Communication.*

Any comments on the volumes already published should be addressed to the author, Nikolai Alekseevich Rynin, 37, Kolomenskaya ul., ap. 25, Leningrad.

Leningrad, November 1, 1930

* [These two volumes were ultimately published in Russian in combined form as the ninth volume of the series: "Astronavigation, Theory, Annals, Bibliography" together with an Index covering the whole series. The English translation appears under TT 70-50119.]

"The ether is filled with vibrations of different kinds
and with the movement of electrons."

K. Tsiolkovskii, "In Outer Space"

5 INTRODUCTION

The topic of interplanetary flight and communication has by now ceased to be the exclusive domain of science-fiction writers: it has developed into a legitimate subject for scientific and technical treatment. Hundreds of books and articles have been published, analyzing and dealing with various problems associated with the flight of man into outer space.

In my other books (see Preface), the reader will find descriptions of methods proposed by novelists for making manned interplanetary flights a reality. In addition to manned flights to other planets, we should also consider other ways of communication with extraterrestrial intelligences by transmitting our thoughts over large distances.

During the last two decades, the Great War and the pressure of scientific and technical progress has led to a number of important discoveries in the field of radiant energy and has also engendered various hypotheses, fantasies, and science-fiction stories describing various fictitious applications of rays of different kinds and the potential uses of new, as yet undiscovered, forms of radiant energy. These new rays of the future are variously described in the literature and in the daily press as death rays, destruction rays, lethal rays, and other fearsome names. They are effective over enormous distances and possess terrifying power, wreaking destruction to whole cities and psychic damage or even death to people. They also may be used for interplanetary communication or possibly harnessed to change the motion of planets.

The idea of new rays and new sources of energy in science fiction and in scientific projects stems, on the one hand, from the possible existence of still unknown forces in nature (both on Earth and in outer space) and, on the other, from the not unfounded fear that some time in the future the existing energy resources (including the energy that we receive from the Sun) will become insufficient to meet the growing needs of mankind.

The book will present the reader with the various ideas regarding the generation and the action of powerful new rays, mainly from science fiction. The last chapters attempt to summarize and explain the current status of science in relation to these subjects.

7 *Chapter I*

RADIANT ENERGY IN SCIENCE FICTION

This chapter will bring to the reader fascinating projects of science-fiction writers who tried to predict or to examine new types of radiant energy and methods of its transmission. Although usually science fiction precedes scientific projects, startling hypotheses of the scientists in the past years, however, on the question of cosmic rays and, particularly, the experiments and the works of Millikan, McLennan, Kalgorster, and others have proved that reality may exceed science fiction and that scientific research opens new perspectives for solving the problem of interplanetary communications by using cosmic rays as a source of energy for the interplanetary spacecraft of the future.

(7)



FIGURE 1. Wells' heat rays

Wells' heat rays

H. G. Wells, in his novel "The War of the Worlds," describes the invasion of England by Martians. They arrived from Mars in ten large projectiles. Upon leaving the projectiles, they built special metal tripods capable of walking on Earth. A heat ray emitted from the top of a tripod would destroy everything on its way.

This is how Wells describes this device:

"And this thing I saw! How can I describe it? A monstrous tripod, higher than many houses, striding over the young pine-trees, and smashing them aside in its career; a walking engine of glittering metal, striding now across the heather; articulate ropes of steel dangling from it, and the clattering tumult of its passage mingling with the riot of the thunder. A flash, and it came out vividly, heeling over one way with two feet in the air to vanish and reappear almost instantly as it seemed, with the next flash, a hundred yards nearer. Can you imagine a milking-stool tilted and bowled violently along the ground? That was the impression those instant flashes gave. But instead of a milking-stool imagine it a great body of machinery on a tripod stand. . .

"Seen nearer, the thing was incredibly strange, for it was no mere insensate machine driving on its way. Machine it was, with a ringing metallic pace, and long flexible glittering tentacles (one of which gripped a young pine-tree) swinging and rattling about its strange body. It picked its road as it went striding along, and the brazen hood that surmounted it moved to and fro with the inevitable suggestion of a head looking about it. Behind the main body was a huge thing of white metal like a gigantic fisherman's basket, and puffs of green smoke squirted out from the joints of the limbs. . .

"Their armoured bodies glittered in the sun. . . One on the extreme left, the remotest, that is, flourished a huge case high in the air, and the ghostly terrible Heat-Ray I had already seen on Friday night smote towards Chentsey, and struck the town.

"The scientists could not determine exactly what the Martians' lethal weapon consisted of. The majority believed that the Martians had succeeded in generating and concentrating invisible heat rays in an absolutely heat-impermeable chamber. These heat rays were reflected by a parabolic reflector as light waves are in a lighthouse, and the Martians in the head of the tripod probably transmitted the waves through some kind of biconvex lens, the focal point of which they could move backward or forward at will; they directed this at any object they wished to destroy. All objects onto which this ray was directed were destroyed by fire. Vegetable and animal tissues burned, lead and even glass melted to a completely liquefied state, steel became soft, and the water even of large water bodies (rivers, lakes, and seas) was instantly turned into steam."

9 Semenov's detonator

V. Semenov, in his fascinating novel, "Tsari vozdukha" (Emperors of the Air), describes a method of remote explosion by means of a "detonator."

The device operates thus: "Light, chemical, electric, and detonating rays are all related phenomena. It is enough to direct an appropriate ray

at any explosive, to pass through it a hypothetical ether wave of an appropriate wavelength, and it decomposes into the constituent elements and produces an explosion. A "detonator" device, emitting various wavelengths depending on the composition to be exploded, was built on this principle."

Hans Dominik's rays

The German novelist Hans Dominik, in his novel "The Death Rays," describes powerful rays of the future by means of which atoms disintegrate and tremendous interatomic energy is liberated. Figure 2 represents a scheme of the rays' operation. A is the generator of rays which propagate over thousands of kilometers and are focused at a definite point in space by means of a special inductor. The disintegration of air atoms begins at that point and energy is liberated (10 billion* hp from 1 cm³). This energy may cause an explosion (as is shown in Figure 2, where an airplane is blown up), or be transformed into magnetic or electric energy, etc.

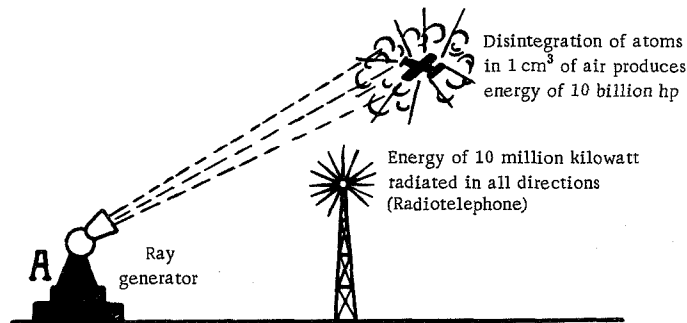

FIGURE 2. Hans Dominik's rays.

Moreover, Dominik proposes to create, by means of the same rays, an extremely powerful radiotelescope which by radiating energy of 10 million kilowatts in all directions transmits speech suppressing all other telephone conversations.

Utilization of atomic energy according to Hans Dominik

Hans Dominik in his novel "Der Brand der Cheopsyramide" describes three methods of generation of atomic energy and its utilization for military and peaceful purposes.

First method: Montgomery, an Englishman, invents an instrument which releases the energy of the atom. The inventor dies, however, before disclosing the secret of its operation. The Moorish government steals the

* [Billion - 10⁹, trillion - 10¹², quintillion - 10¹⁸.]

instrument from England and conceals it in Egypt, inside the Cheops Pyramid, where Ibn Ezer, a scientist, discovers the secret of its operation and at the order of the Caliph builds twelve similar instruments by means of which he hopes to conquer all of Europe.

Second method: "Riggers-Werke," a German firm, after numerous experiments, finally achieves some results. Its engineers raise the electric field strength to 5.2 million gauss. The atomic energy, however, is released explosively, destroying the plant.

Third method: Eisenecker, a German scientist, discovers a way of disintegrating atoms by means of condensed electricity, obtained statically. As a result, he obtains chemically pure gold and makes revolvers shooting bullets of condensed electricity that fly out as ball lightning destroying all on their way. Upon finding out about the designs of the Moorish Caliph, Eisenecker goes by helicopter to the peak of the Cheops Pyramid where he places one of his cartridges. Retreating to a safe distance from the pyramid, he detonates the cartridge by wireless energy transmission. The entire stone shell of the pyramid starts to burn and soon it is completely covered with fused vitreous mass. When it cools off, the original regular form of the pyramid is restored.

The instruments and the Caliph's inventor perish, and Eisenecker presents his invention to Germany for the advancement of her culture.

Rays decomposing matter into atoms

Gernsback, in his science-fiction story "Letters from Mars," describes rays used by the Martians to dig canals on their planet's surface. "Colossal towers, each a thousand feet tall, moved on wheels in a row along the axis of the future canal. From the top of each tower, wide beams of some bright-purple electro-chemical emanation were directed all around (Figure 3).

(11)

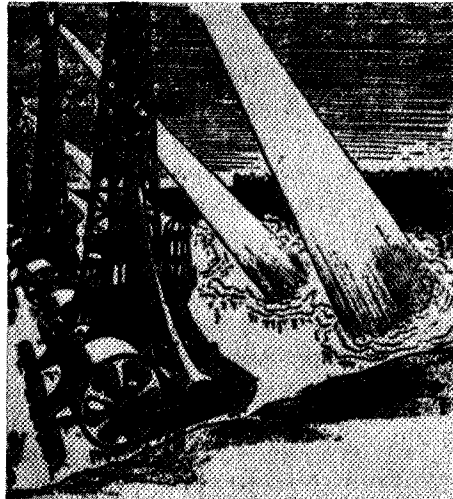

FIGURE 3. Gernsback's rays

These rays, disintegrating or rather melting atoms of any substance, were exceptionally powerful. The soil, hard rocks, sand, etc., literally melted under their effect. The ray itself, of course, is not hot; it does not have a high temperature but only transforms a substance into atoms, not penetrating deeply into the ground and forming a furrow no deeper than 8 meters.

Volkov's gun

M. Volkov, in his story "Bairo-Tun," describes a Martian coming to Earth in a jet-propelled missile. He carried a rifle which ejected products of disintegration of atoms. At a distance of 5 km, the shot destroyed everything in a radius of 600 meters. Moreover, by means of atom disintegration, the Martian could send anaesthetic rays to a distance affecting the nervous system of living beings and paralyzing their movements.

Valyusinskii's reverse explosions

V. Valyusinskii, in his novel "Pyat' bessmertnykh" (The Five Immortals), describes a new process of destruction brought to Earth by Selenites, the human colonists on the Moon. The concept of this process, called a reverse explosion, consists of the following: At the time of such an explosion, it is not the solid that turns into gases, as in an ordinary explosion, but gas is transformed into a solid body. Air elements are split to form a condensed substance, generally lead. This metal remains suspended in the form of a fine molecular dust. The entire space initially occupied by air becomes empty, since the volume of the metal is negligibly small. The interface between the resulting vacuum and the outside air absorbs all the light rays creating an impression of a black sphere. The surrounding matter rushes to the center. Here not only an atmospheric pressure plays an important role but also the eddy motions causing inductive disintegration of atoms and partial transmutation of matter.

If such a black sphere is created somewhere in the middle of an air squadron, all the aircraft will irresistibly be attracted to the center and will be flattened into a compact mass.

12 Lasswitz's magnetic rays

Kurd Lasswitz, in his novel "Auf zwei Planeten," describes the war of the Martians against Earth. The Martians passing in their craft over the Earth's armies emitted "magnetic rays" which attracted upwards all metal objects: guns, rifles, ammunition, etc. The collected objects were then jettisoned in another place on Earth and destroyed by other "nihilite rays."

Orlovskii's horror machine

Vladimir Orlovskii, in his science-fiction story "Mashina-uzhasa" (The Horror Machine), describes the invention of D. Elicott, an American, who discovered a way to transmit rays detonating explosives at a distance. This method consisted of the following: explosives have unstable molecules; they readily and instantaneously decompose into their constituents, producing an explosion. Since the forces restraining atoms in molecules and electrons in atoms are of electric origin, a sudden impact of an electromagnetic wave corresponding in wavelength to the vibrations of the atoms inside the molecule may trigger an explosion.

Elicott installed his machines on one of the islands at Pamlico Sound in North Carolina. The machines radiated electromagnetic waves obliquely upward. The waves were totally reflected from the upper rarefied layers of the atmosphere and were directed to a desired place on Earth. To generate the electromagnetic waves, he used "solar machines" in the form of huge mirror receivers, collecting the solar rays and transforming their energy into other forms.

The electromagnetic emitter had the shape of a hollow octahedral pyramid lying on one of its sides. It was made of aluminum and could be moved by means of a gear train. It was about 200 m long with a funnel 60 m wide. Two other similar pyramids were located nearby. The pyramids were coated on the inside surface with a reflective insulator layer. Directing the pyramids' funnels to different points on the Earth's surface, Elicott could detonate the explosives in these locations.

Elicott produced widespread destruction with his machines in America. Morev, a Russian scientist, discovered a method of paralyzing his activity. He sent a military detachment to attack Elicott, armed with ammunition containing plain black powder which did not explode in reaction to Elicott's rays. The men wore special clothing impervious to Elicott's other rays causing insanity and death. The story ends with Elicott's surrender and destruction of his island.

13 The ultra-blue rays of Dorgelès and Gignoux

The French novelists R. Dorgelès and R. Gignoux, in their novel "La Machine à finir la guerre," describe new "ultra-blue rays" which can detonate all explosives at a distance of 100 km. These rays are generated in the following way: several electric machines of 3,000 hp each feed current to tubes filled with mercury vapors. The vapors are then transformed, producing molecular bombardment; the vapors are transmitted through perfectly transparent molten quartz tubes. The rays are concentrated in a projector 25 m in diameter and aimed at the target.

Desberry's blue rays

The German writer L. Desberry, in his novel "Der blaue Strahl," describes how his hero, John Gay, a chemist, chemically liberates electrons from matter and constructs an apparatus which concentrates these electrons and generates a tremendous force that can be transmitted over vast distances in the form of blue rays penetrating through iron and stone. These rays, when focused at a point, destroy organic life and melt metals. The rays are focused by huge concave mirrors with the target located at the focus.

Tolstoi's infrared rays

A. Tolstoi, in his novel "Giperboloid inzhenera Garina" (Engineer Garin's Hyperboloid), describes an imaginary apparatus by means of which lethal heat (infrared) rays could be obtained.

The model used to build large-scale equipment is shown in Figure 4a and b.

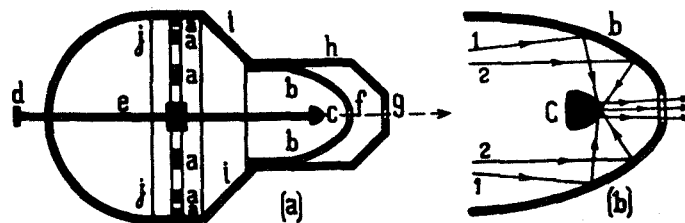

FIGURE 4. A. Tolstoi's infrared rays

Inside the cylindrical envelope h there is a surface bb in the shape of a hyperboloid of revolution with a reflecting inner surface. The envelope h is joined by junction ii to another dodecahedral envelope jj with a spheroidal end. Inside the latter there are 12 small porcelain cylinders fixed on a
14 bronze support. The cylinders contain special, smokeless pyramid-shaped candles, made up of a mixture of aluminum and ferric oxide (thermit) with solid oil and yellow phosphorus. Heat rays emitted by the burning pyramids are reflected from the inner surface of the hyperboloid bb and collected at its focus, where the second hyperboloid c is installed on a bar e, driven by a screw d. The heat rays reflected from the second hyperboloid pass in a parallel beam through apertures f and g and burn everything on the way. By moving the hyperboloid c left or right, the thickness of the beam may be varied.

Figure 4b shows on an enlarged scale the path of the rays.

Hyperboloid c is made of shamonite, a perfectly polishable refractory mineral. The effect of a full-scale device of this kind located on top of a tower 5 km away from an aniline paint plant in Germany is described

below (500 tons of an explosive called tetryl was kept at the plant at the time).

"Straight as a needle, the luminous filament traced its path from the tower directly to the plant. Its path was marked by a flashing swallow, by a burning flock of birds.

The first blow of the ray hit the chimney. It wavered, cracked in the middle, and toppled. Almost immediately to the left of it a column of steam rose over the roof of a long building, turned pink, mixed with black smoke. Farther to the left there was a five-storied building. Suddenly all the lights in it went out. A fiery zigzag snaked from the top to the bottom over the entire front wall, again and again, and the building sank, collapsed, its framework shrouded in clouds of smoke. Soon half of the plant buildings blazed like card houses. The infrared ray madly danced amidst this destruction, feeling its way to the heart of it all - the stores of semifinished explosives. The glow spilt over half the sky. Clouds of smoke, yellow, brown, silvery-white sheaves of sparks erupted above the mountains.

"One could see along the chalky bands of roads some live jumble crawling from the city. The line of the river reflecting the fire appeared speckled with black spots. This was mass exodus, people escaping to the plains. But... it was too late to escape. The grassy field between the city and the plant covered with long rows of tiled roofs suddenly swelled. Insane flames erupted through the cracks in the ground. A blinding column of extraordinary brightness then reared from the flames: a mountain of fire and incandescent gas, a blazing pyramid reaching higher and higher. The sky seemed to have evaporated over the entire plain. Space was suffused with greenish-pink light. Each twig, each shred of grass, each stone stood out in this light as during a solar eclipse.

15 A shock... A thunder... The cracked earth began to roar, mountains shook. A hurricane shook and bent trees. Stones and charred logs started to fly. Clouds of smoke entangled the plain. Darkness fell. And in the darkness, a second blast went off. The smoky air was saturated with dark-red purulent light..."

By means of the hyperboloid the author later hopes to harness "atomic fission."

Belyaev's psychic rays

A. Belyaev, in his science-fiction novel "Vlastelin mira" (The Master of the World), gives a complete picture of the great power that could be achieved by man once he learnt to transmit, by means of powerful generators, rays that affect the human psyche. The hero of the novel, Stirner, a German, invented such a machine and thus achieved extraordinary power. However, encountering a powerful adversary in the Russian inventor Kachinskii and having grown tired of the constant fighting, he induces himself, by means of his machine, to forget the past and to start a new life as a different person. The operation of the machine is explained by Kachinskii in the following way:

"I found a number of very close analogies between the structure of the nervous system and the brain, on the one hand, and radio-station design, on the other. The brain particles play the combined role of a

microphone, a detector and a telephone; the neuron fibrils with the little spiral at the end are remarkably similar to the solenoid coils; the result is self-inductance... From the physiological point of view, even the professor of physiology working with me could not satisfactorily explain the purpose of the neuron spiral. From the viewpoint of electrical engineering, however, it is quite logically explained. Nature evidently created this spiral to amplify electrical currents. There are also Raund lamps in the human body - these are the ganglionic bulbs of the heart. The energy source of the heart corresponds to a bank of storage batteries, and the peripheral nervous system provides the ground. Thus, by studying the constitution of the human body, I came to the conclusion that it is a complicated electrical apparatus - a complete radio station capable of transmitting and receiving electromagnetic vibrations.

"I experimented with thought suggestion upon animals. The experimenter stood on a cage of dense steel mesh mounted on insulators and a dog was placed in front of the cage. When the cage was not grounded, the dog successfully followed the experimenter's mental commands. Incidentally, the electromagnetic nature of brain and nerve vibrations was proved in the work of Lazarev, Bekhterev and Kazamali.

"Once the exact nature of these waves is known, it is no trouble to reproduce them by mechanical means. Amplified by transformers, the thought waves will flow as an ordinary radio wave and will be sensed by people.

17 "My machine consists of an antenna, an amplifier using transformers and cathode lamps, and inductive coupling with the antenna oscillatory circuit. You can aim a particular thought at my "transmitting radio antenna," which will amplify this radiation and transmit it into space. This new "gun" will actively influence people and subordinate their will to ours."

Figure 5 shows some circuit diagrams of the above device.

"To isolate oneself from the thought waves of the adversaries, one should be covered with a thin metallic net. The electromagnetic waves radiated by the adversary will precipitate on the net and leak to the ground. We will be insensitive to incoming radiation, but the insulation will simultaneously deprive us of the ability to transmit our thoughts. One may of course use mechanical aids, e.g., a "brain machine" which, like a gramophone, will first record the thought to be communicated and then, at a programmed moment, will automatically transmit it."

The facts of which Kachinskii is speaking took place in reality and were reported by B. B. Kazhinskii, an electrical engineer working on telepathy.

Figure 6 shows a diagram of his system. Legend:

MDT - microphone-detector-telephone - brain particles registering vibrations in the consciousness;

S - solenoid coils, self-inductance, neuron fibrils;

K - condensers, neurodendrons;

R - rheostat - the length of a nerve fibril;

L - Raund lamps, triodes - ganglionic bulbs of the heart nerves;

B₁ and B₂ - storage batteries, energy source - the heart;

A - antenna - the sensitive corpuscles of the nerves;

Z - grounding - peripheral nervous system.

(16) Beamed transmitting antenna

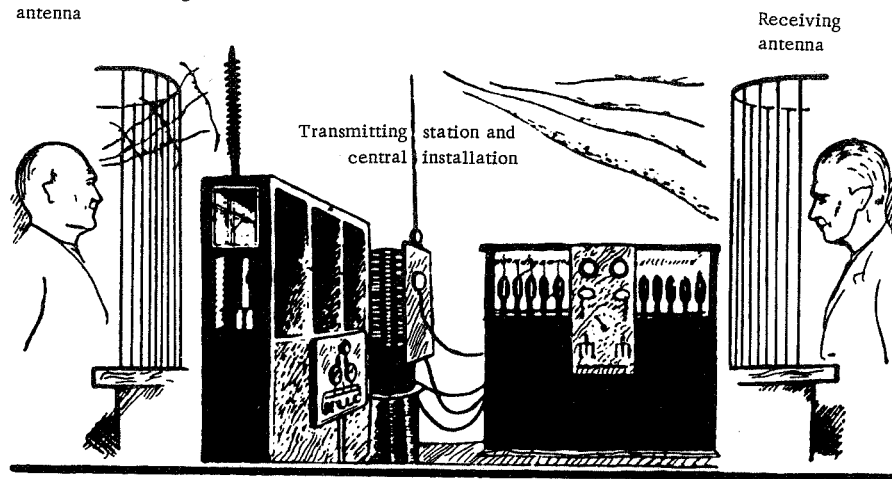

FIGURE 5. Belyaev's psychic rays

(16)

Transmitting circuit

Receiving circuit

Receiving circuit, high amplification

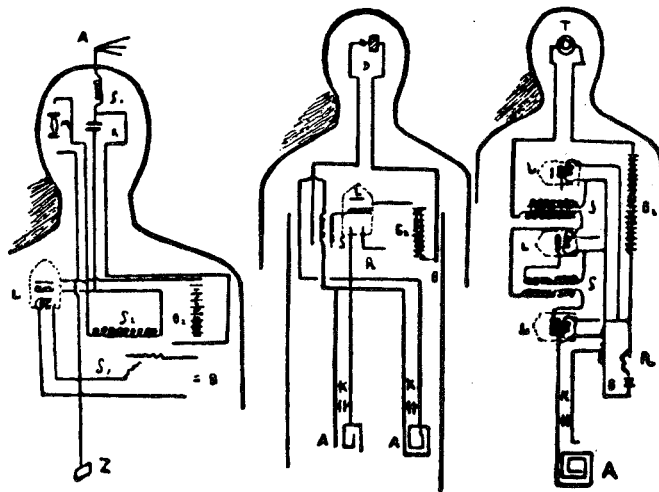

FIGURE 6. Kazhinskii's rays

Orlovskii's psychic rays

Orlovskii, in his science-fiction story "The Horror Machine," describes special machines capable of radiating energy waves that affect people's psyche at a distance.

The action takes place in America. The effect of the waves is described in a cable:

"Horror Epidemic in Roanoke"

"Population left city seized with groundless fear. Life came to a standstill. Banks closed. Trade ceased. Threat of famine."

Other cables informed of a mass erotic epidemic embracing Atlanta City and the adjacent areas. . .

18 One of the Russian scientists in Leningrad, S. Morev, had long been studying man's mental powers and the problem of influencing them by mechanical means. His idea was the following: "All the mental and physiological processes in a living organism are related to electric currents going through the nerve tracks; these currents are discontinuous, pulsating, and they radiate electromagnetic waves into space. Therefore, if two individuals are tuned in unison, i.e., are capable of radiating equal wavelengths, a current in the nerve tracks of one individual induces corresponding currents in the nerve tracks of the other. This is the reason behind one man's influence on another. The scientist found how to extend the range of tuning and in this way to study human psyche. He invented two instruments: one to sense and record electromagnetic waves radiated by human cerebral nerve centers, and the other to isolate our psyche from the influence of such waves.

Paralleling Morev's research, another scientist, D. Elicott in America, was working on a machine emitting electromagnetic waves which could affect the psyche of people from a distance, producing desired moods and feelings depending on the wavelength. His radiated electromagnetic waves causing in different places in America phenomena such as those described in the above cable.

Mukhanov's destructive rays

N. Mukhanov, in his science-fiction novel "Pylayushchie bezdny" (Flaming Abysses), says that by the year 2400 the Earth's inhabitants have mastered a number of new "rays" which revolutionized war techniques and which were "shot" instead of missiles from fighting spacecraft. Small spacecraft emitted nebulium sigma and tau rays, whereas the large ones emitted the theta rays of the same element. The speed of sigma rays is 180,000 km per sec; they decompose into components any complex matter encountered on the way. The tau rays reaching a speed of 200,000 km per sec convert matter into atomic dust. Finally, the theta rays with a speed of 220,000 km per sec transform everything into a new kind of cosmic force which produces reverse motion. Against each of these kinds of destructive energy there is a counter-energy, which remains a military secret.

New composite rays of nebulium and another, previously unknown element from a distant solar system, called "Secret," were also discovered. The

newly discovered force was called "nebulium omega rays." The speed of the rays is 280,000 km per sec, and the range is unlimited. Its basic property is to turn all matter into some primary element.

19 Martians, however, also used destructive rays. This is how Mukhanov describes the effect of the Martian rays on Earth during a war: "The air and the sea glowed with green rays falling almost vertically like rain. The rays grew into dense currents and everything around was lit up by an unbearably bright, enchantingly beautiful emerald light. The sky, the ocean, the setting Moon — all was lit up with a green blazing fire. A transparent emerald mist like a blind wall moved toward the shore after chasing away the pink dawn.

The menacing breath of something unpreventable, horrible and powerful passed through the morning freshness.

From afar came a monotonous irksomely-vibrating sound, carrying all the whispers of the ocean.

Waterspouts, like gigantic emerald coils, stretched toward the far-away sky. The island began to glow with green flames. Stifling stench of sulfur rose in the air. It became unbearably hot, there was not enough air, and all motion was paralyzed.

A vibrating sound with voice-drowning howl cut through the air. These were the Martian "feluifa" rays.

Green hell raged on the Earth's surface. The sea roared and bubbled, coiling into gigantic emerald waterspouts. The rocks were steaming. All vegetation turned to dust. The vibrating howl, like a million demons, raged over an ocean of green blood.

Finally, the attack ceased and the gases cleared away. All the rocks, like old bronze, were covered with dense green bloom. Here and there the stone subsided and seemed to have melted. Not a blade of grass was left on the entire island. Where the ship stood on watch, a green heap of tortured semi-molten metal was left.

Certain places in Asia were sheltered from the enemy by a wall and a roof of radio-currents of the highest voltage. Only aircraft equipped with special instruments cancelling the action of the radio waves could penetrate this lethal hemisphere, and even they only at certain points, through narrow air corridors.

When an enemy aircraft accidentally hit this invisible barrier, it was spun in the air forming a glittering circle. A moment later, flashing like ball lightning, the aircraft was hurled down to the cliffs, leaving a fiery trail, like a comet tail."

Filippov's rays

Around 1903 a chemist named M. M. Philippov died mysteriously in his laboratory in St. Petersburg. His death caused a real sensation.

20 Apparently he had discovered a new method of detonating remote explosions, so that the range of the explosion could reach a few thousand kilometers.

All the manuscripts and instruments of the deceased, however, were sealed and confiscated by the Secret Police, and disappeared without a trace.

I think that the deceased anticipated the ideas that only now attract the attention of the scientists and that the solution of the problem of remote energy transmission, that he perhaps had found, is near.

Anti-aircraft rays

In the year 1923 newspapers carried sensational reports of rays apparently discovered in Germany which could stop the engines of aircraft, cars, tanks, etc.

This problem was discussed in technical journals abroad. "Bulletin Belge des Sciences Militaires" (December, 1923) came to the conclusion that such an invention was possible; as an example it was mentioned that in 1908 the Colorado Electrical Power Company had been put out of order and all its machines had burnt out as the result of the high frequency instruments operating in Tesla's laboratory a few kilometers away from the power station. The output of Tesla's equipment was 300 kw, there was no antenna, and the resonance that caused the disaster was quite accidental.

An article published in the U. S. Coast Guard Journal (January, 1924) discussed the same problem. France was particularly worried when on her Paris-Bucharest airline eight incidents of engine failure took place over the same spot in Bavaria.

Simultaneously, remote car control experiments were conducted in France.

Since the disturbing effect of the rays on engines can become apparent only in the operation of the magneto and the spark plugs, the fuel mixture should be ignited by compressive heating and not by means of electricity, to counteract the rays.

Finally, the electric parts can be protected with suitable covers impermeable to the dangerous waves.

Rubus' "revolutionite"

Lev Rubus, in his novel "Zapakh limona" (The Lemon Scent), describing the struggle against British espionage in the USSR, tells of a new substance, which he called "revolutionite," emitting radiant energy of extraordinary power. This substance was found in the meteorite that fell in one of the remote ravines in the Caucasus. The meteorite was made of something similar to quartz, but was very dark in color, heavy, and had a characteristic conchoidal fracture. Inside the meteorite there was a piece of extremely active substance unknown on Earth. It had the following effects upon surrounding objects:

- 21 1. Thermal effect: It causes intense heating of all nearby objects. The air in the ravine was heated to 60°C.
2. Electromagnetic effect: Under its influence, the compass arrow jerks as in a strong magnetic storm. All the lines of force are intertangled. Moist tree leaves and the cliff edges shine with St. Elmo's fire.
3. Chemical activity: Water shines and acquires an acid taste even without coming into contact with the substance. The soil changes its texture. In

general, this treasure conceals a tremendous reserve of energy, greater than radio and simpler in application.

The active substance also emits vibrations of very high frequency which are not sensed by our organs; these vibrations are detected by technical means and are seen to intensify almost all known electromagnetic processes and chemical reactions. A minute particle of the substance increases to incredible intensities all the known power sources. It will enable all the factories to operate, hundredfold harvests to be obtained, and outer space to be conquered.

The slab that has been found will suffice for several millennia. To protect other substances from its effects, they should be wrapped in litharge paper (saturated with lead oxide solution). After various romantic adventures, the nugget finally falls into the hands of the Soviet authorities.

The author concludes the novel with the following words:

"A new force came into being. This force is revolutionite. Revolutionite is now the property of the workers. The struggle for revolutionite is over. Now the struggle with revolutionite in our hands begins."

Jack London's "energon"

Jack London, in his short story "Goliath," describes the destructive and cultural effects of a new source of radiant energy, which he called "energon."

Energon, he explains through the mouth of his hero, the inventor Goliath, is the cosmic energy contained in the solar rays. With its help humanity will make its life easier since energon will do the work of the people. Radium, radium salt and other compounds are obtained when it is manufactured from solar light.

At first, Goliath uses energon to subordinate all the governments to his will. He destroys enemy warships and entire squadrons sent out against him, blows up military plants and ammunition storages. When the world finally surrenders to his demands, giving up the system of war in favor of an era of peaceful labor and happy life, he publicly announces the secret of energon production (in 1937). With the use of this powerful energy source, the two-hour working day is reduced virtually to nil. Work becomes easy, like a game...

Zarin's ball lightning

A. Zarin, in his short story "Priklyuchenie" (The Adventure), describes a number of mysterious fires in Leningrad that started due to arson by unknown malefactors who discharged a ball lightning from a great distance.

The heroes of the story discover the malefactors by accident, when they see them at work from a facing window.

"A man with strange apparatus stood at a table. There were three iron rods near him, with three glowing spheres floating toward them.

When the spheres touched the rods, they were extinguished. Once, one of the spheres escaped from the room and did not return: this incident

coincided with a fire in a factory. Another time, a luminous spot appeared in the apparatus, quickly grew to the size of a small ball, separated, and giving out a pale blue light started floating in the air. A second and a third one followed. . . Soon after they appeared, another plant caught fire. . . " Such was the effect of the ball lightning directed by a generator to a particular target.

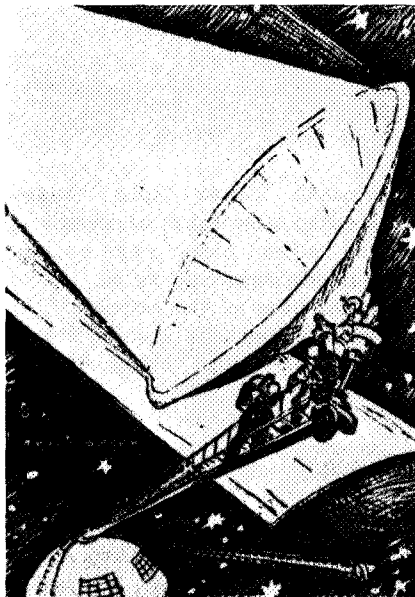

FIGURE 7. Laffert's heat rays

Laffert's heat rays

K. Laffert, in his novel "Weltenbrand," gives a description of an "ether" station, built by man (20-30 years after our time) in space a few thousand kilometers from Earth. This station, which was a kind of an artificial planet revolving around the Earth as its satellite, was occupied and manned by several engineers who operated the huge mirrors by means of which the reflected solar rays

were directed to different places on Earth to regulate the local climate. Figure 7 shows the top part of the station and two mirrors.

23 In another novel, "Fanale am Himmel," Laffert describes a cosmic station 100,000 km from Earth built by the "Peace League" - a society aiming to prevent wars among countries on Earth. The station was artificially built from materials transported from Earth by means of rockets. Near the station one thousand mirror reflectors made of silver foil were set up. The diameter of each reflector was 30 m. The complete reflecting area was 280 hectares. By means of these reflectors, solar rays could be collected and reflected to any place on Earth, resulting in complete destruction of the target.

The same station could also send to Earth sound waves of various pitch.

Pietsch's rays

A German writer Otto Pietsch, in his novel "Bicox and Co." (1925), describes an invention due to one Edwards (an American). It collects maximum solar energy at the equator, concentrates it, and directs it without wires to any point on the globe. For example, he could create daylight in New York at night by sending solar rays from Ecuador, supply power for

factories in Ireland, etc. The inventor also designed a special ring from an unusual metal which transmitted the accumulated solar energy into transformers to be converted into a powerful current counteracting the Earth's gravitation. All objects falling inside the range of this current escaped from Earth into a solid state.

Bain's rays

Albert Bain, the author of a science-fiction novel "Ether-Alpha," based his story on the affect of powerful rays produced by liberation of atomic energy. These rays were obtained by means of radium alpha rays acting on the helium nuclei, at atomic bombardment speeds reaching up to 100,000 km per sec. By means of this energy, the hero of the novel transforms the universal ether first into liquid and then into a solid state. From this solid ether he then builds an interplanetary ship, "Ether Alpha," and flies to the Moon.

Aiya's rays

E. Zelikovich, in his science-fiction novel "Sleduyushchii mir" (The Next World), describes lethal rays invented by the inhabitants of Aiya, a satellite of Saturn. Their interplanetary ships were spheroidal with circular objectives of bright-red color, about 5 cm in diameter, on the rim. These objectives radiated atomic energy supplied by the powerful generators located inside the ship.

When on another of Saturn's satellites, Yuivi, a war broke out, the inhabitants of Aiya arriving in their ships put an end to the war by means
24 of their rays; these rays melted guns, battleships and aircraft, burnt fortresses, rendered the air incandescent, blew up missiles. . . As a result, the war stopped and a united republic was formed on Yuivi.

The Selenites' electric rays

Bain, the author of the science-fiction novel "Ether-Alpha," describes the adventures of his heroes who by means of an interplanetary ship landed on the Moon. The Moon in this novel is inhabited by the children of radium. Electric life reigns on the Moon and the intelligence of these creatures is a product of electric vibrations. They look like multicolored star-shaped lights.

These Selenites, fearing a new exodus of man to the Moon, decide to destroy all life on Earth by means of electrical waves that give rise to earthquakes, fires, floods, etc. The hero, however, indicates a way of defence from these rays by means of an ether screen, shielding the Earth from their lethal effect.

RADIANT ENERGY IN SCIENTIFIC PROJECTS

Grindell Matthews' death rays

The concept of defeating the enemy by rays is over 2,000 years old: according to a legend, Archimedes during the siege of Syracuse in 210–212 B.C. burnt the Roman navy by concentrating and reflecting the solar rays by means of mirrors.

During World War I this idea intrigued many inventors.

The English inventor H. Grindell Matthews, whose experiments with new electric rays are illustrated in Figures 8–11, offered his invention to the British government in 1924. For his inventions in the field of electrical engineering he received a Government subsidy of £25,000 during the War.

As he informed representatives of the British press, following his laboratory experiments he intended to test his invention on a large scale in the open and hoped to transmit the energy of the rays over a great distance.

The experiments that Matthews conducted before the representatives of the press consisted in the following:

1. The rays issuing from a small projector interrupted the ignition and stopped a small motor from a distance of up to 15 m (Figure 8).
2. The rays exploded gunpowder at a distance (Figure 9), the electric current passing through 3-inch plate glass covering the table and grounding through the table legs.
3. The rays acting on an "Osglim" electric bulb made it shine.
4. The rays could cure certain diseases (it remains a question exactly which).
5. The rays could kill a small animal, e.g., a mouse, from far away.

According to press reports, Matthews' rays could stop automobile and aircraft engines from a distance, blow up stores of explosives and ammunition, etc. Even pictures illustrating these, then nonexistent, applications of the rays appeared (Figure 10).

26 Figure 11 is a drawing of Matthews' proposed ray transmitter as envisaged by the English journalist Davis.

28 According to Matthews' commentary, three ray generators are set up on the sides of the transmitter. The rays are directed to a box where they are transformed into high tension electric rays. This "mystery box" is the inventor's secret; energy in the form of invisible rays is emitted from the box and may be directed at any object. At night the rays may be rendered visible and may serve two purposes: illumination and destruction.

According to preliminary calculations, it should cost about £ 3 million to encircle London with a barrier of such ray transmitters.

(26)

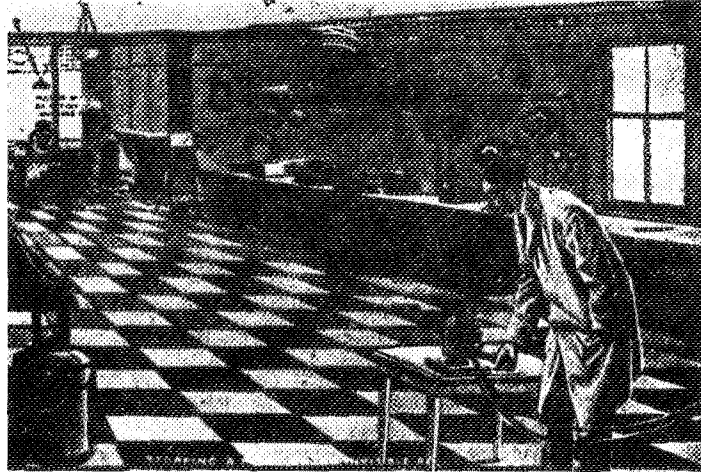

FIGURE 8. Stopping a motor by Matthews' ray

Let us examine various kinds of electromagnetic waves and see to what extent some of them correspond to Matthews' death rays.

The spectrum of electromagnetic waves for wavelengths from 25,600 m to thousandths and even smaller fractions of micromicrons is given on p. 22 in tabular form.

The analysis of the different kinds of radiant energy shows the following (according to Lyamskii):

(26)

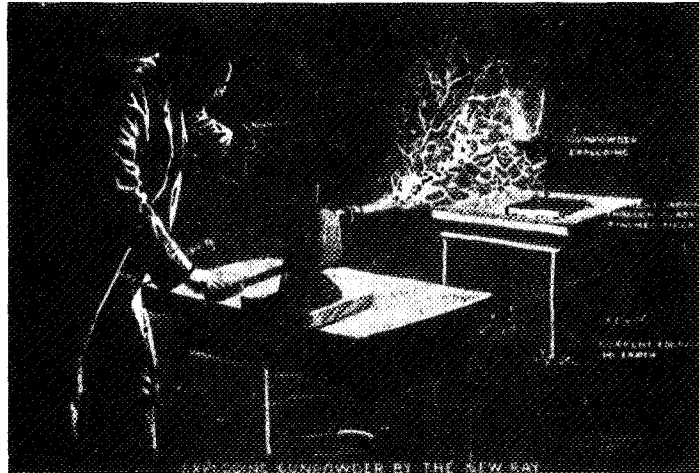

FIGURE 9. Exploding gunpowder by Matthews' new ray

(27)

19



FIGURE 10. Matthews' "devil" rays

The intensity (brightness) of the rays decreases rapidly (according to the law of "inverse squares") with distance from the source. In optics, propagation without attenuation can be achieved with the aid of collecting mirror-projectors. The purpose of the mirrors is to counteract the spreading of the rays by sending them in parallel beams. A strictly parallel beam, however, is only possible if the ray source is a point; in practice, however, the source has a finite area. Even the crater of an electric arc (1.5 cm in diameter) produces a beam divergence of 1 angular degree in a projector 2 m in diameter; even with such a small divergence of the beam, the brightness at a distance of 1 km is attenuated 400-fold. A larger source, tens of centimeters in diameter, would produce with the same projector a beam divergence hundreds of times greater. Increasing or decreasing the projector will not help; a small projector will produce a larger angle of beam divergence, and a large projector will reflect a wider beam, i.e., lead to considerable attenuation.

(28)

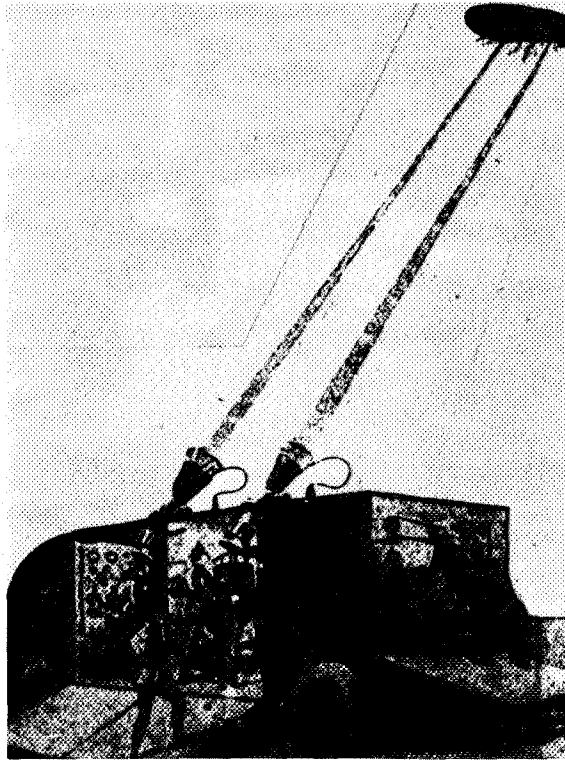

FIGURE 11. Matthews' future rays

Besides, the reflection of the rays from mirrors is different at different wavelengths. The longer waves are poorly concentrated by mirrors. It is easier to collect rays of medium wavelengths by reflection from mirrors, but the shorter the wavelength the greater the proportion of the

ray dose that is absorbed by the mirror and scattered by its surface. To reduce the absorption, an appropriate mirror material is chosen, for example, it is made of glass of a special chemical composition. Ray scattering is suppressed by surface polishing, but even the finest finish of the mirror surface achieved by modern science is too rough for rays of wavelengths shorter than 0.0003 mm. Therefore, modern projectors cannot be used for transmission of ultraviolet rays or shorter wavelengths since only a small fraction of source energy passes into the reflected beam.

In vacuum, rays of any wavelength propagate quite freely, but in gaseous media shortwave rays are extinguished. The shorter the wavelength and the denser and more inhomogeneous the medium, the greater is the absorption and the scattering of the ray energy. The Earth's atmosphere is an inhomogeneous medium which extinguishes the shortwave ray energy. In clear weather, the visible rays lose only about 10% of their brightness 1 km from the source, whereas the ultraviolet rays lose over 99%. The still shorter waves — the X-rays — do not pass any further than a few meters in the Earth's atmosphere.

The Hertzian rays have no immediate effect upon the living organism. Since they cannot be made to propagate in a concentrated beam, the transmission of any considerable power to a distance at these wavelengths is so far infeasible.

The "dangerous" spectrum region starts from the infrared rays. These rays would be best for incineration, especially as the source temperature at maximum energy (about 1,000°) is easy to attain, and the Earth's atmosphere is almost totally transparent in the infrared. There are, however, no sufficiently powerful and yet small infrared sources, whereas the long-range effect of extended sources, as we have seen before, is negligible. That is why one cannot speak seriously of "incineration" of people and objects from afar by invisible rays.

Blinding by invisible rays seems just as inconceivable. The only suitable candidates are rays with wavelengths shorter than the wavelength of visible light (the ultraviolet spectrum). In view of the poor reflection of the ultraviolet rays from mirrors and their considerable absorption in air, long-range transmission of energy by these rays would require a ray-emitting source of incredible power. Besides, the construction of a radiant source for supporting a constant temperature close to the temperature of maximum intensity of ultraviolet rays (14,000 degrees) is absolutely impossible at this stage.

Besides incineration and blinding by invisible rays, other "lethal" effects are mentioned, e.g., the ulceration of skin. Prolonged exposure to X-rays has an ulcerating effect on the human skin. However, the range of these rays in air, even with the most powerful source, does not exceed a few meters. Thus, there is even less reason to speak of the long-range effect of X-rays than of the long-range effect of the ultraviolet rays.

Some other rays with special properties may exist in nature. These are the rays emitted by radioactive substances, e.g., radium and its chemical compounds. These rays are not wave-like oscillations; they are of a material, corpuscular nature — consisting of very fast inconceivably minute particles. When the source is close to the target, these rays are capable of damaging the living tissue, causing deep skin burns, blinding, etc. But even the strongest of these rays have a range of no more than 7 cm in air.

Modern science cherishes no hopes of creating a source with powerful radioactive rays capable of penetrating through thick layers of air. Therefore one has to admit that Matthews' invisible "destructive" rays and similar rays cannot be of a radioactive nature.

The conclusion is that all the invisible "lethal" rays that are now so terrifyingly described in the press pertain to the sphere of pure myths, like the "exploding" rays of the Italian Ulivi, which were so widely discussed prior to World War I, back in 1912-1913.

Table 1 presents some data on the properties and uses of various types of radiant energy.

31 TABLE 1. Radiant energy wavelengths

	Wavelength	Octave	Wireless telegraph
Meters (m)	25,600	—	Earth stations Transoceanic stations Stations on large vessels Stations on small vessels Amateur stations The longest waves produced by Hertz in his experiments } Radio waves
	12,800	1	
	6,400	2	
	3,200	3	
	1,600	4	
	800	5	
	400	6	
	200	7	
	100	8	
	50	9	
	25	10	
	12.5	11	
	6.25	12	
	3.125	13	
1.58	14		
Millimeters ($\text{mm} = \frac{\text{m}}{1,000}$)	781	15	Hertzian waves The shortest waves (measured) Generated and measured Nicols and Tear, 1922 The shortest Hertzian waves
	390	16	
	195	17	
	97	18	
	48	19	
	24	20	
	12	21	
	6	22	
	3	23	
	1.5	24	
	0.76	25	
0.38	26		
Microns ($\mu = \frac{\text{mm}}{1,000}$)	343	27 28 29 30 31 32 33 34 35	The longest heat waves (Rubens') infra-red rays The shortest heat waves; edge of visible spectrum (red)
	190		
	95		
	47		
	24		
	12		
	6		
	3		
1.5			
0.75			

32 TABLE 1 (continued).

	Wavelength	Octave	
Angstroms ($\text{\AA} = \frac{\mu}{10,000}$)	6,700		Visible light
	3,750	36	
	3,900		
	3,000	37	Danger threshold for vision, danger becoming more acute at shorter wavelengths
	1,875		
	937	38	Ultraviolet rays
	468	39	
	234	40	
	117	41	
	58	42	
	29	43	
	14.5	44	Beginning of X-rays
	7.25	45	
	3.6	46	
	1.8	47	X-rays
	0.9	48	
	0.46	49	
	0.23	50	
	0.115	51	Gamma rays
	0.057	52	
0.028	53		
0.004	54	(Hess-Millikan's) cosmic rays	
0.00067		Millikan's new rays	
0.00021			

Note 1. Below the first octave the number of oscillations per second is $n = 10^1$; above the 54th octave, $n \geq 4 \cdot 10^{19}$.

Note 2. An octave in relation to an oscillation of a given frequency is defined, by analogy with sound, as an oscillation with double frequency. For radiant energy, the velocity of wave propagation (V km per sec) is equal to the wavelength (1 in km) multiplied by the number of oscillations (n per sec) or $V = \lambda n$.

A more detailed analysis of electromagnetic waves is given by V. Kulebakin in his article "The Death Rays" published in Vestnik Vozdushnogo Flota, No. 8. 1924.

I. Radio waves. In radio engineering and in the engineering of high-frequency alternating currents, electromagnetic waves with wavelengths of 50 to 1,000 m are used. Their properties are well known. They do not cause unpleasant sensations in people. As a proof of this, Figure 12 shows a picture of a person sitting calmly near artificial 4 meter long lightning produced by means of Tesla's transformer. They present no danger to explosives either. They do affect an Osclim electric bulb and it begins to glow. The radio waves usually applied in engineering (these are spherical waves propagated in all directions from their source (Figure 13) and losing energy with the distance from the source) are hardly capable of ignition disturbance in internal combustion engines, even from a distance of 10–15 meters. In general, such disturbance is realizable but only by means of a radio transmitter of tremendous power, even if instead of spherical waves plane-parallel waves are used, generated by a radio projector of sorts (Figure 14). These waves may affect an electric bulb, making it glow; they may also disturb engine ignition.

2. Hertzian waves. The corresponding wavelengths are from 1 mm to 100 m. The waves may be reflected by mirrors in the form of a parallel beam; they disturb engine ignition and make electric bulbs glow; they are harmless to health, like radio waves.

3. Ultra-Hertzian rays. They are similar in all respects to heat waves.

4. Infrared or heat waves. They may be collected into parallel beams. They may ignite gunpowder, cause burns, and even kill small animals.

5. Light or visible rays. Their properties are well known.

6. Ultraviolet rays. Depending on the method of application and on the intensity, they may have a beneficial or a harmful effect upon the organism.

They may ignite gunpowder and discharge electrified bodies, by ionizing the surrounding medium and thus turning it into a conductor.

7. X-rays have a very short wavelength and are not reflected by mirrors. They may have a harmful physiological effect and, like the ultraviolet rays, may discharge electrified bodies by ionizing the surrounding medium.

Conclusion. Matthews apparently used the following method for his teletransmission: First he directed a parallel beam of X-rays (collineated by a lead diaphragm) ionizing the



FIGURE 12. Tesla's lightning

medium between the apparatus and the target. The ionized medium provided two conducting channels for the transmission of energy of another type. However, the creation by such means of weapons to be used against the air force and the human resources of the enemy will require extremely powerful installations and it is still premature to judge the practicability of Matthews' invention.



FIGURE 13. Radio waves



FIGURE 14. A radio projector

The described effect of Matthews' rays served as material for the science-fiction novel by N. Kochergin "The Electropolis." — Vokrug Sveta, No. 31, Leningrad. 1929. The author describes how the hero of the novel forced an enemy aircraft to land by means of these rays.

Transmission of electricity by radio

The great technical problem of wireless supply of power to engines, machines, and plants from a distance, by transmitting the power in wave form through space, has been worked on for the past 15-20 years. Many scientists felt that this research entered a blind alley when it became apparent that the problem could not be solved by concentration of electromagnetic waves in a narrow "radio beam." "Beamed" radio transmission on short waves has been used since 1924; but a radio wave collected into a beam, even if it is generated by a multi-kilowatt transmitter, does not carry all the kilowatts; a lion's share of the radio transmitter's energy is spent in energizing the antenna electrons moving back and forth along the wire, i.e., in alternating currents generated in the antenna. Only a few percent of the energy are transformed into electromagnetic waves. An interesting phenomenon of wireless energy transmission is observed in the vicinity of powerful radio stations. Any two electric bulbs installed in a house near such a station, which are connected in parallel and are turned on by the same switch, will glow with a dull red light, even when disconnected from the mains, as they form a closed network and the current induced by the radio station flows in the wires between the bulbs and produces light.

35 On the whole, the prospects are very bleak. Yet, by proceeding in a roundabout way, modern physics is solving this problem.

It has been known for a long time that very short (shorter than 10 cm) radio waves are capable of ionizing the air, i.e., by splitting the air molecules into electrically charged radicals (ions) they make the air conduct electricity. Philip Thomas, working at Westinghouse laboratories in the United States, studied this phenomenon in the past two years. Ultrashort radio waves (5-8 cm wavelengths) transmitted in a very narrow beam ionize the air only in those places where the beam actually passes. Thus, an "invisible wire" consisting of the charged air molecules extends from the transmitter through the air; the electric current should flow along this path as easily as along a copper wire. When the angle of the transmitting antenna is changed, the "wire" also changes its direction.

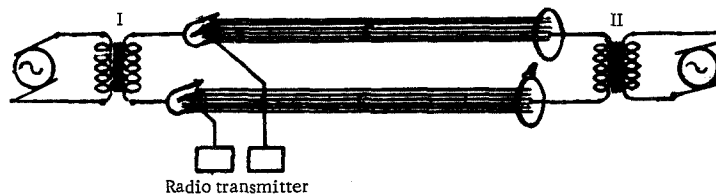

FIGURE 15. Wireless energy transmission

Thus, when a terminal of an electric machine is connected to the "invisible wire," the current from the machine passes through the air. The role of the radio transmitter is limited today to provisional "drilling" of an ionic channel through the air; energy is thus transmitted to a distance "through air," and not through "ether," as was originally thought.

Thomas observed this effect in his experimental installations in the laboratory of the Westinghouse Electric Co.: an engine was run by continuously supplying it with power passing through air from a generator located in another room. First, by means of a transmitting antenna he sent an ultrashort ray along the desired transmission path, thus making the air conduct electricity. Next to it another such radio ray was sent (10 cm wavelength), so that two ionized channels ("wires") were formed in the air, stretching from the generator to the target (in the above case, to the engine, Figure 15).

36 By connecting the ends of these "air wires" to the poles of an electric current generator (i.e., simply "piercing" the air in the proper places with metallic cones), and by joining the opposite sides of the "wires" with the poles of an electric motor, current circulation operating the motor will be obtained.

The above principle opens great perspectives for various purposes: death rays can thus be created for military use; in agrometeorology, artificial rains can be produced by directing electric currents into clouds; in national economy, a number of factories can be put into operation without power sources of their own.

Nodon's rays

A French physicist A. Nodon, in 1921 advanced a hypothesis that the Sun emits "ultra-radioactive" rays of very short wavelengths (from 10^{-29} to 10^{-69} cm), i.e., shorter than the distance between the electrons and the nucleus in the atom. Therefore such rays could disintegrate atoms.

37 Figure 16 depicts the electromagnetic solar rays enveloping the entire Earth and deflected by the Earth's geomagnetic poles. Probably under the influence of these deflected rays, the radio waves emitted by an American station are curved on their way to Europe, as shown in Figure 16. In his works, Nodon, observing the difficulty in radio communication above broad-leaved forests, came to the conclusion that these forests emit ultraviolet rays which interfere with radio reception.

Millikan's cosmic rays and Wilson's hypothesis

The results of physical research in the field of the so-called "Millikan's cosmic rays" or the "superpenetrating radiation," the existence of which has been suspected by scientists for over a decade now, is undoubtedly one of the most remarkable scientific achievements of recent years.

The idea of cosmic rays was engendered in the following way: It is known that an electroscope loses its electric charge in the air, i.e., it discharges. This phenomenon takes place even if the electroscope is surrounded from all sides by a thick lead screen which does not transmit ultraviolet radiation, X-rays, and gamma rays of radium (Rutherford's experiments, 1903). This phenomenon suggested to the physicists that special rays exist in our atmosphere capable of penetrating through a layer of lead a few

centimeters thick. Experiments of the German physicist G \ddot{o} ckel in 1910 during his flight in a balloon to an altitude of 7 km showed that the effect of such rays increases with altitude; this made him suggest that these rays are of cosmic and not terrestrial origin.

(36)



FIGURE 16. Electromagnetic rays of the Sun

In 1912–1914, two German physicists, Hess and Kalgorster, repeated G \ddot{o} ckel's observations, rising in a balloon to an altitude of 9 km. Their observations confirmed G \ddot{o} ckel's conclusions. Moreover, according to Kalgorster's observations, stars emit rays similar to X-rays but considerably harder, i.e., penetrating solids to a greater degree than X-rays. Kalgorster supposed that these rays are a product of atomic decay processes.

In 1922, Millikan, an American physicist, repeated these observations, sending an electroscope to an altitude of $15\frac{1}{2}$ kilometers on board a pilot balloon. Starting in 1925, Millikan conducted a number of experiments submerging electroscopes to various depths, in the clear mountain waters of Lake Muir. It turned out that the new rays passed freely through a water column corresponding to a lead layer 2 meters thick, i.e., their penetrating power is more than 100 times that of gamma rays, and the corresponding wavelengths are approximately the same factor shorter than the shortest known radiation — the gamma rays. Their oscillation

frequency is 10 times that of the visible light. The higher the altitude, the stronger was their effect.

In order to explain the discharge of the electroscope leaves in the open air, Millikan and his collaborator Cameron developed a theory of cosmic rays, i.e., of the effect of the radiant energy originating from atoms in the
38 abysses of interstellar spaces upon the air in the electroscope. These rays ionize the air in the electroscope, make it conducting, and so enhance the discharge. This hypothesis had to account for the tremendous velocities required for the rays to pierce the $5\frac{1}{2}$ meter lead wall encircling the electroscope, and to discharge it. Millikan thought that only the ultra-short waves of the cosmic rays could create the above effect.

The experiments of the last few years, conducted by the physicists Skobel'tsin in the USSR and Bothe in Germany, showed however, that to explain the electroscope discharge there is no need to resort to the hypothesis of cosmic rays with ultrashort waves, and the discharge can be experimentally proven by the influence of an electron stream from outer space. The electrons hit the air molecules, break them up into charged fragments, and ionize the air; the ionization causes the electroscope discharge. The velocity of these electrons, according to the calculations of the English physicist Stoner, should reach 99.999999% of the speed of light, which corresponds to their fall in an electrical field of a billion volts.

The cosmic hypothesis of the origin of "Millikan's rays" seemed to deliver the cruelest blow to a number of scientific aspirations and suppositions relating to survival in interplanetary space. Doubtlessly, the lethal effect of these rays on the living cells (note the occasionally fatal burns caused by X-rays, which are thousands of times less penetrating) cuts the ground from under the suggestion of transferring embryos from one celestial body to another.

If these cosmic rays are X-rays, they present a serious danger for the travelers in interplanetary ships, since they may cause body burns and eventually death. Even the thick metal walls of the spacecraft cannot protect one from the effect of these rays. This obstacle can be eliminated either by constructing the spacecraft from materials impenetrable to these rays, or by concentrating and collecting other rays of the solar spectrum, namely infrared rays, which cancel the effect of the X-rays, occupying a diametrically opposite position in the solar spectrum.

The cosmic origin of Millikan's rays, however, is so far only a hypothesis. Wilson, an English physicist, has recently advanced an entirely new and no less convincing hypothesis of the rays' origin.

He considers the Earth's atmosphere as the place of origin of the new rays, which are generated by atmospheric electrical discharges — thunderstorms and lightning.

The quantity of energy released during thunderstorm discharges (lightning) is tremendous but the total summary quantity was hard to
39 imagine prior to Wilson's calculations. From meteorological data he calculated that at any given time there are 1,800 thunderstorms on the average in the atmosphere. Each second 100 electrical discharges (lightnings) occur on the average. The total power released by these discharges is almost 6 billion horsepower, a fantastic number equal to almost three times the work done by all the power plants supplying all the factories in the world.

The terrestrial origin of Millikan's rays — if this hypothesis should take preference over the "cosmic" one — will have to throw off the aura of "lethality" from the new radiation. The slow generation of these rays in the atmosphere explains why even pilots flying at altitudes of 9–11 km do not suffer from them. Interplanetary space meanwhile is being "purified" for humanity to realize its grandest technical undertaking — flight to other celestial bodies. Millikan, however, rejected Wilson's hypothesis that the above-mentioned phenomenon is associated with thunderstorms. According to Millikan, the results are independent of the location of the experiment: whether it takes place in the mountains or on a plain, i.e., in locations with or without thunderstorms.

On the basis of his latest observations in 1927 in the Andes, in Bolivia and in California, Millikan came to the conclusion that the wavelength of cosmic rays is much shorter than that of all the known rays and that the cosmic rays moreover consist of four different groups of wavelengths: 0.00046 Å, 0.00012 Å, 0.00006 Å and 0.00003 Å, where Å is angstrom, a unit of length equal to one ten-thousandth of a micron.

These rays penetrate through a water layer 57 m thick or through 5 m of lead. The voltage generating such rays is about 60 million volts.

He further established that these rays are independent of the Milky Way and the Sun. All this leads to a hypothesis that the source of cosmic rays is beyond the solar system and the Milky Way. It should be sought in the nebulae, where the interior processes release huge quantities of energy and emit waves of very high frequencies. This confirms Jones's hypothesis (1917) that there exist stars with temperatures of 30–32 million degrees, where atoms disintegrate into free atomic nuclei and electrons. These atoms are heavier than the heaviest element known on Earth — uranium.

Millikan maintains that the cosmic rays are emitted not as a result of the disintegration of heavy atoms, but as a result of a reverse process of fusion of several light atoms into a heavy nucleus.

40 Tsiolkovskii's opinion on Millikan's rays

K. Tsiolkovskii, seeking to eliminate the lethal effect of Millikan's rays in outer space, writes:

"These cosmic rays penetrate through a layer of lead at least 10 m thick. The resistance of the atmosphere is no greater than 1 m of lead. Thus, these rays reach the Earth's surface almost unattenuated. Since they never kill anybody on Earth, a ten percent increase in their strength will not be lethal in outer space either.

Why is this so? The electric effect or action is manifested in an electric exciting force acting upon the current. All other kinds of vibrational energy have a similar effect. Its penetrating power (hardness) depends on the vibration frequency or on the electric exciting force. Millikan's rays have tremendous frequencies. Their effect, however, depends on the overall quantity of rays (i.e., the current intensity). The intensity is astonishingly small for Millikan's rays. Therefore their effect will be insignificant. And indeed, not a single bacterium has been killed by the cosmic rays."

It would be interesting to note the opinion of Maurice Faure, a French scientist, that Millikan's rays affect some sick people who feel worse in fine weather. The periods of ill health coincide with the passage of sunspots across the Sun's central meridian.

Grave's letter

Academician D. A. Grave wrote about cosmic rays in his address on space research and the conquest of space on 14 June, 1925.

The text of the letter follows:

"Many social circles have a skeptical attitude toward the subject of space research and conquest of space. People think that they are associated with imaginary projects of space travel in the spirit of Jules Verne, Wells, Flammarion and other science-fiction writers.

"A professional scientist cannot share this point of view.

"As long as five years ago, on the pages of the newspaper "Kommunist," I pointed to the need of exploiting the electromagnetic energy of the Sun.

41 "I was not motivated by my imagination but by the implacable logic of the facts. These facts are the following: the Sun covers the Earth with clouds of electrons and particles of dispersed ionized matter (ions, protons). Under geomagnetic attraction these electron clouds, as has been ascertained lately, fall on the Earth in the form of a gigantic waterfall forming luminous pillars in the upper layers of the atmosphere, whose length according to recent accurate measurements reaches 500 km. These clouds of electric substance around the Earth affect the geomagnetic field in such a way that it waxes and wanes in phase with the sunspot cycle. Approximately four hours after a large spot passes through the Sun's central meridian, a magnetic storm is observed on Earth. Of course, the total energy of a magnetic storm cannot be exactly determined, but rough data lead to the conclusion that during the strongest storms this energy reaches one million horsepower. Radio engineering provides scientists with the means to sense the electromagnetic activity of the Sun. This activity is manifested in disturbances which are strongest one hour after midnight. This is not surprising since it has been ascertained that electrons coming from the Sun to the Earth do not fall in a straight line: their paths curve and they hit the night side. This has been elucidated in detail by the calculations of the Norwegian scientist Størmer, for which he received a gold medal from the Paris Academy of Sciences in 1923. Thus, the electromagnetic energy from the Sun does mechanical work in the form of vibrations of the microphone plate of a radiotelephone. You may think that this work is of little importance but my duty, as a theoretician, is to point to the facts. It is the engineer's task to collect sufficient energy and to harness this mechanical work for the needs of our world.

"The only practical approach to the utilization of the electromagnetic energy of the Sun was outlined by the Russian scientist Tsiolkovskii, who described in detail reactive devices or interplanetary vehicles for this purpose, which will become tomorrow's reality. The organization of space research societies and the development of interplanetary vehicles is both

timely and expedient. Therefore, I heartily welcome any undertaking in this area and wish you success and fruitful work in the development of a new branch of engineering for the welfare of mankind."

The Hertzian waves of the Sun

According to Nordmann, the Sun, besides its heat and light rays, emits powerful Hertzian waves in great quantities. Their generation is particularly powerful in the area of sunspots and faculae and at times of peak activity. Moreover, the Sun emits magnetic rays and powerful ionizing rays which disintegrate atoms.

McLennan's new solar rays

42 Professor McLennan of Toronto University conducted in 1926 an experiment the purpose of which was to prove that the aurora borealis may be produced artificially by passing cathode rays through an airtight tube containing a mixture of 25 parts helium and 1 part hydrogen, which approximately corresponds to the composition of the upper layers of the atmosphere. It seems that a strong electric ray coming from a large sunspot produces the aurora borealis on interaction with the Earth's magnetic field.

Properties of the universal ether

What are the properties of the medium filling interplanetary space and the Universe? This is the question to be solved by interplanetary spacecraft and other instruments.

We can try to foretell, while still on Earth, at least some of these properties.

We assume that the temperature of interplanetary space is equal to absolute zero (-273°).

Kamerlingh Onnes, at Leyden, conducted a number of experiments with liquid helium, thus achieving a temperature of -269°C (near absolute zero).

It is known that the electric current passing through a conductor raises its temperature (incandescent lamp filaments). Suppose now that an incandescent lamp is placed at an altitude of hundreds of kilometers above the Earth's surface and suppose that one tries to ignite it by means of electricity. It would not light up because of the terrible cold; all the conductors would lose their resistance. Thus Professor Onnes could pass very strong currents through very thin conductors which under those conditions became, so to speak, superconductors. But these are not all the new properties of the supercooled medium. Since at absolute zero metallic conductors lose their resistance, current once injected into the

conductor will circulate in it indefinitely. In other words, perpetual motion, so to speak, will be obtained; so much energy, however, will be needed to obtain it that this method would be impractical.

Referring to the interplanetary medium one can assume that it is, so to speak, a superconductor because of the low temperatures, and the solar rays reach the Earth without any energy losses.

The force of gravity may also be likened to light in this respect.

In future interplanetary flights, it is possible to imagine a small dynamo operating outside the craft at absolute zero. Once started, it will continuously generate current for navigational purposes.

The Earth, the Moon, and the other planets already have this perpetual motion in the cold of outer space. Then why should man not achieve such a perpetual motor?

43 Matter in interstellar space (Eddington's hypothesis)

Questions such as "What fills the space between the Sun and the planets?" and "Does matter exist in interstellar space?" intrigued man for a long time and gave rise to a number of hypotheses.

Newton tried to deal with these questions, putting forth an assumption of the "slippery" light ether, transmitting light and other electromagnetic vibrations, but not resisting in the least the motion of the stars.

True, some scientists and writers considered such substance to have certain density. Edgar Allan Poe, in his science-fiction story "The Unparalleled Adventures of One Hans Pfaal," describes the flight of his hero to the Moon by means of a balloon filled with a gas which was lighter than the ether medium filling interplanetary space.

Observations, however, do not confirm the existence of such a medium. True, interplanetary space may contain gas particles, which have overcome a planet's gravity and escaped into space with cosmic velocities.

The phenomenon of the "zodiacal light," for example, is probably due to the effect and the activity of the solar atmosphere, reaching, although in a very rarefied state, to the planetary orbits.

According to Zöllner, Rogowski and Wegener, a steady exchange of gases takes place between the planets, which are regarded as local condensations of a common atmosphere, enclosing the entire solar system.

Eddington, a professor of astronomy at Cambridge, has recently advanced a hypothesis that rarefied matter exists not only in interplanetary but also in interstellar space. This matter envelops the entire Milky Way.

Eddington bases his hypothesis on the discovery of fixed absorption lines in the spectra of the hot double stars. If one of the two stars revolving around a common center moves toward the Earth and the other recedes, and the interstellar space is free from matter, the spectra of the two stars will be different. The receding star produces Fraunhofer lines shifted to one side, whereas the approaching star shows lines shifted in the opposite direction.

In reality, however, besides such shifted lines, other stationary lines are observed, corresponding to the lines of sodium and ionized calcium (i.e., calcium in a state that its atoms are lacking one or two electrons).

This indicates that between the star and Earth there is a medium
44 containing a gas cloud of sodium and ionized calcium. According to the observations of Plaskett from Vancouver, this cloud is stationary relative to the Milky Way. This medium, possibly, contains other substances besides sodium and calcium. Eddington also gives an approximate estimate of the density of this substance: 1 g occupies a volume of 60 million cubic kilometers. If its atomic weight is 20 times higher than the atomic weight of hydrogen, then on the average there will be one atom of the substance within 2 cm^3 . According to Eddington, the mass of this matter in the Universe is almost double the mass of all the stars. Although it probably offers negligible resistance to motion, its attraction should be noticeable and the stars should move around the center of this cloud. Stars with velocities above a certain limit (115 km/sec) may escape from this attraction and from the Milky Way. Eddington reached a paradoxical conclusion concerning the temperature of the particles in this medium. According to Eddington, the atoms should have temperatures between 10,000 and 15,000°C.

Thus, according to Eddington, the entire interplanetary and interstellar space in the Milky Way is filled with highly rarefied matter, and individual nebulae and stars may be considered as localized condensations of this matter. The density of these condensations may be very high (for example, the density of the satellite of Sirius is 53,000 times the density of water).

The danger that cosmic rays may present to the future interplanetary travelers attracted the attention of some novelists. F. Bogdanov, in his science-fiction novel "Dvazhdy rozhdennyi" (Born Twice), describes the attempts of people, 15-30 thousand years in the future, to protect themselves against these rays during interplanetary flights.

"An inventor of an alloy, which was sufficiently light and yet penetrable to the lethal interplanetary rays, set out himself on a hazardous flight. He was launched in a rocket at the time of the opposition of Venus, but a few hours later he fell back to Earth, dead. The scientists established that he died due to the effect of the cosmic rays. The rocket contained such a device that should the brave passenger die, the weight of his body would stop the propelling explosions below, and the entire missile would fall back. There were other attempts. In the year 20,000 another gigantic rocket was launched, with 10 people on board, but until now they have not been heard of. . . "

Finally, in the year 35,000 some professor discovered a way to shield interplanetary ships from these rays.

He proposed to fill the thin and light capsule of the rocket with a light gas mixture, impenetrable to the cosmic rays. Of course, the author does not specify the composition of the mixture.

Goldman's "lethal sounds"

The newspapers carried sensational reports that Professor A. G. Goldman
45 had discovered a radical effect of ultrashort sound waves upon living organisms,
which is of interest not only to biologists and physicians, but also
touches upon a number of the finest problems of the modern science
of matter.

These experiments, begun at the end of 1924, were the first scientific
attempt to examine the question of the effect of vibrations transmitted through
air. Before Goldman, physics did not pay much attention to such a standard
and old-established branch as acoustics.

Last year in July, however, the American physicists Wood and Loomis
produced inaudible ultrashort sound waves (wavelengths 6 to $1\frac{1}{2}$ mm).
Independently from the Kiev scientist, they constructed a "shortwave sound
vibrator": a quartz plate vibrating under the effect of alternating current
with a frequency of up to 400,000 cycles per second, and showing a number
of surprising results which are described below.

Our hearing perceives only sounds with not more than 40,000 cycles per
second, while dogs hear sounds of higher frequency, which are inaudible to
man. Recently a whistle has been built, in Germany, which produces sounds
with much higher frequencies than are perceptible to the human
ear. This whistle, totally inaudible to man, creates a marked impression
on dogs. This particular ability of the dogs was used for police purposes.
When seeking or pursuing criminals with police dogs, it is often necessary
to control the dogs with calls or signals which are not heard by the pursued.
The use of the ultrasonic whistle, according to the German Police Department,
markedly simplified the search for criminals.

Is it possible that sound waves may have some deep "lethal" physical
effect on living matter?

This question receives a totally unexpected treatment in view of the
recent advances in the branches of physics dealing with all kinds of material
vibrations. Only 15 years ago the different vibrations were divided into
three fundamentally dissimilar categories: 1) molecular-atomic heat
vibrations: heat is the result of random motion of constituent particles,
whose velocities determine the temperature of the body; 2) electromagnetic
vibrations in ether, in particular light — a process connected with vibrations
of the atomic electric charges; and, finally, 3) elastic (acoustic) vibrations
of solids.

The gaps between these categories of vibrational motion, which on the
whole cover the mechanism of almost all the natural phenomena, were being
filled gradually.

First, the contradictory duality in scientific approach to the nature of
heat, which was regarded simultaneously as being due to the mechanical
46 motion of molecules and to electrical vibrations (infrared "heat" rays),
was resolved by Einstein's brilliant work, soon after the publication of his
famous treatise on the theory of relativity. Both forms of heat, mechanical
as well as electromagnetic-wave-like, are due to the same vibrational
motion inside the matter. When the atomic electrical charges oscillate
and the atoms emit infrared radiation, they in effect are taking part in a
random "heat" motion.

A few years later, an unexpected merging of acoustics and heat into one common branch of physics took place. The elastic vibrations of solids were found to be basically similar to the atomic thermal motion, and therefore, to the light radiation emitted by atoms.

The same vibrations of material particles may, therefore, manifest themselves in three different ways: they produce the infrared radiation that propagates in wave form in ether, they give rise to sound that propagates through the air; and, finally, they produce the temperature which is measurable with a thermometer. The air and the ether become interchangeable media for propagating strong electromagnetic disturbances and for transmitting them from one body to another.

These revolutionary conclusions determine an entirely new approach to the physical potential hidden in the vibrations of air. When passing from the low-frequency sound waves perceived by human hearing to the high-frequency waves, one may now expect not only the penetration of these vibrations into the human organism (like the short electromagnetic waves — X-rays), but also the excitation of atomic disturbances within the living tissues. Hitting different parts of the living tissue which are in resonance with the incident sound wave, this wave should excite strong vibrations in the appropriate points of the living tissue; these vibrations may directly affect the thermal motion in the tissue, be transmitted to the electronic level of the atoms, and may even lead to an explosion — a catastrophic destruction of the living cells.

These theoretical views were recently confirmed by the experiments of Wood and Loomis. The water along the path of a beam of short sound waves was markedly heated, and small insects and aquatic animals perished after a few seconds under the effect of these waves.

The well-known phenomenon of detonation in explosion is also related to these waves.

The practical applications of the ultrasonic waves are quite interesting. An ultrasonic beacon has been recently opened in Calais (France). Quartz immersed in seawater is used. It generates frequencies of 20,000 cycles per second, which propagate in all directions and are picked up by special quartz receivers on board ships.

The continuation of Goldman's experiments on the effect of the "lethal sound" on living organisms will lead to many new discoveries, no less
47 remarkable than the previously observed effect of ultrashort electromagnetic waves (radium gamma rays and X-rays) on diseased tissues (cancerous foci) in the human organism.

Coolidge's destruction rays

Coolidge, an American scientist famous for his research with cathode rays, succeeded in obtaining these rays in a thick beam. These rays have a highly destructive effect upon living and vegetative tissues.

Coolidge's new tube permits injecting the entire anode current of electrons through a thin (0.25 mm thick) nickel foil directly into air. The

tube current is 60 milliamperes, voltage 350. The electrical power of the electrons injected into air is about 7.5 kilowatt. Until recently, the physicists were familiar with this phenomenon only on a miniature scale, in the form of the so-called Lennard's rays. Because of the high voltage, the electrons injected into the air have a velocity equal to about 50% of the speed of light. In other words, they are comparable to the radium beta rays, which also consist of high-speed free electrons. One gram of radium emits 133.4 calories of energy each hour. Beta rays constitute only 1.8% of this amount, or 2.4 cal per hour, or 0.0028 watt. Comparing this with the power of the Coolidge tube, which is 7.5 kilowatt, we see that its effect is comparable with 2–5 tons of radium metal, the only difference being that the Coolidge tube is free from alpha and gamma rays.

The Coolidge rays hitting various objects cause spectacular phenomena. Falling on calcite, they make it give off a bright orange light. This glow is maintained for a few hours after the irradiation has stopped. Granite under the effect of these rays glows in different colors, each component giving off its own color: blue, red, green.

Acting upon gaseous acetylene, the rays cause the formation of an insoluble solid residue. These rays oxidize sugar. They kill all bacteria in less than $\frac{1}{10}$ of a second. When a rabbit's ear is exposed to these rays for $\frac{1}{10}$ of a second, the hair on the exposed spot falls off and gray hair grows back. When the exposure is more prolonged, an ulcer is formed.

In 1928 Coolidge began experimenting with voltages of 980,000. The purpose of these experiments was the conversion of some substances into others by spallation of at least some electrons from the atomic nucleus.

Boiko's heat rays

Eng. A. N. Boiko, Head of the Magnetic Laboratory of the Main Board of Weights and Measures, found a new application for the heat rays emitted
48 by an ordinary projector together with the light beam. His latest experiments showed how to start fires at a considerable distance from the projector, by concentrating the heat rays. Enemy aircraft and fixed reconnaissance balloons may be hit in the air by these rays.

Wood's burning sound

The recent experiments of Prof. Wood in the U. S. A. elucidated the amazing effect of the high-frequency mechanical vibrations (up to 300,000 cycles per second), which are much above the sonic frequencies that seldom exceed 15,000–20,000 cycles per second and become inaudible to the human ear at 40,000 cycles per second. The high-frequency sound vibrations excite mechanical vibrations in the target, which are manifested as heat and raise the temperature of the body. When these vibrations reach a certain limit, they ignite the target object, which is destroyed. In the process, the heat waves may burn the interior of various objects, while the exterior remains undamaged.

Gurvich's biological rays

Professor Ya. Frenkel provides interesting information about the so-called Gurvich's biological rays.

A few years ago, Prof. Gurvich (now working in Moscow) observed that certain parts of a plant affect at a distance other parts of the same or another plant. This effect consists of the acceleration of the process of cell division (the process which determines the growth of tissues and organisms). It takes place in those parts of the plant in which there is particularly rapid cell division, in root tips, or in yeasts, as well as in cells which have suffered some heavy damage (e. g., trituration into a viscous mass).

In Gurvich's initial experiments, this effect was observed as follows: He took two bulbs, placing them so that any one of the roots A of one bulb was directed perpendicularly to a root B of the other. It turned out that in the part of root B located opposite the tip of root A and closest to it, the rate of cell division considerably increased as compared with the norm.

49 What is the nature of the effect that, emanating from the tip of the root A, accelerates the processes of cell division in root B? The most obvious answer is that there are a special kind of "biological rays" emitted by the tip of root A (and so by the tips of all roots). Although causing a "biological" effect, these rays may be of a purely physical nature like the rays emitted by some other physical sources. It is known, for instance, that ultraviolet rays cause a pronounced biological effect. The now popular tuberculosis treatment by quartz lamps is based on this effect. Professor Gurvich soon came to the conclusion that biological or mitogenetic rays discovered by him are no different from the ordinary ultraviolet rays; when a quartz plate is interposed between the tip root A and root B the observed effect is hardly affected, whereas a glass plate totally eliminates the effect.

Further, these rays are reflected from glass in the same way as ordinary rays. In other words, the tips of the roots behave like small ultraviolet lamps, or like "glowworms," differing from the latter only in the wavelength of the emitted light.

In order to confirm his conclusions, Prof. Gurvich studied the ultraviolet rays emitted in the discharge between aluminum electrodes (their wavelength is between 4,000 and 2,000 Å),* from the point of view of their effect upon the rate of cell division. In this case the anticipated effect was even more pronounced than when using biological sources. Then Gurvich's assistant, G. M. Frank, together with E. P. Khalfin, at the A. F. Ioffe Leningrad Physico-technical Institute, studied the effect of rays emitted by biological sources (onion roots and, particularly, yeast) upon physical objects. The presence of the ultraviolet rays was confirmed without a shadow of a doubt.

Professor Gurvich's work enjoys wide popularity among biologists abroad, whereas physicists, until recently, were totally unfamiliar with his results. About a year ago, during the Soviet Science week in Berlin, Professor Gurvich read a lecture about his works. The lecture was attended by representatives of the German physicists, in particular from the Siemens research laboratory. This is what Professor Ioffe tells about the outcome of Gurvich's lecture.

* The visible spectrum lies between 7,000 and 4,000 Å.

The Siemens laboratory immediately conducted exact experiments to establish what part of the ultraviolet spectrum particularly accelerates the cell division process.

It turned out that this band is extremely narrow, virtually amounting to a single "line" with the wavelength of about 3,400 Å. It further turned out, and this result is especially remarkable, that beside rays producing a beneficial effect there are rays which inhibit cell division. The wave-
50 length of these inhibiting rays is about 3,130 Å. They can be easily suppressed if the so-called uviol glass is substituted for quartz as the lamp envelope. This uviol glass transmits the beneficial rays and totally absorbs, as opposed to quartz, the rays with shorter wavelengths. The maximum effect is obtained if an electric spark between silver electrodes is used as a light source.

Further research at the Siemens laboratory proved that Gurvich's "mitogenetic rays" isolated in this way are of universal biological value, i. e., they accelerate the cell division processes in all plant and animal tissues.* Specifically, they have a drastic effect on the integumentary tissues of man and animals. Here are a few striking examples. The X-rays, as we know, cause heavy burns that develop into unhealing ulcers. After a brief exposure to "mitogenetic rays" of the Siemens silver (or uviol) lamp, mice dying from these ulcers were soon cured. A boy suffering from bone tuberculosis had undergone a leg operation a few years earlier, but in spite of all efforts the wound did not cicatrize. Treatment with "mitogenetic ray" caused the wound to heal quickly. The rays have a rapid healing effect in case of lupus (skin tuberculosis). Note, however, that these effects probably are not due to the mitogenetic activity of the rays (since far from all the cells of the body are affected in this way).

In the above cases the main factor is probably the suppression of the harmful ultraviolet rays by the uviol glass (these rays are then emitted in large quantities by ordinary quartz lamps). According to A. F. Ioffe, Germany has begun using the new "uvioi" lamps on a large scale for curative purposes. Gurvich's mitogenetic rays thus open a new era in the history of medicine. It is quite possible that in the near future they (or their antagonists — the inhibiting rays) will find their place in the treatment of malignant tumors. Professor Gurvich has already established that the cells of such tumors (cancer, sarcoma) are a very strong source of mitogenetic rays.

Setting aside these wonderful practical perspectives, let me note in conclusion a few features characterizing the theoretical significance of the above results for biology.

First, they prove the unusual unity of the whole organic world. Indeed, all the living cells, from amoeba to human cells, react by faster division to
51 the same rays, which they themselves emit under certain conditions.

It further turned out that the interaction between various cells of a complex organism is carried out not only by means of the circulatory and nervous systems but also directly "at a distance." The communication between various cells or organs through blood has repeatedly been compared with

* Unfertilized embryos immediately begin to divide when exposed to mitogenetic rays, i. e., they develop parthogenetically.

the postal communications in our society. The analogy between the interaction through the nervous system and the telegraph is obvious and generally known. It now seems that the function of the biological postal services includes also communication "by radio."

Bard's invisible rays for anti-aircraft defense

The Englishman Bard constructed a projector emitting invisible infra-red rays. They are aimed at an object which is invisible to the naked eye (for example, an airplane in clouds or in fog); when the beam intercepts the object, its image is reflected in a special mirror.

Remote energy transmission

Speaking of remote energy transmission, one should mention Marconi's famous experiment on 26 March 1930. He turned on 3,000 electric bulbs in the town hall in Sydney, Australia, from a floating laboratory 18,000 km distant from Sydney.

Marconi, however, did not transmit the actual energy required for this effect; he only actuated by means of radio waves a special relay in Sydney, connected with the switch that turned on the current of the local power station.

"The strangest" in new physics

An article under this title was published by P. Hale, a professor of physics in the U. S. A. The author describes the contemporary views on the laws of conservation of matter and energy.

He acknowledges that at present the law of the conservation of energy is considered only approximately true. According to the contemporary physical theory, any loss of energy involves a proportional loss of matter. It seems as though energy itself has a certain mass which is lost when energy disappears. This mass equivalent of energy should be looked upon much in the same way as one looks upon the heat equivalent of a given amount of energy. One gram of mass equivalent, however, corresponds to many more units of energy than 1 calorie of heat. Only 4.2×10^7 ergs of
52 work are required to create one calorie of heat, whereas the equivalent of one gram of matter is not less than 9×10^{20} (approximately twenty quintillion times more) ergs. The Sun, for example, loses four million tons of matter per second through radiation.

Einstein was the first to formulate the equivalence of matter and energy, as a mathematical corollary of his theory of relativity.

Experiments with radiation pressure show that the light energy manifests itself exactly as if it had a small mass. Likewise, radiant heat should have a certain mass. As a further development of this concept, it should be

acknowledged that if the radiation objects lose mass, objects which absorb energy (e.g., being heated) gain additional mass. Loads lifted to a certain altitude above the Earth's surface should have a greater mass than the same loads on the surface.

Thus, "the strangest" in modern physics is the fact that the old concept of the conservation of matter can no longer be considered strictly scientific. Matter disappears in order to be restored as energy, and vice versa. Matter and energy should be looked upon as different variants or particular cases of a new and wider concept, for which no name has been found as yet.

*INTERPLANETARY SIGNALS AND COMMUNICATION
IN SCIENCE*

"And hungrily from the bottom of the
atmosphere,
In the darkness of planetary nights,
A million eyes again
Will turn to the upper spheres."

V. Morozov, "Songs of the Stars."

"Living thoughts are the shadows
created by our mind and brought to
life by its radiant energy."

V. Kryzhanovskaya, "In the Kingdom of
Evil."

For a long time people have been preoccupied with the idea of signal transmission from Earth to other planets, mainly to Mars. The idea also suggested itself for purposes of communication with interplanetary ships sent from Earth.

Several methods of establishing such communication were suggested:

1. Optical communication by means of high-power telescopes.
2. Communication by means of light rays, exploiting reflection of solar rays during the day and applying a powerful electric light source at night.
3. Radio signals.
4. Communication by telephone.

The difference between the light and radio signals lies in the nature of their waves: in radio signals the wave frequencies range from 10^3 to 10^7 cycles per second, whereas in optical transmission the frequencies range from 400 to 800 trillion cycles per second.

This chapter is devoted to the description of various communication methods proposed by science-fiction writers.

1. OPTICAL COMMUNICATION BY MEANS OF TELESCOPES

Fabricius' telescope

Back in the seventeenth century, one David Fabricius affirmed that with his own eyes he managed to see Selenites (inhabitants of the Moon).

Jules Verne, who mentions this report (J. Verne, "De la Terre à la Lune," pp. 14-15 [Russian edition]), does not indicate by what method Fabricius saw the Selenites.

54 The Rosicrucian magnifying glass

In 1750, in Paris, an anonymous work, "The Description of Mercury," appeared. In this book the author said that once, while taking a walk in the suburbs, he was approached by a stranger, who turned out to be a Rosicrucian* holding a high office. He suggested that the author should look through a small "philosophical" magnifying glass. The author, to his great surprise, saw with the aid of this glass the planet Mercury in all its detail. It is his impressions of what he saw that the author describes in the book.

John Herschel's telescope

Around 1835, a small pamphlet reprinted from the "New York American" reported that the famous scientist and astronomer, Sir John Herschel, who had been sent to the Cape of Good Hope for astronomical observations, had viewed the Moon from the distance of 80 yards or 73 meters (1 yard = 0.96 meter) through a telescope 24 feet in diameter with internal illumination, of his own improved design. At such a short distance, he clearly saw on the Moon caves with hippopotami, green mountains touched up with gold lace, sheep with ivory horns, white goats, and inhabitants with webbed bat-like wings. This pamphlet was written by the American Locke and enjoyed extreme popularity. Later, though, it was recognized as mere science fiction.

Branican's telescope

Jules Verne, in his novel "De la Terre à la Lune," describes the flight of three travelers in a cannonball hurled towards the Moon from a cannon. To observe the cannonball, an enormous reflector-telescope was built in the Rocky Mountains in America on top of Longs Peak (Colorado). Its length was 85.34 meters and the diameter 4.87 meters. The image of the cannonball resting on the Moon was about 3 meters in diameter, since the telescope magnified 48,000-fold and brought the moon to a distance of 8 km. Had Bengal light been provided in the cannonball, the flash during the Moon landing could also have been observed through the telescope.

* [Secret mystic-religious Masonic societies organized in the 17th and 18th centuries in Germany, Russia, the Netherlands, and some other countries. The name was probably derived either from the legendary initiator of this society, Christian Rosenkreutz, or from their emblems, the Rose and the Cross.]

Arel'skii's telescope

G. Arel'skii, in his "Povesti o Marse" (Stories about Mars), describes a telescope through which it is possible to discern not only the cities on Mars but also the Martians themselves.

55 Using a special combination of lenses, he substituted almost microscopic reflectors for the huge contemporary telescopes of the same magnifying power. Then, applying an old principle, he increased the focal length of his refractor and in this way achieved incredible magnifications.

The refractor had to be perfectly stationary for accurate observations. Therefore, the conventional telescope tube was eliminated and replaced by a huge cylindrical tunnel cut through rocks at an angle to the celestial axis. Systems of objectives and oculars were attached at the tunnel opening. Before the main objective, a rotating prismatic receiver of light rays was placed.

By means of this receiver, with the refractor stationary, it was possible to form the image of any object with the objective of the telescope.

Kryzhanovskaya's telescope

V. Kryzhanovskaya, in her novel "Na sosednei planete" (On the Neighboring Planet), describes a telescope through which it is possible to discern from Mars such details on Earth as the Eiffel Tower.

The telescope objectives were made of oxygen. Oxygen is a magnetic element and in the liquid state it is attracted like iron filings, for example. A tube was built and magnetized by means of a thin wire wound around its end. Gas particles repel each other, and the oxygen molecules in the tube were moreover attracted to the magnetic ring, so that the gas density of the center was lower than at the periphery. In this way a perfect objective was obtained.

The superiority of this objective was due to two reasons: first, the oxygen particles under these conditions were distributed according to a strict mathematical law, secondly the size of such oxygen lenses, unlike the glass lenses, was not limited and they could reach up to 15 m in diameter.

Bogdanov's telescope

It is about 2 m long, with a diamond objective and 600-fold magnification; photographic magnification can be as high as 60,000. People are discernible on photographs taken with this telescope from a distance of 2,000 km.

Uminski's telescope

Władysław Umiński in his "Niewiedomyj mir" (The Unknown World), describes a telescope built in Boston in 1890 at the order of the millionaire Brighton and the astronomer Harting. The purpose of the telescope was to observe Mars and detect the signals which the Martians, if they existed, would send to Earth in answer to the signal sent by Brighton and Harting from Earth on 12 October 1892. Their signal consisted of a cross comprising nine luminous spots of 40 million candles each. The telescope was built and installed in the Sierra Madre Mountains near the Pacific Ocean at an altitude of 2,500 m. The diameter of its objective was 2 m and its length 30 m.

In 1894, the observers noticed through the telescope a large spot on Mars, but no one could decide whether or not it was in response to their signal.

Astor's telescope

The English writer Astor, in his novel "Journey in Other Worlds," describes telescopes of the future in the following way: "The glass mirrors are convex and highly polished, 20 m in diameter; during observations electricity plays an important supporting role to light."

Tsiolkovskii's telescope

Without gravitation, the molecular forces are particularly prominent in liquids, which under the influence of solids may assume an interesting and endless variety of unusual forms. For example, water or oil may be shaped into biconcave and biconvex lenses that will replace the glass lenses of optical instruments. It is even possible to build sophisticated telescopes and microscopes using wire frame and liquid lenses.

Charles Winn's telescope

The English writer Charles Winn, in his novel "The Endless Vision" (1924), describes a new telescope through which one can see people on Mars. The telescope is located on the top of the Andes in South America.

At the observatory, in the middle of a room, a massive mercury reflector supported on a heavy equatorial mounting rotates with the uniformity and precision of a chronometer. The mercury is hard as steel. Above this room, at the very top of the observatory dome another room is located, with cathode tubes on one side and a huge control board with many knobs, rheostats and switches on the other. In the middle of this room, above the floor, there is a shiny silver screen of 6 sq. feet. One can see in this screen a reflection of a strange apparatus aimed at it straight from the ceiling. Above the dome apex there is an apparatus resembling a huge X-ray tube. To observe a star, the lower reflector is aimed first. It focuses the rays above a special tube near the ceiling of the top room. This tube constitutes

the main component of the telescope. It contains a composition of a previously unknown element, called lucium, which has the same properties as selenium but is a million times more photosensitive. In perfect darkness, it does not conduct electricity at all, but as soon as the weakest of rays hits it — be it a ray which passed through the entire universe — the element immediately acquires conductivity, which is directly proportional to the incident power. The ray from the reflector reaching the focus of this tube is transformed into electrical oscillations whose voltage is amplified and which are then again transformed into light, producing an image on the screen. Furthermore, when observing a star, a special "scattering ray" is directed towards the target, creating waves of the higher spectra which eliminate all foreign substances from the ray path. The path length of this ray in the atmosphere is about 1,000 km, and since the telescope is directed along the ray path, the observations are not influenced by atmospheric meteors, which thus cannot eclipse the star.

A telescope with a 150-m objective

Engineer G. D. Nikol'skii, in his novel "Cherez tysyachu let" (In a Thousand Years), describes how people in the thirtieth century designed an artificial planet-ship circling the Earth as its satellite. Inside the ship was a telescope with an objective 150 m in diameter. This telescope automatically preserved its orientation relative to the stars, and the planet-ship itself was spinning on its axis.

Optical communication with Mars according to Wells

The English writer Herbert G. Wells, in his short story "The Crystal Egg," describes the following method of optical communication with Mars.

A certain antiquary in London came across a beautifully polished egg-shaped piece of crystal. The antiquary, by the name of Cave, noticed that the egg possessed very strange properties. A thin ray of light falling on the egg seemed to fill its interior in such a way that it did not agree with the owner's understanding of the laws of physics. The light did not remain steady, but moved through the egg as if it were a solid sphere of luminous vapor. When transferred to a dark part of the room, the egg continued to shine for four or five minutes.

When turned at a certain angle to a ray of light, the egg seemed to present Cave with a view of open country. This impression was the strongest when the angle between the line of vision and the ray of light was 137° .

58 The picture changed and the objects moved as the angle between the ray and the line of vision was varied. He saw mountains, cities, red grass, flying figures; masts installed near the houses carried crystal eggs on their top, exactly like his own.

Cave saw a winged creature approach one of the masts and look into the egg. Suddenly, the creature's face appeared before him, as though it were on the other side of his own egg. Wanting to check his impression, he moved his head to see whether there really was something behind his egg, but the illusion immediately disappeared and the luminous crystal dimmed.

During further observations, Cave noticed two "moons" in the sky of this "world". He was finally convinced that the planet was Mars.

Cave died during one of these observation sessions and the egg was bought by a stranger.

The author suggests at the end that the crystal on top of the mast on Mars and Mr. Cave's crystal egg were somehow and yet inexplicably related and that the egg was sent from Mars to Earth (possibly in the remote past with the purpose of allowing the Martians to acquaint themselves closer with our affairs). The counterparts of other crystals on Mars were possibly elsewhere in the world.

Kinetaphone on Mars

The film "Aelita" produced by "Mezhrabpom Rus'" (Moscow) in 1927 dealt with an imaginary flight (in a dream) to Mars by people from Earth. According to this film, in an astronomical tower on Mars there is an apparatus — a kinetaphone — which makes possible the observation of life on various planets. When the observer brings his eye close to the ocular and turns a lever, views of another planet appear before him.

Flying observatories

Hans Dominik, in his novel "Das Erbe der Uraniden," describes two flying astronomical observatories located at an altitude of 15 km above the Earth, one over Greenwich in England and the other over Berlin. The observatories are maintained stationary in the air by means of powerful helicopters. Observations were made through telescopes with 20,000-fold magnification.

Gail's telescope.

Otto Gail, in his novel "Hans Hardts Mondfahrt," describes a gigantic telescope by means of which passengers on an interplanetary rocket-ship can observe various features of the Moon and the Earth during the trip to the Moon.

59 A concave silver-plated tin mirror, a few meters in diameter, is held on metal cables a few hundred meters outside the rocket. The mirror image is intercepted by a special ocular in the captain's quarters. The mirror may be moved and set in any desired position by special cables. The telescope magnifies many thousand times; through it one may see the contours of the continents and even the tall buildings in large cities.

The observation points rapidly move across the field of vision of the telescope due to the rotation of the Earth. Therefore, special skill is required to catch any particular object and to aim the telescope in the desired direction by means of the cables.

This telescope design is possible due to the weightlessness of the mirror during the free flight of the rocket in interplanetary space.

Hermann Noordung's space observatory

The desire to probe the upper strata of the atmosphere, to solve the mystery of the Heaviside layer that supposedly shrouds the Earth at an altitude of about 200 km and does not transmit radio waves, and, finally, the problem of interplanetary flights progressively emerge as a major occupation of scientists and engineers. The desire to investigate the nature of cosmic rays and their properties attracts the attention of numerous researchers.

(60)



FIGURE 17. Noordung's space station

Various projects for achieving high flight altitudes also appeared. The authors of such projects mainly suggest rocket-propelled spaceships for this purpose. They are either automatic, unmanned, and equipped only with recording instruments, or possibly manned. The automatic spacecraft include Lademann's automatic radio-rocket, Hoefft's and Goddard's rockets and others, whereas projects for manned rockets have been proposed by Oberth, Hohmann, Valier, Tsiolkovskii, Goddard, and others.

Many scientists also proposed to establish an observatory in outer space at a distance from Earth from which it would be possible to conduct various observations. The idea of such "artificial planets or islands" in the cosmic ocean was proposed by Laffert, Tsiolkovskii, Nikol'skii and others. According to the authors of these projects, the building material for the construction of the space stations will be brought from Earth by means of rockets. Men in space suits will assemble the parts into one whole, and a sufficient velocity will be imparted by rockets to the structure which will revolve around the Earth as a satellite. The staff remaining on such satellites will conduct the necessary observations.

One of the latest projects for setting up such a space station was proposed by the German engineer Herman Noordung. It was published in Germany in 1929 in a special book.

The purpose of this station is to study the nature of the cosmic rays and to conduct astronomical observations. The station is transported by spaceships (rockets) from Earth into outer space and is stabilized above the equator at the altitude of 35,900 km. At this altitude, if the station's angular velocity around the Earth's axis is the same as the Earth's angular velocity,

the centrifugal force acting on the station balances the gravitational attraction of the Earth and the station remains in orbit without falling to Earth. The corresponding linear velocity has to be 3,080 m per sec.

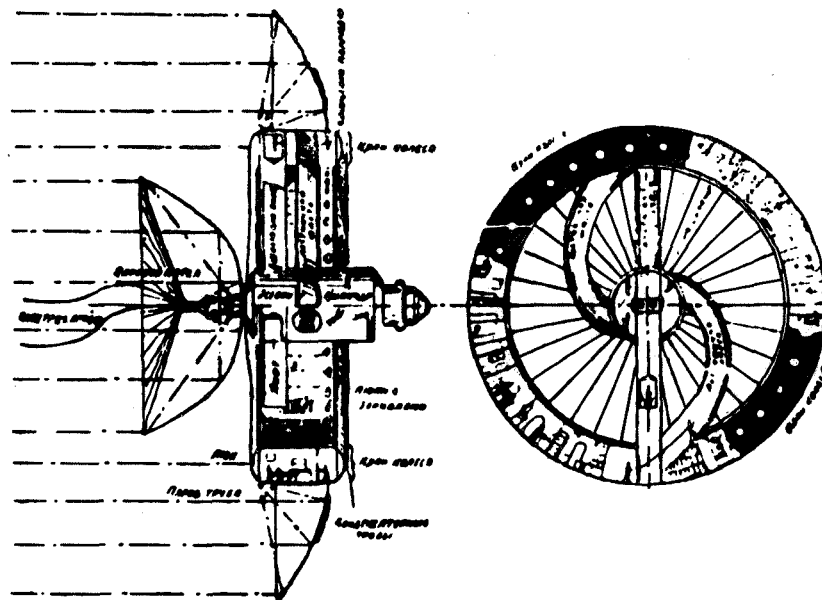

FIGURE 18. Noordung's living wheel (cross-section)
[Note: Russian text in the illustration is illegible.]

The entire station consists of three parts: 1) the living wheel; 2) the observatory; and 3) the engine station. In Figure 17 they are viewed as if from the window of a rocket shuttling between the station and the Earth which is seen at a distance.

1) The living wheel (Figures 18 and 19). The main significance of its construction is to allow the staff to experience the sensation of weight as on Earth. For this purpose, the wheel should rotate around its axis, driven by special motors. If the wheel diameter is 30 cm and it completes one revolution in 8 sec, the centrifugal acceleration is equal to that on the Earth, thus creating the required sensation of weight. Without this arrangement, people in the wheel drifting in a free flight around the Earth would be weightless, experiencing a number of unusual and probably painful sensations. Furthermore, additional instruments and mechanisms would be required for sustaining life in the wheel.

61 Thus, the wheel rotates around its axis. Living quarters are arranged along the circumference from which two staircases, built almost according to a logarithmic spiral, lead to the center. There is no gravitation at the center and people can fly in the air by pushing off from the walls. An elevator runs along one of the diameters. At one end of the cylinder near the axis an exit air lock is provided. At the other end there is a thermal assembly consisting of a boiler filled with water. The radiant power

of the solar rays reflected from the parabolic reflector surrounding the boiler turns the water into steam, which drives the generators supplying

electric current and thus actuates the electromotors which spin the wheel and serve for various other purposes. From the end of the wheel's axis, near the reflector's focus, wires stretch to the engine station located at a distance from the wheel. To prevent the wires from winding up during the rotation of the wheel, the end of the wheel axis to which the wires are attached is rotated by a special motor in the opposite direction.

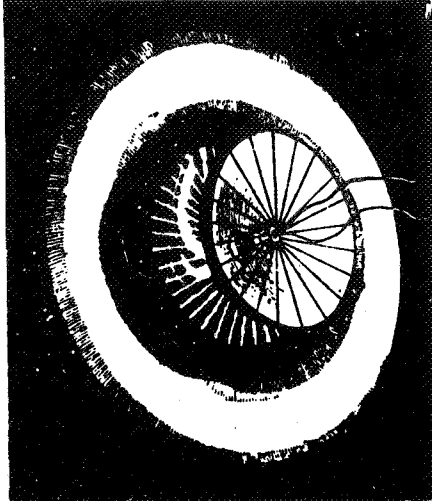

FIGURE 19. Noordung's living wheel (general view)

Besides the boiler reflector, there is another large reflector, around the wheel, reflecting the solar rays onto the annular pipe boiler filled with water which encircles the wheel. The spent steam cools off in condensators behind the reflector.

2) The observatory (Figure 20). It moves around the Earth with the wheel but it does not revolve around

its axis. The air is supplied through a tube from the wheel. Spent air is removed through the tube. Heat and light are supplied by electric wires from the wheel and from the engine station.

(62)

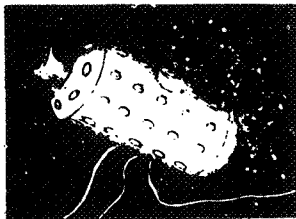

FIGURE 20. Noordung's observatory

(62)

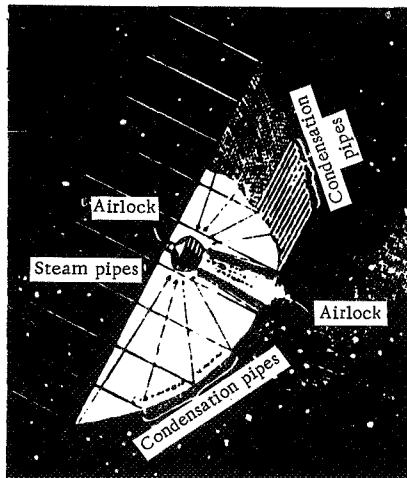

FIGURE 21. Noordung's engine station

3) The engine station (Figure 21). Its design and the boiler of the main part are similar to the parabolic mirror and the boiler near the axis of the living wheel. The figure shows the mirror, the engine compartment with two airlocks in the focus, and condensation pipes behind the mirror. This arrangement provides additional electric power which is transmitted by wires to the wheel and the observatory. Moreover, turned at an appropriate angle, the mirror can illuminate the shaded part of the observatory or send light signals to Earth. A powerful radio-station is also provided here. The wheel, the observatory, and the engine unit are
62 located from 100 to 1,000 m from each other, depending on the actual requirements. People in space suits with small rocket propulsion engines can move between the different units of the assembly.

Of course, we are still far from being able to build such an observatory, since we first have to learn to take off from Earth, pierce the armor of gravitation and the atmosphere, build a rocket and learn to operate it. However, the efforts of numerous scientists and engineers in this direction will finally provide man with the means of separating from Earth and escaping beyond its atmosphere. Then, probably, space observatories, not unlike those described by Noordung, will become reality.

2. COMMUNICATION BY MEANS OF LIGHT RAYS

Interplanetary signals according to Gauss

C. Flammarion, in his work "La Pluralité des Mondes Habités," describes the following method of interplanetary communication.

In the astronomy course given in the Paris Observatory fifty years ago, Arago described an original project proposed by the German mathematician Gauss, who in the nineteenth century advanced the idea of sending optical signals to the inhabitants of the Moon; if the Moon is inhabited by sufficiently developed intelligent beings, they should be able to understand the signals sent from Earth.

Gauss suggested forming a geometrical image of the Pythagorean theorem on Earth from plants, as a universally understood signal. Another method of signal transmission may be realized by means of mirrors in a certain arrangement reflecting the light to the Moon with a fixed succession of light and dark intervals.

In Gauss's opinion, anyone familiar with the rudiments of mathematics
63 could easily comprehend the scientific significance of the square of the hypotenuse of a right triangle, presented in the above manner. If the Selenites really existed and were familiar with geometry, they would definitely reciprocate with a similar figure. Thus, contact would be established between the Earth and the Moon and it would not be hard to devise an alphabet enabling us to communicate with the inhabitants of the Moon.

Similar endeavors were reported in 1899 for sending heliograms to Mars.*

Littrow's optical telegraph

Around 1840, the astronomer Littrow advanced an idea of signal transmission from Earth to the Moon. He suggested that a triangle, a square, or a circle should be constructed on Earth in the middle of an open plain. It should consist of luminous spots, for which purpose the reflection of Sun rays by means of mirrors could be used in daytime and electric light at night. Such geometrical figures would be noticed by the Moon astronomers, assuming that they existed and had optical instruments of the same power as our telescopes. A similar method of communication could be applied to Mars, but the signal figures would have to be enlarged tenfold, extending over hundreds, and not tens of kilometers.

Optical signals to Mars according to Umiński

Władysław Umiński, in his story "The Unknown World," describes the following method of signal transmission from Earth to Mars.

The American millionaire Brighton and the astronomer Harting from Boston decided to establish contact with Mars by means of optical signals. They arranged in Ecuador, 130 km southeast of its capital Quito, a figure in

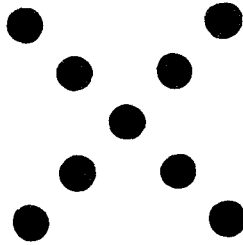

FIGURE 22. Optical signals to Mars

the shape of a cross consisting of nine luminous spots (Figure 22). The distance between the spots was 60 km. To obtain the required brightness, the ground in each of the nine spots located on a hill was covered with powder of magnesia and thus served as a reflector. Fire resulted from igniting 250 tons of a mixture of aluminum powder and fat, distributed in 500 crates and arranged in 5 concentric circles. The diameter of the outside circle was 200 m. The mixture was ignited electrically through a fuse of potassium chloride and sulfur; saltpeter and wax were also used. At the time of ignition of the nine spots, Mars was

64

closest to Earth (56 million km), so if Mars were inhabited the Martian astronomers would see this star unit clearly, as it shone for 5 hrs on the night surface of the Earth (12 October, 1892 from 9 p.m. to 2 a.m.) The luminous power of each spot reached 40 million candles.

The author states that the weather was favorable and the wind drove the smoke away. However, no reciprocal signal followed.

* Historical reference to the projects of signals to Mars: In 1892, on August 6th Galton in "The Times," and on August 18th Hawes in "The Pall Mall Gazette" proposed to establish relations with the inhabitants of Mars by means of optical signals.

Signals according to Astor

The English writer J. J. Astor, in his novel "Journey in Other Worlds," describes the following method of signal transmission from Earth into interplanetary space to communicate with a spaceship traveling to Jupiter.

"Exactly at midnight, a weak phosphorescent light, like the glow of a firefly, appeared in the region of Greenland on the Earth we had recently left. The light gradually grew stronger until it glowed like a long white beam cast by a lighthouse. In this beam we recognized the effect of the most powerful electric current ever generated by man. For a few moments, all the electricity produced by generators at the Niagara Falls and in the Bay of Fundy, and by steam engines and other power sources in the Northern Hemisphere concentrated in this light source. The beam grew brighter for one minute and then it clearly transmitted a few words with fixed intervals between them. Upon receiving this message from Earth, the travelers, using their signal flashlight, sent a reciprocal signal which was picked up by the astronomers on Earth through their telescopes."

Optical signals from a rocket to Earth

Max Valier, in his story "Auf kühner Fahrt zum Mars" (Breslau, 1928), describes three German travelers returning in a rocket from outer space to Earth. They sent the news of their return using the light of three electric projectors located on the outside of the rocket. Previously they were contacted from Berlin (Tempelhof) by means of 400 powerful projectors.

Optical signals from Earth to outer space

O. W. Gail, in his novel "Hans Hardts Mondfahrt" (Breslau, 1928), describes how his heroes returning in a rocket from the Moon detected signals from Earth. In the Alps, around the Bodensee [Lake Constance], numerous projectors were set up that sent light signals in Morse code and notified the travelers that their return had been noticed and all were ready to offer help.

65 Signals from Mars

The Journal "Priroda i Lyudi," No. 10, 1901, cites a report from the daily "Nouvelles Temps" (by "Matin") on signals from Mars.

The director of the Flagstaff Observatory in the State of Oregon, Mr. Douglas, on 8 December (1900?) observed through a telescope the so-called "Sea of Icarus" on Mars and was astonished by the following strange fact: he suddenly noticed a string of bright lights arranged in a straight line, extending over a few hundred kilometers. These gigantic lights

burned for an hour and ten minutes and then disappeared as suddenly as they had appeared. This straight-line arrangement seemed to indicate a voluntary intelligent action and the simultaneity of their appearance and disappearance confirmed this opinion.

Interplanetary signals according to Tsiolkovskii

In 1896 the "Kaluzhskii Vestnik" (The Kaluga Herald) (No.68) carried a scientific article by K. Tsiolkovskii entitled "Can the Earth Ever Inform the Inhabitants of Other Planets about the Existence of Intelligent Beings on It?"

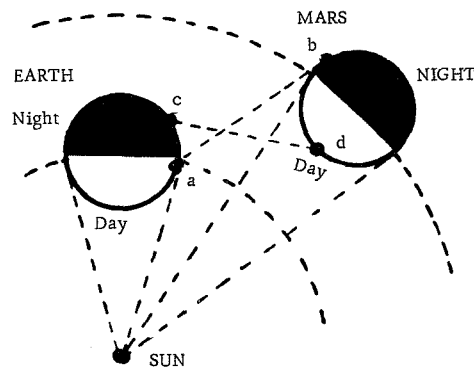

FIGURE 23. Signals to Mars according to Tsiolkovskii

In this article, the author mentions a number of ideas on the possibility of establishing contact with the inhabitants of Mars by means of light signals. In view of the fact that these ideas are probably the first to be expressed in Russia on the subject, we reproduce the article in full, with the diagram (Figure 23) drawn by K. Tsiolkovskii in pencil on the margin of the newspaper sent to us by him.

"One of the recent issues of "The Kaluga Herald" carried a report (from "Figaro Illustrée") of regular geometrical figures observed on Mars (a reddish planet well visible from Earth). These figures clearly point to the existence of man-like intelligent beings on Mars.

Photographs examined through a microscope recorded the following objects: a circle with two perpendicular diameters, an ellipse (oval), and a parabola (another quadratic). I do not take upon myself to confirm the authenticity of these surprising reports. I shall only note that the inhabitants of Earth are far from being able to arrange figures that would be visible from Mars.

66 I hope, however, that the time is near when man will be able to let his celestial neighbors learn of his existence, perhaps in other, simpler ways.

Under favorable conditions the tiny satellites of Mars (Phobos and Deimos) are readily visible from the Lick Observatory.

Pickering is of the opinion that they are 10 km in diameter. In spite of their small surface area and the tremendous distance involved (some 150 million miles) they are visible from Earth. It follows that the same surface area of Mars should be observable through telescopes.

Let us picture ourselves in Russia, in spring, on the black, newly plowed fields.

Let 1 sq mile of these fields be covered with rotary shields which either reflect to Mars the solar rays from their white shiny surface or turn their opposite black side to the planet. Since these shields reflect the solar rays better than the natural soil of the Mars satellites, since their illumination by the Sun is twice as strong (Earth being closer to the Sun), and since they are aimed so as to reflect the light directly to Mars, it is possible to state with certainty that our white square field against the black background will be visible to the Martians not less clearly than we see their poorly illuminated tiny satellites. Maneuvering the shields so that from Mars they appear like one shiny spot, we would be able to inform the Martians of our existence and our civilization.

Let us imagine, for example, that exactly every 10 sec the shields turn to face Mars for 2 sec with their shiny side.

The Martians viewing the Earth through their telescopes see a bright spot, which appears on Earth every 10 sec and then disappears without trace. Will they not interpret it as an attempt on the part of intelligent beings to establish contact with other intelligences?

Another maneuver is to convince the Martians of our ability to count: the shields flash once, then twice, three times, etc., preserving fixed intervals of 10 sec between the successive groups of flashes.

In a similar way we could demonstrate to our neighbors our knowledge of arithmetic: show them, for example, our ability to multiply, divide, extract the square root, etc. Our familiarity with various curves could be demonstrated by number sequences. Thus the parabola would be represented as the numerical sequence 1, 4, 9, 16, 25... We could also show our astronomical knowledge, such as the ratio of planet volumes. Thus, flashing the shields 50 times, we would show them the Earth/Moon volume ratio (which they probably know). We should start our relationship using objects and concepts familiar to the Martians, such as astronomical and physical data. Numerical sequences could even be used to transmit to the Martians various shapes, the shape of a dog, man, automobile, etc. Indeed, if they, 67 like we, are at least slightly familiar with analytical geometry, they would easily understand these numbers as the distances of points on the sought or transmitted figure from a straight line (the X-axis), divided into an equal number of parts. Connecting the points by a smooth curve, they would obtain the figure.

Integers and fractional numbers may be transmitted by longer or shorter flashes of the shields. The dark intervals between the flashes should be of equal length. Doubtless, intelligent beings can measure time even though their chronometers may differ from ours.

It is impossible to foresee all the possibilities. Let me only say that this is a reliable and feasible method of establishing serious contact with our celestial neighbors.

The point is, though, that did they exist they would make themselves seen by shield flashing rather than by tracing a curve which is a hundred times as expensive, since to represent a line a multitude of points are required, of at least 1sq mile each.

However, it is possible that they have been, even for thousands of years, sending flashing point signals aimed at us which we have not been able to detect or to understand and so now they have decided upon a more primitive approach: to set up a constant banner in the form of curves known to intelligent beings."

Letter from a rocket to Mars

In view of the differences in the methods of communication with various planets, it is not clear to what extent they would understand us if our signals did reach them. A specimen letter proposed by the journal "Die Rakete" in 1927 could serve as a suitable example for such communication. The letter could be sent from a rocket which only approached Mars, without landing.

The editor of the magazine published two drawings that could be contained in such a letter, with appropriate legends.

The first drawing (Figure 24) represents the solar system inside the Mars orbit, with the orbits of Mercury, Venus, Earth, and Mars shown. If the Martian concept of the size ratio is the same as ours, they can surmise the meaning of the picture. The dotted line connecting the Earth with Mars will convey to the Martians the path of the rocket. Arrows indicate the direction of motion of the planets and the rocket. If Martians had interplanetary ships of their own, there would be no need for the arrows in the orbits, since the Martians would know that there had to be minimum fuel consumption during the flight, which is attainable only when the direction of the rocket motion coincides with the direction of the orbital motion of the planet. Left and right of the orbits, the straight lines show the relative distances of the inner and outer planets from the Sun.

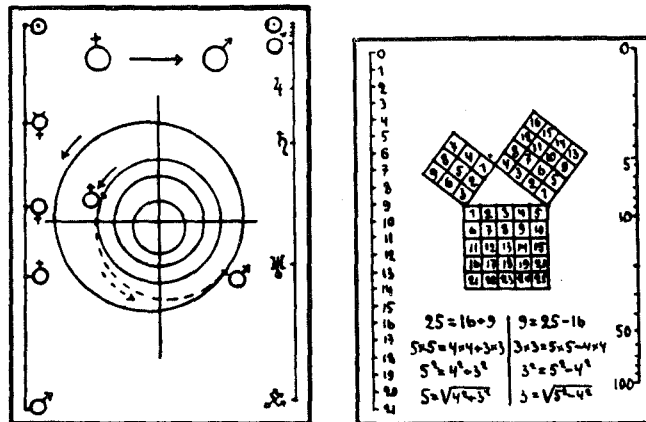

FIGURES 24 and 25. A letter to Mars

Figure 25 could convey to the Martians our knowledge of mathematics. On the left a sequence of natural numbers is shown, identified with equal-length intervals. On the right, the same numbers are shown on a logarithmic scale. In the center there is a right triangle with sides of 3, 4 and 5 and with squares on the three sides. This figure should convey to the Martians our knowledge of the Pythagorean theorem. Numbers and formulas would indicate our approach to solving the simplest problems: addition, subtraction, multiplication, raising to a power, extraction of a root, etc. Then we could send images of people, animals, plants, buildings, works of art, music, geographic maps, even seeds, small animals, etc.

Communication with Mars according to Afanas'ev

L. B. Afanas'ev, in his science-fiction story "Puteshestvie na Mars" (Journey to Mars), provides the following description of possible communication with Mars.

"The alternation of the light points on Mars is not a chance phenomenon. It is nothing other than signals from the inhabitants of the planet. Evidently, they want to speak with us. Note that the arrangement of the light spots always has a strictly regular geometric shape: first, three spots in the shape of a right triangle, then three spots along a vertical straight line, and finally one spot in the center of a disc. Here on Earth we should pay to it proper attention and repeat these signals in the same order. The inhabitants
69 of Mars will thus see that their signals are understood. By means of electricity it is possible to set up an appropriate group of spots at various points of the Earth's surface and it would even not be particularly expensive. To form a triangle, for example, we should arrange simultaneous lights in the Sahara, in the Himalayas, and on the Balkan Peninsula; for a vertical straight-line arrangement the Sahara, the Cape of Good Hope, and the Apennines could be selected... etc."

Radio signals from Mars to Earth

The English novelist F. A. Ridley, in his short story "The Green Machine," describes the impressions of a certain scientist on Earth who detected light signals from Mars.

"At about three o'clock in the morning I experienced the greatest event of my life. I had been sitting for four hours looking through a telescope at the twinkling disc of the planet. Suddenly I noticed two luminous spots on Mars' surface. They lit up at a certain distance from each other and for a moment were suspended in space like two gigantic rockets. After a short while two other such luminous spots appeared above the previous ones. Hardly controlling my excitement, my heart wildly pounding, I continued to observe the planet. Suddenly four new luminous dots flashed up and settled below the first two. Then the spots dropped onto the planet's surface and the sign disappeared from the sky. Breathless with excitement, I recoiled from the telescope. So, Mars is inhabited by intelligent beings. The Martians enunciated a universal principle, expressed by the formula $2 \times 2 = 4$.

I had made the greatest discovery in the world's history. Continuing my observations of the planet I saw the same luminous sign three nights in a row, after which the signal was discontinued."

Interplanetary electrical signals

The following project of signal transmission from Earth to Mars was published in "Mir Prikl'yucheni" (The World of Adventures) (No. 2, 1925). Consider huge lime cisterns (Figure 26) from which the rays of powerful projectors are reflected. Towers surrounded by such cisterns are constructed on a large area. Most of these cisterns if viewed from an altitude form a dotted shape of a man and an animal. The figure is planned to extend over hundreds of kilometers so it can be discerned from another planet. Alternately lighting up and then extinguishing, some of the cistern reflectors seems to animate the figure. This is a sign for other planets that there is life on Earth.

(70)

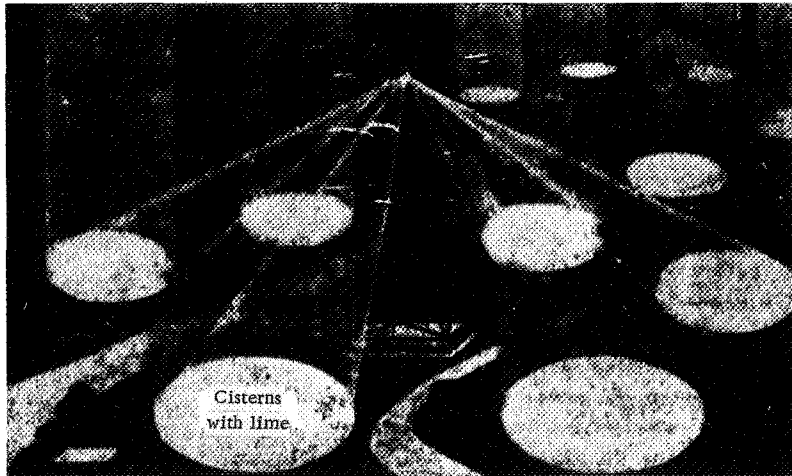

FIGURE 26. Cisterns reflecting signals to Mars

If the civilization on other planets is on the same level as ours or higher, it is natural enough to expect a reply.

Figure 27, representing the American Continent, shows what effect would be created by the luminous figures on a black background.

70 Figures 28-29 show how we achieve animation of the little figure consisting of circles. The same system is used as with moving electric advertisements, i.e., when some bulbs are extinguished, others automatically light up. This quick succession of light creates the illusion of movement. The figure with the towers shows that each tower has its own power plant but all of them are controlled by a central installation supplying all the towers with a powerful radio link.



FIGURE 27. Signals to Mars from America

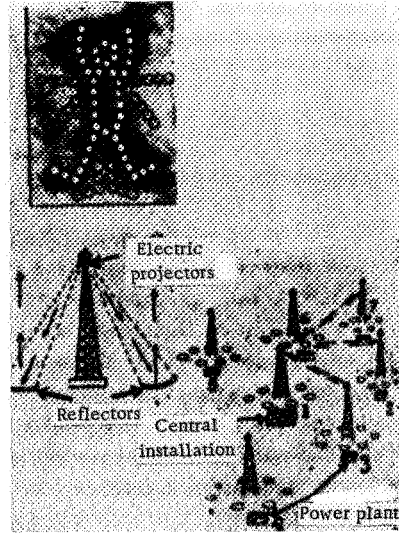

FIGURES 28-29. Details of signal transmission to Mars

71 Mirrors for Tsiolkovskii's interplanetary signals

To send messages from a rocket in space to Earth, we may use an optical telegraph using flat mirrors which reflect solar rays.

Pickering's signals from Mars

Professor W. H. Pickering from Jamaica (British West Indies) notes that each time Mars approaches Earth, certain geometric figures appear on Mars which later disappear. Back in 1877, Schiaparelli saw on Mars a circle with one diameter and in 1879 he saw in the same circle two mutually perpendicular diameters (Figure 30a), each 900 miles long. During the next approach of Mars to Earth, in 1892, canals in the shape of a regular pentagon with radii were visible in Aroquipa (Figure 30b). The center of the figure was located in Lake Ascreaus. Its diameter was 800 miles. In 1909 Dologues drew a new picture of the canals (Figure 30c). The central meridional canal was Aastrigon (1,200 miles long) (Observations des Surfaces Planétaires, 2, Plate 2). In 1924 again a new figure was observed in Elysium (Figure 30d) 1,500 miles in diameter (Publ. Astr. Soc. of the Pacific, 33, 266, 1926).

- 72 Further, Pickering suggested setting up a large projector with electric light falling onto a huge mirror almost 3,500 feet in diameter (Figure 31), so that the light reflected from the mirror would be directed straight to Mars. We can devise a "game" of light, and the Martians should be able to understand the transmitted signals.

(71)

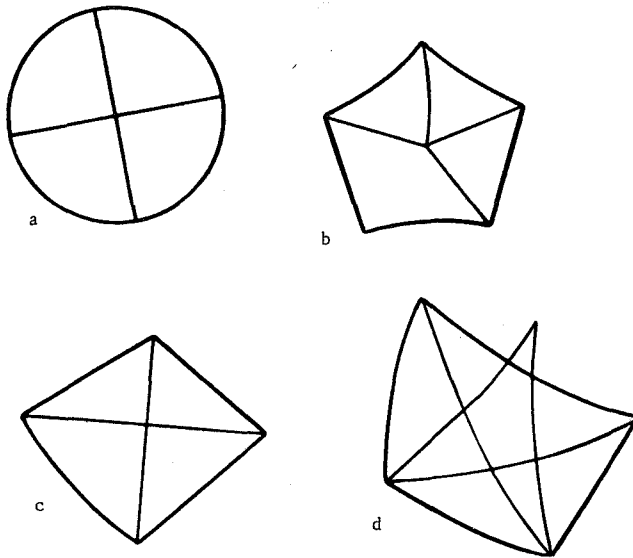

FIGURE 30. Figures on Mars according to Pickering

(72)

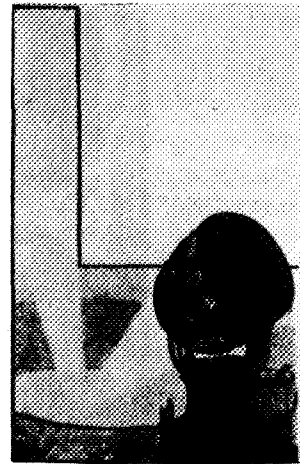

FIGURE 31. Pickering's projector

An optical telegram to Mars

In connection with Mars' approach to Earth in 1924, once again a project emerged to send from Earth to Mars an optical signal in the shape of a beam of solar rays reflected from a huge mirror on the slope of one of the Alpine peaks (Figure 32). However, the author did not account for the fact that on 22 August, when Mars would approach Earth, the latter would be between Mars and the Sun and therefore it would be impossible to send a reflected solar ray to Mars (Figure 32).

To use artificial light for the signal, its intensity should be about 73 $50 \cdot 10^{18}$ candles. For this purpose, a station a million times as powerful as all our radio stations put together would be required. Figure 32 shows one of such future projectors and next to it the figure of a man, for the sake of comparison.

Some proposed to form on Earth regular geometric figures, e.g., by planting trees in the shape of the Pythagorean theorem and making the lines 15 km thick (Figure 32₄).

(72)

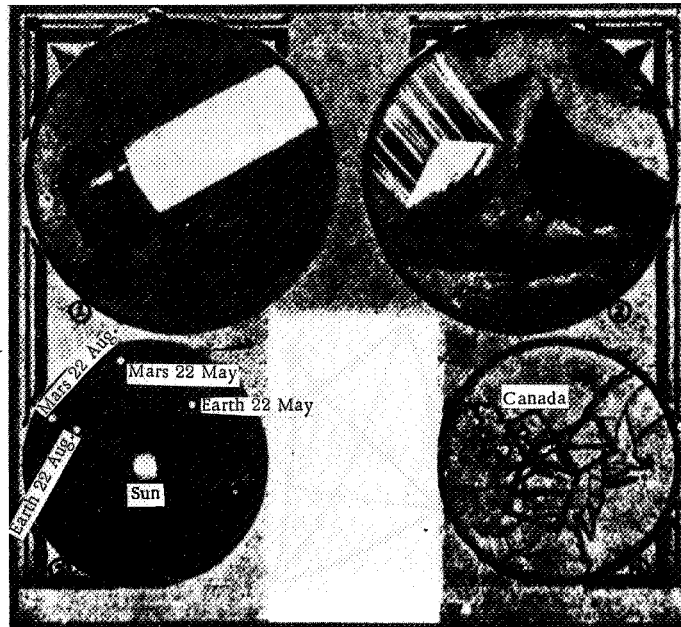

FIGURE 32. Optical signals to Mars

Light signals to Mars (according to Barnard)

Barnard, in the "Ikarus" magazine, proposed in a joking manner to arrange painted sheets of paper forming the letters of the alphabet in the African deserts. The size of each letter should be 100 miles. We sent the following question to Mars: "Why do you send us signals?" since some signals from Mars had been noticed long ago. The answer that came from Mars was: "We do not speak to you at all, we are signaling Saturn."

Audio-visual communication with Mars

Gernsback, an American, suggests aiming a very powerful ray of light at Mars and sending sounds along the ray. Having detected this ray, a Martian astronomer can pick up the sounds by special instruments. Moreover, Gernsback proposes to send from some point on the equator rays to the Moon from a radio projector. The rays reflected from the Moon may be detected by a receiver on the other side of the Earth.

The Hertz projector

The German firm of Hertz built an electric projector 2 m in diameter. Its light intensity reached 2 billion candles. The rays of this projector would appear from the Moon like a star of the sixth magnitude, i.e., they will be visible to the naked eye. The source in the projector produces a voltaic arc in an atmosphere of metallic vapor (mercury, zinc, etc.) under pressure. Its electrodes are made of carbon.

Criticism of the light signaling projects

The daytime transmission of signals to Mars by means of huge mirrors of various shapes (triangles, squares, etc.) reflecting the solar rays meets with the following objections:

- 1) these mirrors should be extremely large (tens of kilometers in diameter);
- 2) such signaling is impossible during the Earth's nearest approach to Mars, since then the light side of the Earth does not face Mars and the solar rays reflected by mirrors cannot reach Mars;
- 3) if the solar rays are to be directed at Mars when it recedes from Earth, the distance between the planets is so great that the mirrors are invisible.

74 The night-time transmission of signals meets with the following objections:

- 1) the contour of the signal figure on Earth should be about 15 km thick and hundreds of kilometers long, as otherwise it would be hard to discern from Mars even through the most powerful telescopes;
- 2) the light intensity to illuminate these figures would have to be tens of quintillions of candles and such power has not been achieved by our illumination engineers.

The astronomer E. Larkin criticizes the method of signal transmission to Mars by means of light rays on the following grounds:

- 1) if Earth is between the Sun and Mars, it is not visible from Mars;
- 2) the reflector by which we could send signals visible from Mars would have to be 836 km in diameter. Actually, supposing that Martians possess excellent telescopes, a reflector with a diameter of 42 km would suffice, but even such a reflector would cost billions. Even if it were built, the atmosphere could still make the signals invisible to the Martians.

Filming an unknown planet from a jet-propulsion vehicle (according to Levashev)

Max Valier's jet airplane and the attempts to photograph Earth from rockets constitute the subject of "K-V-1," a science-fiction novel by V. Levashev, in which the author describes the flight of an unmanned spacecraft equipped with a cinecamera to film an unknown planet and even

supplies a photograph of a city on that planet. This is how the author describes his vehicle:

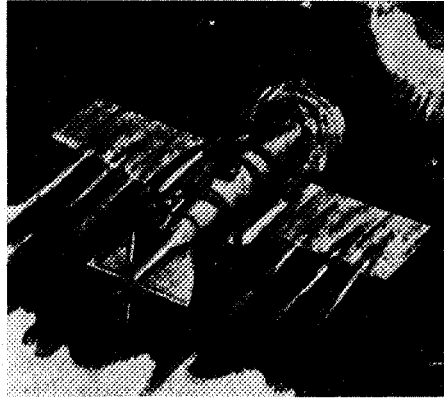

FIGURE 33. Levashev's filming spacecraft

"A small monoplane stood before us (Figure 33). The main feature of the vehicle was that it was made of wood. All around there were small round windows. The clever combination of magnifying glasses, cinecamera, and the airplane itself comprised one compact machine which, thanks to a whole system of special propellers and rudders, looked like a large amusing toy. It was named "K-V-1" (the first letters of the last names of the two heroes of the novel). The vehicle was equipped with an engine of unusual power and contained magnifying glasses a few hundred times more powerful than the
75 largest telescopes. The vehicle had to raise the payload to a tremendous altitude; it would bring any given planet closer to such a distance that the cinecamera operating in parallel with the engine would be able to photograph the surface of the planet. Then the vehicle returns to Earth to a predetermined location... The entire round trip should last 24 hours.

Further the author describes the experiment itself and the delight of the inventors after obtaining a successful film.

The Martian "retrospective"

Kurd Lasswitz, in his novel "Auf zwei Planeten," mentions a special Martian apparatus "retrospective," which collects the light waves of past events and reproduces them on a screen, like a cinema projection.

3. RADIO SIGNALS

Since radiotelegraph waves propagate like light waves, they can reach other planets from Earth when the power of the transmitter is sufficiently high.

The idea of applying radiotelegraph for such interplanetary signals was advanced by the American astronomer Todd soon after Hertz's work had been published.

Tesla, at the end of 1900, announced that he had observed mysterious electric vibrations when conducting experiments at large altitudes. He assumed that the vibrations were due to currents coming from planets and thought that it would be possible to construct an apparatus which would allow us to transmit enough energy to Mars to excite electric receivers in the form of telephone or telegraph.

The question of transmitting radio signals to other planets remains open. In 1924 it came up again and attracted general attention, although for different reasons. Our receiving radio stations often receive some odd sounds. No station on Earth transmits them and yet they come from somewhere. Many of these signals are due to electricity in the atmosphere. Occasionally we see and hear this electricity during thunderstorms in the form of thunder and lightning, but even in calm weather there is electricity in the air which affects radiotelegraph equipment. However, some of these mysterious signals somewhat differ from those created by atmospheric electricity.

76 In about 1924 Marconi expressed an idea that these signals come from another planet, probably from Mars. To verify this, he organized a few expeditions to various places in the world. They conducted all kinds of observations and measurements but found no confirmation of Marconi's assumption. Thus, the question of radiotelegraphic communication with other planets remained open.

Reports of the latest experiments and achievements of radio engineering open new perspectives for interplanetary communications. Directional radiotelegraph was discovered. The energy received by the radio station, instead of dissipating all around, is transmitted in a tight beam in the desired direction. Development of this method may make it possible to transmit a beam of electromagnetic waves of such power that it will overcome the resistance of the charged layers of the atmosphere.

Radio from Mars

The mystery of Mars' population has intrigued us for many years. That is why the report of the London lawyer Mansfield Robinson, an ardent radio-amateur, about how he received (in 1926) a radiotelegraphic signal from Mars on the day of its nearest approach to Earth, stirred up lively interest. He stated that the signal from Mars consisted only of one letter "M" received by him in Morse Code.

This report is not trustworthy and the famous French astronomer Charles Nordmann cleverly discredited Dr. Robinson's "conversation" with Mars. It is doubtful that the Martian radio is perfected to such an extent that they are able to transmit their signal to Robinson alone of all the Earth's inhabitants, he stated. Besides, it is rather doubtful that Martians should use the Morse Code, know European alphabets and, using their proximity to Earth, transmit just one letter as brotherly greetings from another world.

Mansfield Robinson, as a spiritualist, insisted that he was right and that "he had the gift of understanding what others were unable to perceive."

Mr. Robinson was not content with receiving a radio message from Mars but desired to send an answer as well.

This is how this episode is described in the "Shkval" magazine in an article entitled "Hallo, Mars!" (a true London adventure).

"On 29 October 1926, a gentleman called at a London Telegraph Office. Coming to a window, he requested to send a radiotelegram. The official took the form; the message consisted of some odd signs.

The address read:

"The Planet Mars."

77 It was signed "Mansfield Robinson." The official explained to Mr. Robinson that no radiotelegrams to Mars could be accepted as there was no information about the possibility of communication with this planet in the British Post Office regulations. Mr. Robinson, agreeing with the official's cautious attitude, insisted on sending his message.

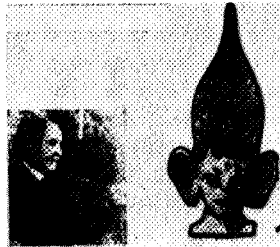

FIGURES 34 and 35. Mr. Robinson and Miss Honoruru

The official was not too bureaucratic. He made Mr. Robinson sign that he, Robinson, was informed of the lack of guarantee on the part of the Postal Authorities to deliver the radiotelegram and on the night of 29 October, when Mars was particularly close to Earth, the message was sent. No one knows whether it was received on Mars, but the next day the whole of London knew the story.

Pens and reporters got busy. Mr. Robinson, a civil servant in the Ministry of Finance in the Department of Indirect Taxation, became famous overnight. All London resounded with the shouts of newsmen:

"The greatest act of human optimism! Mr. Robinson's powerful belief! London civil servant communicates with Mars! Will Miss Honoruru answer?!!"

London papers flashed with such headlines. Mr. Robinson readily answered all the questions. He stated that he had been communicating with Mars for a long time although he was not able to furnish any signs or material evidence to this effect. But then he could provide many interesting facts from the Martian life; these details he learnt from his Martian friend Miss Honoruru (Figure 35). This Martian lady was the daughter of the director of radio communications on Mars. Robinson even painted her portrait: her features, like those of all Martians, were characterized by huge ears and a very small nose."

The pictures of Mr. Robinson and Miss Honoruru shown in Figures 34 and 35 are reproduced from "Ogonek" magazine (1926) and from "Shkval" magazine (No. 28, 1926), respectively.

In Paris, Professor Sagan sent a similar telegram. Numerous occultists and spiritualists summoned Martian spirits through media. For example, Professor Flournoy (Geneva) established rapport with Helen Schmidt who made announcements first in ancient Roman and Arabic languages, and then in some new language that the professor took to be the language of Mars.

Radio signals from Earth to Mars (according to Hans Dominik)

The German physicist and writer Hans Dominik, in his book "Im Wunderland der Technik," suggests sending radio signals to Mars which convey the length of the sides of the first Pythagorean triangles, for example 3, 4 and 5 ($3^2 + 4^2 = 5^2$). If Mars is inhabited by intelligent beings, they will reciprocate by sending signals, perhaps only in the form of numbers 5, 12, 13, expressing the length of the sides of the next triangle ($5^2 + 12^2 = 13^2$), etc.

Radio communication by visitors from a distant nebula

A. Volkov, in his science-fiction novel "Chuzhie" (The Strangers), describes how six inhabitants of a distant nebula landed on Earth. Their spacecraft met with an accident. To summon help they set up a radio transmitter on Earth. A huge wire cobweb acting as an antenna was spread out on thin poles. A short pivot on which a nebulous sphere revolved with a tremendous speed was set up vertically in a large crate. Above this station an air balloon shot up like a huge dense cloud. Below, in the wire net, blue, green and dark blue sparks flared up. The balloon reached the boundary of the atmosphere where it served as a wireless telegraph mast. An answer from their friends from outer space was soon received on the antenna.

4. RADIO TELESCOPES

Arel'skii's televiewer and telephonograph

An interesting description of two Martian communication devices is given by G. Arel'skii in his science-fiction story "Chelovek, pobyvavshii na Marse" (The Man Who Visited Mars). The hero is a Russian scientist, famous for inventing a rocket missile with an automatic cinecamera. Launched in America, the missile circled the Earth in 6 days and the camera filmed the entire globe from a tremendous altitude. The invention brought him a substantial sum of money and he was able to build a house in the suburbs, where he set up an observatory, the main instruments of which were a televiewer and a telephonograph.

The televiewer was an instrument similar to a reflector telescope. At its end was a large glass sphere near which electric cells were located (Figure 36). The telescope was called a "radio reflector" and the sphere a "light receiver." For radio and light transmission on Earth another such sphere was required, the so-called light-sender that was to reflect the transmitted image. In this case, however, to observe details on Mars, it was successfully replaced by a Martian satellite. This is how the author further describes the operation of the televiewer.

The inventor switched on the batteries and turned off the light. The bluish darkness of the sky filled the observatory, pouring in through the

(78)

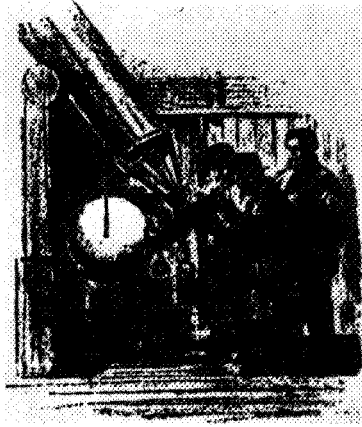

FIGURE 36. Arel'skii's televiewer

dome. The glass sphere began to spin rapidly and grew darker. Suddenly it presented a clear picture of a lake, surrounded by a solid mass of strange tall cylindrical buildings... (a description of Martian views follows)... Here is the place where six Martian canals intersect, forming a five-pointed star that was noticed by the astronomers Douglas and Pickering. Then an enchanting night landscape appeared, with this pentagram illuminated.

The telephonograph detected sound radio waves. The inventor placed near the reflector a small mahogany case with an induction coil and earphones. A thin metal needle abutting against a waxed ruled card-plate was soldered to the magnetic coil. Electric cells were connected with the case and the reflector.

Switching off the light, he started the sphere, in which a bright greenish star appeared. The arrow shook and began to draw a curve on the card. When the curve filled the entire plate, he stopped the instrument and, removing the record card, saw on it written the word "Murluu"... When his friend put the earphones to his ears and the plate was inserted in the instrument, he registered the following impressions: "The first instant I heard nothing but the metallic hum of the electric cells, but then it subsided and dead silence followed. Such silence I had never heard before on Earth. It seemed to fill my whole body with lightness, with absolute oblivion to the surroundings. This silence of the vacuum created in me a sensation of immersing into the quiet waters of an endless and bottomless lake illuminated by the greenish-blue light of the twinkling stars. I closed my eyes... And then I heard a quiet melody, so melancholy and delightful that my heart sank. Its rhythm reminded me of streaming light which changed colors and grew brighter. And when the melody finally reached its apogee, it suddenly stopped... And then I heard clearly resounding the mysterious word "Murluu." It sounded long and sad, reminding me of the striking of an ancient clock resounding over the whole hemisphere of the sleeping planet. And in its sorrow I found some deep hidden meaning, a revelation, an unsolved anguish of life... "

80 Semenov's graphobioscope

S. A. Semenov, in his science-fiction story "Taina iskopaemogo cherepa" (The Mystery of the Fossil Skull), describes a device called a "graphobioscope" which reproduces on a screen scenes seen by the man whose skull was found in geological deposits from the end of the first half of the Mesozoic Era of the Jurassic Period. According to the author, the scenes were impressed in the brain cells and were reproduced on a screen by means of the new device. The device utilized special rays discovered by a British physicist. A description of

our planet during the Jurassic is given: its vegetation, animals, and landscapes are projected on the screen. Then follows a description of the appearance of a spherical flying vehicle in which two people, perhaps inhabitants of another planet, arrived to visit the original owner of the skull. Still further follows a description of the interior arrangement of the sphere. Its main feature was a large revolving transparent blue sphere, set up on a high pedestal in the cabin. By means of this sphere, the mirror inside the cabin showed not only the landscapes over which the sphere was flying, but also Moon landscapes, magnified as if the mirror had telescopic properties. The motion of ships in canals, spherical flying vehicles, cities, palaces, and other views could be seen on the Moon. The story ends when the brain in the skull is destroyed and the skull is broken.

Motion picture transmission from Venus to Earth

Hans Dominik, in his novel "Das Erbe der Uraniden," describes how the inhabitants of a planet from another solar system, the Uranides, having landed on Venus, send special rays to Earth, which are recorded on motion-picture film and projected on a screen. The film showed the life of the Uranides on Venus.

Okunev's cinetelescope

Ya. Okunev, in his utopian novel "Gryadushchii mir" (World of the Future), provides an interesting description of a cinetelescope in the Universal City of the Future World.

The author describes the unexpected effect of this device when aimed at the Moon:

"Suddenly the Moon started falling to the Earth. Or the Earth to the Moon. Just a moment ago it was a silver lentil upon the blue sky and suddenly it began to grow. Within a quarter of an hour its diameter grew to a sagene. And the whole sky became clouded with a thick smoky haze obscuring the stars, and only the Moon showed through the haze, growing larger and larger. . .

Tens of observatories of the Universal City anxiously call to one another on the radio-ideograph:

- 81 — What is happening? What is happening? A universal catastrophe?
 — The law of gravity nullified! This is the end of the world!
 — Now terrible hurricanes are going to start!
 — Watch the magnetic needle! There will be a magnetic storm!

The world will perish from the explosion of the Earth's atmosphere before the Earth collides with the Moon.

All the inhabitants of the Eastern Hemisphere, where this phenomenon was taking place, crowded on the terraces of the Universal City and, horror-stricken, watched the sky. No stars, no blue sky. . . Only a brownish smoky haze stretching from horizon to horizon, with the huge face of the Moon showing on it. It covered already a quarter the sky. Here are its mountains and craters, deep-black on the dark side, blindingly white on the light side.

Somber, dead abysses... white sands... The observatories call to one another:

- No changes in the Earth's atmosphere!
- The magnet is still!
- No hurricanes!
- Science has gone bankrupt! We know nothing! — one astonished scientist repeats over the radio.
- No! No! Science does not lie! It is our eyes, our instruments that are telling lies! — say others.

The Moon covers half the sky. The fissures on the mountain slopes can be seen clearly, creases in the Moon's crust filled with something white... Snow? Another quarter of an hour passes. The entire sky, from end to end, is covered by the concave bowl of the Moon. Stones, rocks, sharp peaks knocked down into dead piles. On the light side, some subtle movement can be perceived. What is it? Life?...

And suddenly, it is as if some powerful hand has removed from the sky the huge disc of the Moon. Again the Moon is suspended like a small silver circle in the deep blue of the sky, again the fluffy stars are burning. And gold lettering across the sky clearly announces a light radiotelegram to the whole world: "I, the inventor Leslie, have just demonstrated my new invention, the cinetelescope. It consists of a telescope and cinecamera perfected by me. The telescope focuses the image on the cinecamera objective, magnifying it 20 million fold. A powerful reflector casts a shadow screen across the sky, and the cinecamera projects the picture on the screen. From now on, astronomical observations are possible not only in the observatories, but with the naked eye. Moreover, astronomic phenomena have become a sight for the masses."

5. TELEPHONE COMMUNICATION

Telephone communication between Moon and Venus according to Le Faure and Graffigny

Two French novelists, Le Faure and Graffigny, in their work "Aventures extraordinaires d'un savant russe" (1889), describe a method whereby the
82 Selenites, the inhabitants of the Moon, established communication with the inhabitants of Venus.

The Moon astronomers noticed shiny spots on the surface of Venus, which constantly changed their shape and arrangement. After many guesses they decided that these were signals which the Venusians exchanged with the inhabitants of other celestial bodies. Thus, when the meaning of the spots was understood, the Moon astronomers set up reply signals. On the surface of the Moon they found a metal (selenium) whose electroconductivity changes markedly depending on the incident light intensity. From this metal they constructed a huge reflector whose center was connected to an electric generator and with an apparatus for transmission of words. This apparatus transformed sound into light waves which traveled through space to Venus and were picked up by the Venusians by means of a

similar apparatus. Their apparatus transformed the light waves back into sound and, as a result, the Venusians could hear the Selenite voices as if they were not separated by a tremendous distance but were only a few paces away. The Selenites, in their turn, had the same option of listening to the Venusian voice.

Kryzhanovskaya's interplanetary telephone

V. I. Kryzhanovskaya, in her novel "Smert' planety" (The Death of a Planet), describes a device by means of which "the great initiates" communicated with the initiation sanctuaries of other planets in the solar system and talked with hierophants of distant worlds.

On a huge round gold table there was an apparatus resembling an enormous clockwork: small crystal or metallic discs and shiny wheels of various sizes spun rapidly, emitting colorful lights.

Long and thin hair-like needles moved swiftly over the discs, and from long tubes with wide ends phosphorescent strips came out, unrolling into spirals, rising and disappearing in the darkness above. All this puffed, panted, and shook, and tiny hammers beat time like bells. Along the edge of the table, enameled buttons of various colors were arranged, with shiny wires passing through the entire mechanism.

The apparatus worked on the same principle as a wireless telegraph; it was only necessary to control the vibrational waves and to aim in the desired direction.

This is how this mechanism was adjusted for communication of one of the planets with the Earth:

83 The instrument looked like a large telescope; at the end of its long tube there was a large movable disc covered on the inside with a gelatinous substance, speckled by thin phosphorescent lines.

An adherent pressed a spring with his finger and the disc spun with an amazing speed; at first, though, nothing could be made out but the fiery lines. After a while the rotation slowed down and it was as if a huge dark mass approached; then the outlines of a large continent appeared: objects showed clearer and clearer; mountains, plains, etc., could be made out in detail. It gave the impression of a spectator sitting by a window and watching inhabited places, cities, houses, and even faces pass before him.

Then the adherent took a plate covered with a layer of a gray gelatinous substance; a small hair-like spiral terminating with a tiny needle was fitted to its edge. The needle became white-hot when the adherent touched the lower part of the spiral.

He concentrated; a kind of a bright sphere formed on his forehead from which a ray of fire flashed and disappeared into space leaving behind it a phosphorescent trail. A second later another bright jet appeared and before it, like a shadow, the head of the Earth's adherent wavered. The strip of light touched the plate whose surface shook and shimmered and the needle traced phosphorescent letters...

People do not realize the tremendous power of the thought processes in the human brain, which may be regarded as one of the most powerful motors of the vibrational ether in the universe.

Voice transmission from Earth to Mars according to S. Lebedev

(84)

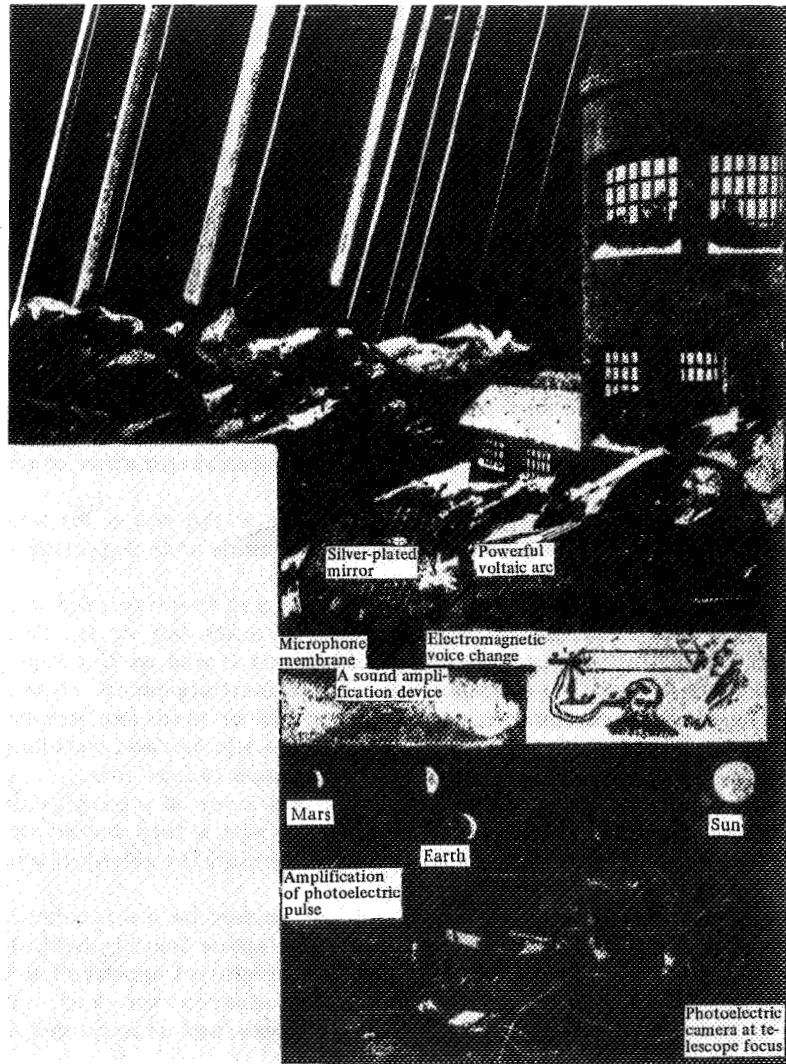

FIGURE 37. Sound communication between Earth and Mars according to Lebedev

Back in the 1870's, A. G. Bell, the inventor of the telephone, designed a photophone, i.e., a device transmitting articulate speech by means of light. Since the light ray has no weight and no inertia, long distances are of no importance when transmitting music and speech by the photophone.

It is assumed that a thousand arc lamps placed on high mountains will suffice to communicate with Mars (Figure 37). It has to be night on Earth, whereas on Mars it has to be at least one hour after sunset. The same figure shows the best position of the planets for communication between Earth and Mars.

If a Martian were to direct a giant telescope upon the illuminated side of the Earth, he would notice there a very weak light spot. If the observer is a good physicist, he can set up a photoelectric camera or some other photo-sensitive device in the focus of the telescope and, connecting it with a device transforming light into sound, he will reproduce music or voice sounds sent from the Earth.

85 Our telescopes, though, are still too weak to observe light spots on Mars, if the Martians try to communicate with us.

Figure 37 presents:

1) An observatory on a mountain on Earth and man speaking into the telephone.

His voice is amplified and transformed into electric rays transmitted from projectors to Mars.

2) The position of the Earth, the Sun, and Mars.

3) A Martian observing the Earth and listening to the sounds from Earth.

Communication in interplanetary space according to N. Mukhanov

N. Mukhanov, in his science-fiction novel "Flaming Abysses" (1924), describes methods of communication between the spacecraft of an interplanetary squadron from Earth. The orders of the squadron commander are broadcast via the luxograph in the zone illuminated by solar rays and via the chaosograph in the shadow cone of the planets. A special observatory was set up in the Himalayas to observe from the Earth what was happening on Mars. In the observatory dome there was tellurium – an exact replica of the part of the solar orbit between Earth and Jupiter. The celestial bodies moved along their orbits with mathematical precision in this model.

When an observer put a small refractor to his eyes and pressed one of the buttons, he saw, looking at the model of Mars, the smallest details of its surface, the Martian conference hall and, pressing another button, he could even hear the speeches.

Fonviel's Mars–Earth wireless telephone

The "Priroda i Lyudi" (Nature and People) magazine published an interesting picture of a device by means of which the Martians were supposed to be able to speak with Earth. Figure 38 shows this device, built according to W. de Fonvielle.



FIGURE 38. Fonvielle's Mars-Earth telephone

86 Magneto-electric communication with the Moon

Oskar Hoffmann, in his story "Mack Milfords Reisen im Universum," describes a magneto-electric apparatus for transmission of speech from the Earth to the Moon and back.

Okunev's ideograph

Ya. Okunev, in his novel "World of the Future," describes an "ideograph" for teletransmission of thoughts.

There is a meeting with about ten thousand people in the hall.

The bell strikes clearly. A rustling movement of ten thousand people is heard. They all apply to their temples two tiny cups adhering by suction to the skin. They plug the wires attached to the cups to the sockets fixed in the desks. Wires from the sockets stretch up, toward the dome, to a system of cylinders. This apparatus comprising the cups, the wires, and the cylinders, is the ideograph, transmitting thoughts, ideas, emotions. A perfectly sensitive plate in the ideograph cup detects the smallest vibration of the nerve substance in the brain and transmits these vibrations by pulses

to the listener, thus inducing the same ideas, thoughts and images in his brain. A speaker gets up. He mentally announces:

— Friends! I shall begin my speech.

The ideograph carries his thought into the consciousness of ten thousand listeners. Moreover, a cable is laid from the university dome to the city, along an underground pipe. In every home in the universal city there is an ideograph. Tens of thousands of people all over the world connect their ideographs to the cable and listen to the speaker.

INTERPLANETARY SIGNALS IN SCIENTIFIC PROJECTS

Existing and planned large telescopes

We have described various fictional telescopes for observations of planets and stars. Now we shall give, for comparison with reality, a table and a short description of existing and planned telescopes in different countries.

Telescopes

Year	Author	Type	Diameter in meters	Focal distance in meters	Location and remarks
1610	Galileo	Refractor	0.06		
XVII	Gottigniez . . .	"	0.15	40 - 70	Length 0.5 m Magnification 30 x
1812	Fraunhofer . . .	"	0.17		
1824	"	"	0.24		
1835	Mertz	"	0.35		
1862	Clark	"	0.47		
1872	"	"	0.66		Washington
1881	"	"	0.76		Pulkovo
1888	"	"	0.91		
1928	"	"	1.016		Chicago
1928	"	"	1.02		Lick (U.S.A.)
1929	Parsons	"	1.04		Pulkovo (ordered)
XVII	Gregory	Reflector	1.22		Yerkes, Chicago
1789	W.Herschel . . .	"	1.26	12	
1908	Ritchey	"	1.52		Melbourne
?	?	"	1.55		Perkins (U.S.A.)
?	?	"	1.83		Vancouver (Canada)
1908	Hooker	"	2.58	13	Mount Wilson (U.S.A.)
1929	?	"	5.08		U.S.A.
1929	?	"	5.60		Mont Blanc (projected)
1928	?	"	7.00	50	Solar Observatory (U.S.A.), projected
1928	?	"	7.62	61.9	Mount Wilson (U.S.A.) (projected)
1929	?	"	10.00		

88 Here are a few details about the projected telescopes.

1) The Pulkovo Astronomic Observatory ordered from Parsons (a well-known optics firm in England) the world's largest refractor.

The diameter of the refractor is 41 inches. The largest operational refractor (in Chicago) is 40 inches in diameter, and the main Pulkovo refractor is 30 inches.

The new lens together with the ocular will weigh about $\frac{1}{4}$ ton. The grinding will take 3–4 years. The astronomical telescope equipped with this glass will produce 2,000-fold magnification.

2) There is a project to build an observatory in the Alps, south of Mont Blanc, at an altitude of 1,350 meters. Its main instrument will have a mirror 560 cm in diameter. Two telescopes are to be built, with an aperture 80 cm in diameter, whose field of view will be much wider (the stronger the telescope, the smaller the section of sky that can be viewed at a time). The building of the observatory is planned to be finished in 1929–1930 and by 1932 the telescopes will also be completed. The new giant instrument and the observatory are sponsored by a private donation through the French government.

The 200-inch telescope

The largest existing 100-inch telescope (reflector) (weight of the mirror $4\frac{1}{2}$ tons, weight of entire installation 100 tons) in America in Mount Wilson Observatory no longer satisfies the astronomers. Recently a joint project of the Mount Wilson Observatory and the California Institute of Technology was conceived, to build a 200-inch reflector (5.08 m in diameter). It is proposed to cast the mirror disc from quartz, whose coefficient of expansion is negligible and thus eliminates the problem of protecting the mirror from temperature changes. To reduce the weight, the glass will be cast with trapped air bubbles and the top surface will be coated with a thin ground layer of bubble-free quartz. By means of this telescope, visual observations of stars up to the 21st magnitude will be conducted (Figure 39).



FIGURE 39. The quartz reflector

89 The 300-inch telescope

A project for a still more powerful reflector telescope with a mirror 300 inches in diameter (7.62 m) and focal distance of 2,400 inches (61.9 m) appeared in the USA in 1928.

Figure 40 shows a diagram of the proposed installations. The rays coming from a star fall on the mirror located at the lower end of the tube; they are reflected to the mirror at the top end and, after another reflection, are directed to the observer's eye in the spherical chamber under the lower mirror (Sci. Am., January, 1929, p. 21).

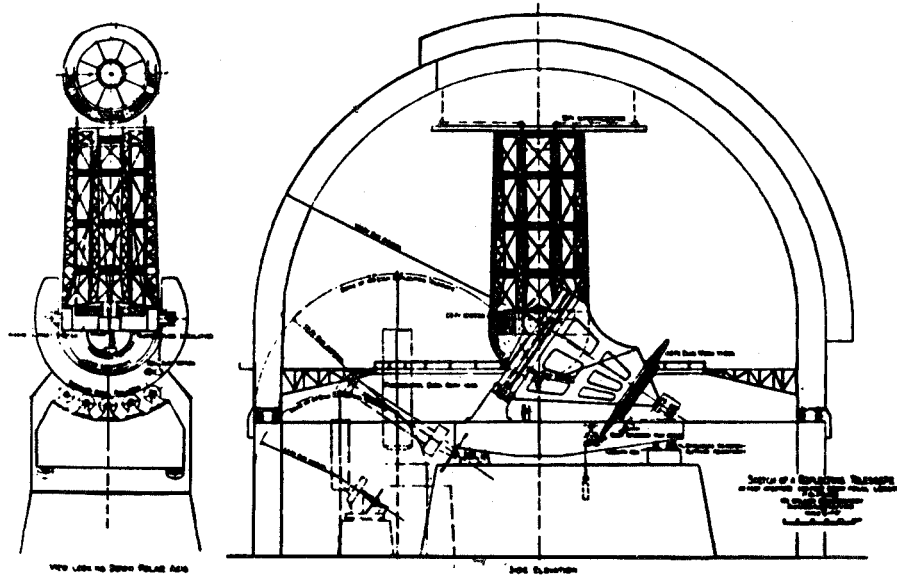

FIGURE 40. The 300-inch telescope (projected)

Wood's supertelescope

In 1908 the American physicist R. Wood at the John Hopkins University built a model of a reflector telescope (Figure 41) in which mercury served as the reflecting surface. The mercury was held in an open round vessel 50 cm in diameter spinning around the central axis. The stars reflected in the mercury surface were seen quite clearly. A thin layer of glycerin over mercury leveled out the small ripples.

Another American astronomer McAfee proposed to construct on the same principle a reflecting mercury surface 15 m in diameter at the bottom of a mine in Chanaral (Chile). This telescope would make it possible to observe only the stars in the zenith.

90 **Goddard's light method for determining the fall of a rocket on the Moon**

Determining the altitude of a rocket by means of a flash of some inflammable compound presents great problems, since at high altitudes the rocket is illuminated by the Sun and the flash is not visible against the solar rays. Goddard proposed to send a rocket to the dark side of the Moon during a new moon. When impacting on the Moon, the rocket should release a bright flash of gunpowder which would be seen through a powerful telescope.

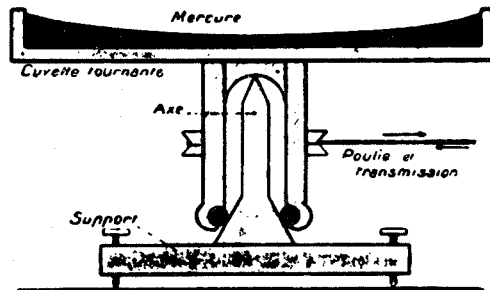

FIGURE 41. Wood's supertelescope

Goddard conducted experiments to establish the relation between the weight of the ignited powder (Vieter Flash Powder) and the visible range of the flash.

The experiments showed that when 0.0029 g of powder were used, the flash was noticeable from 2.24 miles (4 km), and when 0.015 g of powder were used, the flash was clearly visible from 2.24 miles (4 km) [sic in Russian original].

On the basis of these experiments, Goddard concludes that for the average distance between the Moon and the Earth of 220,000 miles (400,000 km) and with a telescope of 1 ft (0.305 m) aperture, 2.67 lb (1.2 kg) of powder will produce a barely visible flash, and 13.82 lb (5.8 kg) of powder will give a clearly visible flash.

Heaviside layer

Thanks to the tremendous improvement of the transmitting and receiving radio stations, it is now possible to establish communication between any two points in the world. The next step is to try to establish radio communication with Mars, which is never less than 55 million kilometers distant from the Earth.

Different factors, however, interfere with long-range radio transmission. Some depend on the very design of the transmitting station (wavelength and type of waves), others — on the properties of the medium in which the waves
91 propagate and on various meteorological conditions changing from day to day and from season to season.

Back in 1902, Marconi noticed that radio signals are transmitted better and more reliably at night than during the day. It was logical to assume that the changes hindering radio wave propagation were due mainly to the effect of the solar rays. Indeed, due to the high rarefaction of the upper layers, the gases may readily become ionized under the effect of the solar rays and the ultraviolet light (especially in the uppermost layers and in daytime). Ionized gases constitute a conductor of electricity.

Among the various attempts to elucidate the propagation of radio waves and deserving of particular attention is Heaviside's view advanced in 1900 and later developed theoretically by Eccles. According to the Heaviside-Eccles theory the curving of the radio waves (i.e., the propagation direction) is caused by reflection from a conducting layer (the so called "Heaviside layer") located in the upper ionized strata of the atmosphere.

From a number of experiments on the range of transmission on Earth, it follows that the "Heaviside layer" is located approximately at the altitude of 150–250 km, on the average about 200 km.

According to the theory of Lindeman, Dibson, Weygard and Størmer, a layer of crystalline nitrogen begins at the altitude of 120 km, i.e., near the belt to which the "Heaviside layer" is assigned; the Dutch engineer De Groot places a layer of rarefied hydrogen at this altitude. Therefore, it is quite natural to ascribe the existence of the reflecting layer to the presence of crystalline nitrogen, whose electric charge, according to Weygard, is responsible for the aurora borealis.

The radio waves reflected from this layer fall back on the Earth but do not penetrate deep into the ground. Thus, two screens block the way of the radio waves. These screens may roughly be compared to two mirrors: a convex one below and another concave mirror above, at the lower limit of the "Heaviside layer."

The properties of the troposphere, which extends to about 10–12 km above the ground, change little between day and night, whereas the stratosphere reaching up to the altitude of 100 km and consisting of highly rarefied gas changes its electric conductivity from day to night. Finally, the "Heaviside layer" has a continuous conductivity due to ionization. During the day, the stratosphere is highly ionized by the solar rays and therefore the radio reflecting surface is at its interface with the troposphere. At night, the waves penetrate all the way up to the Heaviside layer and only then are reflected (Figure 42).

The radio waves, or in other words, the electromagnetic rays approaching the "Heaviside layer" may, depending on the degree of conductivity 92 (ionization) of the atmospheric layers, be reflected and refracted in different ways, changing their direction.

Depending on the curvature of its path, a ray may meet, as is shown in Figure 43, with one of the following three possibilities: 1) if the curvature of the path is the same as the curvature of the Earth surface, ray I will circle the Earth unreflected and will reach the receiving station directly; 2) if the ray curvature is greater than the curvature of the Earth, ray II may, after being reflected from the upper layers, again hit the ground from which it will be reflected to the upper layers, i.e., the ray will pass from the upper to the lower layers and back. In this case the ray may miss the receiver altogether or reach it with very high intensity, or be completely attenuated on its way to the antenna; 3) if the ray curvature is smaller than

that of the Earth, ray III will either be reflected from the "Heaviside layer" (IIIa) toward the ground (it may also totally miss the receiver and follow the path of ray II), or it will escape altogether from the Earth's atmosphere (IIIb).

(92)

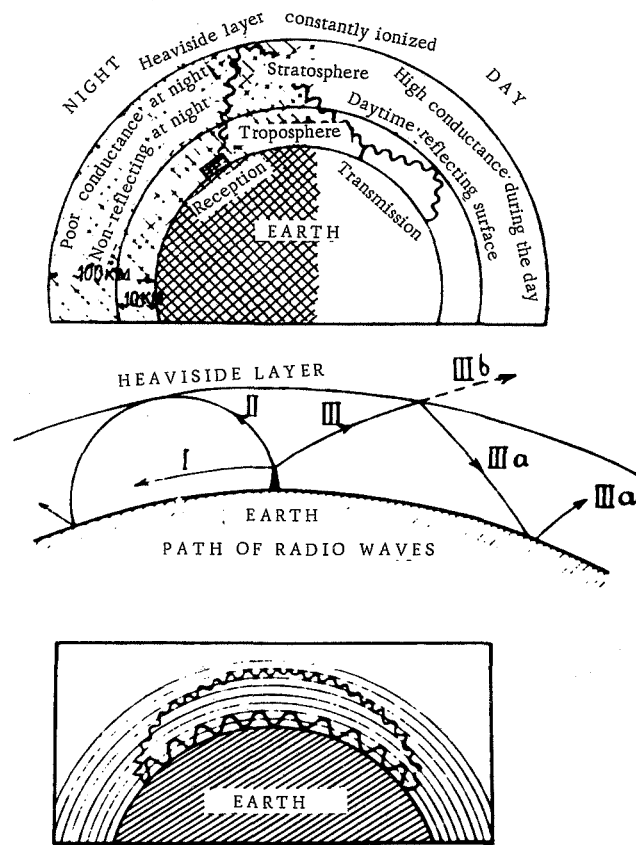

FIGURES 42-44. Radio waves and the Heaviside layer

What will be the further path of this ray?

We may only assume that its electromagnetic energy, encountering a conductive layer, will be partially reflected, partially absorbed changing into other kinds of energy, and partially scattered with decreasing amplitude of oscillations. Therefore, apparently, penetration of the radio waves beyond the "Heaviside layer" is hardly possible. Only in the zenith may these waves pass through the hydrogen layer, but for this a power of a few tens of million horsepower (15,000,000, according to Perel'man) will be required, which is not available at this stage for this purpose. Besides, if there is a similar "mirror" layer surrounding Mars, the radio communication with it will be still more difficult.

However, the "Heaviside layer" theory, assuming large wavelengths (500 m and longer), does not fit the actual propagation of the short waves (from 45 to 150 meters), and to explain the latter Meissner advanced a different theory. According to this theory the short waves travel around the globe partially reflecting from the variable density layers of the atmosphere (Figure 44). The shorter the waves, the more homogeneous a surface is required to reflect them and, while the long waves propagate through the dense atmospheric layer, the short waves penetrate it reaching a high surface homogeneous enough to reflect them. In the process they are partially refracted, i.e., their path is curved and the waves may return to Earth. Although the short waves may reach the "Heaviside layer," it is not certain and we cannot trace their path exactly.

In view of the fact that radio signals can be sent on short waves, there are many supporters of the opinion that the "Heaviside layer" may transmit radio waves. Here are Bering's thoughts on the matter. The work of many thousand shortwave radio amateurs proves that the "reflective layer" is a result of changes in the atmosphere under the effect of the solar rays. The higher the altitude and the more rarefied the air above the Earth surface, the more transparent it is to the short ultraviolet rays, which knock electrons out from the air molecules and transform them into electrically charged ions. The ionizing effect of the ultraviolet light is reinforced by a similar effect of the cosmic rays which also increases with altitude. As a result, the conductive or, to be more exact, semiconductive air at certain altitudes starts scattering the radio waves. Encountering this kind of a "Heaviside layer," the electromagnetic waves will not only be reflected but also refracted, i.e., some energy will pass through the ionized layer, tracing a curved path. For radio communication on Earth the reflected component of the radiation is important, for communication in the atmosphere the refracted component.

The ratio between the reflected and the refracted energy is determined for a particular wave by the angle at which the ray hits the "Heaviside layer." For each wavelength there is a "critical angle" above which the radiation will be totally reflected from the layer. But, as theory and experience teach us, the shorter the radio wave (below a certain limit), the more chances it has of being transmitted with maximum effect beyond the atmosphere, since its "critical angle" becomes smaller. Only a small sector of the wave propagating at a gentle slope to the Earth surface falls in these cases within the "critical angle."

The entire short wave may be transmitted beyond the atmosphere, by sending the radiation in one beam as close to the vertical as possible. The experiments with beamed transmission by means of "beamed antennas" concentrating the radio waves into one narrow beam, carried out in 1925 - 1927, showed convincingly that the shortwave radiation sent to the zenith did not return. This effect, as was to be expected, was strongest for the "ultra-short waves," 5 to 0.1 m long.

Mankind thus has at its disposal a method of radio communication with the Universe. From Russian radio-explorer V. V. Tatatinov came a daring suggestion: to begin the exploration of the lunar surface by sending a radio wave from the Earth to the Moon and analyzing the reflected wave upon its

return. Depending on the physicochemical structure of the Moon surface, the reflected wave will change its constitution and its intensity.

S. Zusmanovskii gives an estimate of the power of a radio installation sending messages to Mars. Supposing the distance between Earth and Mars is 100,000,000 km, and the required energy at the receiver is $1.5 \cdot 10$ joules per second per m^2 , the energy transmitted from the Earth into a hemisphere will be $1.5 \cdot 10^{-13} = \sim 10^{10}$ joules per second or 10,000,000 kilowatt. Assuming that half of this energy is absorbed by the atmosphere, the source power will be 20,000,000 kilowatt. Assuming 50 % efficiency, this is the equivalent of 600 Volkhov hydropower stations. At the rate 2 kopecks per kilowatt-hour, the station will run at a cost of about 800,000 roubles per hour.

If man masters the technique of the directional radio telegraph, then for a transmitter beam width of 5° , the power required will be only $\frac{1}{1000}$ of the above figure, which is still impressive: 20,000 kilowatt.

95 The radio stations for interplanetary communication must be of a special design. They will have to be covered with a solid metal layer or built underground, so that only the antennas emerge outside; otherwise the extremely powerful short waves penetrating inside will melt all the metallic parts of the station and cook the staff alive. The electric fields around such radio stations will be so strong that every exposed object will constantly draw lightning. Therefore there should be no buildings, living beings, etc., near the stations.

The radio echo and the electron eddies around the Earth

The experiments conducted in 1927 by a Norwegian engineer, Jorgen Hals, proved that when signals are sent from a shortwave radio station, the radio echo returns after 3 seconds. A Norwegian scientist, C. Størmer, detected a similar radio echo after $\frac{1}{7}$ second and another echo 3 seconds later; the second echo was weaker, about $\frac{1}{20}$ of the first signal.

96 In 1928 Størmer and Hals, repeating the experiment with a 30 m wave, obtained an echo after 3–15 seconds. Assuming that the radio wave traveling around the Earth in $\frac{1}{7}$ second could produce a repeating signal, it was necessary to explain the origin of the long intervals from 3 to 15 sec: if the same waves circled the Earth 200 times, its power would be much less than the actually observed power. If these rays were reflected by the Moon, the echo would be detected after 2.6 seconds.

A hypothesis was therefore advanced that radio waves are reflected by electron streams emitted by the Sun. These streams move to the Earth and, due to its geomagnetism, trace rings and eddies around it, especially near the poles (Figure 45) and the equator (Figure 46). Probably the same streams are the reason for the polar aurorae.

If radio waves are capable of penetrating the "Heaviside layer," they will also reach electron streams and be reflected by them. Taking into account the 15-second interval, the radius of the equatorial ring should be about 2 million kilometers. Since the duration of the echo is variable, the diameter of the ring of electron streams also changes.

(95).

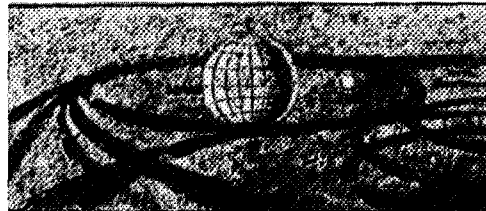
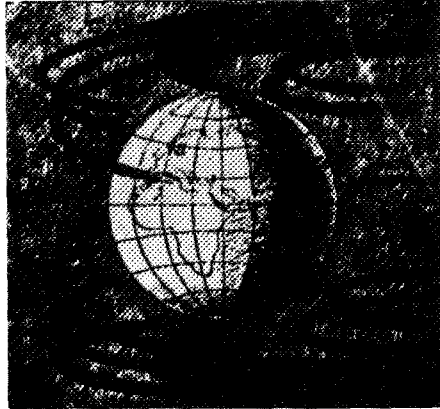

FIGURES 45-46. Electron rays from the Sun

Radio wave reflection from Mars

In 1928 Norwegian scientist Størmer discovered that a radio signal sent from Earth returns after 10-15 minutes, i.e., a radio echo effect is observed; this phenomenon was usually observed when in conjunction with the polar aurorae, which lower the density of the "Heaviside layer." In this case, it is easier for the radio waves to pass through the layer. Størmer suggested that the echo is a result of radio wave reflection from Mars. However, German radio specialists point out that the long round-trip time of the echo may be also explained by multiple reflections from the "Heaviside layer" and by the waves circling the Earth more than once before they reach the receiving station.

Radio viewers

The purpose of radio viewers or television is to make observable that which happens on Earth at any distance from the observer, regardless of the spherical shape of the Earth. For this purpose light waves are converted to radio waves and vice versa. The light rays reflected from some object

are transformed into radio waves which are transmitted to the observation point, to be reconstituted into light waves which either produce a real image on a screen or an imprint on a photographic plate. The French engineer Belain read a lecture at the French Astronomical Society on this topic and presented a calculation for the transmission of a small picture 18×24 mm. He assumed that this picture is fully characterized by 10,800 dots (five dots to a millimeter). Since the light ray acts on the eye retina 97 for $\frac{1}{10}$ second, the observer will see this image in another place if $10,800 \times 10 = 108,000$ signals are transmitted per second.

Mudlin's radio eye

The "Radio Amateur" magazine carried a notice about the project of American engineer Mudlin for sending "eyes" into interplanetary space which would enable the people remaining on Earth to see all the space views.

He designed a projectile to be launched from a gun and capable of interplanetary travel. Inside the projectile a radiotelescope (television) transmitter was set up.

The author suggests making use of Jenkins' radiotelescope (Figure 47) which should produce on the receiving screen a picture of moving objects located before the objective of the transmitter.



FIGURE 47. C.F. Jenkins



FIGURE 48. Mudlin's radio eye

The basic part of the Jenkins apparatus is a rotating prismatic lens projecting the transmitted image on a photocell coupled with the radio transmitter (Figure 48). The screen of the receiving station presents a moving picture of what takes place before the transmitter objective. The projectile moves by rocket propulsion: it is equipped with a cartridge belt and a mechanism feeding a cartridge into the muzzle; when the cartridge explodes, the projectile gains thrust.

The top drawing shows some details of the projectile; the center drawing shows the projectile with spread antennas in space transmitting radio waves to Earth; the bottom drawing presents a picture of the Earth as it is seen from the projectile, displayed on a screen in an auditorium on Earth.

- 98 A detail of the projectile is also shown in Figure 48. The different parts, starting with the head, are the following: reserve batteries, radio transmitter, photoelectric camera, Jenkins phototransmitter, rotating prisms, motor, thermal insulation, a photographic record of the Earth's path with the projectile moving away from it, a continuous moving film, a shutter operating by compressed air, special lenses, explosive tubes, antenna.*

Gramatskii's reflected electromagnetic waves

In 1926 Engineer Gramatskii suggested an original method of studying the lunar minerals by sending to the Moon powerful short electromagnetic waves by means of a projector. These waves, depending on the properties of the lunar surface, will be partially absorbed and partially reflected. The degree and character of reflection depend on the kind and the properties of the reflecting substances.

Observing the reflected rays on Earth, it would be possible to draw conclusions about the nature of the lunar minerals.

A radio eye on an airplane

An idea for using a radio eye on an airplane is shown in Figure 49. According to the inventor, special optical receivers — "eyes" — transmitting pictures of objects visible from the airplane to a radio receiver and then to a radio transmitter should be installed in different parts of the airplane fuselage. The radio transmitter antenna sends the pictures to a station on Earth, where the monitors (bottom) see everything that the "eyes" of the airplane catch from above.

Television in America

Television** enables us to see at a distance and to simultaneously hear (thanks to the "old" telephone) the person we see.

In April 1927 the director of the American Telephone and Telegraph Company in New York spoke with Secretary of Commerce Hoover in

* The American radio experts Docking and Rogers constructed for the same purpose an amplifier with 24-fold amplification. An American military radio expert John Sadler maintains that he regularly receives signals from Mars on a specially designed receiver.

** From Greek "tele" — far, and Latin "visum" — seen.

Washington. The distance between New York and Washington is about 200 miles. And nevertheless, the people in New York clearly saw Hoover, watched the movements of his face muscles, the turn of the head, smile, gesticulation, etc. The impression was just as if Hoover was right there, with them. The picture was exceptionally clear and the likeness complete. The importance of the new invention and the great future of the new instrument were discussed. The dream of scientists and science-fiction writers has thus come true: vision at a distance, which preoccupied them for several centuries, has become possible.

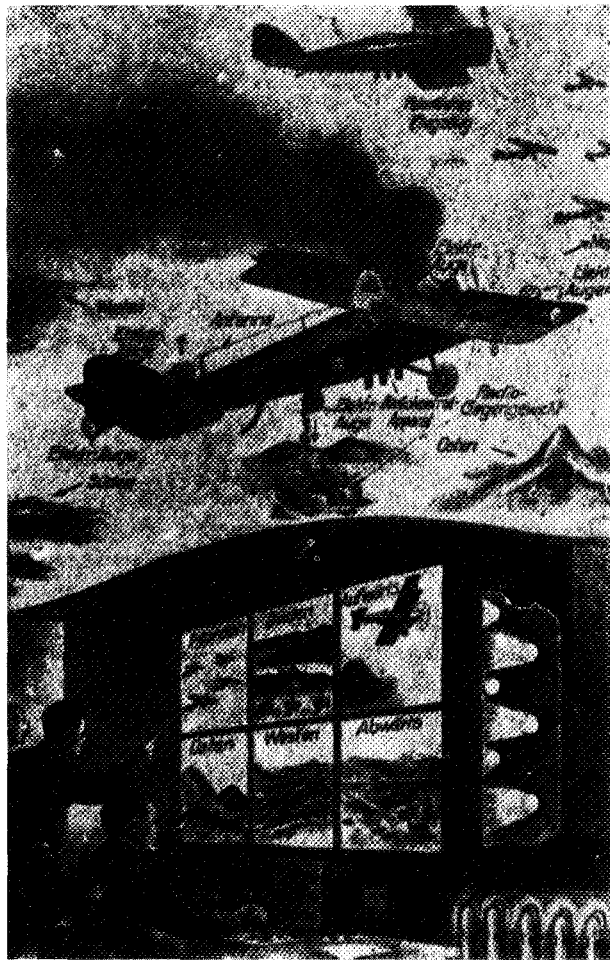

FIGURE 49. An airplane radio eye

This century-old dream was realized by Dr. Ivis and his assistants, the engineers of the Telephone Company. The inventor was not a novice in the field of inventions. He was a son of a famous scientist and inventor, Ivis

from Philadelphia. During the war Dr. Ivis himself supervised experiments on improvement of airborne photography; he also invented the "artificial eye," "day light" and other important and original inventions in the field of electricity and radio. Television, however, surpasses all his other inventions.

The essence of television is the following: consider a photograph as it is printed in a newspaper or on a page of a book. Take a magnifying glass and examine the picture carefully. It is easy to see that it consists of black dots, some larger and others smaller. In some places these dots are placed densely, in others they are widely spaced.

These changes in density, the position and the size of the dots are precisely what give the eye an impression of a picture: we see a face. The unaided eye, instead of the dots, sees contours whose shape corresponds to the features of a face; we then say that the picture is like the original.

If we had an instrument for transmitting these dot combinations to a distance and if this transmission could be intercepted by another device, the human eye (penetrating through the "dots") would perceive an image on its retina simultaneously as the ear hears the sound. In other words, we would be able to see and hear at a distance.

This is what has been achieved by television.

Let a person whose image is to be transmitted to another person, hundreds of kilometers away, be in a room in some city. The person to whom the image is transmitted is also in a room but in another city. The first room will be called the transmitting station and the second room the receiving station.

Consider what happens at the transmitting station. The person is sitting in a dark room, with light falling on his face. Opposite him there is a metal partition with a small aperture. The light rays reflected from his face enter the aperture and hit a special photoelectric camera which has a remarkable property: when the incident light intensity is strong, it conducts a strong electric current, when the light is weak the current is also weak.

From the transmitting station the camera current is directed by wires (or by radio) to the receiving station. The latter has a dark room with a screen in front of which sits an observer.

An electric lamp supplied by the current from the transmitting station is mounted against the screen. The lamp is screened by a metal partition with a small round aperture. Through the aperture a light beam falls on the screen. The current in the lamp is variable: it varies very rapidly and
101 the light spot on the screen changes its intensity correspondingly. Thus a complete analogy is attained with the newspaper reproduction of photographs, where the dots are spaced with varying density (darker and lighter areas).

Thus, the entire process consists of the following. Variable current from the transmitting station is passed to the receiving station, where the light it generates falls through the aperture in the metal partition forming a light spot. The partition with the small aperture is not stationary: it rotates so that the luminous spot changes its position on the screen. The photoelectric component of the transmitting station controls the luminous intensity of the electric lamp and thus the luminous spots appearing in different positions on the screen vary in brightness.

The photoelectric component also rotates. At one instant, it receives the light reflected from the man's forehead. The forehead is illuminated more brightly than the corners of the eyes; this bright light alters the obedient, "flexible" current and as a result the electric lamp at the receiving station

throws a brighter spot on the screen. If in the next instant a weaker beam enters the "camera," the bright spot on the receiving screen grows dimmer.

It should be noted that the apparatus contains as many as 16 apertures in the partitions in each of the stations. The partitions rotate very rapidly and therefore at any instant 16 luminous points of varying brightness appear on the receiving screen. This phenomenon repeats itself many times each second and as a result the imperfect human eye sees a replica of the face located hundreds of kilometers away.

A "televisor" built by the physicist L. S. Termen is known in the USSR.

Picture transmission over the radio is gradually becoming reality. The German Airlines (Lufthansa) conducted in 1929 a number of successful experiments of such transmission from the Earth to an airplane, transmitting to the pilot pictures of the meteorological map of the Berlin - Cologne route, a chart of the approaching storm, and a photograph of a partly flooded airfield.

Use of television in observation of Mars

Television can be used in the following way for more convenient observations of Mars.

On top of a high mountain, where the air is very clear, three telescopes are set up: one with a red light filter, the second with a yellow filter, and the third with a blue filter. The station transmits the three pictures to an auditorium in the city, where a projector with three similar light filters produces a single colored picture on a screen.

Luckiesh's supertelescope

M. Luckiesh, the director of the Light Research Laboratory in the United States, in his article in the "Scientific American" magazine (1926, p. 237) discusses a supertelescope which would allow people to see the Earth's past history as a continuous film. He suggests that one day an extremely powerful telescope will be invented using electricity for magnifying the images. He further considers some event which took place on Earth during a certain epoch at some location illuminated by the Sun. The light reflected from this area into space would reach after a certain time some celestial body, from which it would again be reflected, possibly in the direction of the Earth. Observing these rays through the supertelescope, one would see the event as it took place in the past. Choosing the North Star as such a "mirror," one would observe the events that took place on Earth 75 years ago. Choosing more distant stars, we could see the events which took place 150 years ago and earlier. For example, one could see Columbus approaching the shores of America (466 years ago, using the star Rigel as the mirror), but only in another 33 years. Choosing the Small Magellan Cloud as the mirror, the Stone Age on Earth could be observed. In other cases, the construction of the pyramids could be observed, etc.

Figure 50 shows the Earth's surface during different periods of its existence; it also shows the light reflected from the Earth towards various celestial mirrors and reflected back into the supertelescope through which the observer watches these events.



FIGURE 50. Luckiesh's supertelescope

Engineer A. Shorin, in his article "The Problem of Television" (Izvestiya TsIK, 29 May 1930), clearly characterizes the present state of the problem.

103 "The teletransmission of pictures has already advanced from the laboratory to practical exploitation. In Europe and here, in the USSR, photographs and manuscripts are transmitted with adequate results by wire as well as over the radio. The next step in this area of, so to speak, telegraphy using transmission of the entire picture, and not discrete symbols, is seeing at a distance.

Usually seeing at a distance is confused with transmission of pictures. There is, however, a distinct difference: the transmission of pictures involves transmission from paper to paper within some finite period, in practice from 8 m into $\frac{1}{2}$ min, of a drawing, a picture, or a newspaper cutting of 1-2 dcm². Seeing at a distance or television, on the other hand, involves transmission of a moving object onto a screen. In order to clearly see the moving object, it should be transmitted not less than 16 times each second. Thus, the difference lies in the rate or frequency of transmission. The difference in transmission rates for a static picture and television of comparable quality will be by a factor of 500, since a picture is transmitted in no less than 30 seconds, whereas for the purposes of television the same object has to be transmitted not less than 16 times each second.

From the technical side, all the problems of static picture transmission have been solved. The difficulty with television, on the other hand, lies in the fact that, as was shown earlier, the picture of the given object must be transmitted at a much faster rate than in static picture transmission. Moreover, the screen on which one sees the moving picture must be sufficiently illuminated; this is a very difficult problem.

The basic principles of television are the same as those of static picture transmission. The object to be "televised" is illuminated by as powerful a light beam as possible. An electric eye of sorts scans the entire object, tracing some complex or simple curve. Usually the picture is scanned in the same way as we scan a page of a book; beginning at the top, letter after letter along the first line, then along the second, etc. The size of the

electric eye is such that it simultaneously scans no more than 1--2 mm² of the object.

According to what part of the illuminated surface is scanned by the electric eye at any given moment -- a dark, a light or a half-dark element -- the eye transforms the light effect into a corresponding electric signal which is transmitted by wire or over the radio (in principle it makes absolutely no difference) to the receiving station. A suitable device at the receiving station illuminates on the screen that element of the transmitted picture
104 which is being scanned by the electric eye at that moment. Because of the changes in the current intensity, this receiving device produces a varying intensity on the same spot of the screen.

Of course, the component guiding the "eye" and the reproducing light spot should operate in perfect synchronism, i.e., if the "eye" is 2 mm from the edge of the transmitted picture, the reproducing light spot must be at the corresponding position on the receiving screen. This is achieved by fairly complex electromechanical instruments which ensure tremendous precision.

The electric eye and the reproducing light spot are extremely sensitive and complex components. Suppose a movie picture measuring 18 x 24 mm is to be transmitted. To scan the long dimension of the picture with a square "eye" $\frac{1}{4}$ mm on a side, the eye will have to "examine" separately $24 \times 4 = 96$ dots, and to scan the entire picture it will have to trace another $18 \times 4 = 72$ rows. The number of elements the "eye" will have to "examine" is thus $96 \times 72 = 6,912$. As was said earlier, to create the impression of continuity, at least 16 pictures per second must be transmitted, so that $6,912 \times 16 = 110,720$ electric pulses of varying current intensity must be transmitted each second. These pulses must be transmitted in perfect synchronism; moreover, their intensity depends on the available light intensity. With such a multiplicity of flashes and with such minute light dots, it is absolutely impossible to obtain large and bright pictures. The pictures obtained in practice always suffer from underillumination. Good transmission of pictures is impossible without a suitable light source capable of producing a sufficiently large number of flashes per second with light intensity strictly corresponding to all the changes in object illumination. Scientists all over the world are working on this question now. America took up the question before the others did and obtained fairly good results. Experiments with transmission of pictures over long distances -- up to a thousand kilometers and more -- were conducted.

This question is also being studied in England, but the British scientists work mainly on night vision, which is of considerable military significance. A face or an object is illuminated by infrared radiation, i.e., heat rays. The electric eye is sensitive to these rays and the object in the dark is seen with the receiving apparatus as clearly as if it were in a brightly illuminated room.

Besides night vision, work is also done on color vision. In principle it
105 creates no additional difficulties, but reception and transmission become even more complex since more components for the separation of colors are needed.

Work on transmission of moving pictures from broadcasting stations has now begun in America. So far the pictures are not clear but definitely moving.

In the USSR a number of laboratories worked on the problem of television. At the Electrotechnical Trust of Weak Current Plants (nowadays VEO-All-Union Electrical Engineering Committee) these problems are studied on a larger scale and the transmission of pictures (photographs, drawings) has reached the industrial stage: equipment is manufactured for practical use, etc. This year the emphasis will be placed on the transmission of sound films to a distance. Sound film transmission from one city to another will probably be realized: a film from Leningrad will be projected on screens in Moscow.

Note that at the present state of electrical and illumination engineering, television will not reach the perfection of the human eye or the cinema within the next few years. The relevant instruments and components are very large and need a whole room of an average size. It is therefore premature to think that any day now we shall have a small screen attached to every telephone on which a clear picture of the person with whom we are speaking and all the objects around him will be seen; many years will pass before this problem is finally solved.

Nevertheless, the ability to view at a distance the stark outlines of objects and pictures of moving objects without great detail may be of very considerable importance in practice.

The task facing us in the next few years is to simplify the instruments and make them more compact; it is also necessary to study all the physical processes involved, so that work with these instruments should become as simple as possible. They will eventually find an extensive use in daily life, although the results they produce are not perfect.

*CHANGING THE MOTION OF PLANETS BY ARTIFICIAL
MEANS IN SCIENCE FICTION*

"By an effort of my will I can deflect the Moon
from its orbit."

C.Flammarion, "In the Heavens."

Human fantasy knows no limits, and although interplanetary travel now seems only a fiction, the imagination of science fiction writers goes far beyond it. Some dream of turning the Earth's axis to change the climate, others change the Earth's orbit, still others change the motion of the Moon, Venus, Mars, the asteroids and other planets; finally, some even destroy planets or create interplanetary nebulae.

This chapter is devoted to the description of these fascinating fantasies.



FIGURE 51.

1. CHANGING THE MOTION OF THE EARTH

Turning of the Earth's axis according to Milton

According to Milton, the first change of the Earth axis orientation was accomplished by powerful angels by order of the Almighty. This is how it is told by Milton in the Tenth Book of his "Paradise Lost."

The Almighty

"... bid his Angels turn askance

The Poles of Earth twice ten degrees and more

From the Sun's Axle; they with labour push'd

Oblique the Centric Globe: Some say the Sun

Was bid turn Reins from th'Equinoctial Road
 Like distant breadth to Taurus with the Sev'n
 Atlantic Sisters, and the Spartan Twins
 Up to the Tropic Crab; thence down amain
 By Leo and the Virgin and the Scales,
 As deep as Capricorn, to bring in change
 Of Seasons to each Clime; else had the Spring
 Perpetual smil'd on Earth with vernant Flow'rs,
 Equal in Days and Nights, except to those
 Beyond the Polar Circles; to them Day
 Had unbenighted shone, while the low Sun
 To recompense his distance, in their sight
 Had rounded still th'Horizon, and not known
 Or East or West, which had forbid the Snow
 From cold Estotiland, and South as far
 Beneath Magellan."

Changing the inclination of the Earth's axis according to Jules Verne

The French novelist Jules Verne, in his novel "Sans dessus dessous," describes the project of the Baltimore Cannon Club to change the inclination of

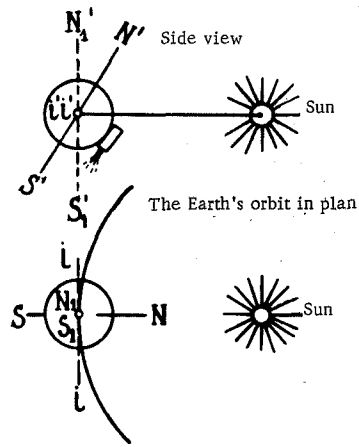

FIGURE 52. The deflection of the Earth's axis according to Jules Verne

the Earth's axis by means of a cannon shot. The recoil was to turn the axis $23^{\circ}28'$. Their intention was to exploit the coal-mines of the North Polar region when the ice melted under the effect of the Sun. The shot was to be fired to the north or to the south. When the shot is fired to the south (Figure 52) the Earth receives a jolt to the north and 1) shifts in the direction parallel to the shot, so that the plane of the orbit may shift but the shift would be very small, almost imperceptible and 2) at the same time the Earth would turn around the axis JJ in the equatorial plane. The deflection of the Earth's axis would be $23^{\circ}28'$, and the new axis N_1S_1 would be perpendicular to the plane of the orbit, as it is now for Jupiter. The caliber of the cannon was 1 million times that of a 27 caliber gun. The projectile weighed 180,000 tons. The muzzle velocity of the

projectile was 2,800 kilometers per second.

The shot was fired in Africa, south of Mount Kilimanjaro, in the country of the Masai Desert between Zanzibar and the lakes Victoria, Nyasa and Tanganyika. The muzzle was arranged in the form of a tunnel dug in Mount Kilimanjaro. Its diameter was 27 meters and it was 600 meters long. The inner surface of the rock was lined with carefully fitted cast material. The charge consisted of 2,000 tons of melomenonite

and the explosion chamber communicated with a container with mercury fulminate. The projectile was about 100 meters long (Figures 53-54).

However, as the result of error in calculations by one of the heroes, the shot did not produce the anticipated effect.

108



FIGURE 53. Jules Verne's cannon



FIGURE 54. The interior of Jules Verne's cannon

An error by a factor of 1,000 was made in a number which served as the basis of the calculations, i.e., the length of the equator was taken to be not 40,000 kilometers but 40,000 meters. Had this error not been made, 12 more zeroes would have been added to the solution and a much larger cannon would have been required to shift the pole by $23^{\circ} 28'$.

Astor's project to turn the Earth's axis

The English writer Astor, in his science-fiction novel "A Journey in Other Worlds," describes a method of straightening the Earth's axis in order to improve the climate of the Polar Region.

For this purpose, the weight of the pole receding from the Sun was increased, thus increasing the quantity of material absorbing the solar rays, whereas the pole approaching the Sun was lightened by transferring all the heavy substances to the opposite pole. Such shifting of the ballast is easy to accomplish by damming up and removing water from the Arctic Ocean in the summer, and increasing its average depth by 30.5 meters by means of dams in the winter. For this purpose 50 million square meters of turbines driven by windmills are required. Cables carrying electric power from Niagara

109 Falls join the cables of other machines driven by the tides in the Bay of Fundy. At a set moment, pumps begin to pump water; in some ponds water level may be raised by as much as 71 meters. The entire work has been estimated to take 10 years, beginning at the year 2,000.

Train and Wood's project to turn the Earth's axis

Wood and Train, two American writers, in their science-fiction novel "The Man who Rocked the Earth," hint at the possibility of altering the inclination of the Earth's axis by reaction of a powerful stream of special rays.

They do not describe the details of this method. The description of the rays follows on page 101.

Mukhanov's project to turn the Earth's axis

N. Mukhanov, in his science-fiction novel "Flaming Abysses" (1924), states that in the year 2400 the Earth's axis was straightened by means of the newly discovered element "nebulium" -- when its atoms disintegrate, a tremendous quantity of energy is released. When the axis was straightened the bodies of water on Earth changed their contours. A large part of the Arabian Desert was flooded, the Black and the Caspian Seas joined into one, etc.

Change of the Earth's speed of rotation according to Lasswitz

Kurd Lasswitz, in his novel "Auf zwei Planeten," describes a project suggested by one of the Martians during the Earth-Mars war to change the diurnal rotation of the Earth so that the time required to make one complete turn would be equal to the time in which the Earth makes one orbital revolution around the Sun. Then the attitude of the Earth relative to the Sun would be the same as the attitude of the Moon relative to the Earth, i.e., the Earth would always face the Sun with the same side, namely the Pacific Ocean. The Pacific would evaporate and the vapors passing into the dark side would condense into water, freeze, and precipitate as ice. The energy required to decelerate the diurnal rotation of the Earth was calculated. It was found to be equal to the energy of radiation reaching the Earth from the Sun in 600 years, if only the energy accessible to the people on the surface of the Earth is taken into account. However, the radiant energy will be much greater if all forms of radiation are taken into consideration. A special method, named "the Earth brake," was discovered, whereby the power of the Earth's rotation would be harnessed to do work, and thus the Earth will decelerate itself. Twenty years would be enough to achieve this goal.

This project, however, did not materialize, since the two planets signed a peace treaty.

110 Acceleration of the Earth's rotation according to Belyaev

A. Belyaev, in his science-fiction novel "Bor'ba v efire" (Struggle in the Ether) (1928), describes how a Russian scientist in the Crimea discovered a way to change gravity. He could decrease it at any point on Earth at the cost of increasing it at some other point. Any object entering the high-gravity zone falls and is crushed. Further, the scientist decided to decrease the gravity all over the world except at the poles and, as a result, the Earth began to rotate faster. The resulting centrifugal force drove the air, people, and material objects from the Earth into outer space.

... In the end it turned out that all this was only a dream.

Stopping the Earth's rotation according to Wells



FIGURE 55. When the Earth's rotation stopped

The English writer H. G. Wells, in one of his science-fiction stories, describes a method to arrest the rotation of the Earth. The hero of the story could work magic and on a certain occasion he expressed a wish to
111 stop the rotation of the Earth. It stopped immediately but all objects on the surface were displaced: water, air, buildings, animals, etc., and the hero himself rushed with a tremendous speed by inertia in the direction of the former rotation of the Earth (Figure 55). Experiencing the discomfort of his magic, the hero called off his wish, the Earth resumed its rotation, and everything became as before.

Correction of the Earth's orbit according to Astor

The English writer Astor, in his novel "A Journey in Other Worlds," hints at a method of correcting the Earth's orbit either incidentally, under the effect of attraction of some comet, or by means of a hypothetical substance "apergy" (about this see our publication "Spacecraft in Science Fiction," p.90) which is capable of intensifying or decreasing the attraction of other planets.

Changing the Earth's motion according to Service

Around 1928, G. P. Service, an American scientist, presented a fantastic view of changing the Earth's motion. If it were possible to neutralize the entire Earth, i.e., destroy gravity, the Earth could leave the solar system and join the system of some other star. If a comet threatened the Earth with destruction, it would be possible to neutralize this comet, deflecting it from its original path and thus saving the Earth.

Changing the contours of the continents according to Itin

Vivian Itin, in his stories "The High Path," describes a substance "ontëite" supposedly invented on Earth. With its help, the contours of the continents could be changed and mountains could be destroyed or shifted.

Destruction of the Earth by atomic energy according to Belyaev

A. Belyaev, in his science-fiction novel "Struggle in the Ether" (1928), describes how the last of the capitalists on Earth, persecuted by workers, want to escape on a jet-propelled vessel and destroy the Earth with atomic energy.

112 2. CHANGING THE MOTION OF OTHER PLANETS

Bringing the Moon closer to Earth according to Laury

French novelist André Laury, in his novel "Les Exiles de la Terre," describes a project for communication between the inhabitants of the Moon and the Earth by bringing the Moon closer to Earth by artificial means.

The operating principle. The author begins the discussion with reference to the Roman astronomer Secci, who said that between all the celestial worlds there is a mysterious bond — magnetism, whose influence no celestial body escapes. All bodies are subject to this magnetism and affect one another as huge powerful magnets.

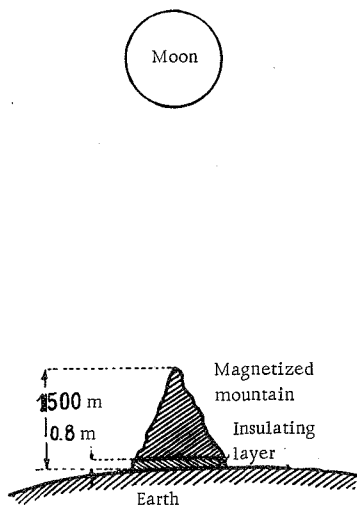

FIGURE 56. Attraction of the Moon according to Laury

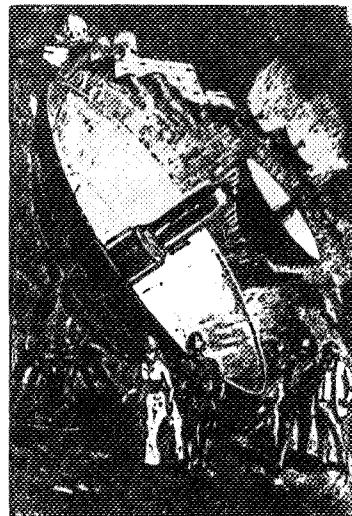

FIGURE 57. Laury's solar machines

The hero of the novel, Norbert Moni, continues by saying that the Earth is one of such magnets and has two poles, an equator, and magnetic parallels. There is no doubt that the Moon has similar magnetic properties. Gauss calculated that the strength of the Earth's magnetism is equivalent to the magnetic strength of $3,843 \cdot 10^{18}$ soft iron rods magnetized to saturation, each weighing 1 kg and occupying a total volume of 500 billion cubic meters.

The Moon in its motion around the Earth is influenced by the Earth's magnetic forces. Increasing the magnetic strength of the Earth, the Moon may be induced to change its trajectory and approach the Earth. For this it is enough to alter the magnetic force by one thousandth, which corresponds to creating an artificial magnet whose volume is 500,000 cubic meters, or a cube with a base of 50 hectares ($50 \times 10,000 \text{ meters}^2$) and a height of 1,000 m.

Instead of casting such an iron cube, natural iron deposits could be used, e.g., those in Tebel Peak in East Africa and in the Baiyuda Desert (east of Berbera and north of Khartoum).

Magnet design and operation. A special expedition was sent to the peak to transform it into an artificial magnet. The peak consisted of magnetic pyrite and was ideally suitable in terms of size, constitution, and geographic location. It was a cone 1,500 m high with basal area of 60 hectares.



FIGURE 58. The Moon approaches the Earth (Laury)

First the peak had to be isolated from the rest of the Earth. Since the peak had a sand foundation, an underlying layer of sand was to be converted into vitreous mass. The energy for sand fusion was generated by solar machines which stored the heat of the solar rays by concentrating them with reflectors on cylinders filled with water; the water was converted into steam and the steam energy was transformed into other kinds of power. Figure 56 presents a diagram showing the mountain with the insulating layer and the Moon.

Figure 57 shows a general view of the peak with a number of solar machines. The same machines generated electric current which was circulated around the mountain by wires, thus transforming it into a magnet of any desired strength;

special switches regulated the intensity in 360 successive gradations. The wire system control was located in the observatory on top of the mountain; the entire system could be turned on or off by two knife switches.

When the Moon was in perigee, i. e., closest to Earth, the current was turned on in the wires, the mountain was transformed into a magnet, and the Moon rapidly began to approach the Earth. Finally, its visible diameter filled an angle of view equal to $182^{\circ} 15' 22''$. Crowds of Arabs contemplated in terror the disc of the Moon (Figure 58).

114 At this moment, one of the members of the expedition, fearing a collision of the Moon with the Earth, disconnected the current. A terrible explosion occurred, the mountain demagnetized, the Moon receded, but because of local attraction the Earth's interior gases erupted and transported Peak Tebel to the Moon, together with the observatory and its staff.

A description of their life on the Moon follows.

Return. Since all the solar machines remained intact, it was decided to use them to magnetize the mountain, as previously, and to make the Moon again approach the Earth. A huge silk parachute with a gondola large enough to accommodate the entire staff was designed and built for crossing to the Earth. The parachute was suspended on a long metal shaft supported by pillars (Figure 59). The shaft was turnable to facilitate proper orientation of the parachute suspended in the middle.

When the Moon, under the action of the magnetized mountain, approached the Earth, the travelers entered the gondola and as the parachute gradually deviated from the plane of the scaffolding under the effect of the Earth's

attraction, the gondola turned to face the Earth. When the Moon entered the Earth's atmosphere, the commander of the parachute turned off the current, the mountain demagnetized, the parachute detached and began descending to the Earth, while the Moon receded (Figure 60). The descent was satisfactory and the travelers found themselves on the banks of the Nile.

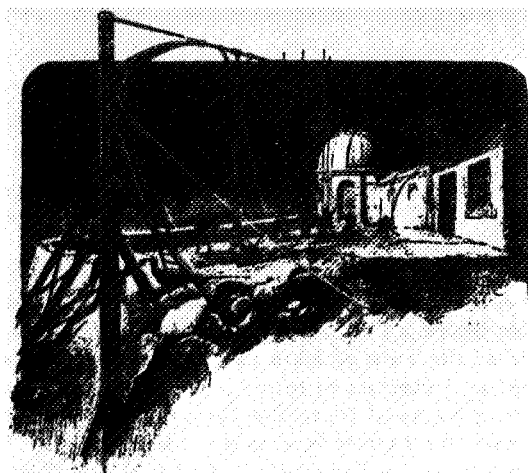

FIGURE 59. Construction of the parachute on the Moon



FIGURE 60. Descent from the Moon by parachute

115 Changing the motion of the Moon, Venus, and Earth according to Goncharov

V. Goncharov, in his science-fiction novel "Mezhplanetnyi puteshestvennik" (Interplanetary Traveler) (1924), describes the following method by which the motion of the Moon, Venus, and Earth was altered with the purpose of: 1) preventing the Moon from approaching the Earth, as a result of the increase of the Earth mass from falling meteorites; 2) providing the Earth with an atmosphere of normal composition, since the burning of the falling meteors caused a deficiency of oxygen in the air; to this end, it was decided to pump air from Venus; 3) preserving the usual length of day: the Earth, having gained in mass, spun more slowly and its days became longer.

A mechanical axle was inserted from pole to pole inside Earth and Venus. The ends of the axles of both planets were joined by mechanical clamps accommodating pipes through which air was pumped from Venus to Earth.

The clamps linked the two planets into one whole. Giant clockworks were set up on the axles. They rotated both planets with mechanical precision so that a day on each planet was 24 hours long. As far as the Moon was concerned, at first it was joined with Venus in the above described manner, and then its entire mass was transferred part by part to Venus.

Note. The idea of connecting two planets by means of a mechanical bond (a pipe) was expressed earlier by A. Laury, who proposed to join in this way the Earth with the Moon (see "Dreams, Legends and Early Fantasies" ("Mechty, legendy i pervye fantazii"), Issue No. 1, p. 104.)

Altering the Earth's gravity and altering the motion of the Moon and the Earth according to Mure

N. Moore, in his science-fiction story "Six Months," describes a number of phenomena which could take place if the Earth's gravity was altered, first decreasing and then recovering to its normal value.

F. Smith, an Australian, discovered a way to eliminate the Earth's gravity. When he gradually began to apply his method, the gravity decreased almost to a half. This change did not take place all at once, and it began to spread from the Earth's interior upwards at the rate of 1 km per hour. After a few years, the Moon lost half its weight and started to move away from the Earth along a spiral trajectory. Finally, it escaped from the Earth altogether and receded into unknown space, attracted by Jupiter's gravity. Later, for the same reason, the Earth started to recede from the Sun and life on Earth was threatened with extinction from cold. . . However, quite unexpectedly, a reverse change took place. The Earth's gravity increased and at first even became greater than normal. Eventually it returned to normal.

116 Altering the motion of the asteroids according to Tsiolkovskii

K. Tsiolkovskii, in his book "Grezy o zemle i nebe" (Dreams of Earth and Heaven), expresses the thought that, if people manage to move to the small asteroids and inhabit them, they will also learn to control their motion, decrease or increase their axial rotation speed, approach or recede from the Sun, break the asteroid into a number of small fragments, etc.

Altering the orbit of the asteroid "Medusa" according to Train and Wood

In the year 1917 two American authors, Professor R. Wood and novelist A. Train, in their novel "The Second Moon," describes the struggle of people with the asteroid "Medusa" whose orbit was altered by a passing comet. The asteroid threatened to fall on Earth on 22 April in America, near Mexico. The distance of this asteroid from the Sun was only 2.13 times the distance of the Earth from the Sun. Its diameter was about 240 km.

It was decided to send a rocket-propelled spacecraft, "The Flying Ring," into interplanetary space with a crew of four (see "Spacecraft in Science Fiction," p.141). The spacecraft was to attack the asteroid with a destructive ray and deflect it from its path.

After a few adventures on the way out, "The Flying Ring" approached the asteroid to a distance of about 800 km and settled in a parallel orbit. Both moved toward the Earth.

Ahead, through the spacecraft window, the muzzle of a powerful attack weapon was visible, the source of the disintegrating rays, a new form of radiant energy. In a few minutes the mysterious ray would be projected through space. The noise of the machines leading the electric current into the inductor winding was clearly audible in the cabin. Both dynamos worked at full speed and the whining of the radio turbines filled the air. A huge cylinder, like a siege-mortar, slowly turned on its pivots. It now remained to direct the full current into the winding through a copper switch on the control board and to send the ray. Finally, the switch was turned. A drone of the alternating current in the inductor winding could be heard.

One minute... Two... Apparently, there was no result. The outer side of the inductor turned dark-red, then white-hot. No ray was visible, but it had already been projected and had cut through space (Figure 61). A sudden flash of light flared up on one side of the asteroid. "Low... Too low!" the pilot said, but the asteroid had to be stopped and he gave the order to commence the destruction.

He pressed a button. The cylinder outside the ring slowly swung on its axle. Almost immediately a dull spray of yellow fire appeared on the dark surface of the asteroid and burst into space.

117

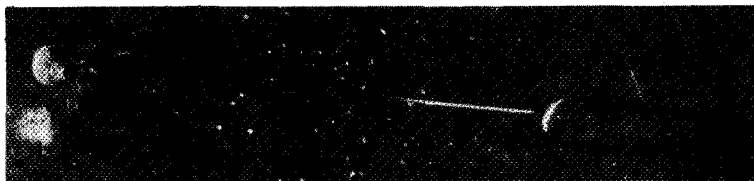

FIGURE 61. Destruction of the asteroid according to Train and Wood

Little by little, the luminous eruption on Medusa intensified until the planetoid transformed into a ball of fire. Giant streaks of yellow light, like the auroral rays, extended from the surface of the asteroid. The deadly ray bored again, and soon the whole asteroid erupted like a volcano. The surface of the asteroid began to break under the relentless pressure of the ray, and flashing masses of incandescent gas were ejected into space. The whole spectacle was like gunpowder stores set ablaze, viewed from a safe distance.

The Medusa retreated; its disc was clearly diminishing. There was no need to press on with the attack. The current was cut off. The asteroid's orbit was altered and it became a harmless satellite of the Earth.

Controlling the motion of Mars according to Arel'skii

G. Arel'skii, in his work "Stories about Mars," writes that Martians invented a method of controlling the motion of their planet and of its satellite Damos by means of a new gas "yutli" which would explode in case of necessity. The gas could overcome the force of gravity and impart to Mars motion independent of the Sun.

The Martians had to apply this method when the solar energy had run so low that permanent cold prevailed on their planet and it was covered with a layer of ice. In order to change the living conditions, the Martians decided to leave the solar system and move, together with their planet, to another hotter sun.

To accomplish this aim, huge structures 15 kilometers across were erected on Mars' pole. The gas was exploded in these structures. The explosions enabled the planet to break away from the Sun and to move through space to a new sun. Outer space is interspersed with dark gaseous nebulae and with cosmic dust clouds. At that time Mars was in an encounter with such a cloud. This lucky chance enabled the Martians to
118 overcome the attraction of the Sun and escape into outer space by means of an explosion directed to the densest part of the cosmic cloud.

When the signal was given, the explosion was triggered on the pole and the planet accelerated into space, receding from the Sun. The gas "utli" was manufactured by special plants on the pole from an ore extracted from the bowels of the planet. It was pumped through pipes from the plants to the motors and propelled the planet.

Changing the motion of planets by artificial means according to Mukhanov

N. Mukhanov, in his science-fiction novel "Flaming Abysses" (1924), describes how the people of Earth and Mars discovered ways to alter the motion of planets and comets.

These problems arose because of the Earth-Mars war. The Martians worked out a plan to steal the Earth's Moon and drive it into outer space. To counteract this plot, one of the great Earth scientists found a powerful method to control the motion of planets.

This is how this method is described by Mukhanov:

"The discovery of a new kind of energy, called the "energy of arbitrary motion," enables us regardless of the distance to accelerate, decelerate, and arrest the motion of stars at will, to attract new worlds into the sphere of gravitational pull of a planet and to expel into outer space those members of the system which for some reason have become either dangerous or undesirable.

A scientist by the name of Ken first experimented with controlling the motion of planets on the tellurium model and then with the real planets in nature.

The model experiment consisted of the following:

Spherical objects of various sizes floated with different speed and along every possible ecliptic in a huge transparent sphere of metallized crystal, containing not a single air atom.

A small sphere, containing an inexhaustible source of energy of the newly discovered element "nebulium," was located at the center of this transparent system.

The objects floating inside the sphere found their paths on their own and moved about a common center tracing various closed curves.

Ken stood facing a number of small instruments and controlled them by means of button reservoirs. "These rays are invisible," explained Ken.

"Strictly speaking, they are not even rays, this is something capable of utilizing the energy of the arbitrary motion of bodies in space, which is otherwise pointlessly wasted in vacuum. Quite by chance it occurred to me that since inertia exists, there should also exist the energy of inertia.

119 If my basic idea is correct, the rest will come by itself. It was not hard to collect this energy; first I built a number of instruments of modest size for this purpose, and later advanced to a large, cosmic scale.

In this model, the celestial objects may be driven by an invisible and even intangible force (intangible at least to our crude perceptive centers)."

Ken pressed a lever.

The steady motion of the objects in the crystal sphere instantaneously lost its regularity. The little planets began to jump in different directions, outdistancing one another and colliding with each other. "This, so to speak, is mass panic," said Ken, "but selective effects are also possible. Let us take this distant giant, Vulcan. Now it moves with a barely perceptible speed. Now it slows down. Now it has stopped altogether. . . . And here is Mars, a miniature replica of our foe. It moves with the relative velocity of the original and in the same ecliptic plane. Let us first alter its ecliptic.

Do not forget that the "planets" are under the influence of the energy of their own motion, whereas my apparatus contains only the utilizing will. Now let us slow down the motion of Mars in its orbit. And now — accelerate it; change the inclination of the axis; stop its rotational motion; turn it in the opposite direction; nail the planet to the "firmament." If we leave this replica of Mars in a stationary position, the radiant energy of the center, as we know, will lead to disintegration of matter, and after a while the sphere will exist no more.

All that I have just demonstrated in this toy universe can be done on a large scale as well, with the real planets. Any of these actions — acceleration, deceleration, and especially stopping the planet — threaten everything on it with death. Not that I intend to use my discovery for such unseemly purpose. I would only like to frighten the restless Martians somewhat, quite harmlessly," Ken concluded gaily.

"Let us now pass to the real "tellurium," and not this toy, and think together whether it is possible to send the Martians some harmless but significant warning to make them drop their belligerent plans."

Ken and his companions moved into the adjacent room and stopped in front of a huge refractor, the end of which was lost in the darkness above.

"What are we going to do to advance our pacifist aim? Shall we accelerate or decelerate the enemy's planet, alter its orbit, or make the planet spin like a top? . . . We shall try to take into consideration the possibility of fatal consequences of our experiment, but we have to show the enemy his dependence on us. This is what we shall do. . . ."

Ken placed his hand on the lever (Figure 62).

120 What was happening on Mars?

The morning came somewhat "reluctantly" for the Martians in the northern hemisphere, where the cultural life of the planet was concentrated.

It was unbearably hot and stuffy. The Sun was in no hurry in its daily movement across the sky. Having barely risen above the horizon, the dull golden Sun seemed to have stopped.

The astronomers, of course, were the first to notice incomprehensible changes in the planet's rotation about its axis. The rotation rapidly and steadily decelerated, threatening to stop altogether.



FIGURE 62. Altering the motion of Mars according to Mukhanov

The Sun, having completed only a quarter of its round, hung motionless in the golden sky. Unbearable heat irrepressibly spread over the face of the planet... Mars was perishing... and only after surrendering to Earth... the Sun slowly crawled upwards, resuming its usual round across the Martian sky. The unbearable heat rapidly abated...

Ken's brilliant discovery disturbed the measured motion of the planets and made them toys in the hands of man, pawns in a chess game of the worlds, which the human genius could move at will.

As could be suspected, no fixed harmony had ever existed in the interrelations of the celestial bodies; there was only a forced coexistence of
121 neighbors, chasing each other, incessantly striving, by the law of compact masses, to become compacted, to blend together, to swallow each other, to justify the primary supreme law of chaos according to which any accidentally established regularity is a violation of the basic law of cosmic motion, i.e., to be in a permanent state of regrouping, turbulence, and bubbling of matter.

Ken only discovered a method to alter, to accelerate and decelerate the motion of planets, utilizing the force of their own inertia. Consequently, he discovered a possibility to prolong the brief instants of harmony established by chance, to foresee and prevent the inevitable catastrophe, or alternatively to precipitate the catastrophe if so desired.

The next opportunity for using Ken's discovery presented itself when Mars was threatened by a collision with a comet moving from the constellation of Canis major. The comet rushed towards the Mars orbit with a tremendous speed and was about to intercept it at a point where Mars would be passing at that particular moment.

Only 48 hours remained before the collision. Panic drove the Martians insane...

And then the nightmare passed. The few astronomers who survived the panic reviewed their calculations and noted with joy that the path of the comet had been deflected.

At that time Ken was in his Himalayan observatory and did not leave his powerful machine utilizing the inertia of the celestial bodies. The man in whose hands lay the fate of Mars was silently concentrated and slightly worried about the outcome of his superhuman endeavor. The heart of the matter was that the specific gravity of the huge comet could not be calculated exactly. The "inertia machine" operating at full speed indicated that the comet deviated from its path by only 200 kilometers during the first hour. During the next hour the deviation increased to 140,000 km. Finally, the orbit of the comet was altered so much that it passed 500,000 km away from Mars, not harming it in any way.

Disintegration of planets according to Tsiolkovskii

Asteroids and planets can be gradually disintegrated by utilizing the solar energy and transforming it into mechanical energy. This idea is expressed by K. Tsiolkovskii in his book "Dreams of Earth and Heaven," where he writes: "I do not touch upon methods of breaking up a planet into fragments nor of changing its shape. I just assume that these methods exist and that they are so efficient that the work of the solar rays is completely utilized in this process." Under such conditions, Jupiter may be disintegrated into a nebula within 115 years, Earth within 4 days, the Moon within 3 minutes, etc. In practice, however, planets do not receive the entire solar energy, but only a part thereof, that which falls on their surface. Therefore, these rays, producing a mechanical effect on the planets, will take much longer to cause disintegration; for example, the Earth will be disintegrated in 26 million years, the Moon in 170 thousand years, etc.

Interplanetary war

In 1924, N. I. Mukhanov, in his novel "Flaming Abysses," gives a description of the methods used in the Earth-Mars war in the year 2400. The cause of the war was the fight for the deposits of a valuable element "nebulium" found on the planetoids. At the time of the war, the Moon

belonged to the people of the Earth. To defend the Moon and the Earth from an attack by the Martians, an extremely powerful defense line was set up 500,000 kilometers from the center of the system. Battleships, in an unbroken chain at equal distances from one another, moved in the direction of the Earth's diurnal rotation with the speed equal to the axial speed of the Earth itself. This made it possible for the spacecraft to remain stationary relative to the point of the planet which they were supposed to defend. The defense line thus formed one whole with the Moon—Earth system, and the Earth satellite distant 300,000 kilometers was thus inside the defense perimeter.

Several powerful space-destroyer squadrons were ordered to attack the Mars satellites — Deimos and Phobos. Other spacecraft, cutting through the Mars orbit, were to advance toward the planetoids, partially to defend and guard their 150 colonies, but mainly to destroy the principal enemy bases.

The position of Mars in space was almost on the straight line Earth—Moon—Mars, and the enemy center was at its nearest to the Earth during the war. The strategic position of Mars was favorable to the highest degree.

On the whole, the military objective called for the destruction of the enemy offensive potential and defensive forces in a minimum of time and the destruction of the two terrible Martian bases storing tremendous supplies of energy — the Mars satellites. The latter seemed quite feasible in view of the small size of the satellites.

The attack on Phobos took place in the following way: heat rays and then especially powerful "nebulium omega rays" were directed at Phobos for a quarter of an hour. This maneuver produced excellent results. In a few minutes Phobos started giving off a pink vapor and a few minutes later it flared in a point of fire. In retaliation, the Martians directed heat rays of unusual power at the Moon, heating its surface; an atmosphere was generated as a result.

For a few hours the Moon had to endure the streams of fiery rays of unparalleled force. The rays melted the ice cover on the Moon and covered the satellite with a thick atmosphere, in which terrible electric storms raged.

123 At the same time the Earth squadrons penetrating beyond the Mars orbit attacked its other satellite, Deimos. Troops were also directed to the most important strategic points of the Martians, the planetoids.

Finally, all the fresh reserve troops were ordered to attack Mars.

The defense line around the Earth, strongly depleted, had to show maximum activity, protecting the home planet and deflecting by counteracting means the fatal streams of the Martian death rays.

The war of the worlds reached the apogee of bitterness in a short time. Phobos was burning, transforming into primeval chaos.

Deimos was ablaze, set on fire from the other side (at that time it was hidden behind Mars).

Asteroid colonies of both sides perished in dozens from the deadly fire and from collisions with one another.

Hell broke loose at many points on Earth and on Mars... The atmosphere of both planets was heated to the utmost. Titanic constructions lay in ruins. Living beings were hiding deep in stone shelters.

The Martian capital ceased to exist. Some 40 to 50 planetoids were also destroyed.

Artificial interplanetary fog according to Mukhanov

N. Mukhanov, in his science-fiction novel "Flaming Abysses" (1924), describes the Earth-Mars war in 2400 and reports that the Martians tried to hide their planet from the interplanetary battleships of the Earth behind a cloud of grayish fog.

Altering the path of the Sun according to Milton

John Milton, in his "Paradise Lost" (Book X), writes that as a punishment for the Fall, the Almighty

"... bid his Angels turn askance
the Poles of Earth twice ten degrees and more
From the Sun's Axle; they with labour push'd
Oblique the Centric Globe: Some say the Sun
Was bid turn Reins from th' Equinoctial Road
Like distant breadth to Taurus with the Sev'n
Atlantic Sisters, and the Spartan Twins
Up to the Tropic Crab; thence down amain
By Leo and the Virgin and the Scales,
As deep as Capricorn, to bring in change
Of Seasons to each Clime;"

Stopping the Sun and the Moon in the Bible

In the Bible there are indications that Joshua stopped the rotation of the Earth so that darkness would not interfere with his fighting with the enemy.
124 In the book of Joshua, Chapter X (verses 9, 12-14) we read:

"Joshua therefore came unto them suddenly, and went up from Gilgal all night.

Then spake Joshua to the Lord in the day when the Lord delivered up the Amorites before the children of Israel, and he said in the sight of Israel, Sun, stand though still upon Gibeon; and thou, Moon, in the valley of Ajalon.

And the sun stood still, and the moon stayed, until the people had avenged themselves upon their enemies. Is this not written in the Book of Jasher? So the sun stood still in the midst of heaven, and hasted not to go down about a whole day.

And there was no day like that before it and after it, that the Lord hearkened unto the voice of a man: for the Lord fought for Israel."

Concluding this chapter, I would like to note that passengers of the interplanetary vessels of the future will be able to witness apparent changes in the motion of the Moon, the Sun, other planets, and even stars. As the spacecraft moves around the Earth with velocities greatly differing from the linear rotation velocity of the Earth, the passengers will observe the Sun or the Moon rise faster, or move back across the sky, or stand still, depending on the direction and the magnitude of the spacecraft velocity.

Changing the path of Swanley's comet according to K rouan

The French novelist Jean K rouan, in his novel "The Comet-Hunters," develops an interesting idea for changing the path of Swanley's comet.

A French professor Granger discovered a method of affecting the orbits of comets. In particular, he proposed to seize an opportunity when a comet approached the Earth to convert it into a satellite. This would improve the climate, raise the productivity of the soil, and a Golden Age would once more come to Earth. . .

However, Granger's assistant, the Asian, Sven Tzyuren, puts the professor into a deep lethargic sleep from which nobody can wake him and, having stolen his secret, departs for Mongolia, to the Tibetan border. There he founds a fortress and a palace in the city of Karakorum, in the desert, with the money he treacherously stole from an American billionaire. In the Karasu Mountains he builds a machine whereby he can direct Swanley's comet. toward the Earth.

By radio he demands ransom and obedience from all the peoples of the world and names himself Khan Zagan. He also demands Professor Granger's body.

125 A group of Frenchmen decide to free the world from the Khan's tyranny and go to Mongolia. A Tibetan lama, Wang Tsao, helps the Frenchmen in their endeavor. Khan Zagan, bringing the comet close to Earth and threatening to precipitate a collision, converts it into a satellite upon receiving ransom. However, having incompletely mastered Granger's secret, he wakes him up in his palace upon receiving the body. But as it turns out, the lama Wang Tsao has transferred the professor's soul into his own body, and his own into the professor's body, and refuses to disclose the secret. Zagan, before waking the professor, wants to take revenge on a beautiful Mongolian girl who has turned down his love and again directs the comet toward the Earth. To prevent the collision is beyond his power. He loses his prestige and power. The Frenchmen and the lama take over the palace and the machines. The comet is diverted to the Moon and, colliding with it, imparts to it a new supply of energy. After this, however, the machines in the mountains explode and one of Zagan's followers is thrown to the Moon in the chamber of a machine by the force of the explosion.

The entire installation for altering the path of the comet consisted of three parts:

1. Power generator.
2. Ray generators.
3. Machines directing the rays at the comet.

Power generator

The wind served as the source of energy. The cold air of Northern Siberia flowed into the barometric low in the Karasu-Togol Mountains, accelerating to hurricane speeds. The wind drove gigantic turbines producing electricity.

Ray generators

Electric current coming from the Karasu-Togol Mountains passed into the engine room of the Karakorum palace. Here the electric energy was stored in banks of durable glass tubes containing rarefied air, and produced

(126)



FIGURE 63. Machine altering the comet's motion

"cathode rays." The cathode rays were directed to the third stage in the Karasu-Togol Mountains. Moreover, the same generators produced ultra-red rays, which enveloped the equipment in the mountains with a kind of a net, impenetrable to strangers and foreign objects.

Machine directing the rays at the comet

At great altitude, in the zone of permanent snows of the Karasu-Togol Mountains, an ice disc of a large diameter was set up. A mirror-smooth surface was constantly maintained by a huge lever which moved over the disc like a hand of a clock and polished its surface (Figure 63). A pylon rotating together with the surface-sweeping lever rose in the center of the disc. Above the pylon there was a huge stationary spherical metal chamber, supported on large-span trusses stretching

over the disc and abutting against the mountains. The cathode rays transmitted from the central station in the palace fell into this sphere and were focused on the smooth surface of the disc.

126 Only the orange rays were reflected from the disc; they acquired oscillatory motion, propagating not only in the atmosphere but also through the interstellar ether. These oscillations displace the ether, creating a vacuum. Thus, a kind of a vacuum tube is created, stretching from the Earth into outer space.

In this way we can attract or "suck in" asteroids and comets, and in particular Swanley's comet.

The smooth ice disc is not stationary. It can be turned to direct the reflected rays at the comet, regardless of its actual position in the sky.

The Earth is rescued from the comet

When the comet ceased to be an Earth satellite and began to fall to Earth under the effect of the vacuum tube controlled by Khan Zagan, the Frenchmen seized control of the Khan's equipment and decided to deflect the comet from its path in order to save the Earth. They turned the mirror-disc, creating a vacuum channel on the side of the planet, and thus deflected the trajectory of the comet. Besides, Wang Tsao's mystical influence enhanced the deflection, as his powerful will was striving to do so.

As a result, the comet missed the Earth and on its way collided with the Moon, developing on impact enough energy to revive that dead body.

The volcano whose crater accommodated the disc and the other machines erupted and these machines along with Khan Zagan's assistant were ejected to the Moon.

3. CREATION OF NEW PLANETS

Man's vision reaches ever further into the future. Man even dreams of creating new planets which, as satellites, will revolve around the Earth. Such planets should be hermetically sealed airtight bodies, capable of accommodating people, supplies, engines, etc. They are assembled and equipped by means of rocket ships which lift all the materials from the Earth
127 to a required position in space and impart a necessary velocity to the newly built satellites. Such spacecraft satellites of the Earth have been described by Jules Verne, Tsiolkovskii in his novel "Beyond the Earth,"* Max Valier, and others. Here is a description of such an artificial planet from V. Nikol'skii's novel "In a Thousand Years."

An artificial Earth satellite

Engineer V. D. Nikol'skii, following Tsiolkovskii's ideas in his novel "In a Thousand Years," describes how the people in the thirtieth century, using powerful spacecraft, created a small planet, a new Earth satellite, which was used for astronomical observations and for solving other scientific problems. This tiny moon, named Urania after the mythological goddess of astronomy, was 12,000 km away from Earth and completed its orbital revolution in approximately $5\frac{1}{2}$ hours.

* A separate book in this series is dedicated to Tsiolkovskii's work and spacecraft.

It was an oval, oblong body* of silvery metal, about two kilometers long, with large windows through which green vegetation and narrow roads with a few pedestrians were seen. Two gigantic transparent domes hiding telescopes with 150 m objectives projected from the main body of the artificial Earth satellite. Inside the satellite there were lodgings, orchards, gardens, laboratories, all the necessary equipment, engines, and large supplies of air, food and energon, a special substance generating power, light and heat. The telescope is always automatically aimed at the observed target; this is attained by appropriately turning the planet itself.

Creation of matter according to A. Tolstoi

A. Tolstoi, in his novel "Engineer Garin's Hyperboloid," describes a method of creating matter from energy:

"Streams of energy (light rays in plain language) or streams of quanta move in all directions in outer space. There are points at which these streams intersect. What happens? Energy becomes progressively denser at this point, since each second more and more quanta pass through it. And then, somewhere at the focus of intersection, the energy intensity becomes material — energy is compressed into matter." A material particle is created.

128 Mohammed, the Moon, and the Sun

The Koran relates that Mohammed once cut the Moon in half before the whole people. It also relates that as a result of Mohammed's prayer, God ordered the Sun to stop, as in the times of Joshua, so that the prophet could carry out the deed for which Ali did not wake him in time, seeing that he fell asleep kneeling.

* A drawing was published in N.A.Rynin's "Spacecraft in Science Fiction." — Priroda i Lyudi, No.7, p.107.

WHEN WILL MAN REACH OTHER PLANETS?

"Our planet is nothing other than an ethereal ship transporting souls across the fathomless heavens at a speed of 2.5 million kilometers in a day around its guiding star and together with it streaking across 460 million versts of space each year."

C.Flammarion. "In the Heavens," p.230*

"Like all living things, worlds which have served as a place of habitat for higher life and ideas eventually disintegrate — grow old, fall into decrepitude, die, and finally become, as it were, wandering tombs, whirling amid the silent deserts of eternal night."

C.Flammarion. "Popular Astronomy." *

"The coming moment should particularly disturb us, the immortals, living the life of a planet. We are to leave the Earth which was our cradle but is not to be our grave, break thousands of ties with it and in another world search for a new home."

V.I.Kryzhanovskaya. "Death of a Planet."

"Then the Sun grew pale, blackness became still tighter and darker, and the great motor of life forever disappeared for Earth."

V.I.Kryzhanovskaya. "Death of a Planet."

1. STRUGGLE FOR EXISTENCE AND METHODS OF SOLVING THIS PROBLEM

It is very hard to foretell when mankind will find ways of leaving the Earth, penetrating into interplanetary space, and establishing communication with other planets. Probably, the first attempts will be to send from Earth unmanned missiles, then there will be some bold-spirited pioneers who, maybe at the cost of their lives, will explore interplanetary space, until, finally, a method will be found to establish convenient and safe communication with other planets.

What is it that makes man strive to penetrate the unknown outer space and try to reach the nearest planets? At the present moment, we can envisage the following reasons for it: scientific curiosity, i.e., a desire to
130 widen the horizons of human knowledge, to discover new worlds, to make new explorations, to enrich the store of human knowledge. Incidentally, it is also done for sporting reasons. However, one more reason may

* [Retranslated from the Russian.]

eventually compel mankind to seriously take up the problem of interplanetary communications. This may come when the human population on Earth reaches a point where there are insufficient means for further reproduction, when all the energy resources are used up, and when mankind is faced with a terrible question: how to ensure the possibility of future existence for himself and for posterity.

There are many ways to solve this problem. The simplest solution, which at the same time is the least worthy of intelligent beings, would be to escalate large-scale bloody wars which would exterminate the extra population and thus prolong the existence of the rest of mankind. This is the method used so far by modern man (the example of the last World War) although he has not used up so far for peaceful purposes the energy resources on Earth under his command.

Another, similarly unworthy method would be to pass a law, as in ancient Sparta, ordering the extermination of the weaker part of each newborn generation, thus stopping the growth of population.

The first two methods are negative in approach.

Another method is to try to find new energy resources on Earth, which ensure a high return on a small investment of power. If man managed to split the atom with little expenditure of energy and thus release the tremendous interatomic energy, this problem would be solved for a long time.

The exploitation of various kinds of energy on Earth has been a point of interest to novelists for a long time now.

Some authors see the solution in producing food by chemical means and manufacturing clothing from minerals. Eventually people will have to move to underground and underwater homes because of the lack of space on Earth. The underwater population adapting to the new conditions of life would learn to live and swim like fish, etc.

Finally, another possible solution would be large-scale emigration from Earth into interplanetary space and exploitation of energy resources in outer space (solar energy) and on other planets. It is this approach that will compel man by virtue of iron necessity to search for ways and means of interplanetary communications and man's genius will definitely find a solution to this problem.

Let us try, though very roughly, to fix the epoch when the emigration from Earth is likely to begin.

131 Let us examine the following factors:

1. Human reproduction rate on Earth.
2. Existing and replenishable energy resources on Earth.
3. Balance of energy on Earth and the epoch when mankind will have used up all the resources and will thus be forced to emigrate into interplanetary space. A reservation should be made that the following argument is not at all final, since it is difficult to determine mankind's future needs and the total energy resources on Earth. Our analysis therefore only provides an approximate pointer to the critical epoch.

Tsiolkovskii's view of life in the year 2017 follows.

"The entire Earth was ruled by one body: the Congress consisting of representatives of all states. It had existed for over 70 years and settled all the problems of mankind. Wars had been eliminated. Conflicts between nations were settled by peaceful means. Military forces were very limited; they were more appropriately called labor forces. The population,

under exceptionally favorable conditions, had tripled in the past 100 years. Commerce, technology, art, and agriculture developed in great strides. Huge metal dirigibles lifting thousands of tons made communication and transport of goods convenient and inexpensive.

Particularly beneficial were the huge airships rafting with the wind, for next to nothing, inexpensive cargo such as wood, coal, metals, etc.

Airplanes served as a fast means of transportation for small numbers of passengers or valuable cargo; airplanes for one or two passengers were particularly common.

Mankind was peacefully advancing along a road of progress. However, a rapid population explosion alarmed all intelligent people and the rulers.

Mentally penetrating into the perspective of the future millions of years, we may be faced with a question, what will mankind do when the Sun begins to dim gradually and its energy is exhausted? Will man also vanish? Or will he find means of salvation, including new resources and new places to live?

Solving the last problem is the task of future generations. We are only faced with the first problem, i.e., emigration to other planets in consequence of the depletion of energy resources of life-sustaining energy on Earth.

132 2. HUMAN REPRODUCTION RATE

Table 1 shows the approximate growth of population on Earth by years from A. D. 0 up to 1924; data for the future are roughly estimated.*

TABLE 1. World population by years in billions of people

Year A.D.	Number of people in billions	Year A.D.	Number of people in billions
0	0.08	1900	1.8
500	0.10	1924	2 *
1000	0.15	2000	4
1500	0.25	2085	7.4
1600	0.30	2165	14.8
1700	0.45	2200	30
1800	0.8	2300	100 **

* R.Laemmel's number of 1924 in his book "Physik für Jedermann" is 1.7064.

According to the Scientific Research Institute in Melbourne this number is 1.850 (Vest.Znan., 1926, No.1, p.10).

** Corresponds to three times the density of the present population of Belgium.

* The figures in Table 1 and many basic data for the following calculations are borrowed from the book "Black, Red, Yellow, and White Coal" by Prof.B.P.Veinberg, Leningrad, 1925.

For the details of population growth on Earth, see the article "The Menace of Increasing Population." (Scientific America, 1928, p.338).

The above data are represented graphically in Figure 64 by a continuous curve. The figure shows a sharp increase in population in the last centuries and the probability of further increase as special living conditions improve and become easier. Already at the present time the population of the Earth reaches 2 billion, in the year 2000 the expected number will be 4 billion, in 2200, 30 billion and in 2300, 100 billion.

What then are the means for maintaining such a population alive? To answer this question, it is necessary to examine the kinds of energy available to man.

133

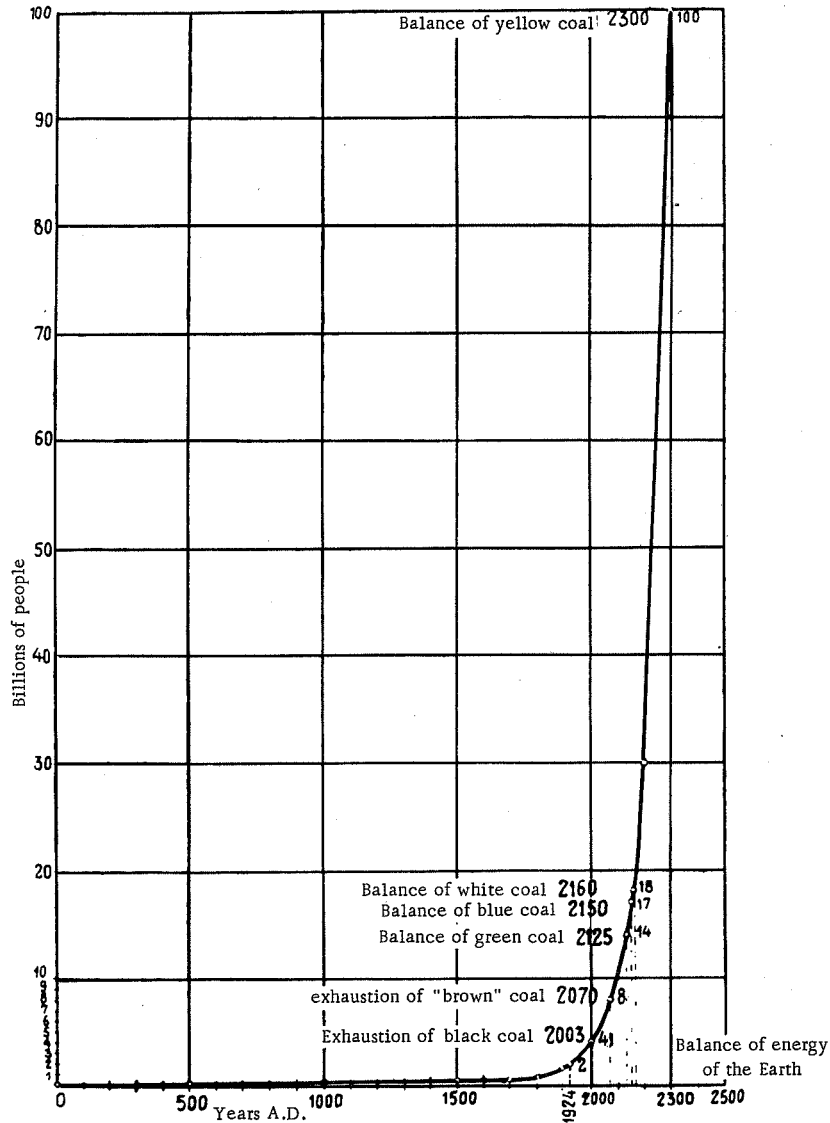

FIGURE 64. Balance of energy and the increasing population

134 3. EXISTING AND REPLENISHABLE ENERGY RESOURCES
ON EARTH

The energy resources are identified in the following way:

- a) black coal – different sorts of coal;
- b) brown coal – petroleum;
- c) green coal – plants and peat;
- d) white coal – the energy of flowing water and waterfalls;
- e) blue coal – wind energy;
- f) red coal – animal energy;
- g) pale-yellow coal – lunar and solar tides;
- h) yellow coal – the Sun;
- i) orange coal – the interior heat of the Earth.

The yellow coal, i.e., the Sun, is the immediate reason for the existence and the formation of the white and the blue coal, which would cease to exist if the Sun went out. After the extinction of the Sun, mankind still could use up the remaining reserves of the black, brown, green and red coals, if there is air left. As long as there is Sun, however, reserves of the green and the red coal may be replenished. Reserves of the black and the brown coal, on the other hand, are renewed very slowly, and are regarded as nonreplenishable.

Let us examine the time of exhaustion of each of these types of coal separately, depending on the increasing population and its needs.

a) Black coal

The known black coal resources on Earth, according to R. Laemmel,* are currently 972 billion tons. According to Svante Arrhenius and the data of the XII Geological Congress the total coal resources are 7,300 billion tons, according to Laemmel 10,000 billion tons, according to B. Veinberg 15,000 billion tons.

Accepting the last figure, let us see how long this supply will last.

We make two assumptions: 1) coal production and consumption will increase at the same rate as until now, i.e., approximately double every 18 years, and 2) coal consumption per capita will be limited to 4 kW energy, the amount consumed presently in the U.S.A. Taking 1 kW = 1.36 hp = 1.36 · 75 = 102 kg-meter and assuming that 1 kg of coal produces 6,000 calories or 6,000 × 427 kg-meter of work at an efficiency of 0.2, we see that 4 kW (sec) 135 corresponds to the following consumption of coal per capita per year:

$$\frac{4 \cdot 102 \cdot 365 \cdot 24 \cdot 60 \cdot 60}{0.2 \cdot 6,000 \cdot 427} = 25 \text{ tons}$$

First assumption. Table 2 lists production and consumption of black coal on Earth by years.

* R. Laemmel. "Physik für Jedermann."

TABLE 2. Production and consumption of black coal by years

Year A.D.	Coal production in billion tons	Consumption per capita per year in tons	Remarks
0	0.002	0.002	° According to B.Veinberg
500	0.003	0.005	
1000	0.005	0.009	
1500	0.008	0.012	** According to S.Arthenius
1600	0.009	0.014	
1700	0.015	0.018	
1800	0.020	0.030	According to R.Laemmel
1875	0.290	-	
1897	0.632	-	
1900	0.700	0.390	†† According to Stat.Jahrb. f. d. Deutsch. Reich.
1903	0.681		
1905	0.894		
1908	1.056		
1910	1.082		‡ Vestnik Vozdushnogo Flota, 1924, No.12, p.31.
1912	1.196		
1913	1.317	-	
1914	1.186		
1915	1.160		
1916	1.239		
1917	{ 1.360 1.302		
1918	1.308		
1921	1.16	-	
1924	{ 1.127 †† 1.251 †	-	
1924	2.000 *	1.000	

136 Table 3 shows the rate of gradual depletion of black coal, assuming that the coal consumption is doubled every 18 years.

TABLE 3. Projected consumption of black coal in future years

Year A.D.	Consumption of coal per year in billion tons	Cumulative consumption since 1924 in billion tons
1924	2	2
1942	4	54
1960	8	162
1978	16	378
1996	32	810
2014	64	1,674
2032	128	3,702
2050	256	6,858
2068	512	13,430
2070	570	15,000

From Table 3 it follows that, according to the first assumption, the resources of black coal will be exhausted by the year 2070.

Second assumption. Table 4 shows the consumption of coal in future years, taking the rate of consumption to be 25 tons per capita per year (or 4 kW).

TABLE 4. Projected consumption of black coal in future years

Year A.D.	Population (in billions)	Consumption of black coal (in billion tons)	
		per year	cumulative consumption since 1824
1924	2	2	2
1950	2.5	63	747
2000	4	100	4,822
2050	6	150	11,072
2070	8	200	16,000

137 Table 4 leads to the same conclusion as Table 3, i.e., the black coal resources will be exhausted by the year 2070, although initially the rate of consumption is higher than under the first assumption.

Note. According to the data of the First World Power Conference (London, 1924), if the present rate of coal consumption is maintained, the resources will last for 2,000 years, in England for 500 years (V. Karpov. "Vetrostilovye ustanovki" (Wind-driven Plants),* Leningrad, 1927, p. 1).

b) Brown coal

Petroleum or "brown" coal resources on Earth amount, according to S. Arrhenius, to 100,000 million calories, which is equivalent to 10 billion tons if the calorific power of petroleum is 10,000 cal per 1 kg.

Table 5 shows oil consumption by years according to S. Arrhenius and M. Dubenskii.

138 Taking the future increase of consumption per decade to be 0.03 billion tons, we draw up a table of oil consumption for future years.

TABLE 6. Projected oil consumption in future years (in billion tons)

Year A.D.	Annual consumption	Cumulative consumption since 1918
1918	0.078	0.078
1928	0.100	0.97
1938	0.130	2.12
1948	0.160	3.57
1958	0.190	5.32
1968	0.220	7.37
1978	0.250	9.72
1980	0.256	10.00

It follows from Table 4 that the 10 billion tons of oil resources will have been exhausted by 1980. (According to M. Dubenskii the oil will be exhausted by 1964).

* According to B.Veinberg.

(137)

TABLE 5. Oil consumption by years

Year A.D.	According to S.Arrhenius			According to M.Dubenskii* (in billion tons)		
	consumption (in billion tons)	consumption increase in different periods	consumption per capita per year (in tons)	period	average per year for a decade	Total production (in billion tons)
1860	0.000076	1869/70 0.00067	—	1860/60	0.00048	0.0046
1870	0.00074	1870/80 0.00330	—	1870/79	0.00182	0.0182
1880	0.0040	1880/90 0.00700	—	1880/89	0.00621	0.0621
1890	0.0110	1890/900 0.00900	1900 — 0.0112	1890/99	0.01566	0.1566
1900	0.0202	1900/12 0.02700	—	1900/09	0.03317	0.3317
1905	0.026	—	—	—	—	—
1911	0.082	—	—	—	—	—
1912	0.0469	1912/18 0.03100	—	1910/19	0.06466	0.6166
1913	0.0523	—	—	—	—	—
1914	0.0546	—	—	1920	0.10502	0.10502
1915	0.0560	—	—	1921	0.11593	0.11593
1916	0.0617	—	—	1922	0.12893	0.12893
1917	0.0670	—	—	1923	0.16682	0.16682
1918	0.0780	—	1918 — 0.0300*		Total	1.6362
1920	0.0985	—	—			
1923	0.133	—	—			
1925	0.142	—	—			

* M.Dubenskii. "Ocherki po ekonomicheskoi geografii Zakavkaz'ya" (Essays on the Economic Geography of Transcaucasia). Tiflis, 1924, p. 229-232.

Assuming a fixed consumption of 0.04 tons per capita per year, the resources will last until the year 2003, as it follows from Table 7.

TABLE 7. Projected oil consumption in future years (in billion tons)

Year A.D.	Population (in billions)	Annual oil consumption	Cumulative consumption since 1918
1918	1.9	0.078	0.078
1924	2.0	0.080	0.672
1950	2.5	0.100	3.012
2000	4.0	1.160	9.512
2003	4.1	0.165	10.000

The total consumption per capita is 0.053 tons, if all the oil reserves are exhausted by 2003 and the consumption per capita per year is on the average 0.04 tons.

c) Green coal

Existing resources. Assuming $\frac{3}{5}$ of the dry land* to be covered with forests and meadows and $\frac{1}{30}$ to be plowed fields, and assuming that on the average plants absorb $\frac{1}{600}$ of the total solar energy reaching them in daytime during the vegetative period, Veinberg calculates that plants transform into chemical energy $\frac{1}{7000}$ of the total energy of the Sun** reaching them, i.e., 25 billion kW.

This "vegetative energy" has three different destinations: as food for man and animals, for heating and in technological processes, for generation of mechanical energy in machines. This distribution is shown by years in Table 8.

TABLE 8. Distribution of green coal energy by year (in billion kW)

Year	1800	1900	1920	Probable in the year 2000
Purpose:				
Plants—food for man and animals	0.700	1.300	1.500	2.000
Plants—heating and technology	0.400	1.500	1.800	5.000
Mechanical energy for machines	0.0001	0.002	0.005	0.100
Total	1.001	2.802	3.305	7.100

* The surface of the Earth is $510 \cdot 10^6 \text{ km}^2$. Dry land accounts for 29%, i.e., $147 \cdot 10^6 \text{ km}^2$, and water for 71%, i.e., $363 \cdot 10^6 \text{ km}^2$.

** According to K. Tsiolkovskii 1/5000 "Dreams of Earth and Heaven," p.57 and 126). According to certain data the nonrenewable reserves of peat are assumed to be 215 billion tons, the renewable peat 50 billion, wood 340 billion and straw 37 billion tons.

Given the above area covered with vegetation, a consumption of 25 billion kW may be considered as constantly replenishable. Accepting the average consumption of green coal per capita to be 1.75 kW, we find that the yearly green coal production by the Sun will be totally used up by the population when it reaches $25/1.75 = 14$ billion people. According to Figure 64, this corresponds to the year 2130.

Professor P. Shteinberg, in his article "Chelovechestvoppered ugrozoi golodnoi smerti" (Mankind Facing the Threat of Death from Starvation) (Vestnik Znaniya), 1926, No. 1, p. 10, approaches the problem more optimistically and suggests that improved agricultural methods, on the one hand, and possibly a lower rate of increase of the population, on the other, will prevent the catastrophe.

In another estimate, K. Tsiolkovskii suggests that 1 square meter of surface outside the Earth's atmosphere, on condition that it is perfectly cultivated, may receive enough solar energy to feed one man (K. Tsiolkovskii, "Issledovanie Mirovykh Prostranstv" (Exploration of Outer Space), Vestnik Vozdukhoplavaniya, No. 5, p. 4, 1912).

Supposing that the cross-sectional area of the Earth is $3.14 \times 64.00^2 \times 10^6 = 129$ billion meters square and that the dry land accounts for 20% of this area, the energy obtained in the absence of an atmosphere can feed about 26 billion people. However, taking into account the absorption of radiation by the atmosphere, its scattering in space, etc., it is doubtful whether even with the best of crops one can obtain more than 50% of the above figure, i.e., to feed about 13 billion people, when the entire area covered with forests, mountains, swamps, meadows and deserts is cultivated and transformed into fields with highly cultivated fodder plants.

d) White coal

The energy of white coal or flowing and falling water is determined by B. Veinberg in the following way:

If the average elevation of continents is 440 meters, and the mean quantity of atmospheric precipitation is 0.90 meters per year, then if the precipitation is completely utilized, its power would reach 18 billion kW. The fact is though that it will hardly ever be possible to harness more than 0.1 of that power, namely 1.8 billion kW. For the time being only about $1\frac{1}{2}\%$ of that power is used. Veinberg's assumptions are compared with those of other authors in Table 9, showing the white coal resources on Earth. White coal consumption by years is shown in Table 10.

141 Assuming that the consumption of 0.1 kW per person is the maximum, then 1.8 billion kW will have been exhausted by the time the population reaches $1.8/0.1 = 18$ billion, which according to the figure corresponds to the year 2160.

Among the projects for obtaining new energy sources, the proposal of the German engineer Zargel should be noted. He suggests that if the Mediterranean is dammed up from all the sides, i.e., near Gibraltar, the Dardanelles, at the mouth of the Nile, etc., then the tremendous evaporation

will lower the water level by 165 cm annually. This decrease is to be replenished with water coming from the ocean, the Dardanelles, and the rivers.

140 TABLE 9. White coal resources on Earth (in billion kW)

Continents	Utilized, according to R.Laemmel (1924)	Projected resources (in billion kW)			
		according to Svante Arrhenius	according to R.Laemmel, 1924	according to B.Veinberg, 1924	according to Beumkehr
Europe	0.01000	0.048	0.063		
Asia	0.00270	0.173	0.058		
Africa	0.00400	0.118	0.050		
America	0.01090	0.187	0.057		
Australia	0.00010	0.022	0.012		
Total	0.02776	0.548	0.240	1.800	0.288
	0.017 according to Beumkehr		by other assumptions, 0.400		

TABLE 10. White coal consumption by years (in billion kW)

Year A.D.	Consumption according to Veinberg	Consumption according to R.Laemmel	kW per capita
1800	0.0002		0.00025
1900	0.0010		0.00056
1920	0.0150		
1924		0.02776	0.01388
2000 (probable)	0.400		0.10000

By exploiting the level difference, very powerful hydroelectric power stations may be obtained. For example, a 200 meter level difference will generate a power of half a billion hp, and a difference of 25 meters up to 65 million hp.

e) Blue coal

Blue coal, or the energy of moving air, derives from pressure differences between adjacent parts of the atmosphere. B. Veinberg suggests that if all the solar energy absorbed by air between the upper limits of the atmosphere and the surface of the Earth and all the thermal energy which is radiated by the hot Earth's surface and absorbed by the upper air layer were transformed into the kinetic energy of air movement, it would amount to 6,000 billion kW. Swerdrup (according to S. Arrhenius) thinks, however, that only $\frac{1}{20}$ of this power is converted into the energy of air currents, which amounts only to 300 billion kW. But this energy cannot be utilized since it

spreads vertically throughout the entire atmosphere. Therefore, B. Veinberg suggests that only part of the energy may be exploited at the ground by setting up windmills 40 meters in diameter at distances of 200 meters from each other. These windmills will produce 120 kW per 1 square kilometer, which amounts to 17 million kW* for the entire dry land area when the wind intensity is 5 m/sec.

TABLE 11. Blue coal consumption by years

Year A.D.	Billion kW	kW per capita
1800	0.0001	0.00013
1900	0.0002	0.00011
1920	0.0003	0.00016
2000 (probable)	0.2000	0.05

142 Although it follows from Table 11 that the blue coal consumption per person is gradually increasing, we shall stop at 0.05 kW per person. Then the total reserves of 17 billion kW will be exhausted when the population reaches $17/0.05 = 340$ billion people.

When the coal, oil, plant, and water energy reserves have been exhausted, however, the consumption of blue coal will rise. Even if the rate of consumption will be only 1 kW per person, we see that the total reserve corresponds to 17 billion people or, according to Figure 64, to the year 2150. If the consumption per person will be greater, the total reserve will suffice for a smaller number of people and the "blue" coal hunger will strike sooner.

Note that air can supply nitrogen as an artificial fertilizer and atmospheric electricity may also be utilized.

f) Red coal

Red coal is the energy produced by man and by animals. Let us estimate the magnitude of its reserves.

The red coal of animals is delivered to man either as food or as mechanical work performed by the animals. Animals, in their turn, receive energy from the plant kingdom and from various chemical compounds of air, water and soil.

Approximate figures for the energy supplied by animals (according to B. Veinberg) are given in Table 12.

It is apparent from Table 12 that the importance of animals is gradually decreasing. Man's reliance on them as a source of food and mechanical work is diminishing and in the future man will probably learn to manage without animals altogether.

The red coal of man. In order to live and to do work necessary to sustain future life, man spends a certain amount of energy which is made up with food.

* According to TsAGI [Zhukovskii Central Aero-Hydrodynamic Institute] calculations — 475 kW per 1 sq meter and $147 \cdot 10^6 \cdot 1.085 \cdot 10^6$ kW over the entire dry land area.

For internal body processes alone, not doing any external work, man burns 2,000 calories a day, which corresponds to 0.0969 kW. Under conditions of low-intensity physical work (for 8 hours a day), man produces external work equal to 0.00624 kW while consuming the equivalent of 0.1271 kW in food. Doing very hard physical work, man produces (working 8 hours a day) 0.0153 kW per day, consuming 0.2234 kW in food.

TABLE 12. Consumption of red coal of animal origin by years

Year A.D.	Billion kW	kW per capita
1800	0.008	0.010
1900	0.014	0.0078
1920	0.016	0.0084
2000 (probable)	0.020	0.0050

143 TABLE 13. Red coal of human origin (in billion kW)

Year	1800	1900	1920	1924	2000	2300
1. Population (in billions)	0.8	1.8	1.9	2.0	4.0	100.0
2. Population not producing external work (in billions)	0.4	0.9	0.95	1.0	2.0	50.0
3. Internal energy absorbed by the population (0.0969 kW, per person) (in billions)	0.039	0.087	0.092	0.097	0.194	4.84
4. Population producing external work (in billions)	0.4	0.9	0.95	1.0	2.0	50.0
5. Internal energy consumed by the population when doing moderate work (0.1271 kW per person)	0.051	0.114	0.121	0.127	0.254	6.36
6. External energy produced by the population (0.00624 kW per person) in billion kW	0.0025	0.0056	0.0059	0.006	0.012	0.31
7. Total energy when doing moderate work (in billion kW) { internal (items 4 and 6) external (item 7) ...	0.090	0.201	2.213	0.224	0.448	11.20
8. Internal energy consumed by the population when doing very hard physical work (0.2234 kW per person) (in billion kW)	0.089	0.201	0.212	0.223	0.447	11.17
9. External work produced by the population when doing very hard physical work (0.0153 kW per person) (in billion kW)	0.006	0.014	0.015	0.015	0.030	0.765
10. Total energy when doing hard physical work (in billion kW) { internal (items 4 and 9) ... external (item 10) ..	0.128	0.288	0.304	0.320	0.641	16.01
	0.006	0.014	0.015	0.015	0.030	0.765

Table 13 presents estimates of the external energy developed by people and of food consumed by years. The fact that external work is not performed by children and by old people has been taken into account in this estimate; their number is estimated to be half the population.

For further calculations we accept that the mean energy consumed per person is $(0.0969 + 0.2234) \cdot 2 = 0.16 \text{ kW}$.

g) Pale-yellow coal of the Moon and the Sun

The mechanical effect of the Moon (and the Sun) upon the Earth is reflected in tidal phenomena. In terms of tidal energy the effect of the Moon is $2^{1/2}$ times as strong as that of the Sun. The strongest tides occur during the conjunction or the opposition of the Moon and the Sun, and the weakest tides are observed during the quarters. The ratio of the highest to the lowest tidal energy is $3^{1/2}$ to 1. Assuming the largest mean difference between the high and the low sea level to be 0.74 meters at the equator and 0 meters at the poles, the mean oscillation amplitude of the water level is 0.37 meters.

Although the area of the water is $393,260,000 \text{ km}^2$, only the coastal strip of the continents, (120,000 km long) may be utilized. Suppose that tidal installations were to occupy a strip 1 kilometer wide perpendicular to the shore; then the working tidal area of the sea would be $120,000 \text{ km}^2$. If the efficiency of the tidal machines is 0.3, then the tidal energy reserve is:

$$\frac{0.3 \cdot 0.37 \cdot 120,000 \cdot 1,000 \cdot 1,000 \cdot 4}{24 \cdot 60 \cdot 60 \cdot 75 \cdot 1.36} = 4 \text{ million kW}$$

This quantity is very small and is almost of no importance in the Earth's overall balance of energy. For example, in the year 2000, when the population reaches 4 billion, there will be only available 0.001 kW of tidal energy per person.

There is one more source of energy replenishment on Earth; this is the energy released by bodies of cosmic origin falling to Earth or penetrating into the atmosphere from outer space (shooting stars, fireballs, uranolites). According to a rough estimate by the American astronomer S. Newcomb, about 146,000,000,000 shooting stars fall to Earth annually. The weight of the material falling to Earth is about 876,000 kg annually, i.e., about 8,760 million kg in 100 centuries. The impact velocity of these bodies on Earth may reach 80 km/sec. The kinetic energy of the falling bodies is transformed into light and heat, but these forms of energy are difficult to estimate.

h) Yellow coal (of the Sun)

Yellow coal is the energy supplied by the Sun.

According to S. Arrhenius, the energy radiated by the Sun is expressed by the following figures:

Energy radiated into outer space $4 \cdot 10^{23}$ kW
 (Nordmann takes $9.75 \cdot 10^{20}$ kW)
 Energy reaching the Earth with its atmosphere $176 \cdot 10^{12}$ kW
 (Nordmann's estimate is $1.95 \cdot 10^{12}$ kW, Langley's
 estimate is $287 \cdot 10^{12}$ kW)

(Tsiolkovskii suggests that only 80 % of this energy is absorbed by the Earth, whereas the other 20 % is scattered and reflected into space).

Energy reaching the Earth's surface — $70.4 \cdot 10^{12}$ kW
 Energy reaching the dry land surface — $17.6 \cdot 10^{12}$ kW.

According to Langley, 1 sq meter of the Earth's surface illuminated by normal rays of the Sun produces 30 calories or 12,720 kg-meter per minute, and 0.5 calories or 212 kg-meter per second, i.e., almost 3 hp. The solar energy closer to the Sun will be correspondingly higher.

Let us consider the part of solar energy which falls on dry land in order to determine the part of the total $17.6 \cdot 10^{12}$ kW which may be usefully exploited.

If, following B. Veinberg, we assume that $\frac{1}{5}$ of the dry land area is covered by solar machines converting the solar energy into mechanical energy, that the efficiency of the machines is 20 %, and that half the time the weather is overcast, we obtain

$$\frac{17.6 \cdot 10^{12}}{5.2} \cdot 0.2 = 350 \cdot 10^9 \text{ kW.}$$

However, this 20 % of the energy includes both thermal and chemical energy. Figure 65 represents the energy distribution in the solar spectrum. From this figure we see that the chemical energy of the rays accounts for some 2 %—3 %. The lower figure (2 %) may be regarded as a source of food production from nitrous compounds of soil and air.

Thus, the mechanical work of the Sun will be $350 \cdot 10^9 = 315 \cdot 10^9$ kW, and the food-producing component is $350 \cdot 10^9 = 35 \cdot 10^9$ kW.

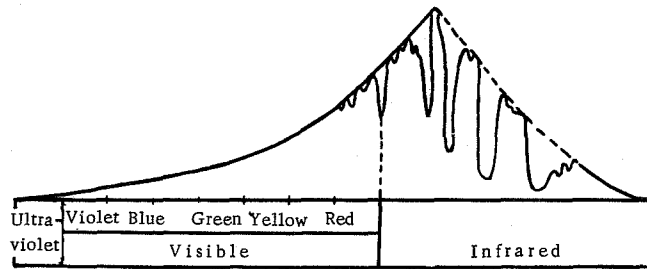

Energy distribution in the solar spectrum

3%	18%	14%	65%
Active chemical energy	Less active chemical energy and thermal energy	Thermal energy	

FIGURE 65

An artificial reduction in the reflection of the solar rays from the Earth may be achieved, say, by covering the oceans with rafts. According to Tsiolkovskii, this is one of a number of measures intended to improve the retention of the solar energy by the Earth.*

146 Sources of energy

We shall list two more methods of energy production on Earth, utilizing temperature differences.

One of them was suggested by the French engineers Claude and Boucherot, who suggested to producing energy utilizing the difference between the temperature of seawater of tropical seas on the surface (+ 28°C) and at a depth of about 2,000 meters (+ 4°C).

The other method, that of the French engineer Bargeau, is based on the same principle, the difference in Polar regions between average air temperature (-22°C) and water temperature (0°C). The substance driving the machines was to be the hydrocarbon butane (C₄H₁₀) which liquefies at -22°C and boils at -17°C. A relatively small amount of butane circulating between vessels of the mentioned temperatures (evaporator with a temperature higher than -17°C and freezer with a temperature below -22°C) can drive powerful turbines with its vapors.

i) Orange coal of the Earth

The name stands for the internal heat of the globe. Its core is still incandescent, and if man could utilize at least part of that heat, he would not need any fuel. Engineering, however, has not yet found a method of utilizing this heat, but there are isolated cases where nature itself suggests a solution, e.g., in Larderello (North Tuscany, Italy) where hot springs and steam coming from the earth through cracks were utilized. They drive a 10,000 hp steam turbine. A similar installation, but of 20,000 kW, is operating in Geldboro in California. However, if the energy of consumption of the orange coal is to be utilized on a large scale, deep mines (according to Parsons up to 20 km) must be sunk, and it is as yet too early to speak of widespread utilization.

There could also be other causes of depletion of energy resources on Earth. For example, Camille Flammarion points to a possibility that the

* K.Tsiolkovskii supposes that in interplanetary flight solar energy may be focused by special mirrors and lenses to provide temperatures from -273° to +6,000°. By transforming solar energy into mechanical or electrical energy, even 20,000° or more may be attained. (See K.Tsiolkovskii. "Dreams of Earth and Heaven," p.57 and 126). Meanwhile more humble results were achieved:

Geophysicist K.G.Trofimov in Tashkent built a special solar accumulator which, without lenses and mirrors, can raise the temperature to 200°.

To study the properties of the "solar energy," a special "Solar Institute" was built in the city of Slutsk, where a number of research projects are supervised by Prof.N.N.Kalitin.

amount of water and air will decrease. The ocean, as well as the
147 atmosphere, apparently were more extensive in the past. The Earth's crust
is pervious to water which combines chemically with rocks. Oxygen, nitrogen
and carbon dioxide which constitute the atmosphere also seem to be slowly
absorbed. It is very difficult however, to determine the time of exhaustion
of these reserves. Note that the radioactivity of rocks may also provide a
source of energy. For example, 1 gram of radium in equilibrium with its
decay products releases 130 calories per hour. A 16 kilometer layer of
the Earth's crust containing the average amount of radium and thorium
which is observed in the crustal rocks suffices to prevent the Earth from
losing heat by radiation to outer space.

Atomic energy

If man succeeds in releasing and utilizing atomic energy, he will never
be threatened with exhaustion of energy reserves and will actually
receive a new powerful impulse in its development. This problem, however,
presents unusual difficulties and at this stage only the general roads to be
followed toward the solution are sketched.

In this respect, the work of the Russian scientist G. A. Gamow* should be
mentioned.

Rutherford and his followers attempted (1919-1925) to affect the nucleus
by bombarding it with "alpha-particles" of radioactive substances and came
to the conclusion that fragments released by the bombarded atomic nuclei
carried "atomic" energy which was seldom greater, and often 15-20 percent
smaller, than the energy of the bombarding particles.

According to the "wave theory of matter," all phenomena taking place on
the atomic scale may be treated as wave oscillations whose wavelength is
close to the wavelength of X-rays. During the "alpha-bombardment" of the
atomic nuclei in Rutherford's experiments, an "alpha-wave" hits a complex
group of nuclear waves," which intersect in the minute nuclear space.
To such a mathematical study of "alpha-wave" distribution near atomic
nuclei was devoted Gamow's first (1928) work. He formulated the following
problem: if the alpha-bombardment is an encounter of two wave systems,
when does resonance take place between the two systems?

It seems logical to assume that in case of a resonance between the alpha-
waves and the nuclear wave structure, we will excite and break up the
nucleus, expending in the process a technically feasible amount of energy.

148 Gamow with the British physicist Fowler began developing this amazing
idea in January of this year and, as Gamow reports in the first, as yet
unpublished, results, it took on very clear theoretical outlines. Gamow's
mathematical research led to the conclusion that a resonance between an
alpha-wave and a nuclear wave complex is possible.

It now remains to calculate the frequencies of the alpha-waves ("the
velocities of the alpha-particles") corresponding to resonance. This is the
problem facing Gamow in his further research.

* [Gamow was born in Russia in 1904 and obtained his Ph.D. degree from the University of Leningrad in 1928.
He left Russia in 1933 and settled in the U.S.A. in 1934.]

If such resonance velocities could be experimentally achieved, the results would be amazing.

At present Gamow is working in the Rutherford laboratory in England where million gauss ultramagnets are being built. The 5,200,000 volt ultra-transformers built at the Carnegie Institute in America will also aid in solving this problem. Finally, the German physicists Brasch, Lange and Urban used an antenna stretched between two mountains near Lugano on the Swiss-Italian border to obtain in 1927 electric discharges of 2,000,000 volt intensity; the sparks were up to 5 m long. In 1928 they reached the intensity of 8,000,000 volts with current power of 32,000,000 watt. These experiments reveal interesting vistas and problems of atom bombardment and breakup.

Utilization of the Earth's cosmic power according to Bogdanov

Concern for future sources of energy on Earth often leads science-fiction writers into a blind alley, and makes them offer ridiculous solutions. An example of such an absurdity is the "utilization of the Earth's cosmic power" proposed by F. Bogdanov in his science-fiction novel "Born Twice."

This is how he describes his idea of obtaining powerful streams of electric energy:

An equatorial power station (EPS) was set up near the equator. It radiated energy in all directions through the air up to the fifth parallel to the north and to the south and over $\frac{3}{4}$ of the Earth's circumference along the equator. The operating principle of the station is the following.

The Earth turns on its axis with a speed of almost 5 km per second and travels around the Sun with a speed of 25 km per second. Both of these motions were harnessed by man's genius. Some 15 to 25 kilometers above the surface of the Earth, huge turbines were set up, turning in the direction opposite to the movement of the Earth with a force equal to the square root of the Earth's angular velocity (?) This force kept them aloft. The highly rarefied atmosphere nevertheless provided enough force to 149 spin the turbines with an incredible speed. The motion of the turbines was converted into electrical power which was distributed on Earth.

The huge dark turbines lined up in the air like soldiers created the impression of an infinitely powerful construction wrapped in nets with masts sticking out all around, like some imaginary multilegged monster. Tied by an invisible thread to Earth, they seemed to guard it from possible invasions from the depths of outer space.

4. THE BALANCE OF ENERGY ON EARTH AND THE IMMINENT MIGRATION TO OTHER PLANETS

The term "balance of energy on Earth" refers to an equilibrium between energy production and energy consumption. When this moment is reached, further increase of population must stop, as otherwise there will be

progressively less energy available per person, and the power shortage will lead to malnutrition and, finally, famine.

The above calculations are summed up in Table 14.

TABLE 14. Balance of energy in the future

Type of coal	Year of total depletion	Year of production-to-consumption equilibrium	Population in billions	Consumption per capita (in kW)	Total consumption per capita (in kW)
Black coal (fossil)	2070		8.0	4.0	} 4.053
Brown coal (petroleum)	2000		4.1	0.053	
Green coal (plants)		2125	14.0	1.8	} = 3 kW
White coal (water)		2160	18.0	0.1	
Blue coal (wind)		2150	17.0	1.0	
Red coal (animals)		2000		0.005	
Pale-yellow coal (the Moon)		2000	4.0	0.001	
Yellow coal (the Sun)		2300	100	5,000	5 kW
Orange coal	Large-scale consumption is a long time away in view of technical difficulties				

The dates in this table are shown in Figure 64.

Assuming, as before, that 0.16 kW are required to feed one person, and 5 kW for all other needs, which corresponds to the present-day needs of 150 urban population, we conclude that the solar energy will suffice to maintain the existence of the following population:

$$\text{chemical energy for } \frac{35 \cdot 10}{0.16} = 250 \text{ billion people,}$$

$$\text{mechanical energy for } \frac{310 \cdot 10^9}{5} = 63 \text{ billion people.}$$

If the dry land area is 126,740,000 square kilometers, the former number corresponds to a population density of 2,000 people per 1 square kilometer. In this case, however, there will be a shortage of mechanical energy, which is sufficient for 63 billion people only.

The latter number (63 billion) corresponds to a population density of 500 persons per 1 square kilometer. In this case, there would be a surplus of food and fairly generous reserves of mechanical energy. Admitting the possibility of a somewhat lower consumption of mechanical energy per person (less than 5 kW), the maximum population on Earth may be estimated at 100 billion people, giving a density of dry land population of about 800 people per 1 square kilometer, which in our graph corresponds to the year 2300 (for comparison, note that the population density in Moscow is 100,000 people per 1 square kilometer).

Thus, around the year 2300, depending on food resources and the availability of mechanical energy, mankind will have to consider

emigration into outer space to relieve the population pressure. This will mark the beginning of interplanetary travel.

THE END OF THE WORLD

"And I beheld when he had opened the sixth seal, and, lo, there was a great earthquake; and the sun became black as sackcloth of hair, and the moon became as blood."

"And the stars of heaven fell unto the earth, even as a fig tree casteth her untimely figs, when she is shaken of a mighty wind."

"And the heaven departed as a scroll when it is rolled together; and every mountain and island were moved out of their places."

Apocalypse, chapter VI, v.12-14.

Besides the above reasons for emigration to distant planets, other speculations also served as subjects of some novels.

151 **1. The fall of the Moon to the Earth.** This theme was developed by K. Laffert in his novel "Der Untergang der Luna." The novel is based on a hypothesis that the Moon, formerly an independent planet which had revolved around the Sun, turned into a satellite of the Earth; its orbital radius was gradually decreasing and finally it disintegrated into a multitude of fragments which fell to the Earth. As a result of earthquakes and floods, very few inhabitants survived on Earth.

2. Atomic fire. This theme was elaborated by Hans Dominik in his novel "Das Erbe der Uraniden." On one of the Pacific islands atomic fission is triggered and the temperature increases alarmingly. An "atomic fire" results. Attempts to put it out with water from the ocean lead nowhere. It is decided to cut out the "deceased" place and load it on an automatic space rocket which transfers the burning rock to the Moon. The Moon goes up in flames under the effect of atomic fission and turns into a small sun.

The fire on Earth does not stop, however, and the population must emigrate to other planets.

Wilhelm Bölsche, in his book "Komet und Weltuntergang," speculates on the future fate of the world and the possible causes of its destruction. He sees two ways by which the human mind may overcome upheavals in the planetary system, which threaten existence and even turn them to our advantage, into new stages of development.

The first way is to expand into outer space. Traveling at the speed of light, people will set out on board their remarkable spaceships to distant and happier star systems, maybe to the red double star Alpha Centauri which is only 4 trillion miles away from the Earth!

The second way allows for the possible disappearance of mankind's external form. However, the matter which passed for innumerable ages through the human brain, having resided in the heads of trillions of generations of intelligent beings, will have undergone profound changes. This cycle of brain matter will teach every atom a great lesson, which later will be manifested in a newly created world, from the very beginning, in the form of

absolute laws and definite assumptions. Thanks to this universal heritage, many things would be easier in the new world and thus the chain of development would be saved, evolution would not be interrupted. A new line of development, established on new principles, would come into existence.

We all have entertained the idea that even what we call the laws of nature are possibly a result of the infinitely long evolution and immeasurably slow processes imprinted in matter.

Some writers in their novels anticipated this idea of the evolution of matter.

V. I. Kryzhanovskaya in her novel "Magi" relates a legend about the fate of a Hindu sage Vaidhova who, after his death, ascended in an astral body to the center of the universe. There rose a dazzling bright wall beyond which Brahma's throne was located. When Vaidhova, in reward for his righteous life, asked to be allowed to stretch out before the throne and enjoy peace, his plea was denied and he was told to go and work again. 152 Outraged by the denial, Vaidhova started to mouth curses when, suddenly, the stars crowning his head fell apart with a thunderous noise, disgorging clouds of black smoke. A bright lightning spurted from behind the mysterious barrier and pierced his heart. His transparent body disintegrated into a thousand atoms. A hurricane of fire burnt his light-colored clothing, destroyed his memory, and deprived him of all knowledge and power. He was falling into an endless abyss until a terrible blow put a sudden stop to this mad fall.

Shattered and tormented by a terrible pain, Vaidhova ascertained with difficulty that he was imprisoned in a huge stone. Only a small, reddish flame, vibrating like a will-o'-the-wisp, remained from his dazzling light.

Now, in punishment for his pride, he was to undergo a long evolution for an infinite number of years: he was meant to be transformed from stone through all the three kingdoms of nature back into man.

A similar episode is described by V. Kryzhanovskaya in her novel "Zakonodateli" (The Legislators). Someone, in punishment for his villainy, was first transformed into lower animals, then into various species of plants, and finally into stone, so that after a great deal of suffering he would again slowly climb the steps of the ladder of evolution from which he had descended.

"But the powerful hand of the forces
Leads you to a mysterious target, of the universe,
Though, ignorant of any other fate,
You may not want to go."

N.Morozov. "Songs of the Stars." Vol.I, p.23

"... Last of the sky dwellers Maiden Astrea
Ascends from the earth covered with blood."

Ovid. "Metamorphoses." Book I, p.149

"And I saw a new heaven and a new earth; for the
first heaven and the first earth were passed away,
and there was no more sea."

"Apocalypse." Chapter XXI, v.1

This book presented the reader with many different ideas of scientists and writers, relating to interplanetary travel and communication. Which of these ideas will be the most fruitful for the solution of the problem?

The various rays, and particularly the cosmic rays considered in the first chapter, suggest that the time is near when man will be able to transmit energy without conducting wires and, maybe, special spacecraft driven by this energy will reach far beyond the Earth's atmosphere. If man succeeds in harnessing the energy of cosmic rays, wide perspectives will open for interplanetary travel.

The problem of signals and communication to other planets is now at a point where it is of interest to science-fiction writers only. Scientists (except for Goddard) have hardly given any thought to this question. If it becomes necessary to solve this problem, then radio waves or mixed-type waves will be used, first sending waves of one kind, to pave the way, so to speak, and then sending waves of another kind in the same direction.

With regard to altering the course of the planets, only science-fiction writers entertain this idea at the moment.

Finally, the migration or emigration to other planets is only outlined in general terms and the main factors which will compel mankind to examine more urgently and deeply the problem of interplanetary travel are brought to light.

