

March 5, 1946.

R. H. GODDARD

2,395,809

ROCKET DIRECTING APPARATUS

Filed Dec. 2, 1939

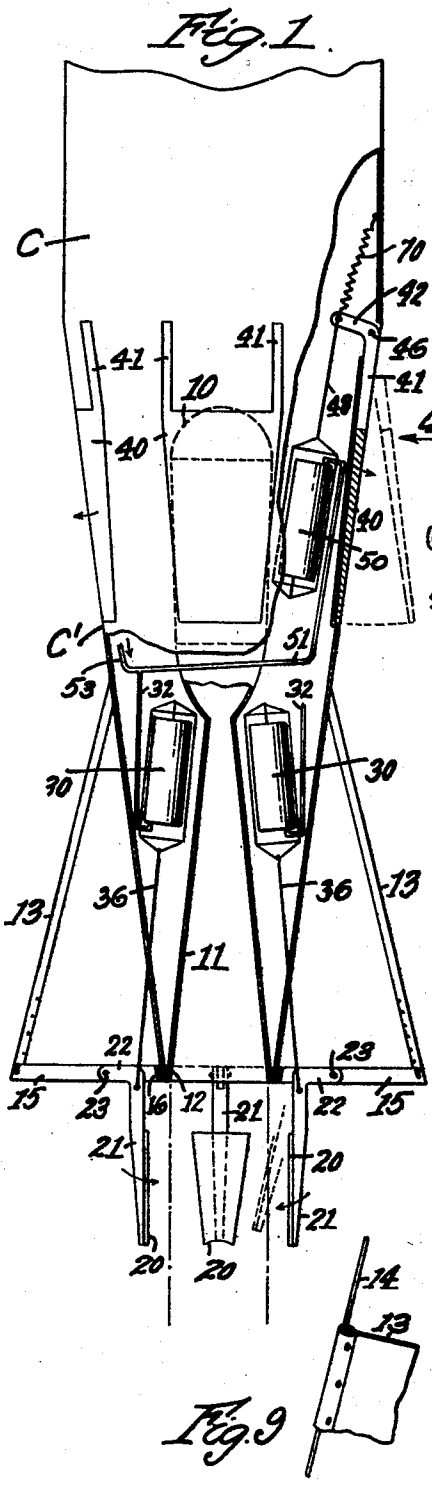

Fig. 1.

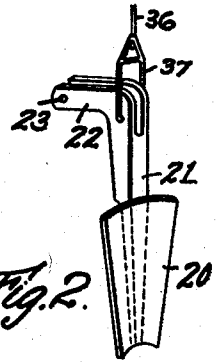

Fig. 2.

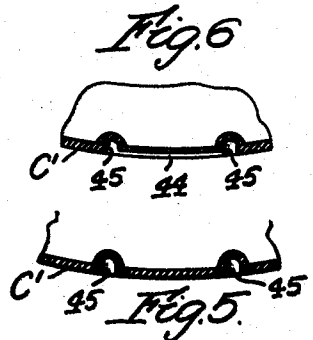

Fig. 6.

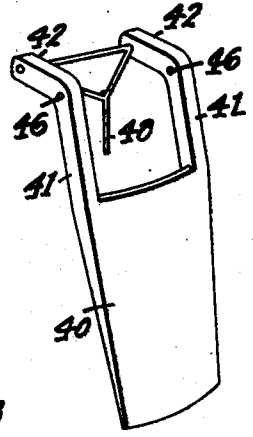

Fig. 3.

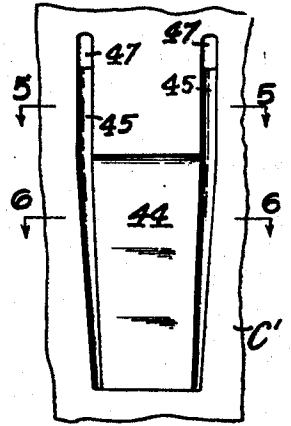

Fig. 4.

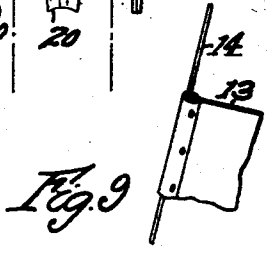

Fig. 9.

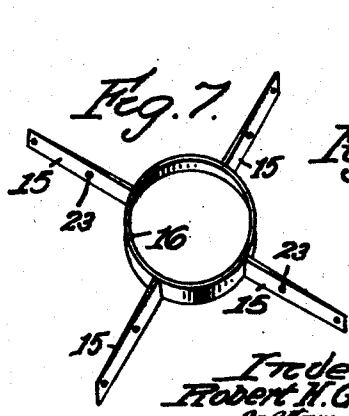

Fig. 7.

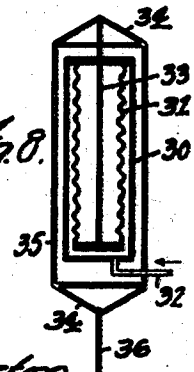

Fig. 8.

Inventor
Robert H. Goddard
By
Wm. G. Handley