

NASA
TT
F-640
v.1#2
c.1

N. A. Rynin

INTERPLANETARY FLIGHT AND COMMUNICATION

Volume I, No. 2

Spacecraft in Science Fiction

**LOAN COPY: RETURN TO
AFWL (DOUL)
KIRTLAND AFB, N. M.**

0069213



TECH LIBRARY KAFB, NM

TRANSLATED FROM RUSSIAN

Published for the National Aeronautics and Space Administration
and the National Science Foundation, Washington, D.C.
by the Israel Program for Scientific Translations

TECH LIBRARY KAFB, NM



0069213

N.A. Rynin

INTERPLANETARY FLIGHT AND COMMUNICATION

(Mezhplanetnye soobshcheniya)

Volume I, No. 2

SPACECRAFT IN SCIENCE FICTION

(Kosmicheskie korabli)

Leningrad 1928

Translated from Russian

Israel Program for Scientific Translations
Jerusalem 1971

NASA TT F-641
TT 70-50112

Published Pursuant to an Agreement with
THE NATIONAL AERONAUTICS AND SPACE ADMINISTRATION
and
THE NATIONAL SCIENCE FOUNDATION, WASHINGTON, D. C.

Copyright © 1971
Israel Program for Scientific Translations Ltd.
IPST Cat. No. 5813

Translated by R. Lavooft

Printed in Jerusalem by Keter Press

Available from the
U.S. DEPARTMENT OF COMMERCE
National Technical Information Service
Springfield, Va. 22151

Table of Contents

	Page
Foreword	1
Preface	2
CHAPTER I. From a Gun to the Planets	4
CHAPTER II. Hurling Machines	31
CHAPTER III. Flights with the Aid of Minus and Plus Matter	40
CHAPTER IV. Flights with the Aid of Radiation Pressure	60
CHAPTER V. The Use of Radiant Energy	80
CHAPTER VI. Electric Ships	85
CHAPTER VII. Radio Ships	95
CHAPTER VIII. The Use of Intra-Atomic Energy	106
CHAPTER IX. Rocket Ships	127
CHAPTER X. Inhabitants of Celestial Worlds	153
Conclusion	180

FOREWORD

The inquisitive human mind cannot be satisfied by established forms and laws of science, art, and life in general. Mankind constantly craves for new kinds of progress in every possible direction, and in this craving science, art, technology, and fantasy go hand in hand.

Things which yesterday appeared unfeasible and today seem doubtful may tomorrow become reality.

For example, Jules Verne in his remarkable novels describes submarines, dirigible airships, amphibian airplanes, and other products of technology which at that time were considered fantastic. Fact has now far surpassed his imagination.

One of the fascinating ideas which has preoccupied man since time immemorial has been the possibility of flight to other planets. Many writers and scientists have examined the question of whether it is possible to fly from Earth into space, whether man will some day reach the Moon, Mars, Venus, and other planets, whether there exist living organisms in worlds other than Earth, and if so what they are like and under what conditions they originate and reproduce, finally, if man himself has to remain earthbound, whether he can establish communication with inhabitants of other worlds by means of radio or light signals.

Many scientists, technicians, fiction writers and poets have, each in his own way, tackled this problem and found his own solution.

In the course of centuries and millennia many interesting fantasies and ideas have accumulated which at present constitute a vast store of valuable knowledge pertaining to the problems of interplanetary communications. At first this was a realm of pure imagination. In the last twenty or thirty years, however, as a result of a series of scientific and technical works, it has become possible to examine not only an imaginary solution to this problem but also a solution capable of realization. In the present book we deal only with the fantasies of recent fiction writers relating to this problem.

Although I have dealt with and prepared for publication other questions of scientific and technical nature, with spaceship calculations and designs, it is not possible to publish these at the present time for financial reasons.

In conclusion I wish to express deep gratitude to my publisher, P.P. Soikin, who readily agreed to publish this work and, through the large edition, promoted circulation among readers of the idea of interplanetary flight and communication which provoked a series of searching questions in the fields of astronomy, physics, mechanics, and technology.

Prof. N. Rynin

Leningrad, June 17, 1928



"Nobody ever traveled through the world unless he hoped some day to tell others what he had seen."

B. Pascal

PREFACE

Flights into space, visits to the Moon, the planets of the solar system and even other worlds have long been favorite themes of numerous works of fiction, especially in the last few years in connection with scientific investigations which have recently been undertaken. The fantasies of fiction writers offered a new scope unrelated to ordinary conditions. At the same time the possibility arose of a new kind of "scientific" work of fiction in which the author, skillfully interweaving scientific ideas with fantasy, could imperceptibly work on the imagination of the reader and carry him away to a new horizon, at the same time arousing in him curiosity and a longing to unravel for himself what is fact and what is invention, and how far it is possible to shift the bounds of human achievement.

In the following essays the reader is presented with a series of technical projects proposed by writers in their novels for flight into space. These essays are grouped in the following order, those in each group being linked by a general technical concept:

1. From a gun to the planets
2. From a volcano to the planets.
3. Missile-hurling centrifugal machines.
4. A take-off run along rails on the Earth.
5. Flights with the aid of minus and plus matter.
6. Flights with the aid of radiation pressure.
7. Application of the vibrational force of the ether.
8. Utilization of solar energy.
9. Electric ships.
10. Radio ships.
11. Utilization of intra-atomic energy.
12. Rocket ships.

Finally, we introduce a description of landscapes and portrayals of inhabitants of other worlds, as these are presented by various authors, either coming from the inventions of their imagination or based on reasoning concerning the possible forms of landscapes and living beings originating in physical and chemical conditions of different celestial bodies about which information is provided by modern astronomy, astrophysics, and astrochemistry.

Since many fiction writers, while setting out their notion of flight in a fascinating manner, failed to provide drawings and sketches, we have attempted, on the basis of their descriptions, to supply sketches and illustrations which in our opinion help the reader to understand the ideas referred to.

In another book, * an account was given of the very first ideas of man since earliest times as to how to reach the heavenly bodies. These ideas were naive, many even absurd from a modern standpoint, but they were born of the contemporary relationship between man and nature.



* N. A. Rynin. *Mezhplanetnye soobshcheniya. Mechty, legendy i pervye fantazii*, Vol. I, No. 1 (Interplanetary Flight and Communication. Dreams, Legends, and Early Fantasies). — Izdatel'stvo "P. P. Soikin." Leningrad 1928. [English translation by Israel Program for Scientific Translations, Jerusalem 1970. NASA TT F-640, TT 70-50111.]

Chapter I

FROM A GUN TO THE PLANETS

"The gentle luminary of the night appears to be the first station on the journey to eternity."

C. Flammarion

The idea of transporting the heroes of a novel in an apparatus flung from the Earth by some kind of missile device was proposed by several writers, Jules Verne, Le Faure and Graffigny, Wells, Żulawsky, and others, whereby different authors used different throwing instruments, such as a gun or a volcano, or even designed a special enormous hurling machine.

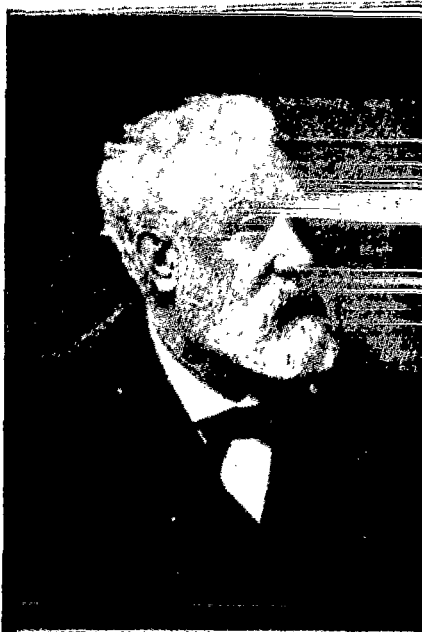

FIGURE 2. Jules Verne (1828–1905)

We shall now give a description of these schemes, accompanied by a criticism of the main ideas inherent in each one. The idea itself was expounded most graphically by Jules Verne.

JULES VERNE

Jules Verne was born on February 8, 1828 at Nantes, the only son of rather affluent parents. He received his secondary education in his hometown. In 1847 he moved to Paris, where he studied law until 1852; he completed the studies but never became a lawyer. He made his literary debut with stories, comedies and poems but in the space of ten years wrote nothing outstanding. During this period he made several journeys to North America, Norway, and the Mediterranean area; later he was to draw extensively on his impressions. At the time that the new type of novel he had created brought him literally worldwide recognition, his social life became singularly uneventful. At first he lived almost uninterruptedly in Paris, and only occasionally in summer made brief excursions to the coasts of France. In 1890 he moved to Amiens, where he lived quietly and peacefully until his death (March 24, 1905), publishing approximately two novels a year. He used the idea of a flight from Earth into space in the following novels: "De la terre à la lune," "Autour de la lune," "Gens dessus-dessous," "500 millions de la Bégum," and "Hector Servadac."

We shall now give an account of the ideas of Jules Verne concerning flight to the Moon by means of a shot from a gun.

VERNE'S GUN NO. 1

In his novel "500 millions de la Bégum", Jules Verne describes a gun from which a projectile is shot which reaches such a speed that it becomes a satellite of the Earth.

This gun (Figure 3) weighed no less than 300 tons and was a kind of siege-gun. It was loaded from the breech and the muzzle was 1.5 m in diameter. The instrument stood on a steel gun carriage placed on a steel platform. Even a small child could fire the gun, for it was so easy to maneuver due to a complex system of gear wheels. In the rear part of the carriage was a compensator, which absorbed the gun's recoil or at least counteracted it and automatically reset it in position after each shot. The force of the blast was so great that from 20 m the missile could easily pierce a meter-thick steel plate as if it were glass. The range of the gun was 16 km. The charge consisted of guncotton with the addition of two-tenths by weight of nitric acid and potash. In addition to this large gun there were other smaller ones. The projectiles of the latter had the shape of tubes, 2 m long and 1.1 m in diameter. They were covered on the outside with a lead casing which traveled freely through the rifling of the gun. At their rear end they had a steel plate with a shaft, and at their front end an arrow-shaped steel point, to which the firing pin of the tube was joined. In spite of their size, their weight did not exceed that of ordinary shells of the same caliber, since they were made of glass and loaded with liquid carbon dioxide at a pressure of 72 atmospheres. On impact, the casing broke and the carbon dioxide changed from the liquid to the gaseous state. As a result, the temperature of the whole surrounding atmosphere fell to 100° below zero, and the air became mixed with a vast quantity of carbon dioxide. Every living thing within a 30-m radius of the explosion

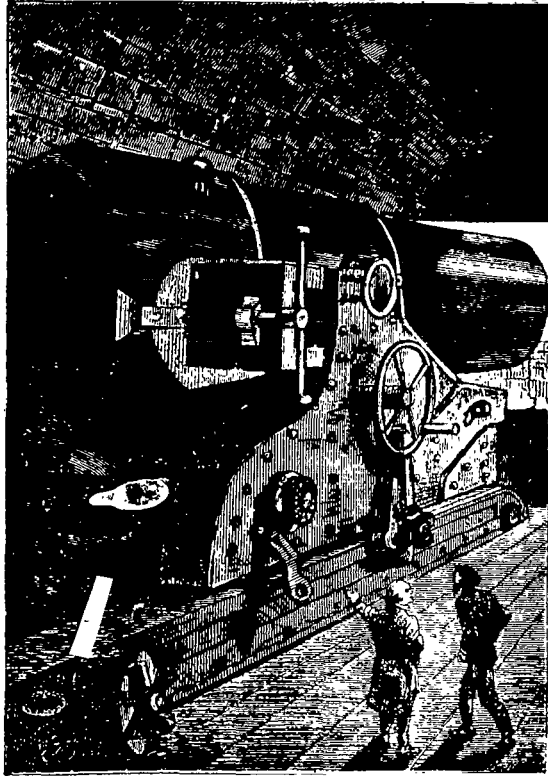

FIGURE 3. Verne's Gun No. 1

died instantly from freezing and asphyxiation. As the described projectile was too light for its volume, the range of its trajectory did not exceed 3 km. For shooting over greater distances from the large gun, projectiles made of cast iron were used; they were solid and each consisted of a hundred small guns symmetrically arranged one inside another like the separate cylinders of a telescope; in flight this projectile divided into guns which, one after another discharged small grenades filled with combustible material. The range of such a projectile was 16 km (Figure 4).

This gun was designed for the destruction of a city. Fortunately a mistake in calculation resulted in the projectile's achieving so great an initial velocity (10,000 m per second) that it did not fall back to Earth but became a satellite.

FROM A GUN TO THE MOON (VERNE'S SCHEME)

In the year 1865 there appeared in France Jules Verne's fascinating novel "De la terre à la lune"; the author describes a gigantic gun cast in America with a projectile in which three passengers ventured to fly to the Moon.



FIGURE 4. Verne's projectile

In another of his novels, "Autour de la lune," Jules Verne speaks of the flight of the projectile in interplanetary space and of the safe return of the travelers to Earth.

We shall give below an account of the principles of construction of the gun and the projectile and the conditions of its flight as depicted by Verne. In a series of notes to this account we add several explanations of our own, and at the end we present a criticism of this project by the German author Max Valier from his book "Der Vorstoss in den Weltenraum" together with several notes by Ya. Perel'man from his book "Mezhplanetnye puteshestviya" (Interplanetary Travel).

VERNE'S SCHEME

The novel begins with a description of the formation in Baltimore, after the end of the American Civil War, of a "Gun Club" in which, in the words of one of its proponents, "The honor and esteem enjoyed by the members of the club is proportional to the mass of weapons they invent and to the square of their range."

Club president Barbican and club member Maston designed a gun which would send a projectile to the Moon. At first a projectile without passengers was proposed but then, at the suggestion of the Frenchman Michel Ardan, a cabin was to be installed in the projectile and it was decided to send President Barbican, Michel Ardan, and Captain Nicholl to the Moon.

The flight velocity of the projectile was to be 12,000 yards (approximately 11,182 m) per second. With this initial velocity the projectile would reach a neutral zone where the gravitational pull of the Earth would be equal to that of the Moon. This point lay 47/52 of the distance from the Earth to the Moon. In Figure 5 the orbits of the Moon and the Earth are shown in orthogonal projections. From the diagram it is clear that the Moon describes an ellipse around the Earth. Its closest point to the Earth (p) is called the perihelion and its farthest point (p₁) the aphelion. At the perihelion the center of the Moon is 363,290 km from the center of the Earth; at the aphelion this distance is 405,400 km. Taking into account the radii of the Earth and the Moon, we find that the shortest distance between their surfaces will be 355,200 km at the perihelion. It would therefore be necessary to fire the gun in such a way that the projectile would reach the Moon as it passed through the perihelion.

In his novel "Autour de la lune" Jules Verne gives the formula by which he determines the flight velocity of the projectile as it leaves the atmosphere:

$$\frac{1}{2} (V^2 - v_0^2) = gr \left\{ \frac{r}{x} - 1 + \frac{m'}{m} \left(\frac{r}{d-x} - \frac{r}{d-r} \right) \right\}$$

V — initial velocity of the projectile

v₀ — its velocity as it leaves the Earth's atmosphere

d — distance between the centers of the Moon and the Earth (according to Verne, 356,720,000 m)

r — radius of the Earth (for Florida 6,370,000 m)

m — Earth's mass $\left\{ \frac{m'}{m} = \frac{1}{81} \right.$

m' — Moon's mass $\left. \right\}$

g — acceleration of the force of gravity on the Earth

x — distance of the projectile from the center of the Earth. For the neutral zone, where the gravitational pull of the Earth and Moon are equal, x = 0.9d

Substituting these values in the formula we obtain v₀ = 11,051 m per second, which corresponds to an initial velocity of 16,576 m per second, apparently acquired by the projectile since, on the one hand, a charge of pyroxylin on firing was taken with a reserve and, on the other, the projectile became lighter in weight (owing to the expulsion of the greater part of the water taken with it).

Duration of the flight was calculated to the neutral zone (at a speed of from 11,182 m per second to zero) as 300,000 seconds (83 hours and 20 minutes), and from the neutral zone to the Moon as 50,000 seconds (13 hours, 53 minutes, and 20 seconds), altogether 97 hours, 13 minutes, and 20 seconds.

When should the explosion be set off? (More precisely, when should the projectile reach the Moon?) At a time when the Moon is not only at the perihelion but also at the zenith in relation to the place of the explosion.

Although the Moon is at the perihelion once a month, it is not always at the zenith. Therefore it is sometimes necessary to wait a long time for a favorable moment. Jules Verne determined this moment as December 4 (the year is not indicated).

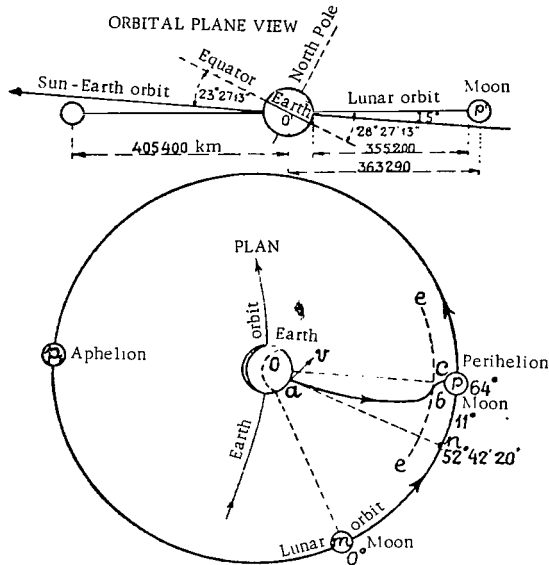

FIGURE 5. Flight of a projectile to the Moon, according to Verne

The gun should be fired to the zenith (Figure 5)*, provided it is located between 0° and 28° latitude, for only there can the Moon be at the zenith and the projectile describe the shortest possible trajectory. If the gun is situated further from the equator the shot must be directed obliquely, which lengthens the trajectory of the projectile. At the moment of firing, the Moon, moving through $13^\circ 10' 35''$ per day, must be at a distance from the zenith corresponding to the path it travels during the flight of the projectile, i. e., $52^\circ 42' 20''$. It is also necessary to take into account the deflection of the projectile due to the rotation of the Earth at the latitude of the gun (velocity v in Figure 5). Therefore the projectile reaches the Moon with an additional deflection of 11° , i. e., with an overall deflection of 64° .

Thus, at the moment of firing the barrel of the gun must be inclined at an angle of 11° to the line of the perihelion, and the charge must be set off when the Moon is at an angle of 64° from the perihelion (then the projectile describes the curve abc (Figure 5), with the point b corresponding to the neutral zone).

The time of blast-off must be on the morning of December 1 at 10 hrs 46 min 40 sec, and the projectile reaches the Moon at midnight of December 4/5.

* The diagram was drawn by us.



FIGURE 6. Maston's first gun

The location of the gun, chosen on the basis of the above-mentioned conditions, was to be in Florida near the city of Tampa, on Stones Hill (27°7' N, 5°7' W).

The gun: weight 68,040 tons, length 274 m, diameter 2.743 m, thickness of the barrel walls 1.829 m. The gun was to be made of gray steel. It was not proposed to rifle the barrel.

The gun carriage gave rise at first to debates in the "Gun Club." Maston proposed to place the gun on the ground, and suggested a length of 800 m (Figure 6). However, the opinion of President Barbican won the day; he produced a plan to construct the gun vertically inside a mountain (Figures 7 and 8). Stonework 5.943 m thick was to be built around the cast-iron barrel of the gun.

The projectile was grenade-shaped, i. e., with the lower part cylindrical and the upper part pointed. Its external diameter was 2.743 m and its height 3.658 m. The other dimensions are given in Figure 9. It should be noticed that there are some variations in the dimensions of the projectile in the account given by Verne. For example, on page 142* it is stated that the internal area of the floor in the projectile was 54 square feet, which gives a diameter of 2.53 m and, correspondingly, a wall thickness of

$$\frac{2.743 - 2.53}{2} = 0.106 \text{ m.}$$

* J. Verne. "De la Terre à la Lune". Hetzel.

However, on page 44 the wall thickness is given as 0.30 m. In order to absorb the force of the blast, water was poured into the base of the projectile to a height of 0.91 m, and on this was placed a thick wooden disk touching the walls; in addition the water was divided by two thinner disks which fractured consecutively at the time of the blast; then the water was directed, through a tube laid inside the walls of the projectile, toward the apex and poured out. After this the disks could be ejected. The walls inside the projectile were slightly thicker than the floor. The projectile weighed approximately 8,000 kg and the water 5,700 kg. The projectile was cast from aluminum. One window was situated at the apex, one in the center of the base, and two in the side walls (in the sequel, "Autour de la lune," it is stated that there were more lateral windows — about four). Entry into the projectile was by means of a hatch near the apex. On the inside the walls were lined with leather attached to springs. A general view of the projectile is given in Figure 10 and an internal view in Figure 11.

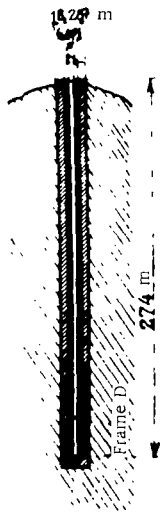

FIGURE 7. Longitudinal section through Verne's gun

Air resistance during the flight of the projectile was considered negligible. Jules Verne writes as follows: "The Earth's atmosphere is only about 65 km thick; thus if the speed of the projectile is 11,182 m per second it passes through this layer in 5 seconds, i. e., in such a short time that the air resistance is negligible."

Explosive material. For the detonation 163,800 kg pyroxylin was used; this was to produce 6,000 million liters of gas when exploded. The charge occupied a height of 54.84 m inside the gun.

Food supply. In addition to the store of provisions taken with them by the travelers, Verne puts forward the idea of sending from the Earth additional missiles containing food. These missiles were to be sent when the Moon was at the perihelion in relation to the Earth, and would be collected by the travelers.

To facilitate the escape of the projectile from the neutral zone between the Moon and the Earth, 12 small steel guns could be inserted into the base of the projectile; the firing of these guns would cause a recoil. Inside the projectile they would be flush with the floor but outside they would project 0.15 cm (Figure 9a).

It should be mentioned that Verne appreciated the possibility of a spaceship changing orbit due to the effect of a passing asteroid and even of fragments striking into the spaceship ("Autour de la lune", page 149).

Result of the expedition. The projectile continued on its way for more than four days. It traveled around the Moon and, by firing rockets, left the neutral zone and began to fall back to the Earth, which it reached on December 12 at 1 a. m., after traveling for 10 days, 2 hours, 13 minutes, and 20 seconds. It plunged into the ocean, then rose to the surface, and all the travelers were rescued by an American corvette (Figure 12).

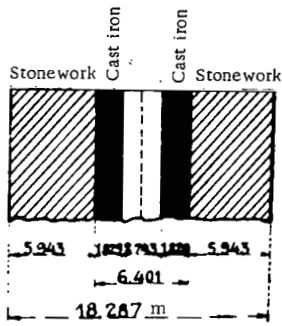

FIGURE 8. Details of Verne's gun

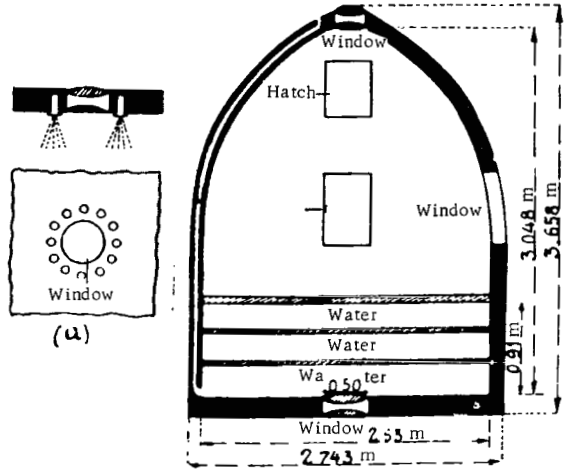

FIGURE 9. Cross section of Verne's projectile



FIGURE 10. External view of Verne's projectile



FIGURE 11. Internal view of Verne's projectile

VERNE'S INTERPLANETARY TRAINS

Jules Verne puts the following words into the mouth of Michel Ardan, one of the heroes of his novel "De la terre à la lune": "I am sure that



FIGURE 12. The projectile falling to Earth

in time actual trains of projectiles with all home comforts will travel from the Earth to the Moon. With this mode of transport there will be no fear of jerkiness nor of running off any rails, and the traveler will reach his destination quickly, without any fatigue, in a straight line resembling, for example, the flight of a bee. . . . " Figure 13 shows such a train of the future consisting of "cars" traveling in space and approaching the Moon.

In his book "Mezhplanetnye puteshestviya" (Interplanetary Travel) (St. Petersburg, ed. 4, pp. 94-103) Ya. Perel'man checked as follows the calculations in Verne's scheme for determining the length of the projectile's flight from the Earth to the neutral zone where the gravitational pull of the Earth equals that of the Moon (Figure 14). This zone lies nine-tenths of the total distance from the center of the Earth. If we suppose that the projectile is at this distance from the Earth and revolves around it like a satellite, knowing that the orbital

period of the Moon is 27.3 days, we deduce the time of orbital revolution of the projectile from Kepler's equation: $\frac{t^2}{27.3^2} = \frac{0.9^3}{1^3}$; thus $t = 23.3$ days, and the projectile travels from the Earth to the neutral zone in $\frac{23.3}{5.6} = 4.1$ days.

In fact the time would be shorter, for the speed would be increased due to the gravity of the Moon, which was not taken into account.

The duration of flight from the neutral zone to the Moon is determined in the following manner.

If the projectile is at one-tenth of the distance from the Moon to the Earth and orbits around the Moon, the orbital period can be determined from Kepler's equation: $\frac{t^2}{27.3^2} = \frac{0.1^3}{1^3}$, thus $t = 0.863$ days, assuming that the mass of the Moon is equal to that of the Earth; but since the mass of the Earth is 81 times greater, and the orbital velocity is proportiona to the square root of the mass, the orbital period will be $\sqrt{81} = 9$ times longer, i. e., $0.863 \times 9 = 7.77$ days; finally, duration of the flight of the projectile from the neutral zone to the moon will be $\frac{7.77}{5.6} = 1.4$ days, though in fact,

owing to the decelerating influence of the Earth, it will be longer (about 2.8 days).

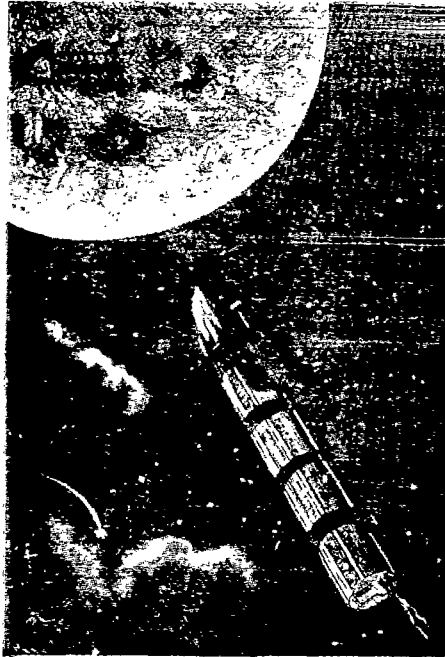

FIGURE 13. Verne's interplanetary train

Total duration of the flight from the Earth to the Moon will be approximately $4.1 + 1.4 = 5.5$ days (in fact, about 6.5 days).

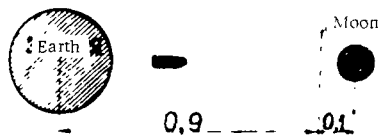

FIGURE 14. A look at Verne's scheme

CRITICISM OF VERNE'S PROJECT (GUN AND PROJECTILE)

The following appear to be the main objections to the feasibility of firing a projectile with passengers from a gun:

1. The impossibility of giving the projectile an initial velocity sufficient for flight into space.
2. The impracticable length of the gun.
3. The certain death of the passengers in the projectile at the moment of firing.

In our further discussion we shall assume that there is no air resistance, for if there were, the problem would become even more difficult.

We shall make calculations for the firing of a 1 kg projectile from a gun to the Moon.

The gravitational work which the charge must overcome equals $0.63 \times 10^7 \text{ kg} \cdot \text{m}$.

The work from 1 kg of gunpowder equals $429 \times 10^3 \text{ kg} \cdot \text{m}$.

Therefore the quantity of charge would have to be

$$\frac{0.63 \times 10^7}{429 \times 10^3} \sim 14.7 \text{ kg}$$

Taking the efficiency of the gunpowder in the gun as one-third of its potential we arrive at a charge of $14.7 \times 3 \sim 45 \text{ kg}$.

The work referred to must communicate to a projectile weighing 1 kg, or of mass 0.1 kg, a velocity v or a kinetic energy

$$\frac{0.1 \times v^2}{2} = 0.63 \times 10^7$$

thus $v = 1.21 \times 10^4 \text{ m/sec}$, i.e., the initial velocity, discounting air resistance, must be approximately 12,100 m/sec, while modern guns give an initial velocity not exceeding 1,500 m/sec.

If we should wish to achieve the required velocity of 12,100 m/sec in 1 sec, then if the weight of the projectile is 1 kg and its mass 0.1 kg, the force would be $0.1 \times 12,100 = 1,210 \text{ kg}$ with the indicated acceleration of $12,100 \text{ m/sec}^2$, which would result in the death of the passengers.

Supposing the pressure on 1 kg not to exceed 1 kg, i. e., the acceleration not exceeding $\frac{1}{0.1} \text{ m/sec}^2$, and supposing the required velocity to be achieved gradually, then it would be possible to arrange along the length of the gun compartments with explosive charges which would be fired consecutively as the projectile passed them.

If we designate the length of time the projectile is in the gun as t , during which it develops a velocity of 12,100 m/sec, then the acceleration will be:

$$\frac{12,100}{t} = 10 \text{ m/sec}^2; \text{ therefore } t = 1,210 \text{ sec}$$

Taking the mean velocity as $\frac{12,100}{2} = 6,050 \text{ m/sec}$, we obtain a gun length of $6,050 \times 1,210 = 7,320 \text{ km}$.

If we accept the acceleration as 50 m/sec^2 , then the gun will be one-fifth as long, i. e., 1,465 km.

Supposing the height h to which the projectile rises to be no more than 300 km, then in the absence of an atmosphere the initial velocity must be $v = \sqrt{2gh} = 2,450 \text{ m/sec}$; if the length of the gun barrel is l , then the acceleration which the projectile must develop is obtained from the formula $v^2 = 2(w-g)l$, therefore $w = \frac{v^2}{2l} + g = \frac{(2,450)^2}{2l} + 9.81$.

Taking the length of the gun as 300 m, we obtain $w = \frac{2,450^2}{2 \times 300} + 9.81 \sim 1,001$, i. e., the weight of the projectile inside the gun becomes nearly 1,000 times greater.

Taking the length of the gun as 210 m and the muzzle velocity as 16,000 m/sec, we can obtain the time spent by the projectile in the barrel of the gun, using the formula:

$$L = \frac{vt^2}{2}; \quad 210 = \frac{16,000t^2}{2}, \text{ therefore } t = \frac{1}{40}$$

and the acceleration $a = \frac{v}{t} = 16,000 \times 40 = 640,000 \text{ m/sec}^2$, i. e., nearly 64,000 times greater than the force of gravity; assuming an acceleration 40 times greater than normal we would obtain an enormous gun length, viz., $v = 11,000 \text{ m/sec}$; $a = 400 \text{ m/sec}^2$.

$$t = \frac{11,000}{400} = 27.5 \text{ sec}; \quad L = \frac{at^2}{2} = \frac{400 \times 27.5^2}{2} \approx 131 \text{ km}.$$

The measures taken, according to Jules Verne, by the passengers in his projectile, such as buffer mattresses and water, are all meaningless in the light of the above-mentioned figures, while the effect of air resistance, which grows in proportion to the square of the velocity, has not been taken into account. This resistance forms a shell which the projectile, at a speed of 11 km/sec, is unable to break. Moreover, flying through the gun barrel — from which it would perhaps be possible to extract the air — the projectile as well as the passengers enclosed in it would undergo a second and no less disastrous shock on entering the atmosphere. It would be possible to lessen the shock by placing the muzzle of the gun high above the surface of the Earth where the atmosphere is much more rarefied. Finally, to avoid the harmful consequences of the impact, it would be possible, as Tsiolkovskii suggests, to place the passengers and delicate instruments in a bath of water equipped with special breathing apparatus for the passengers.

* * *

The German writer Max Valier, in his book "Der Vorstoss in den Weltenraum — eine technische Möglichkeit" (R. Oldenburg, München — Berlin, 1925), analyzes the project of Jules Verne from various points of view. This analysis is presented below.

Calculation of the force of the blast. Taking a gun length of 270 m* (Figure 7) and a charge length of 54 m, we see that when the blast occurs the gases have 216 m in which to expand. If we assume uniform acceleration, then the mean muzzle velocity of the projectile will be $\frac{11,200}{2} = 5,600 \text{ m/sec}$, and the projectile passes through the barrel of the gun in 0.0385 sec or approximately $\frac{1}{26}$ sec. Thus, in $\frac{1}{26}$ sec the projectile obtains an acceleration of 11,200 m and in a whole second 291,200 m. If, in order to obtain a velocity of 11,200 m/sec, for each kg during the projectile's passage through the barrel the energy required is 6.378 million kg/m, then for a 10 ton projectile the energy required is 10,000 times greater, i. e., 63.78 billion kg/m in $\frac{1}{26}$ sec. If the area of the projectile's

* Valier uses round figures which do not exactly correspond to those of Verne's project.

base is $57,256 \text{ cm}^2$, the consumption of energy per cm^2 is $1,113,900 \text{ kg/m}$, which for a distance of 216 m gives a pressure per cm of $\frac{1,113,900}{216} = 5,157 \text{ kg/cm}^2 = 5,157 \text{ atmospheres}$. *

The air resistance, negligible according to Verne, in fact proves to be enormous. The following distinction may be made: a) air resistance inside the bore of the gun, and b) air resistance outside it.

The air resistance inside the bore occurs over a distance of 216 m on an area of $57,256 \text{ cm}^2$, which gives a volume for the [air] column of $1,237 \text{ m}^3$ and a weight of $1,237 \times 1.2 = 1,500 \text{ kg}$, i. e., about $1/6$ of the weight of the projectile. As the projectile leaves the muzzle it must eject all this air from the gun with the same velocity, but this would require the expenditure of additional energy equal to about $1/6$ of that expended for the ejection of the projectile. Moreover, the air will be compressed, which requires still more energy, equal to about $14,000$ million kg/m . It may happen that, due to the air resistance in the bore, the energy of the gases reaches a maximum velocity not when the projectile reaches the end of the barrel but earlier; thus the maximum velocity of the projectile occurs somewhere inside the barrel and the muzzle velocity will be much less.

In order to counteract this destructive effect, Valier proposes to pump out all the air from the barrel and then to close it with a cover which the projectile would easily pierce.

External air resistance at ground level at a projectile velocity of $11,200 \text{ m}$ would be about $1,000 \text{ kg/cm}^2$, which represents a counter-pressure of $1,000$ atmospheres. In order to achieve parabolic velocity, in the first second after leaving the gun the projectile must travel $12,000 \text{ m}$, requiring an energy expenditure (taking mean air resistance as 491.6 kg/cm^2) of $491.6 \times 12,000 = 5,900,000 \text{ kg/m}$ per cm^2 .

The energy expended on the resistance of the whole atmosphere is $7,600,000 \text{ kg/m}$ per cm^2 . Thus, the energy expended to overcome the air resistance is greater than that required to overcome the Earth's gravity (6.378 million kg/m).

We shall now compare the kinetic energy of the projectile per cm^2 of its base with the impeding external air resistance.

• If the weight of the projectile is $10,000 \text{ kg}$ and the area of its base $57,256 \text{ cm}^2$, the weight per cm^2 will be $175 \text{ g} = 0.175 \text{ kg}$. With a velocity of $11,200 \text{ m/sec}$ and an energy expenditure of 6.378 million kg/m per kg of the projectile's weight, we obtain an energy expenditure per cm^2 of $6.378 \times 0.175 = 1.114$ million kg/m , while that required to overcome the air resistance is 7.6 million kg/m ; in other words, when the projectile leaves the bore of the gun it is stopped by the air.

Thus it would be better, as suggested by one of the heroes of Verne's novel, to construct the projectile not of aluminum but of cast iron, i. e., heavier, but then the gun would have to be longer and the charge different.

Moreover, it would be necessary to make the projectile narrower and longer, which would decrease the air resistance per cm^2 of its base. If the projectile's shell were made of tungsten-hardened steel and filled with lead, the weight per cm^2 still would be only 5 kg . In modern hand grenades the length is $5-6$ times greater than the width. The aluminum

* According to Verne, the area of the base is $50,167 \text{ cm}^2$. Valier generally makes extremely approximate calculations.

projectile devised by Verne, even if it could have left the muzzle of the gun, would have been crushed into a pancake by the air resistance.

VALIER'S GUN

Max Valier, in examining the project of Jules Verne, gives a plan of his own dealing with the basic elements in the construction of a gun and a projectile to be sent into interplanetary space.

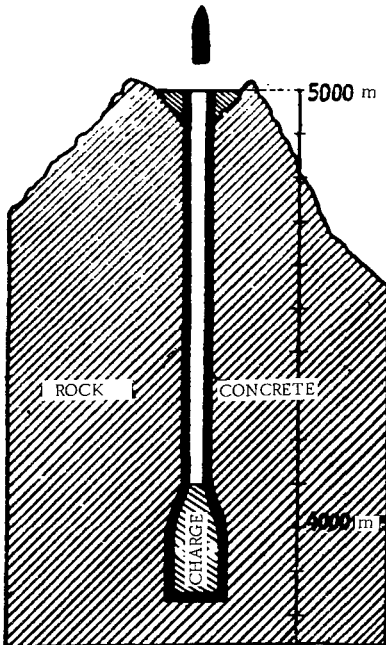

FIGURE 15. Valier's gun

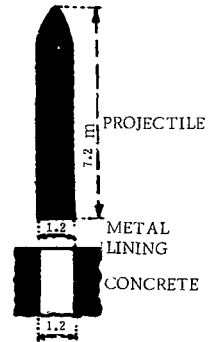

FIGURE 16.
Valier's projectile and the muzzle of his gun

1. The **projectile** must have a diameter of 1.2 m, a length of 7.2 m, and a specific gravity of 13.9 (the shell is made of tungsten-hardened steel and filled with lead). In this case the load per cm^2 of the transverse section will be 10 kg.
2. The **gun** must have a barrel 900 m long and be placed in rock with the muzzle 5,000 m above sea level. It must be sited somewhere near the equator. The barrel must be made of concrete, with a layer of rifled metal on the inside. Before firing, all the air is extracted from the bore.
3. The **initial velocity** of the projectile must be 12,000 m/sec. Moreover, for each kg of its weight it will have a kinetic energy of 7.34 million kg/m, keeping in reserve, apart from the power consumed in overcoming the Earth's gravity (6.378 million kg/m), a further 0.966 million kg/m per kg, or 9.66 million kg/m per cm^2 , which is quite sufficient to pierce the shell

of air resistance. At the speed mentioned, the projectile passes through the barrel in 3.75 sec. Figure 15 shows a vertical section through the rock and the gun, according to Valier's project, and Figure 16 shows the muzzle of the gun and the projectile.

LE FAURE AND GRAFFIGNY'S GUN

The two French authors J. Le Faure and de Graffigny describe, in their fantastic novel "Aventures Extraordinaires d'un Savant Russe" (Paris, 1899), how two scientists were sent to the Moon in a projectile dispatched by a powerful blast from a gun constructed vertically in the ground.

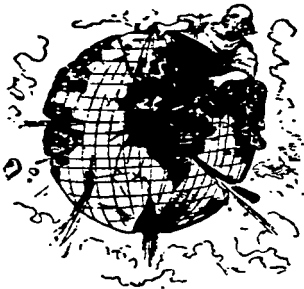

FIGURE 17. The Earth exploding, according to Le Faure and Graffigny

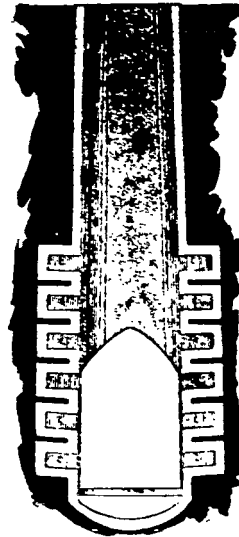

FIGURE 18. The gun of Le Faure and Graffigny

The principle. The explosive used was a supposedly newly discovered substance called selenite, the explosion of 1 g of which would generate 10 m^3 of gas and impart to a 100 g platinum bullet a speed of 2,000 m per sec and a range of 16 km. Several tons of this substance could cause the whole Earth to explode (Figure 17). This substance was composed of nitrogelatin and potassium carbonate.

Construction of the gun. In order to overcome the force of gravity more quickly, the gun must be fired vertically, and in the first second the projectile must attain a velocity exceeding 11,300 m/sec. For the projectile to reach such a velocity it is necessary to give a series of extra impulses in the form of successive explosions at various places in the barrel of the gun during the passage of the projectile through the gun. The projectile is

3.50 m high and 2 m in diameter. The gun, which is made of steel, is 80 m long and weighs 600 tons. It is cast in the ground (Figure 18). Inside the bore there are 12 explosion chambers with 15-cm-thick walls. In each of these is placed 500 kg of selenite; at the base of the bore is a charge of 1,000 kg. A space of 50 cm is left between the charge and the base of the projectile. All the explosion chambers are connected to electrical ignition devices, which, after the explosion of the lowest charge, touch off successively the explosion of the lateral charges as the projectile passes them and impart to the projectile a velocity of 12 km/sec.

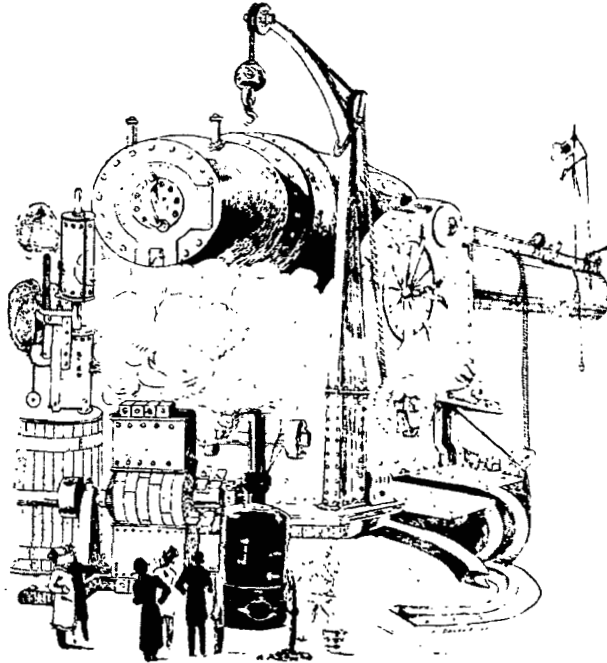

FIGURE 19. Second gun of Le Faure and Graffigny

The firing site was selected in the Southern Hemisphere, on Malpelo Island belonging to Colombia.

When the firing takes place the projectile is sent to the Moon and the passengers survive the shock. When the projectile lands on the Moon the springs and mattresses prove capable of absorbing the force of the impact and again the passengers survive. Apart from the gun described above, the authors provide an illustration of another gun of an ordinary type but with enormous dimensions; this too would be used to send a projectile to the Moon (Figure 19).

FROM A VOLCANO TO THE MOON (ACCORDING TO
LE FAURE AND GRAFFIGNY)

In the same novel these two authors present a description of the flight of five men to the Moon in a projectile which was embedded in the crater of the Cotopaxi volcano in America and hurled into interplanetary space by a powerful eruption.

Construction of the projectile. A general view of the projectile is given in Figure 20 and a longitudinal section in Figure 21. The projectile was made of nickel magnesium, which weighs half as much as aluminum and is very strong. The whole projectile, weighing 600 kg, was composed of separate parts, which facilitated transportation. The details of construction are as follows (Figure 21). A — laboratory furnace, B — electric battery, C — beds rolled and suspended from the walls, D — chemical preparations, E — oxygen cylinders, F — crates containing provisions, etc., L — electric light, L — closet, M — library, N — chest of drawers, toilet, and closet, R — compressed air (caisson), T — sofa with rolled up mattresses, V — windows (6).

The electric battery, used for illumination, was sufficient to work for 240 hours.

Heating was provided by burning spirit.

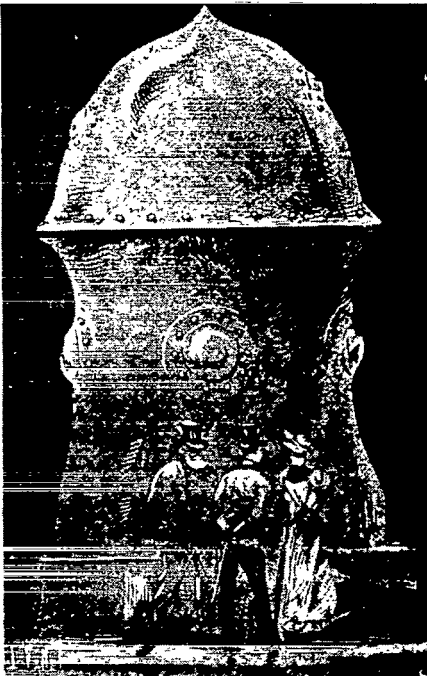

FIGURE 20. Flight from a volcano to the moon, according to Le Faure and Graffigny. Projectile — general view

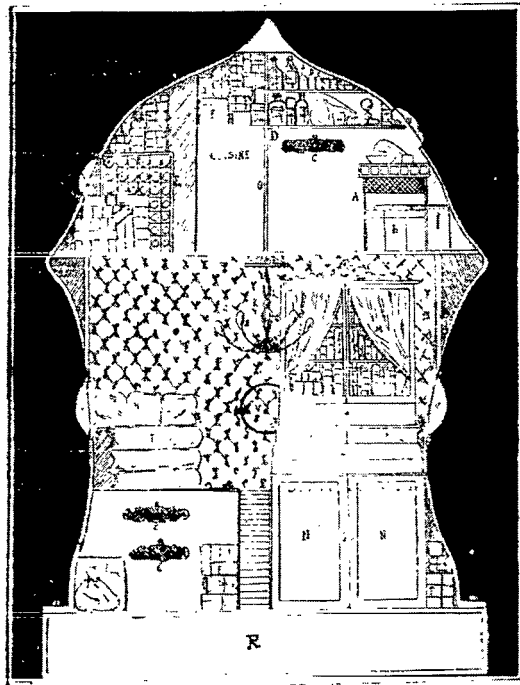

FIGURE 21. The projectile of Le Faure and Graffigny — vertical section

Oxygen, condensed into a solid state in the form of tablets, was used for renewal of the air. Potassium hydroxide was used to absorb CO_2 from spent air.

The crater of the volcano. According to the authors quoted, the speeds of the gases erupted by volcanoes are as follows: Etna — 800 m/sec, Vesuvius — 1,250 m/sec, Hekla — 1,500 m/sec, Stromboli — 1,600 m/sec, Pichincha, Cotopaxi, and Antisana 3—4 km/sec. For the purpose of the journey the Cotopaxi volcano was chosen (Figure 22). In its crater was a vertical channel 300 m deep ending in a layer of obsidian. The walls of the channel, 10 m in diameter, were smoothed by means of machines and the projectile was inserted at the base. Since the projectile was somewhat narrower, a second caisson of compressed air, 10 m in diameter, was placed between the projectile and the base of the channel, completely stopping up the channel. The thrust of the erupting gases could then shoot the projectile like a bullet, and the air which on compression leaves the second caisson through special valves could soften the force of the shock. The initial velocity of the projectile was to be 11,000 m/sec.

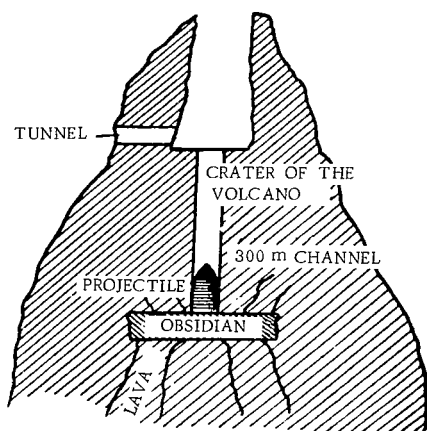

FIGURE 22. Section of the Cotopaxi volcano



FIGURE 23. Flight from a volcano to the Moon

The departure from the Earth. When all the preparations were completed and the Earth and Moon were in favorable relative positions (March 25, at 6.10 in the evening), the passengers took their places inside the projectile. The proximity of the eruption had already been forecast by sensitive seismographs, but it was artificially accelerated by exploding the obsidian slab underneath the projectile. By this time all the passengers were rolled up in mattresses. When the pilot pressed the button there was a tremendous jolt and they all lost consciousness. Meanwhile the projectile, under the pressure of several million cubic meters of subterranean gases, disappeared upward, passing through the Earth's atmosphere in less than 5 seconds (Figure 23).

Later all the travelers regained consciousness and satisfactorily completed the flight from the Earth to the Moon.

The landing on the Moon took place in the following manner. Although the speed of descent was 2,500 m/sec, owing to the rarefied nature of the lunar atmosphere the projectile did not become incandescent from friction on passing through it, while in the bottom of the projectile there were powerful

springs which lessened the force of impact. Before the moment of impact the travelers rolled themselves up in the mattresses. Finally, a terrific jolt shook the whole projectile; the chandelier and the lamps were shattered into thousands of fragments, pieces of furniture were torn from their places and thrown into one great pile. Everyone lost consciousness . . . but regained it after a while. Nobody was injured.

FROM MARS TO THE EARTH (ACCORDING TO WELLS)

The English novelist H.G. Wells in his book "War of the Worlds" describes the arrival of inhabitants of Mars on the Earth (in England), the extermination by them of people and their destruction of buildings, and finally the death of the invaders due to microbes. For their flight they set off detonations which propelled projectiles containing Martians from Mars to the Earth. Here is how Wells describes the flight and the construction of the projectile.

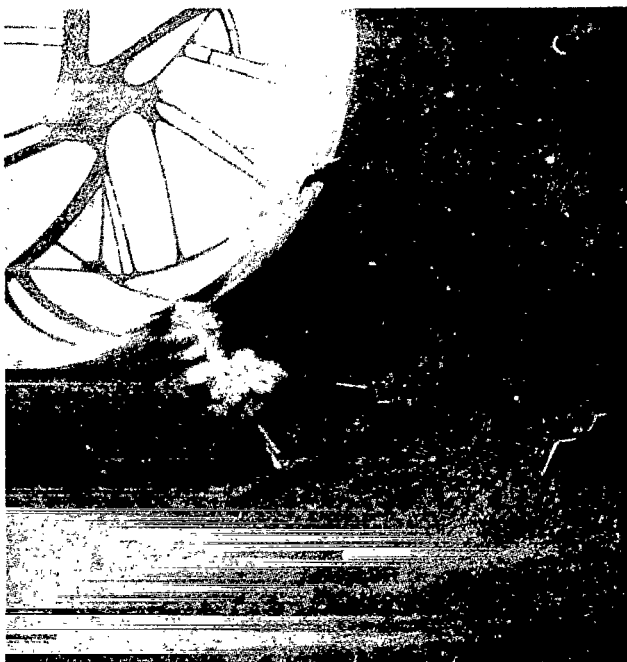

FIGURE 24. An explosion on Mars

The departure from Mars. At about midnight on August 12, when Mars was in opposition to the Earth, i. e., at the shortest distance from it, astronomers noticed a stream of incandescent gases issuing from the planet Mars (Figure 24); a spectroscope indicated that the stream consisted of almost pure hydrogen and was moving at tremendous speed in the direction of the Earth (Figure 25). After a quarter of an hour the streams disappeared, so that it might actually be assumed that a colossal gun had

been fired. Other similar emissions took place and were seen from the Earth for ten consecutive nights, always exactly at midnight.

The arrival on the Earth. One fine morning, soon after daybreak, there appeared in the sky a fiery streak, approaching rapidly. People took it for an ordinary meteorite. Its flight was accompanied by a strong whistling sound. Many people witnessed the descent of the meteorite. Soon it was found, having made a deep crater in the ground (Figure 26) and thrown up great mounds of sand and gravel which formed a high embankment around the crater. In addition it set fire to heather in the surrounding wasteland.

The projectile. The "meteorite" mentioned above proved to be a cylindrical projectile about 27 m in diameter; it was densely covered with a deposit which had formed during the flight through the atmosphere. When the cylinder had become somewhat cooler, the upper part began to rotate slowly on its axis. The shining yellowish-white surface of the screw resembled none of the metals known on Earth (Figure 27).

Conclusion. Wells gives no further details concerning the sending of the projectile from Mars to the Earth, nor concerning the projectile's orientation in space, nor concerning the measures taken by the Martians, who reached the Earth safely, to protect themselves from the harmful effects of the explosion.

FLIGHT FROM MARS TO THE EARTH IN A PROJECTILE FROM A GUN, ACCORDING TO RADLEY

The English fiction writer F. A. Radley in his book "The Green Machine" describes the flight from Mars to the Earth by means of a shot from a gun of a Martian together with an Earth-dweller who had flown to Mars.



The Martians constructed an enormous gun which shot passenger-carrying projectiles into space.

The gun shot into space an aerolite, to which was attached a special "green machine" with which the Earth-dweller had flown to Mars and which the travelers needed for their landing on Earth.

The departure from Mars took place on the day of a solar eclipse. The aerolite was shot in such a way that it flew round the solar system and reached the Earth in two years and ten days. During the flight it touched the orbits of all the large planets of the solar system, traveling a total of 5,500,000 miles. Not far from Neptune the aerolite met Halley's comet, which carried it along in the direction of Earth.

On leaving Mars the two travelers took their places in the green machine, which was attached to the aerolite and enveloped in an airtight and sound-proof covering. They also wore suits made from the same material.

When the desired moment arrived the shot was fired and the aerolite together with the machine flew out of the gun into space at a speed of many thousand miles per second. An automatic instrument recorded the time and also the distance between the aerolite and the Sun.



FIGURE 26. The Martians' landing on Earth

The itinerary planned was as follows: the planet Ceres, Jupiter, Saturn, Uranus, Neptune, Halley's comet, and then turning with the latter towards the Sun, Mercury, Venus, and the Earth.



FIGURE 27. The Martian projectile

After meeting the comet the travelers released themselves from the aerolite, which was then carried away into space, and continued in the green machine, no longer carried off by the comet.

When the machine entered the Earth's atmosphere the flight velocity decreased, but the projectile fell into the sea; the travelers fell out of the machine and, swimming to the surface, found safety on a small island. The machine was lost in the water. Later the Martian fell victim to an octopus, but the Earth-dweller was rescued by a steamboat. The story ends with the death of the traveler in a hospital.

IN A PROJECTILE FROM A GUN TO THE MOON
(ACCORDING TO ŽULAWSKY)

In 1911 a translation appeared in Moscow of the Polish novel by G. Żulawsky "In the Silver Sphere." In this book the author describes the fantastic flight of two passenger-carrying projectiles from the Earth to the Moon and the sending of a letter from the Moon to the Earth. The author gives very few details concerning construction of the projectiles and the flight. He refers to the scheme of Jules Verne, which was realized 100 years after the death of the celebrated novelist.

The launching site for the projectile was on the coast of Africa, some twenty kilometers from the mouth of the Congo. Five passengers took their places in the projectile, which was placed in a pit of cast steel. Under the influence of the force of the explosion occurring in a perpendicular direction, the Earth's gravity, and the acceleration imparted by the daily rotation of the Earth on its axis, the projectile described a vast parabola in space in a west-east direction and, entering at a certain point and at a certain time into the Moon's gravitational field, it fell nearly perpendicularly into the center of the Moon's disk facing the Earth, in the region of Sinus Medii. According to the author's account, the travelers survived the blast and flew to the Moon. They took with them wireless telegraph equipment which operated over a distance of 260,000 km.

Six months later another similar two-man expedition was dispatched from the Earth. A radio message was received from the travelers just before the landing on the Moon, which proved disastrous for them, for they fell not perpendicularly but obliquely and so were crushed to death. The first expedition reached its goal, but some of the participants were killed and the remainder were unable to return. Upon arrival on the Moon they converted their projectile into a hermetically sealed wagon, propelled by means of a special electric motor.

Beginning their account of the flight, one of the participants in the expedition writes:

"On the Moon Date.

"Good Lord! What date must I put here? The tremendous explosion which we let hurl us away from Earth has destroyed for us what is considered to be the most reliable thing in the Universe — time itself. In fact it is terrifying to think that where we are there are no years, no months, none of our fine, short terrestrial days. . . ."

As for technical details of construction of the gun and the projectile, the flight, and the landing on the Moon — the author's imagination is pitifully weak and he brings no new ideas.

ŽULAWSKY'S INTERPLANETARY FLYING GUN

G. Żulawsky in his novel "The Victor" describes how a man traveled from the Earth to the Moon using as a flying machine a projectile enclosed in a steel cannon which, as it fell, loaded itself by means of compressed air. It fell with its base toward the Moon, pointing in the direction of the Earth.

For the return flight all that was necessary was to enter the projectile, shut oneself in and press a button, and the projectile would fly out

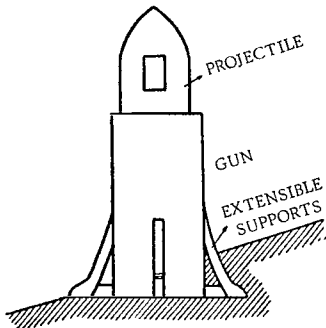

FIGURE 28. Żulawsky's flying gun

of the gun (Figure 28). Żulawsky further describes how, unknown to the man in "The Victor" who had flown from the Earth, two inhabitants of the Moon, descendants of human beings who had gone to the Moon several centuries earlier, decided to seize the machine.

"They approached the enormous steel cylinder deeply embedded in the ground. Protruding from it was the conical tip of the projectile, from which a ladder descended. By means of this they reached the mouth of the iron cylinder and the projectile which lay inside it. After long and fruitless efforts they finally managed to open the door and go inside. A metal ladder extended from there to the very base of the projectile.

As they descended, the door slammed shut on them, and at the same moment an electric light was lit automatically by the closing of the door.

Soon they found a button in the form of a small ball of bone in a metal mounting set in the wall with a glass cover. One of them broke the glass and pressed the ball into the metal ring.

A slight vibration shook the floor of the projectile

After a long search they found on the floor a metal panel covering a thick glass window. There, beneath their feet, they saw the Moon rushing away at a terrifying speed; they were hurtling further and further away from it into space

. . . . All that was left on the Moon were the outer shell of the projectile and the remains of the mutilated bodies of those Moon inhabitants who had helped the two travelers enter the projectile."

THE OPINIONS OF TSIOLKOVSKII AND DE STEFANO CONCERNING GUNS

As early as 1895 K. Tsiolkovskii expressed the opinion that if a gun **several kilometers long** were constructed and placed horizontally, it might be possible to shoot from it a projectile containing a man immersed in liquid and send it into space.

On the other hand, in the opinion of the Italian general Antonio de Stefano, in order to impart a velocity of 11,100 m/sec to a projectile 150 mm in diameter, the gun would not need to be more than about 800 m long.

AN AMERICAN GUN

In 1924 an American project was published for sending a passenger-carrying projectile into space by means of a gun. The gun was 5.5 km

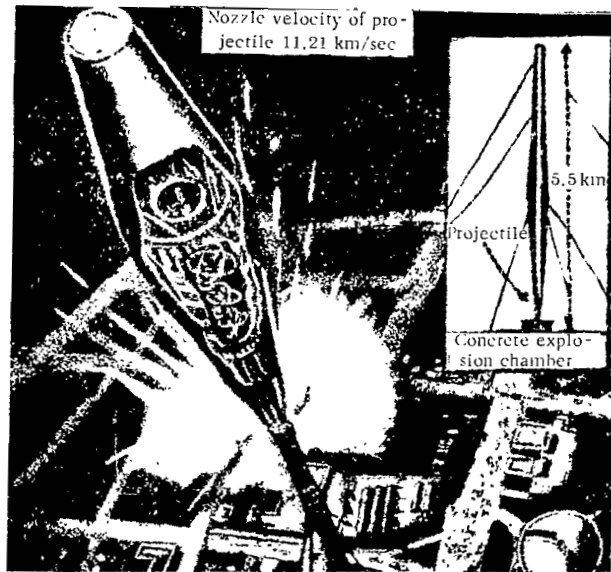

FIGURE 29. Project for sending a projectile to the Moon



FIGURE 30. The projectile of the American gun

long and mounted vertically. At the bottom were a concrete explosion chamber and the projectile. On leaving the gun the projectile would gain a velocity of 11.2 km/sec. Inside the projectile there had to be devices for protecting the passengers from the shock (Figure 29).

Figure 30 shows separately the construction of the projectile. The following parts can be seen, beginning from the nose: springs and hydraulic

cylinders (1), a recoil mechanism (2), circular windows made of thick glass (7), the crew seated in armchairs made on the gyroscopic principle (3), auxiliary springs to absorb the shock (4), rollers and springs to withstand the lateral shock if the projectile were to leave the Earth at an angle (8), windows in the outer shell (9), a hydraulic valve (10), a disk which the trolley containing the passengers will reach after one hour (5), water, supports (11), hydraulic cylinders to absorb the shock (12), an armored disk 60 cm thick (13), supports (6).

A HUMAN PROJECTILE

In the Leningrad State Circus in the year 1927 a demonstration took place of the flight of an Italian, Ugo Zaccini, from an air gun. Compressed air caused a piston to eject the flier from the gun. The flier executed a parabola in the air and fell into a net. The height of the ascent was about 6 m, the acceleration on takeoff about 2 g, the distance of flight about 10 m and the time of flight about $1\frac{1}{2}$ sec.

It is reported in a book that in Germany, Leinert flew from a similar gun to a height of about 25 m.

SHOOTING FUNGI

A common phenomenon among the fungi is that the spores (i. e., the seeds) are "fired" from the parent plant; when the spores mature, the organ holding them bursts and the spores are scattered in all directions in a fine spray.

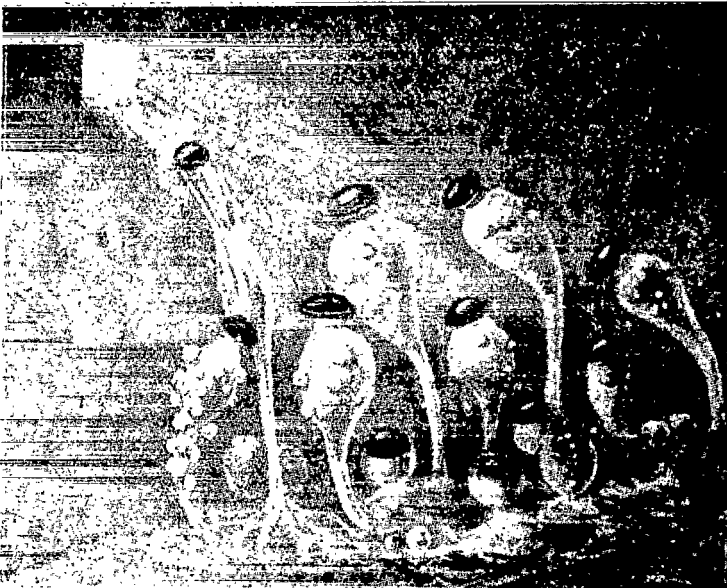

FIGURE 31. Fungi shooting spores toward the Sun

But some fungi display not simply a scattering of the spores but a "shooting" of them in a particular direction, namely in the direction of a bright light.

This peculiar "firing at a visible target" is clearly observed in the small fungus *Pilobolus cristallinus* which grows in manure (Figure 31). If some manured soil containing mycelia of this fungus is placed in a cardboard box with a small glass window, when the fruiting bodies of the fungus develop they will stretch out clearly in the direction of the window. When the spores mature, they will be "fired" by the fungus straight at the glass window. It is easy to judge the accuracy of this peculiar target practice from the faint sound of the spores striking the glass. The accuracy depends simply on the fact that the fruiting body of the fungus bends its stalk under the influence of light, so that the tip of the sporangium will be turned directly toward the window. The force of the burst is determined by the pressure of the juices in the green fungus. This throwing force, though practically negligible, is quite substantial in relation to the size of the fungus.

Chapter II

HURLING MACHINES

"The invention of a projectile by means of which one could reach the moon should not seem to us any more improbable than the invention of a ship would have seemed in olden times, and there is no reason to abandon hope of success in this matter" ("A Discourse Concerning a New World and Another Planet," in two books, by Wilkins. London. 1640).

HURLING BY MEANS OF ROTARY MOTION

By hurling we mean a method of imparting speed to a body by means of mechanical action and machines, such as springs and levers. As we have already seen, in order to throw a body at what is called parabolic velocity, which would enable it to leave the Earth, various forces and therefore various speeds would be required on various planets. For example, while the parabolic velocity for the Earth is 11,180 m/sec, that for the asteroid Pallas is only 424, and that for Atalanta no more than 27 m/sec, i. e., one 500th part of that for the Earth; that of Phobos is only 12 m/sec, i. e., only one thousandth part of the parabolic velocity on the Earth. Thus only an insignificant force would be required, for example, to propel a ball from the planet into space.

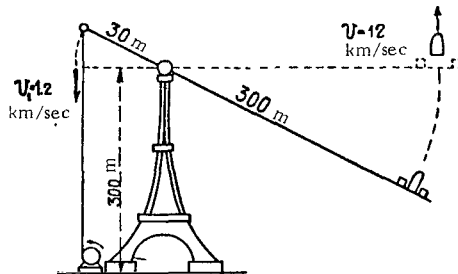

FIGURE 32. A machine for hurling a projectile to the Moon

Theoretically speaking, to impart a speed of 12 km/sec to a projectile leaving the Earth, a tower 300 m high could be built and a swiveling lever attached at the top of it, with one arm of the lever 300 m long and the other, for example, 30 m (Figure 32). Forcing the left-hand end to move at a speed of 1.2 km/sec, we would then impart to the right-hand end a speed ten times greater, viz., 12 km/sec. However, since to construct such a gigantic catapult would be impractical and even impossible, we must look for other means of throwing projectiles into space.

THE MASSE-DROUET AND GRAFFIGNY HURLING MACHINE

Several plans for hurling a projectile into interplanetary space were proposed by the French scientists and fiction writers Le Faure and Graffigny.

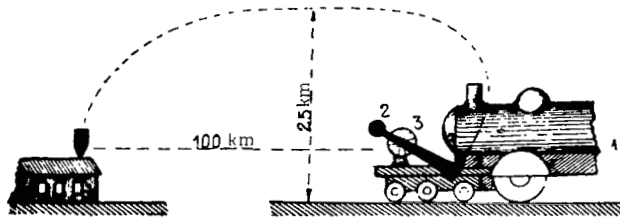

FIGURE 33. A small catapult devised by Graffigny

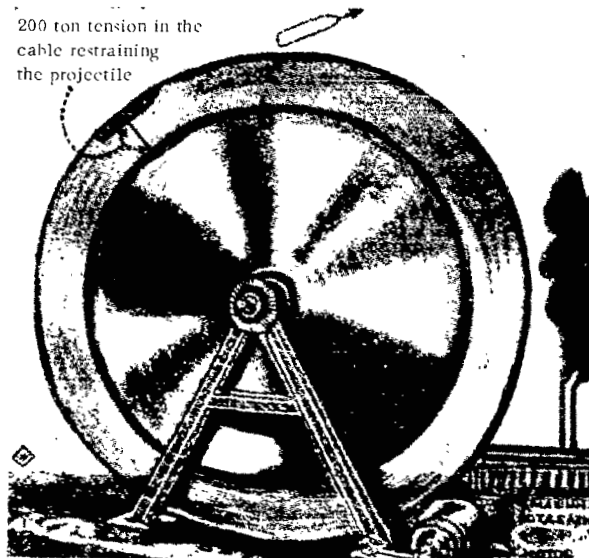

FIGURE 34. Graffigny's centrifugal hurling machine

In 1913 the two French engineers Masse and Drouet reiterated the idea of Le Faure and Graffigny and further proposed the idea of constructing a machine consisting of a wheel of enormous diameter, with a passenger-carrying projectile attached at its circumference. The wheel would

perform 40–50 revolutions per second, and when the projectile reached a speed of 12,500 m/sec, it would separate from the wheel and soar into space.

In 1915 Graffigny proposed the construction of a special machine for hurling projectiles to a height of 25 km and a distance of 100 km (Figure 33). This necessitated a speed of 1.5 km/sec and a 1,000 horse-power turbine engine. The device consisted of a steam locomotive which rotated the shaft of a centrifugal machine with a turbine (3). Mounted on the shaft was a beam with a counterweight (2) and a sling (1) in which was placed the 100 kg projectile. At the required moment an electrical device was operated and the projectile ejected.

In the same year Graffigny proposed a new variant of the idea of hurling an entire spaceship, which would derive its initial velocity from the rotation of a huge wheel, at the circumference of which the spaceship would be attached (Figure 34).

When the speed of rotation of the wheel was sufficient the projectile, under the influence of the enormous centrifugal force, would be released and hurtle off tangentially at the same speed as that of the corresponding point on the wheel. This hurling machine would be sited somewhere above a crevasse, for example, among rocks in the mountains. It would be set in motion by a steam turbine and, at the right moment, with the aid of an electrical device, the spaceship attached to the wheel would be released and would fly vertically toward the zenith many thousands of kilometers above the surface of the Earth.

GRAFFIGNY'S INTERPLANETARY SHELL

In 1916 Graffigny proposed the following new project for a flight into space by means of centrifugal force.

Concept of the flight.

The projectile or shell is placed at the end of a beam mounted on an axle. At the other end of the axle is a counterweight. If the beam is 50 m long (Figure 35) and the number of revolutions 44 per second, then the end of the beam develops a speed of $2\pi R \times 44 = 2 \times 3.14 \times 50 \times 44 = \sim 14$ km/sec, which is sufficient for the shell on its release to fly into interplanetary space. To increase the rotation of the beam to such a speed in the space of 7 hours, a motor would be sufficient whose power

$$M = \frac{14,000 \times 1,620}{4,600 \times 75 \times 7} = 12,000 \text{ hp.}$$

FIGURE 35. Graffigny's large catapult

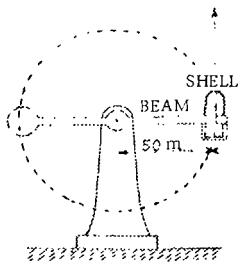

At the required moment an electrical device would operate to release the projectile, which would fly tangentially into space. The shell itself

must have an internal motor to enable it to change direction and speed. This might be a special rocket motor.

Figure 36 shows a section and a plan view of the shell.

Its height is 11 m and the diameter 4.2 m. Its outer casing is made of 8 vertical frames connected by rings. The casing is covered outside and inside with aluminum sheeting.

The shell has 5 stories:

I. Storeroom containing: water tank, barrels, canned food, chemicals, and inside the walls liquefied air containers;

II. Laboratory containing motors, an electric heater, accumulators for lighting, a door for entering and leaving the shell;

III. Dining room: sideboard, table, lamp, sofa, two windows;

IV. Cabins and lavatory;

V. Observatory with astronomical instruments; above this is a rotating dome with 3 windows. Rotation of the dome takes place in an annular groove filled with liquid helium which does not freeze down to -273° .

Ladders provide communication between the stories. The weight of the projectile when empty is 1,250 kg, interior fittings and equipment 750 kg, and two months' provisions for 3 passengers 2,000 kg; thus the overall weight is 4,000 kg.

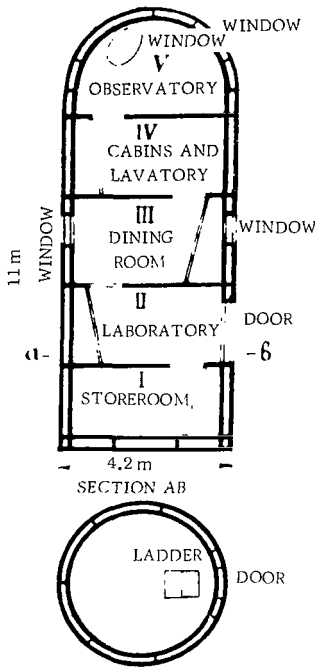

FIGURE 36. Graffigny's interplanetary shell

A. PLATONOV'S LUNAR BOMB

The idea of projecting a spaceship to the Moon by means of rotary motion found expression in A. Platonov's story "Lunnaya Bomba" ["The Lunar Bomb"], "Vsemirnyi Sledopyt,"

No. 12, 1926. The theme of the tale is as follows. The engineer Kreuzkopf proposed to the government of a certain republic to send to the Moon a "lunar bomb" — a spherical projectile. The latter, with its useful load and the inventor himself, would be attached at the periphery of the disk which is placed on the Earth. The disk may be set up at any angle to the horizon, depending in which direction the projectile is to be sent.

The disk is given the required number of revolutions and at the prearranged moment the projectile is released and flies off at a tangent to the disk.

The safe descent of the projectile to the Earth or to another planet is provided for by means of automatic devices in the projectile: when the latter approaches a planet the current is switched on in the automatic device and an explosive charge is detonated. The reaction of the burning gases slows down the flight and the projectile descends safely.

As a first experiment Kreuzkopf proposed to send a projectile in such a way that it would describe a curve around the Moon and return to Earth. In the opinion of the inventor, the cost of construction would be 600,000 rubles.

The invention was accepted, the money paid, and the equipment constructed. The inventor and recording instruments were placed inside the projectile and the departure was to take place at midnight on March 19/20. Here is how the moment of departure is described. "At three minutes to midnight the disk was rotated. The electric motor roared; giant ventilators drove great clouds of cold air through the motor; the oil in the equipment was cooled by icy currents and yet acrid smoke surrounded the whole structure. The disk roared like a cannonade... Its periphery was smoking – it was burning from friction with the air, the number of revolutions reached 946,000 per minute. *"

At the required moment the bomb separated from the disk and flew away. About 15,000 of the spectators were deafened and about 10,000 experienced nervous shock.

There followed communications sent by the inventor from the bomb to the Earth by radio. Finally these communications cease, and, for some unknown reason, the bomb falls onto the Moon. . .



Illustrations by the artist S. Lodygin

FIGURE 37. Platonov's bomb approaching the Moon [The Russian lettering is the title of the story, "Lunnaya bomba."]

Figure 38 shows the rotating disk at the moment when the bomb flies away from it, and Figure 37 shows the bomb flying toward the Moon.

ELIMINATION OF THE FORCE OF GRAVITY

Note. When bodies are rotated, centrifugal force develops. Thus at the equator, bodies lose $1/289$ of their weight. If the Earth rotated 17 times faster, bodies at the equator would become weightless, for their weight would be counterbalanced by the centrifugal force which would have increased by $17^2 = 289$ times.

* Here the author makes a mistake in his calculations, for with this number of revolutions and with the speed of 12 km/sec the radius of the disk would be only 12 cm.

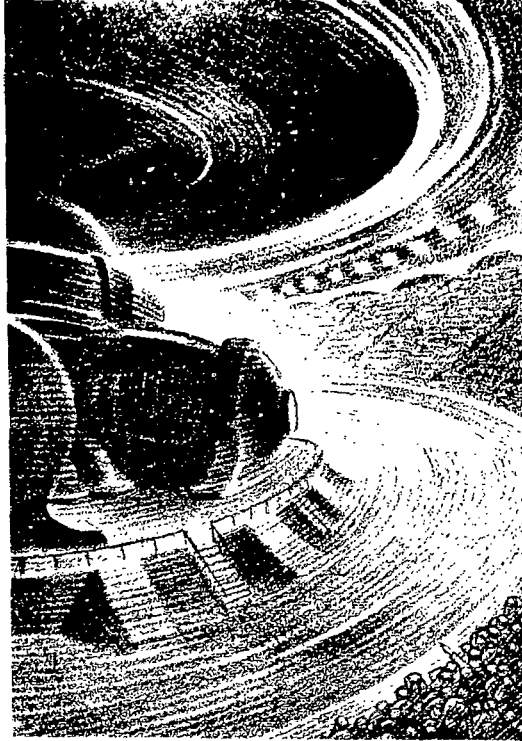

FIGURE 38. Platonov's disk for hurling the bomb to the Moon

A FRENCH PROJECT FOR HURLING A PROJECTILE TO THE MOON

In 1927 there appeared in France a new project for hurling a projectile to the Moon, also based on the principle of centrifugal force. In place of the rotating wheel, a circular tunnel was to be constructed 20 km in diameter, with a railroad track laid inside it. On the rails ran a truck (1) (Figure 39) with specially designed skates (2) instead of wheels. Oil from the oil tank (3), forced by compressed air from the reservoirs (4) passes through the tube (5) and enters between the skates and the rails, reducing friction by 90%; movement of the truck is carried out by means of the fixed stator (6), laid inside the rails throughout their length, and by the moving rotor (7) attached below the chassis of the truck; (8) is the base of the projectile and (9) are the buffers. The air inside the tunnel is very rarefied, in order to reduce resistance to the moving projectile; if the tunnel is 20 km in diameter, the centrifugal force is $1/400$ of that of a rotating wheel 1 km in diameter and, in the opinion of the author of the project, constitutes no danger either to the projectile or to people inside it. At a certain point the tunnel has an additional branch (1) (Figure 40) which forms a tangent to the circle and is inclined upward at the correct angle; when the projectile has reached the

required speed, the track is switched to the branch line, at the end of which the truck remains where it is while the projectile flies out at a speed of 12.5 km/sec; at the moment of leaving the Earth's atmosphere this decreases to 10.9 km/sec. In Figure 40 the numbers represent: 2 — vacuum pump, 3 — oil injector, 4 — switch, 5 — rails, 6 — projectile.

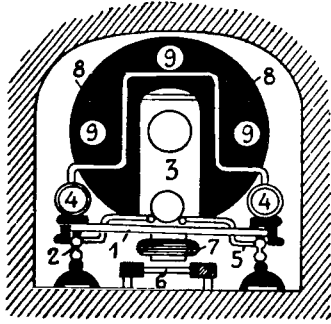

FIGURE 39. The French interplanetary projectile in the tunnel

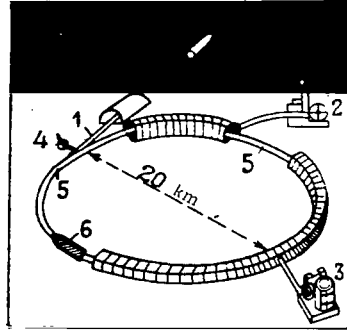

FIGURE 40. Circular tunnel for accelerating the projectile

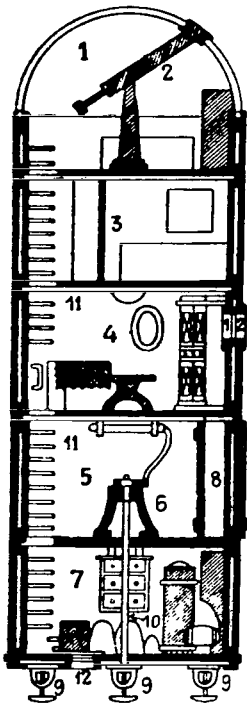

FIGURE 41. Longitudinal section of the interplanetary projectile.

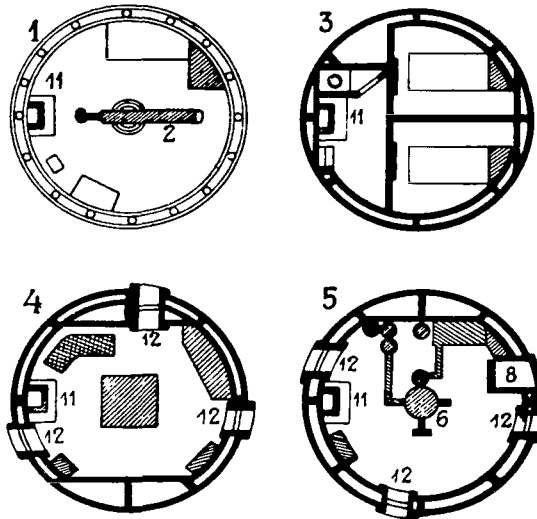

FIGURE 42. Cross section of the interplanetary projectile

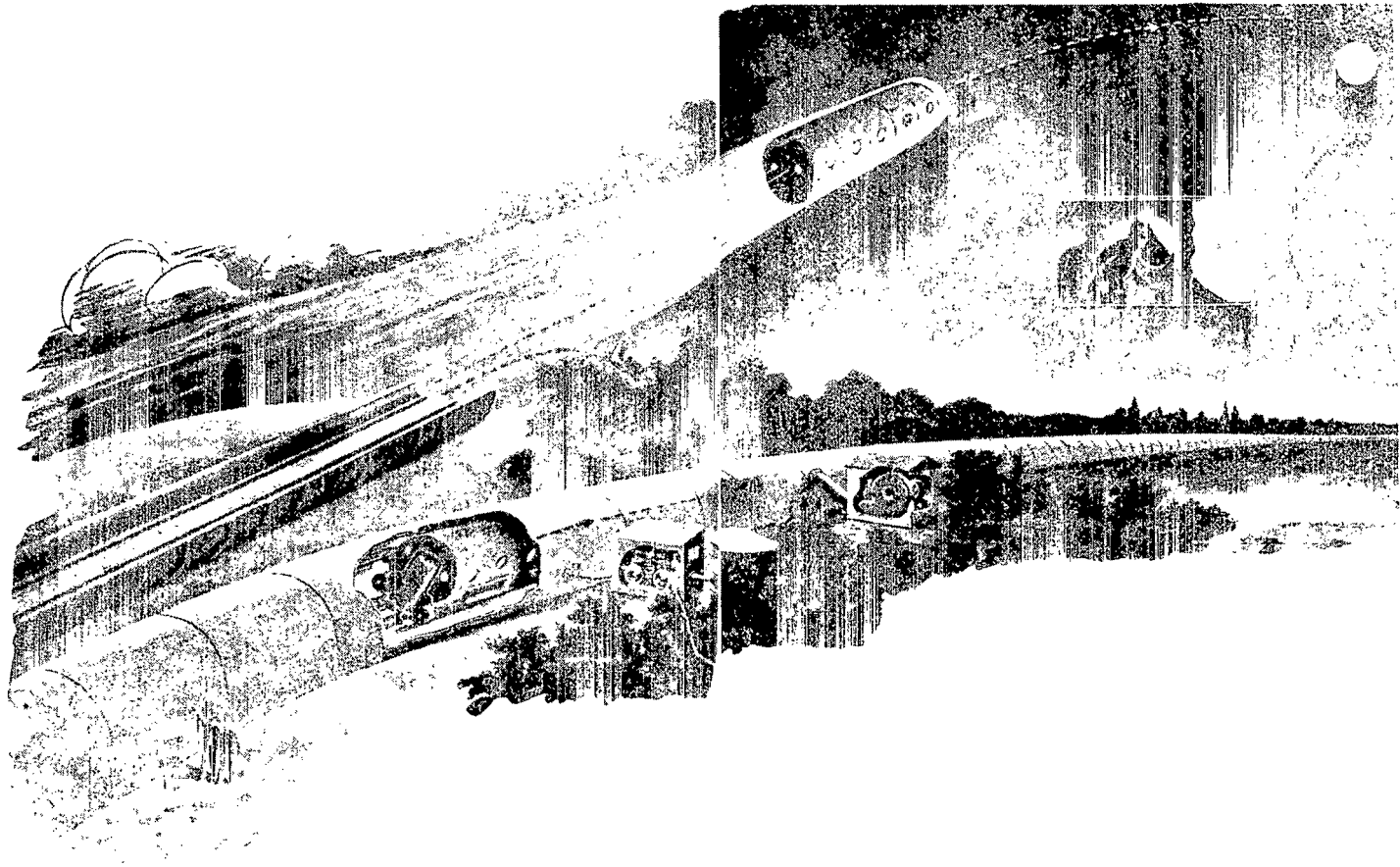

FIGURE 43. General view of the circular tunnel and the projectile

The continued motion of the projectile in space is caused by inertia; the motion is controlled by changing the direction of emission of explosive gases (jet or rocket propulsion); regulation of the blast, i.e., changing its strength and direction, can increase or decrease the flight velocity of the projectile and alter the direction of flight.

Thus the projectile, thrown out beyond the Earth's gravitational field, flies into space in the direction of the Moon, gradually losing speed; after 83 hours of flight the projectile enters the gravitational field of the Moon; by firing explosives, the travelers cause the rocket to describe a smooth curve around the Moon and then fly back to the Earth; the entire journey to the Moon and back lasts about 7 days. A safe landing on Earth is ensured by a huge parachute and by retrograde firing of explosives which decrease the speed of fall.

The projectile used for this flight to the Moon is illustrated in longitudinal and cross sections in Figures 41 and 42. The nose contains a small observatory (1) with a telescope (2); from this observatory the observers can examine the lunar surface at close range and take photographs of it; 3 and 4 — crew's quarters, designed for 3 persons; 5 — jet engine compartment; 6 — laboratory; 7 — storeroom for various items and materials and for liquid oxygen; 8 — exit hatch; 9 — buffers; 10 — one of the outlet pipes for explosive gases; 11 — ladder for communication between all five compartments of the projectile; 12 — skylights. The walls of the projectile are double, made of a special alloy of steel and aluminum; the walls are double in order to maintain a constant temperature inside the projectile in spite of the sharp temperature changes which take place outside.

Figure 43 shows the general setup.

Chapter III

FLIGHTS WITH THE AID OF MINUS AND PLUS MATTER

Man fell with apples and with apples rose.
If this be true, for we must deem the mode
In which Sir Isaac Newton could disclose
Through the then unpaved stars the turnpike road,
A thing to counterbalance human woes;
For ever since immortal man hath glowed
With all kinds of mechanics, and full soon,
Steam-engines will conduct him to the Moon.

Byron. "Don Juan"

In this chapter we examine interplanetary flight projects proposed by various fiction writers and based on the idea of nullifying the Earth's gravity by means of a special substance which either does not transmit the force of gravity into the projectile — such a substance we call minus matter — or else makes the projectile transparent to the rays of gravitation which are no longer capable of affecting the object — such a substance we call plus matter.

There have been many projects based on the principle of minus and plus matter. We shall describe those of A. Dumas, Bogdanov, Wells, Sahulka and Lasswitz, Service, Faizandier, and Mukhanov. The question has been dealt with critically by Ya. Perel'man in his first edition of "Mezhplanetnye puteshestviya" ["Interplanetary Travel"], which we also cite below.*

DUMAS' MENTION

In 1865 a book by Alexandre Dumas appeared in Paris entitled "A Journey to the Moon," in which the author describes the flight of his heroes to the Moon with the aid of a substance which "is repelled by the Earth."

A. BOGDANOV'S AIRSHIP AND ETHER-SHIP

The author A. Bogdanov in his book "Krasnaya zvezda" ["Red Star"] (a Utopian novel, 1908) describes two flying machines: one for flying within the Earth's atmosphere which we shall call a "terrestrial airship" and the other for flight between the Earth and Mars, which we shall call an "ether-ship."**

- * We mention here the attempt of P. A. Orlovskii to explain the origin of the force of gravity by the influence of ether waves which, on meeting a physical object which lies in their path, produce a "gravitational" effect upon it.
- ** It should be mentioned that as early as 1908 Bogdanov's project keenly interested the late L. M. Matsievich, who tried to clarify the construction of a machine in which men would fly to Mars (see "Sbornik pamyati L.M. Matsievicha" [The L.M. Matsievich Memorial Volume], p.17, St. Petersburg, 1912).

In both machines the principle of leaving the ground and being supported in the air was the same, namely by means of so-called "minus matter"; horizontal movement was achieved differently in the two machines: in the terrestrial airship by means of an electric motor which rotated a three-bladed propeller, and in the ether-ship by means of a reaction engine as in a rocket.

Here is how Bogdanov describes the construction and essential features of the "minus matter":

"The electrical theory of matter, which necessarily represents the force of gravity as some kind of derivative from the electrical forces of attraction and repulsion, should lead to the discovery of gravity with the opposite sign, i. e., to the discovery of a type of matter which is not attracted but repelled by the Earth, the Sun, and the other known planets. This phenomenon may be compared to diamagnetic repulsion of bodies and to repulsion of parallel currents of opposite directions.

"Intensive study of the radioactive elements and their decay and an analysis of the structure of matter has led to the discovery of elements which are repelled by terrestrial bodies, to the determination of means of preserving them and preventing their escape from the solar system; then with their aid a synthesis of "minus matter" was carried out. In outward appearance it resembles mercury. Each flying machine contains a tank filled with a sufficient quantity of this matter "of a negative type." Then all that remains is to impart a forward motion to this already "weightless system" by means of an electric motor with an air propeller or by means of a reaction engine in an airless space."

We now proceed to a description of the flying machines.

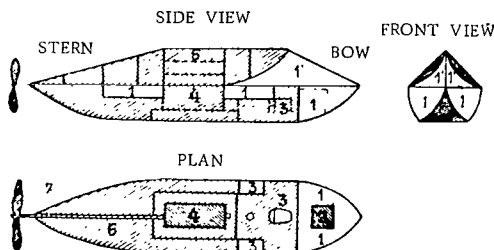

FIGURE 44. Bogdanov's terrestrial airship

The terrestrial airship (Figure 44) takes the form of a small ship for the transportation of 2—3 persons. It is made of metal and glass. In its forward part the side and bottom (1,1) are of glass 2 cm thick with steel bars. Above the bow sides, two flat crystal plates (1', 1'), connected at an acute angle, cut the air and protect the passengers from the rapid motion. The middle part of the ship is occupied by an electric motor (4) which via the shaft (6) drives the three-bladed propeller (7). The forward part of the ship and the motor are covered above by thin sheeting attached to the metal-work of the glass sides and to light steel columns. On Earth the airship requires ballast. The minus matter is placed in a cylinder (5). The pilot sits in an armchair (3), with benches (3) at the side for passengers. The flying speed of the machine is 240 km per hour.

A. BOGDANOV'S ETHER-SHIP

In his above-mentioned book "Red Star" Bogdanov describes the construction and flight of a special machine from the Earth to Mars. From Bogdanov's description we have produced an illustration of this "ether-ship" (Figure 45).

Its construction and method of flight are as follows.

Principle of flight. In the upper compartment are placed cylinders containing "minus matter," which neutralizes the Earth's gravitational force, so that the whole machine can balance in the air without support. The ether-ship is driven by reaction from detonations of a special substance. Here is how Bogdanov describes the effect of this force:

"The driving force of the ether-ship is one of the radioactive substances which we can obtain in large quantities. We have found a method of accelerating the disintegration of its elements hundreds of thousands of times; this is performed in our motors with the aid of quite simple electrochemical processes. A vast amount of energy is released by such a method. The particles of the disintegrating atoms separate at a speed tens of thousands of times greater than that of artillery shells. If these particles can fly away from the ether-ship only in one predetermined direction, viz., in a single channel with walls which they cannot penetrate, then the whole ether-ship moves in the opposite direction as from the kick of a rifle or the recoil of an artillery gun. From the law of kinetic energy it is possible to calculate what an insignificant fraction of a milligram of such particles is required per second to impart uniformly accelerated motion to the ether-ship."

CONSTRUCTION OF THE ETHER-SHIP

External shape. The ether-ship is almost a sphere with a flattened segment at the base. This shape is designed to obtain a maximal volume for a minimal surface area, i. e., the smallest outlay of materials and the smallest cooling surface.

The first (lowest) story is partitioned into 5 rooms, one central and four lateral. In the middle of the central room rises the engine (2), around which on all four sides circular glass windows (3, 4, 5, 6) are set in the floor; of these one is of pure crystal, the other three of glass of various colors; the walls are 3 cm thick.

The fundamental part of the engine consists of a vertical metal cylinder (1) 3 m high and 1.5 m in diameter and is made of osmium, a metal with a very high melting point related to platinum. The disintegration of the radioactive matter takes place in this cylinder; the red-hot 20-cm-thick walls testify to the energy of this process. In order that the heat should not be too great in the compartment, the whole cylinder is surrounded by a casing (2) twice as wide as the cylinder and made of a special transparent substance which gives excellent protection from heat. The top of this casing is connected to pipes (13, in the vertical section illustration) through which heated air flows from the casing in all directions to ensure even heating of the ether-ship.

The remaining parts of the engine, connected by various means with the cylinder — electric coils (9), accumulators (10), indicators with dials (8) —

are arranged round about in orderly fashion. Because of a system of mirrors (12), the engineer on duty can see everything at once without moving (11).

One of the lateral rooms is the "astronomical" room (4), to the right and left are the "water" (5) and "oxygen" rooms (3), and at the opposite side is the "computing" room (2).

In the "astronomical room" the floor and outer wall are made entirely of crystal — polished glass of highest purity. At the sides are placed instruments (19) mounted on complex supports descending from the ceiling and interior walls of the room. The main telescope (18) is about 2 m long but with a disproportionately large objective and with a diamond eyepiece.

In the computing room (2) stand machines (15) with a multitude of dials and indicators. Prominent among these is the largest (14), from which extends a long tape with the results of the calculations.

The oxygen room (3) contains the stores of oxygen in the form of 25 tons of Berthollet's salt (17, 17), from which up to 10,000 m³ of oxygen could be generated as required. This amount is sufficient for several journeys from the Earth to Mars. The same room contains the apparatus for decomposing the Berthollet's salt (16, 16). Here too are kept the stores of baryta (16₁) and caustic potash (16₂) for the absorption of carbon dioxide from the air, and also reserves of sulfuric anhydride for the absorption of excess moisture and volatile leucomaine — a physiological poison which is released by exhaling and which is incomparably more harmful than carbon dioxide.

In the water room (5) is an enormous water tank (20) and large devices (21) for purifying water. Numerous pipes (22) carry this water from the tank to all parts of the ether-ship.

Second story (II). An elevator (10) connects the stories.

This story contains a central hall (6) and laboratories: photographic room (7), chemical room (8), and also two rooms for various purposes (13, 14), bathroom (9), gymnasium (10), library (11), and lounge (12).

Third story (III). This story contains a hangar (15) for the airship (23), sacks of ballast (24) for the airship and columns for mooring it. In addition there are the crew's cabins (16, 17, 18, 27)* and the cabins of the passengers.

Fourth story (IV). The central room (28) is occupied by a second (upper) observatory, exactly similar to the lower one but with a crystal covering above only and with large instruments (25, 26). The six** lateral divisions of the upper segment, forming a ring around the observatory, are completely without windows. Their ceiling, which forms part of the surface of the sphere, slopes diagonally down to the floor. Against the ceiling are placed large containers of minus matter, the repulsive force of which would neutralize the weight of the whole ether-ship.

The main materials used in construction of the ether-ship are aluminum and glass.

The flight of the ether-ship. The departure from Earth. The departure from Earth was silent, gradual, scarcely noticeable. The speed was 2 cm per second, which rose after one minute to walking speed and after 15 minutes to the speed of an express train. The slow rotation of the ether-ship

* According to A. Bogdanov, the cabins open onto a long corridor. We considered a radial distribution more practical, each room having access to a central room (15).

** For design reasons we have decided on eight rather than six.

BOGDANOV'S ETHER-SHIP

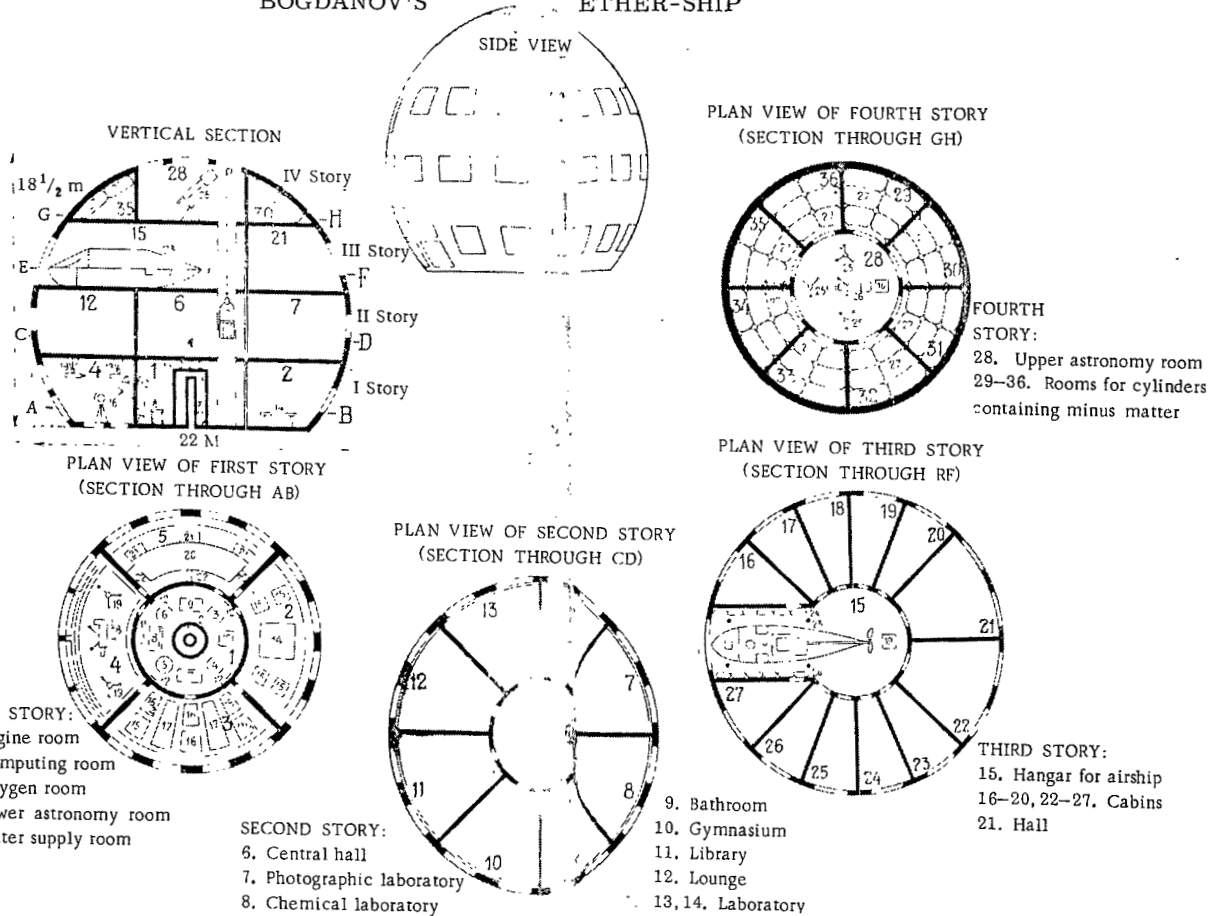

FIGURE 45. Bogdanov's ether-ship

on its vertical axis permitted all-round observation. The maximum speed of the ether-ship was 50 km per second but the average speed 25 km per second.

The liquids were kept sealed so that they should not be spilled or assume a spheroidal shape. The furniture and crockery were fastened in their places. Everwhere handles and straps were attached to prevent unintentional rapid movement when the force of gravity was considerably reduced.

On leaving the Earth the machine, due to inertia, maintained its speed of movement around the Sun, viz., 30 km per second, while the speed of Mars around the sun was 24 km per second; if the machine flew perpendicularly to its orbit, then it would strike the surface of Mars with a residual lateral velocity of 6 km per second. To avoid this the machine must fly in a curved path of about 160 million km in 2.5 months. During the flight, in the course of one chemical experiment, an explosion took place in the laboratory, making a hole in the wall of the ether-ship. The Martian Letti closed the gap with his own body, and the air pressure burst his lungs and paralyzed his heart.

* * *

Leaving aside criticism of the principle proposed by Bogdanov, based on support of the ether-ship by means of imaginary minus matter, we shall mention here the following (in our opinion) positive aspects of the project:

1) the spherical shape of the ether-ship, resembling that of the celestial bodies;

2) the reaction engine on the first story; cooling of this motor is foreseen;

3) mechanical calculation of details of the flight which, in view of the tremendous speed of flight, is very important;

4) cautious increase of speed of flight.

Finally, one finds here — which is not the case with many other novels — a well thought out constructive treatment of the spaceship and a more technical approach to an imaginative fable.

However, it may be thought that this technical basis for a novel was probably influenced by the ideas of the French engineer Esnault-Pelterie who had earlier put forward the idea of using for the space flight a reaction engine driven by the products of radium disintegration, and at the same time advised slowly increasing the flight speed, so that there would be no great acceleration harmful to the human organism. The latter circumstance is usually given little consideration by fiction writers, although it has a very important role both in aviation and in future space flights.

THE ONTËITE SPACESHIP OF ITIN

The idea of using minus matter for space flight was applied in the novel of Vivian Itin "Vysokii Put'" ["The High Path"] (Moscow, 1927).

Here is how the author describes his spaceship.



FIGURE 46. H.G. Wells

The scientist Ontè presented a complete theory of gravity and discovered a special complex of the energy of matter, ontèite, which is repelled by mass. Airships were constructed in the form of graceful dolphin-shaped objects. Their shells were cast from light metals, and in the upper central part were placed ontèite surfaces, locked in the diaphragm of an isolator of the kind used in cameras. Movement of the diaphragm provided the necessary vertical acceleration.

Released from gravity, "the conquerors of space" floated to the limits of gravity, and then a small radioactive engine was sufficient for them to develop planetary speed and to fly in any direction. Constant communication existed with the various planets.

In the airless medium the sole unexpected danger was from meteorites, stray fragments of other worlds; but accurate instruments recorded their approach, making it possible to avoid collision with these peculiar reefs of interplanetary space.

WELLS' GRAVITY SCREEN

Principle of flight. In his novel "The First Men in the Moon" (1901) the renowned English novelist H.G. Wells describes the flight of two men from England (Lympe) to the Moon, and then the return of one of them to Earth.

The hero of the novel, Cavor, tries to find a substance which would be impervious to all forms of radiant energy. Radiant energy — light, heat, X-rays, the electrical waves of wireless telegraph, gravity — all these emanate from a center as radiation and act in space on other bodies, hence the name "radiant energy." Nearly every body is impermeable to some kind of radiant energy and permeable to other kinds. All bodies, however, are prone to attraction, i. e., to the force of gravity. Light rays can be denied access to an object by means of obstacles; with the aid of metal plates an object can be protected from electrical waves. No obstacles, however, can protect an object from the attraction of the Sun, nor from the force of gravity of the Earth. The hero finds a means of artificially creating such a substance — proof against attraction — from an alloy of several metals and the newly discovered element helium.

When the first sheet of the unknown substance was prepared and cooled to 16°, the column of air and part of the roof and ceiling above

it lost their weight; there was a kind of explosion, and everything lying on the plate as well as the substance itself was carried into space.



FIGURE 47. Cavor's machine

The machine. Here is how Cavor describes the construction of the machine:

"Imagine a spherical projectile spacious enough to hold two men and their luggage. The projectile will have two shells, the inner of thick glass, the outer of steel. The travelers can take with them a store of compressed air, concentrated food, apparatus for the distillation of water, for the absorption of carbon dioxide, etc. The inner glass shell will be continuous except for the hatch; the remainder consists of separate parts, each of which can be moved aside like a shutter. This is easily arranged by means of special springs: the shutters can be lowered or rolled up by an electric switch leading along a platinum wire and a glass casing. The outer shell of the projectile will consist of windows and of cavorite shutters.

"When these shutters are pulled down tightly, neither light, heat, the force of gravity, nor any kind of radiant energy can penetrate the sphere. The latter will be carried through space 'in a straight line. However, if one of the shutters is raised, then any heavy object which happens to pass outside opposite the window will attract the projectile, and

thus we will be able to travel in whatever direction we wish, attracted by one or another of the celestial bodies."

Figures 47 and 48 show an exterior view of the machine and Figure 49 an interior view.

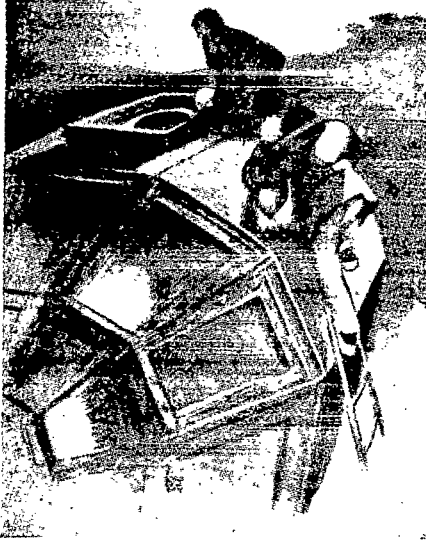

FIGURE 48. Cavorite machine, according to Wells. Exterior view



FIGURE 49. Interior view of Wells' machine

The departure from the Earth. When the machine and its equipment were ready, Cavor and his companion took their places inside it. Here is how Cavor's companion describes the moment of departure:

"Suddenly I felt a slight jolt and heard a noise like the uncorking of a champagne bottle nearby, and then a faint whistling sound. For a moment I felt a terrible strain, as if my legs were being pressed downward by a force of innumerable tons. Then this feeling passed and we, like all objects inside the projectile, could float freely in the air! The machine left the Earth and was carried into space toward the Moon."

Ya. I. Perel'man, in his comments on this novel, calculated that Cavor's projectile would fly the distance from the Earth to the Moon in $1\frac{1}{2}$ months.

The descent to the Moon. "Suddenly Cavor opened a shutter opposite the Moon and we saw that we were falling in the direction of a large circular lunar mountain surrounded by numerous small craters. Then Cavor turned our projectile once again in the direction of the scorching, dazzling Sun. Apparently he was using the Sun as a kind of brake to lessen the speed of our fall. Then he continued to manipulate the shutters and quickly opened them all, one by one. We experienced a heavy jolt and began to roll about inside the projectile, thrown now against the glass, now against a package,

with all our belongings colliding with one another. Our projectile was rolling along a snow-covered slope. Finally there was a crash and then peace and quiet reigned. We had both survived and reached the Moon. "

The return flight. Cavor remained on the Moon. His companion took off from the Moon in the machine as already described and was carried to the Earth. This journey, under the influence of the Earth's gravity, lasted about five days (according to Perel'man). As it approached Earth, the machine began to fly almost parallel to the Earth's surface when it reached the upper layers of the atmosphere. The pilot opened all the shutters of the machine which continued its fall, passing from the zone of polar day into the glow of twilight and from twilight into the polar night; then he closed all the shutters except one and slowed down the headlong speed of the fall. The machine fell into the sea. The last window was closed. The machine struck the water with a splash and dived deep below the surface. The pilot closed all the shutters, the descent of the machine was slowed down and it floated to the surface. In the morning it ran into a shoal. The pilot was rescued, but the projectile, owing to careless handling by one of the inquisitive onlookers, was carried back into space. . . .

Conclusion. Wells' idea of using "cavorite" to overcome the force of the Earth's gravity or of any other gravity is contrary to the laws of physics, in particular the law of conservation of energy, for his idea conceives the miraculous possibility of creating energy "out of nothing. "

Ya. PEREL'MAN'S CRITICISM OF WELLS' PROJECT

Wells based his project on the use of a substance he called "cavorite" by which he screened his spaceship from the influence of gravity and which made the ship weightless. However, such a substance has not yet been invented, and if it were, it would be extremely difficult to move it from place to place as Wells proposed. The energy required for such movement would be extremely great, equaling that required to transfer the protective screen from the given point to a point infinitely distant in space where the force of gravity is nil. If the intention is protection from the Earth's gravity, the work involved is called "the gravitational potential at the surface of the terrestrial globe." For example, the work involved for 1 kg is the equivalent of 6,370,000 kg/m and, according to Wells, this work must be performed almost instantaneously. If the weight of two men and the stores carried in the projectile equals about 500 kg, then closing all the screens on the side facing the Earth would consume in one second

$$\frac{6,370,000 \times 500}{75} = 42,460,000 \text{ hp.}$$

Thus the use of gravity screens would involve consumption of an enormous amount of energy, the source of which Wells does not mention.

Finally, the third fault of the project is the slowness of flight of the spaceship, which would travel from the Earth to the Moon only under the influence of the latter's gravity. The flight to the Moon would last nearly 45 days.

THE INTERPLANETARY SHIP OF SAHULKA AND
LASSWITZ
(Screen for neutralizing the pressure of rays of
attraction)

According to the theory of Sahulka, the Earth is subject to the influence of a rain of ether atoms, which continuously fall upon it from all directions out

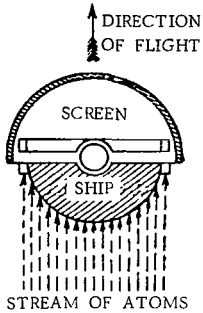

FIGURE 50. Lasswitz's screen

of space and penetrate it in all directions. However, when we examine objects anywhere on the Earth's surface, we find that they are under the influence of a resultant force of atomic pressure directed toward the center of the Earth, because from the direction of space (i. e., from above) there is nothing to weaken the pressure of the atoms, while from the direction of the Earth it will be weakened, for the stream of atoms must pass through the whole thickness of the Earth. On the basis of this idea Lasswitz proposed the following project concerning a ship for space communication (Figure 49): let us imagine a passenger-carrying sphere around which there rotates on its axis a screen or cover in the form of a hemisphere with the property of not being subject to the pressure of atoms. Then, under pressure from the atoms acting on the ship from below, the ship itself will be

borne in the direction of the screen. Rotation of the screen on the axis of the ship can alter the direction of flight.

It is not difficult to show, however, that such a screen cannot exist, for according to the theory of Sahulka himself all terrestrial bodies, and therefore also the substance of which the screen is made, are subject to the pressure of the stream of atoms.

SERVICE'S RAYS (WHICH NEUTRALIZE THE FORCE
OF GRAVITY)

In about the year 1918 Garret P. Service, an American scientist, drew a picture of what would happen if rays were invented and used which would neutralize the force of gravity. (Cited from Ya. Perel'man, "Puteshestvie na planety" ["Travel to the Planets"], second edition, 1919, p. 16).

"If at the very climax of a military campaign we should send out rays which would neutralize the force of gravity, there would be immediate chaos wherever they struck. Huge guns would fly into the air like soap bubbles, marching soldiers would suddenly feel lighter than feathers and would float helpless in the air like a cork in water, completely in the power of their enemies who would be beyond the range of these rays. The picture is humorous and — it may be shown — improbable, but that is how it would actually be if men could bring the force of gravity under their own control."

A MARTIAN AIRSHIP

Kurt Lasswitz in his novel "On Two Planets" describes the conquest of the Earth by inhabitants of Mars. He also describes the special ships built by the Martians for flights in the Earth's atmosphere. For this purpose they produced a special compound which lent them weightlessness and was sufficiently durable. Here is how the author describes it:

"The machine resembled a giant bird without head or legs. Its body resembled a cigar drawn out at both ends. Attached at its rear end was a long flat tail which took the place of a rudder. The ship could stand still in the air without moving. Sometimes it would fold its wings and rudder and, protected from falling by its property of weightlessness, would descend smoothly to the ground. It was 10 m long and 4 m in diameter. There was no screw, but with folded wings the machine could rise vertically. It could also travel rapidly in a horizontal direction, reaching a speed of 200 m per second at a height of 10 km. Two smooth casings, convex on the outside, formed the floor and ceiling of the ship. These were connected at both ends, and at the sides a gap of approximately 1 m was left between them as a window."

THE ANTI-GRAVITY SHIELD OF FAIZANDIER

In his story "Tainstvennyye izobreteniya doktora Khekensou" ("The Mysterious Inventions of Doctor Hackensaw") ("Mir Priklyuchenii," No. 2. 1926), K. Faizandier tells how:

"Man has the capacity to reflect sound, heat, and light. By analogy we may assume that gravity represents a form of energy similar to sound, light, heat, and electricity. If man could somehow obstruct the flow of this energy, this would protect objects from the force of gravity. A shield or reflector of such a kind could be used for all kinds of purposes."

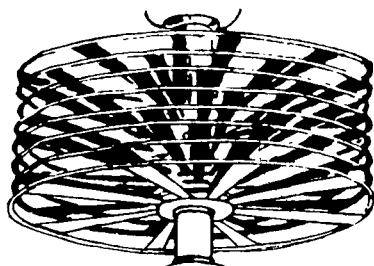

FIGURE 51. The anti-gravity shield of Faizandier

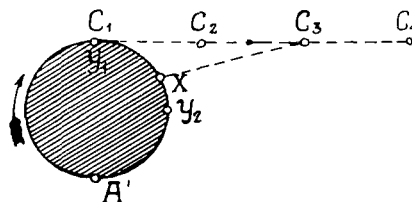

FIGURE 52. Flight around the Earth, according to Faizandier

Here is how the author explains this invention, in the words of Doctor Hackensaw, the hero of the story:

"I discovered a new metal lighter than air which I called "radaluminum," for it contains radium and aluminum. At first I managed to obtain one gram of this metal and was surprised by its lightness, for it rose to the top of a

retort, and when I removed it, it flew up to the ceiling of the laboratory. Then I worked to produce this metal in larger quantities; finally I produced the following as the best form of anti-gravity shield, with sheets made of my metal (Figure 51): a number of thin sheets in the form of wheels with large spaces between the spokes. In order that they should not be carried away into space it was necessary to place a heavy weight on them. By arranging these sheets one above the other and rotating them so as to obstruct the Earth's gravity, I could regulate at will the weight on an object placed above the shield."

With the aid of this shield Hackensaw planned to fly to the Antipodes in a few hours. Leaving the Earth at a certain point Y_1 , the machine, equipped with the shield, would be released from the Earth's gravity and would fly along the tangent C_1-C_4 (Figure 52), every 6 hours reaching the next point in the series C_2, C_3, C_4 , etc. After 12 hours the diametrically opposite point on the Earth's surface A^1 would now be at point Y_1 . But by this time the effect of the shield in the machine would have been cancelled and the machine, attracted by the Earth, would return and fall at point X; it would be possible to calculate the flight so that at the moment of descent point A^1 would be exactly at point X.

N. A. MOROZOV'S OPINION CONCERNING THE "ANTI-GRAVITY SHIELD"

N. A. Morozov of Schlüsselburg (Petrokrepost Fortress), in his article "Vozmozhen-li polet na Lunu" ["Is Flight to the Moon Possible?"], states that the possibility of producing in a laboratory a substance which by its very nature would tend to fly away from the Earth, even to beyond the atmosphere, cannot be excluded theoretically; at the same time the possibility is not excluded of navigation beyond the atmosphere, apart from the rocketry means now proposed. He sees confirmation of this idea in what is seen in the tails of comets, which demonstrates the existence in the Universe of substances repelled by celestial bodies, as the tails of comets, repelled by the Sun, may be repelled also by the Earth and the planets. Furthermore, the existence of magnetic and diamagnetic bodies leads to the idea that it would be possible to achieve either attraction or repulsion if a substance were found which could in some way be transformed from a magnetic to a diamagnetic state. However, such transformations would require the expenditure of no less energy than could be obtained from their exploitation.

MUKHANOV'S "SANAEROZHABL'"*

In his fantastic novel "Pylayushchie bezdny" ["The Flaming Abyss"] (1924), N. I. Mukhanov describes a spaceship called a "sanaerozhabl'", by means of which Earth dwellers in about the year 2400 travel to the Moon, Mars, and the asteroids.

* [The origin of the prefix "San" in this coined word is not clear. "Aerozhabl'" may be rendered as "aerogible" or "airgible," by analogy with "dirigible."]

Principle of flight. By that time the element "nebulium" had been discovered, first on the Moon and later on the asteroids. With the aid of this element the Earth's gravity and the law of inertia were overcome. The "sanaerozhabl'" was constructed on the principle of overcoming the Earth's gravity, and was navigated by means of compensation, in a special accumulator, of a stream of electrons of the element nebulium reaching the Earth from distant stars and automatically extracted from the air.

Construction. In order to overcome a certain difficulty arising during rapid flight through the atmosphere (overheating of the ship due to air resistance), a device was constructed which, when the ship was in motion, formed around itself a cooling air envelope; this permitted maintenance of a normal temperature in spite of the speed of the ship's motion. The ship had the shape of an elongated ellipsoid and, in view of the compression at high speed, was built of a flexible, elastic material which yielded easily to deformation (Figure 53). There were no levers requiring muscular effort, only a series of buttons on the surface of an electronometer to regulate the operations of the machine — that was all, the entire control apparatus, not counting the pilot. In case of emergency, however, the machine could also be controlled automatically.

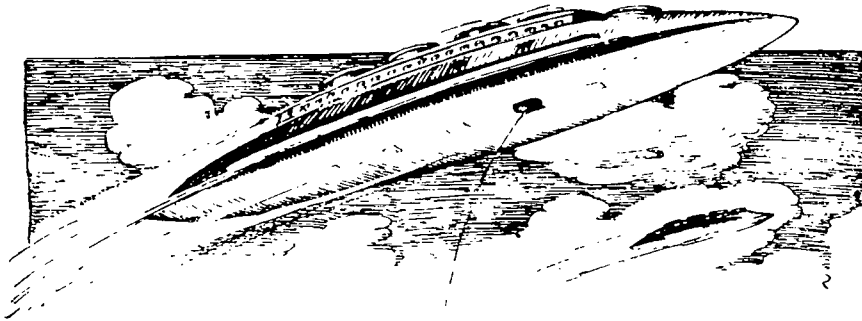

FIGURE 53. Mukhanov's "sanaerozhabl'"

The walls of the ship, made of a special transparent alloy, could, if desired, change their color from extremely light to completely dark, so becoming impervious to any rays or elements existing in the atmosphere. Respiratory instruments were installed inside. Here too was an arsenal of instruments of destruction and protection. There were also two tubes, tremendously powerful refractors, in the forward and rear parts of the ship.

Instruments for measuring time, speed of motion, compression of matter, pressure of the surrounding medium, devices indicating position in space, and apparatus for dispersing the cosmic dust encountered operated automatically and continuously, recording their information on numerous dials.

The row of small periscopes arranged outside the ship caught each ray of light from any direction. The entire mass of light was automatically collected

in special cylinders where it was distributed according to electronic properties and was used to replenish the power consumed by the various devices of the "sanaerozhabl". The speed of flight was 100,000 km/sec.

INTERPLANETARY SHIPS AND COMMUNICATION WITH MARS ACCORDING TO KURT LASSWITZ

The German novelist Kurt Lasswitz, in his novel "On Two Planets," which was translated into Russian in 1925*, describes in fictionalized form the organization of trips between Earth and Mars in special ships based on the application of a "diabarcic" substance which paralyzes the influence of the force or "rays" of gravitation, transmitting them through without resistance.

The book contains many interesting details on the construction and flight of the ships, station equipment, sensation of flying, etc. Below, we recount some of these details taken from the Russian translation. The drawing is based on our descriptions.

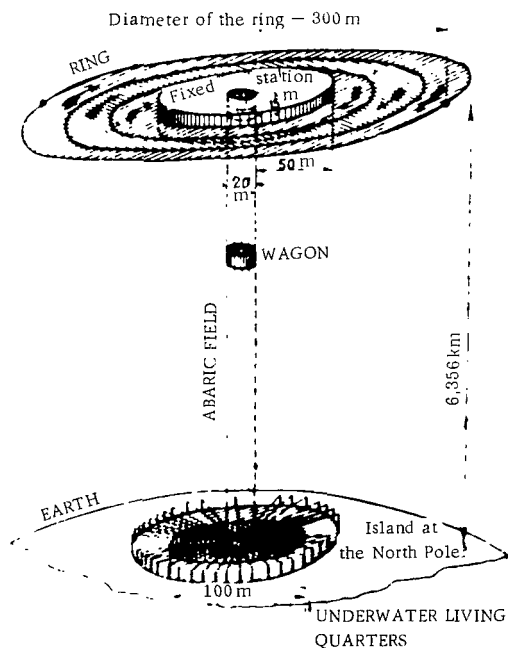

FIGURE 54. The Martian Station at the North Pole of the Earth

1. **Earth station of the Martians at the North Pole** (Figure 54). As operational bases for their colonialist activities on Earth, the Martians chose both of Earth's poles since they are shielded from an influx of human

* Published in German before 1915.

visitors by an endless ice cover. Besides this, the poles, not being involved in the daily rotation around the axis of the planet, make ideal observation points for the movement of ships and stars in space.

The station at the North Pole contained the following arrangements: An artificial circular island was set up with a central cylindrical aperture, about 100 meters in diameter and encircled by a wall. Along the periphery of the island and at various distances from each other stood 144 poles from whose tops to the center of the island there ran a network of metallic wires. The contours of the continents in the Northern Hemisphere were reproduced exactly on the surface of the island. The whole island resembled an enormous raft on which gigantic electromagnets were located. Accommodation, for the most part under water, was installed on the island for the Martians; inside these premises atmospheric pressure and degree of gravity were adjusted to those on Mars.

2. Ring station over the North Pole. In the direction of the Earth's axis, at a distance of one Earth's radius from the surface of the Earth, there soared at an altitude of 6,356 km an unusual structure — an annular body that looked like a gigantic wheel whose plane was parallel to the polar horizon. The ring was 50 m broad, its inner diameter equalled 20 m, so that its complete diameter was 120 m. In addition, like Saturn, it was encircled by broad, slender rings 300 m in diameter. These rings formed a system of flywheels rotating frictionlessly at great speed around the inner ring and maintaining its plane in a position perpendicular to the Earth's axis.

The inner ring resembled a 3-story annular structure about 15 m high. Inside the ring, on the middle floor, there stretched a dense network of wires, lattices and oscillating mirrors.

The ring was undoubtedly subject to the gravity of Earth and if it had been left to itself it would have crashed on the island lying near the Pole; but as it happened a repulsive force from this island maintained it in balance over the Pole at a distance equal to the Earth's radius. The source of this force was the Sun itself, whose energy was thus brilliantly exploited by science and technology.

Finding itself at such an altitude above the Pole, the ring was exposed to the continuous influence of solar rays. The energy radiated by the Sun was accumulated with the help of numerous plane mirrors arranged on both the ring and the surface of the flywheels. On Earth, the inhabitants absorb solar energy almost exclusively in the way of heat and light, but here, in empty outer space, it was discovered that the Sun emits a far greater wealth of energy; in particular it sends out waves of very great length, such as electrical waves, and also waves much shorter than light waves. Here, this very varied and usually unexploited energy was collected and through reflection was transmitted to the island at the Pole. There the aggregate of rays received directly by the island itself represented huge supplies of energy which could be utilized for various purposes.

This ring in essence was only a means of pursuing a very special goal. In the first place, it offered an observation point outside the atmosphere; secondly, it was a station designed to destroy the force of gravity in the space separating the ring from the Earth. The space between the inner aperture of the ring and a depression on the island, namely a cylinder

whose axis coincided with Earth's axis, constituted the "abaric field," i. e., an area which the force of gravity did not affect. All bodies found in this cylindrical space were not attracted by the Earth. The abaric field acted on its surroundings such that all objects falling within them were irresistibly drawn to it.

A field of this kind, where the force of the Earth's gravity was not effective, could exist thanks to another opposing force balancing it. Inhabitants of the Pole knew how to extract the force of gravity from chemically active heat and light rays. To this end the rays were directed to the inner part of the ring and entered the "gravity generator." This was an apparatus transforming heat energy into gravity. Another apparatus of this kind was located in the central depression of the island.

For the purpose of communication between the island and the ring, a wagon moved up and down along the abaric field. The difficulty in the work of the engineers at both terminal stations lay in the regulation of the force of gravity so as to provide the opportunity at any time, and with the desired speed, of drawing the wagon towards the island or the ring.

In outward character the abaric field had very little to be distinguished from its surroundings; it could be recognized only by the ascending air current and by the lateral flow of air caused by it. However, because of the small diameter of the field the quantity of ascending air was so negligible that neither clouds nor fog formed; moreover, from the island and the ring there emanated such powerful radiation that water vapors were barely condensed before they were again transformed into a gaseous state.

The stations were equipped with differential baroscopes whose indicators could accurately show where the wagon was at a given moment. The operator at the station, with the pertinent device at hand, could regulate the movement of the wagon, and on its approach to the station it was received by a sliding net.

A sign on the ring building proclaimed "Outer Earth Station." On one of its doors there was the inscription "Departure for Mars."

3. Diabaricity. The Martians succeeded in solving the mystery of gravity; this left in its wake an unforeseen revolution in technology and made them masters of the whole solar system.

If the weight of a body could be transformed into another kind of energy, the body would thereby become completely independent of the force of gravity; the latter would be transmitted through this body or surround it without affecting it — the body would thus be "diabaric"; it would be as little attracted by the Sun as a piece of wood by a magnet. This body could be so free of the influence of the planets and the Sun that it could move freely in outer space; and then it would be possible to find a way from one planet to another, from Mars to Earth. And this the Martians succeeded in doing. They discovered a special alloy which completely insulated the body from the force of gravity. The Martians discovered that the force of gravity, like light, heat and electricity, is propagated in outer space by wave movement. But, at the same time, while the speed of the propagation of energy, received by us in the form of light, heat and electricity, approaches 300,000 km/sec, the speed of gravity is a million times greater. According

to Martian calculation, gravity is propagated in space at a speed of 300,000 million km/sec. *

A body that is impenetrable to light is known to be opaque: if it were fully penetrable it would be absolutely transparent and we would be unable to see it, just as we are unable to see air. The Martians proved that this held true for gravity. Bodies are heavy because they absorb waves of gravity. Bodies are mutually attractive only when one does not allow the waves of gravity emanating from the other to penetrate. Bodies which do not absorb the gravity waves of the Sun or the planets, freely transmitting them, do not attract and are weightless; they are diabaric — transparent for gravity and thereby weightless.

The Martians discovered that stellite, a substance encountered on their planet, can be subjected to a process that makes it transparent to waves of gravity, after which it ceases to be attracted by Mars or the Sun. However, the attempt to achieve absolute weightlessness of bodies was unsuccessful, but then absolute transparency of bodies will never be mastered. In any case, they were successful in reducing the influence of gravity on the diabaric body to such an extent that gravity became imperceptible. Reducing or increasing body susceptibility to gravity was possible by imparting to the body an initial speed and, of course, wrapping it in a stellite envelope, controlling its movement in outer space, utilizing the attraction of the planets and the Sun.

4. Movement of the wagon between Earth and the ring. This is how Lasswitz describes the voyage in the wagon:

"The operator locked the wagon, after putting up the sliding door through which the passengers setting forth from Earth for the ring had just passed. As soon as the wagon was locked a signal was heard. The Martians quickly settled in the narrow compartments along the walls.

"To prevent themselves from falling during movement of the wagon, they inserted their feet into special sockets attached to the floor, with both hands firmly seized brackets in the side walls, braced their backs against soft padded walls and rested their heads against the depressions between the pillows.

"Another signal was heard; the light became so dim that only the hanging lamps were discernible.

"Then came a dull crackle. The passengers felt a slight jolt followed immediately by the sensation of being riveted to the floor. This was so because there was a reservoir filled with strongly compressed air under the wagon; at the moment of release the wagon was hurled upward along the abaric field at a speed of 30 m/sec. The force of gravity was no longer active in the field. Up to this moment, a gravity usual for the Martians had reigned within the wagon, but now it was completely destroyed.

"The feeling gripping the people could be called neither unpleasant nor very strong — it was more like the sensation of sitting in a bathtub with the one difference that there was no water in the tub; it was possible to become accustomed to the feeling rather quickly; a slight rush of blood to the head was the only other thing noticed. The lamps went on again and several men cautiously emerged from their compartments. They liked the feeling of being completely weightless. Three Martian women joined hands and started a graceful dance around the room, moving nimbly from wall to floor, from floor

* Some scientists are now putting forward the suggestion that gravity is propagated with the speed of light.

to wall. In their whirling scarves they looked like fairy-tale elves conducting their aerial round dance on a moonlit night. . .

"But then another signal rang out and they scampered back to their compartments. The lamps were extinguished with the exception of the dully glimmering lamp in the middle of the room; however, it was so weak that the surrounding objects remained in complete darkness. Up to now the force of the Earth's gravity had been neutralized and the wagon in the course of six minutes ascended to an altitude of around 10 km as a result of the jolt it had received. Here the air was already sufficiently rarefied, and the ascent could be accelerated. Reigning in the field now was the force of "countergravity" and the wagon started to "fall up" to the ring.

"The passengers indeed began to feel as if the floor were slipping from under their feet since it was now turned towards the ring and movement had been accelerated. Again it became light and the passengers left their compartments and moved about in the wagon. In about a half hour after take-off from Earth, the passengers were again to receive the signal to return to their places. The wagon had by now reached its highest speed and a good part of the journey was behind it. It was time now to reduce speed and regulate it in order that the flying vehicle land exactly inside the ring. For this purpose the Earth's gravity was restored, but at this altitude it was not as powerful as at the Pole and more or less conformed to common Martian conditions; at the ring it was four times weaker than on the Earth's surface. The flying ship was now reminiscent of a body thrown above with great strength, and with diminishing speed was now approaching the highest point of its journey. Corresponding to the change in force acting in the abaric field, the floor of the wagon was to turn for a second time, toward the Earth, and the travelers standing in their compartments were waiting tensely for this swing. Once this turn was made they could again move freely about the wagon right up to their arrival on the ring.

"The vehicle floated so smoothly to the ring that one was scarcely aware that it had stopped. The door flapped open; some passengers stepped into the middle gallery of the ring, others to the lower gallery which surrounded the ring from the outer side, and others to the upper gallery.

"Below the entire lower gallery there was an overhang that resembled a balcony and it seemed that from here one could take immediate delight in space; in reality, the perfectly transparent outer wall separated the viewers from the vacuum. That part of the gallery in which some passengers happened to be did not face the Sun and the ring, located above it, shielded them with its entire breadth from the solar rays, despite the fact that the Sun was very low. They were surrounded by a mysterious dusk, only one edge of the gallery was slightly illuminated by the Moon, and on the ceiling above them there was reflected the light of Earth.

"Similar to the ring over Earth, a station was constructed above Mars, located on the axis of the planet, 3,390 km above the South Pole. In order to transmit communications between the ring and Earth light rays were used; not only were telegrams dispatched but with the help of light rays telephone communications could be transmitted. The electromagnetic oscillations of the telephone were turned into photochemical oscillations and in this way were received by the apparatus at the second station. "

5. The interplanetary ship and the history of flights in it. The Martian interplanetary ship had no propeller, rudder or anchor. Movement in outer

space was induced by a change in the diabaricity of the ship which was controlled by so-called "guiding" or "correcting" projectiles. These projectiles were released by special devices in those cases when direction or speed of movement was to be changed. The ship usually held up to 60 passengers. The material from which the ship was made — "stellite" — was very durable in the cold of outer space, but in heat and humidity it rapidly lost its durability. Besides this, on falling into the Earth's atmosphere the ship could only fly as a balloon, and storms and winds posed a danger to it. Therefore, for the flight in the Earth's atmosphere, the Martians built special vehicles and risked landing in their interplanetary ships only at the Poles, and only on the first flights from Mars to Earth at that.

The development of flights to Earth had its history. When the first ship was constructed, one Martian flew in it but he never returned. Did he fly beyond the solar system, to the sea of fixed stars? Did he crash on the Sun? Is his ship flying around the Sun or another planet as a new satellite? No one ever knew. However, this did not stop the courageous explorers. They had already reached an understanding of the theoretical possibility of interplanetary travel; to trust in outer space no longer seemed mad — it was an urgent cultural mission and, consequently, a moral obligation, a duty.

The history of the conquest of outer space by the Martians abounded in sacrifice as does the history of human discoveries on Earth. But after a long absence, one of the flying machines returned and circled the Earth three times in a very low orbit. Another vehicle landed on the Earth's satellite — the Moon. And, finally, still another was lucky enough to reach the North Pole of the Earth. Then there came a landing at the South Pole and gradually the Martians built their main station at the North Pole and a less important one at the South Pole, since they could use the North Pole station only when flying to the Northern Hemisphere.

CRITICISM OF LASSWITZ'S SCHEME

The major weakness in the scheme of Kurt Lasswitz is the lack of a material which would be completely transparent to gravity waves, even admitting their existence, and which therefore would be weightless. But supposing such a material is obtained, the question remaining open is the weight of people, food and other objects within the ship that are not made of such a material. It is true that if the proportion of the mass contained within the envelope of the ship is small, such a ship will fly easily in interplanetary space, but considerable energy will be required.

Chapter IV

FLIGHTS WITH THE AID OF RADIATION PRESSURE

In this chapter we will examine the novelists' ideas of flights in outer space by the pressure of light rays. As we know, light rays exert a certain pressure on the body surface; the larger the surface and the radiation intensity and the smaller the mass and the drag of the medium, the greater is the radiation pressure.

THE PROJECT OF LE FAURE AND GRAFFIGNY

The two French novelists Le Faure and Graffigny in "Aventures extraordinaires d'un savant russe" (1889) describe the method by which the scientist and his companions are able to fly from the Moon to Venus. The propulsion force for such an apparatus is the repulsive influence of solar rays. All that was needed was to build a huge mirror which would reflect the solar rays and a vehicle which would be repelled by these rays. In a conversation with the Selenites, dwellers of the Moon, the scientist learns that such a vehicle exists on the Moon and that he and his companions could use it.

A parabolic reflector made of an element reflecting light (selenium), standing 50 m high and 250 m broad, was installed at the top of a mountain.

The vehicle itself was composed of a hollow balloon (Figure 55), made of selenium with a diameter of 10 m. At the bottom there was an opening 1 m in diameter; four cruciform poles reinforcing the opening served as supports for the column of selenium which terminated above in a huge circle over which was suspended the floor of the chamber housing the travelers. The relation of this chamber to the balloon surrounding it was such that the chamber could remain still while the balloon revolved around it with breathtaking speed. This was achieved by a structure similar to that usually given to revolving turrets at observatories, i. e., the circle by which the column was terminated could slide along the bottom of the chamber on bronze rollers.

Since the lifting force was inadequate for the conveyance of five passengers from the Moon to Venus, it was decided to detach part of the vehicle on the way and fly to Venus in it. The part chosen was the gondola (the former lid of the balloon) which was affixed to the surface of the equatorial selenium circle, 30 m in diameter, by strong metal cables. The circle was to play the role of a parachute during entry into Venus' atmosphere.

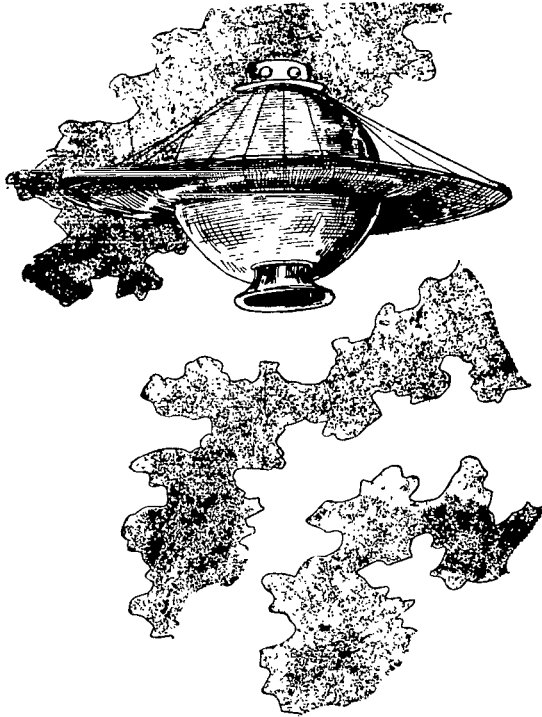

FIGURE 55. Le Faure and Graffigny's ship reflecting light rays

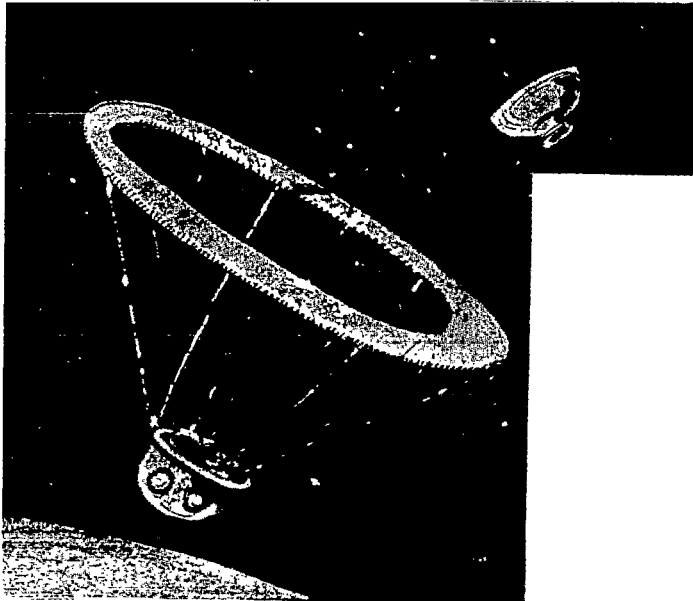

FIGURE 56. Descent onto Venus

At the moment of take-off, the vehicle was placed in the focus of a reflector surrounded by revolving mirrors of selenium. When the latter were turned in the appropriate manner, the vehicle, exposed to the repulsive force of the rays, took off with its passengers for Venus at a speed of 28,000 km/sec.

When the vehicle reached the neutral zone of attraction between the Moon and Venus, its lid with the equatorial ring was detached and the travelers, dressed in space-suits, prepared for the flight.

The authors describe the separation of the five from the vehicle thus:

"Suddenly, some powerful force tore them from their places and threw them upward. . . Behind them flew everything — instruments, furnishings. . . Stunned, shattered, our heroes found themselves on the dome-shaped ceiling of the cabin under a pile of rubble. . . When they opened their eyes and got to their feet they saw that they were being carried in a parachute, the canopy of which was the huge flat selenium ring and the basket — the dome of the former cabin."

On the way to Venus the travelers ran into a raging storm and as a result fell to the surface of the ocean, where they were saved by the inhabitants of Venus (Figure 56).

From Venus they flew on in the same vehicle, and helped by the same repulsive action of light set off for Mercury. On approaching the latter's atmosphere they decided, in order to descend, to jettison the heavy cabin with all its equipment and continue the journey in the outer selenium balloon which weighed little, was voluminous, and could enter Mercury's atmosphere far more slowly than if the whole vehicle were to enter. And that is what happened; they safely jettisoned the cabin and commenced the descent towards Mercury. However, the speed was so great that they were thrown onto its surface; luckily, they fell on the slanting surface of a mountain and the oblique blow somewhat softened the force of the impact; their balloon, however, instead of one savage jolt received dozens of them and rolled and bounced down the precipitous slope of the mountain.

B. KRASNOGORSKII'S INTERPLANETARY SHIP

In 1913, a book entitled "Po volnam efira" ["On the Waves of the Ether"], written by B. Krasnogorskii, was published in St. Petersburg. The author tells of the flight of four people from Leningrad to the Moon and the fall of their vehicle into Lake Ladoga on their return.

The goal of the flight — descent onto Venus — was not achieved. For this flight a vehicle was constructed at the Obukhov Plant and called "Victor of Outer Space." It consisted of a wagon in which the passengers were accommodated and a large circular mirror. The author's idea was to have the rays of the Sun exert pressure on the polished surface of the plate glass and propel it with enormous speed into outer space. Turning the mirror relative to the wagon and the Sun, and in accordance with the forces of gravity of the Earth and the planets, radiation pressure could be reduced and the direction of movement slightly changed.



KRASNOGORSKII'S INTERPLANETARY SPACESHIP
(GENERAL VIEW)

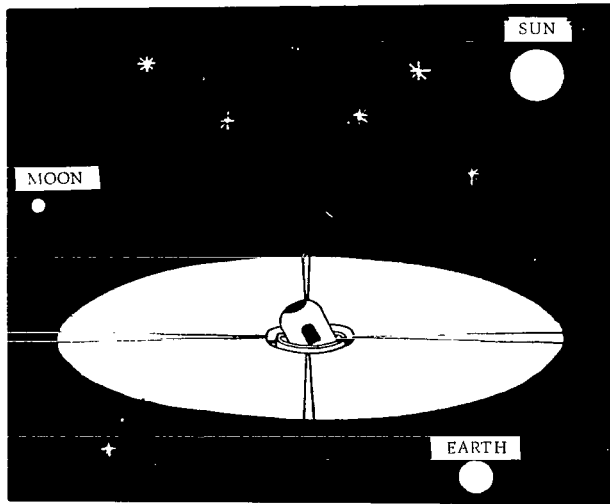

FIGURE 57. Krasnogorskii's ship flying in outer space

Not far from the Moon the passengers ran into a meteor stream, and the mirror was wrenched from the wagon, which was carried away by the stream to Earth where it fell into Lake Ladoga; safe and sound, the passengers were fished out of the lake by a steamer.

Passing over the distinct absurdity of the wagon falling safely into the lake, let us fix our attention upon some interesting calculations and the structure of the vehicle proposed by the author.

Principle of flight. The pressure of solar rays in comparison with the force of body weight increases as the weight decreases and the body surfaces increases. A drop of water with a diameter of 0.75μ (μ — micron = $1/1,000$ mm) would rush from the Sun because of this radiation pressure at a speed of 550 km/sec. A further reduction of its diameter would bring its flight to 9,000 km/sec. In general, a drop of water should be no more than 1.5μ in diameter in order to rush into outer space under the influence of radiation pressure while overcoming solar attraction.

An interplanetary vehicle that could utilize this pressure for propelling purposes must fulfill two conditions: it must be light and must possess a large reflection surface. Its chief constituent would be a huge mirror of extremely thin sheets of polished metal. The sheets would be placed on a durable frame of an especially light alloy from which the hull of the passenger wagon would be made, while the wagon would be hinged to the mirror. The particles of ether striking the mirror would bring the vehicle into motion and carry it into outer space.

The flight must be launched in the morning or evening when the Sun's rays fall obliquely upon the Earth.

KRASNOGORSKII'S INTERPLANETARY SHIP
Section through AB

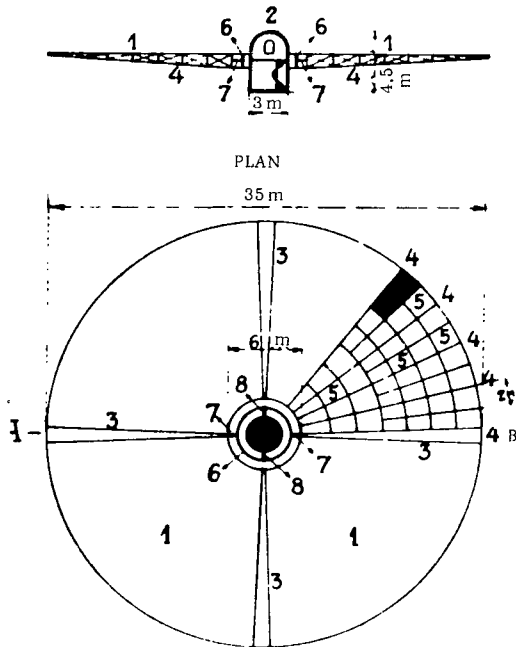

FIGURE 58. Scheme of Krasnogorskii's ship

A question now arises: how about the return to Earth? Radiation pressure only repels, it does not attract. But here to the rescue comes the force of gravity. By turning the mirror edgewise to the light, the effect of radiation pressure can be stopped, or by drawing black material over the mirror, it is possible to weaken it considerably. Then the vehicle, under the influence of the force of gravity would start to fall at the desired speed. But then another question arises: how to slow down or stop the vehicle if it is carried into space under the influence of radiation pressure at a speed, let us say, of 250 km/sec. If under these conditions radiation pressure ceases, the inertia may exceed solar gravity and the vehicle might fly outside the boundaries of the solar system. To this the author replies that full speed (250 km/sec) is not necessary for travel from Venus to Earth, that the vehicle may be set directly for Earth and then slow down in its atmosphere.

A second objection against the flight is that the travelers are under threat of an encounter with meteorites. The author's reply is that there are not so many meteorites and all that is required is a bit of maneuvering.

The third objection lies in the fact that the vehicle in all probability would have to go through the region of zodiacal light which, in view of its finite density, would represent a serious danger, slowing down movement, due to which the passengers might run out of supplies of oxygen and food. Apparently the author did not find this of sufficient importance, for the objection remains without an answer.

The fourth objection arises in the event of a possible fall toward the Sun; the passengers resort to the force of radiation pressure but the mirror,

unable to withstand the force of pressure at the precipitous fall of the vehicle, may be demolished and the vehicle, deprived of resistance, will fall onto the Sun. On this subject, too, the author remains silent.

KRASNOGORSKII'S INTERPLANETARY SHIP
WAGON

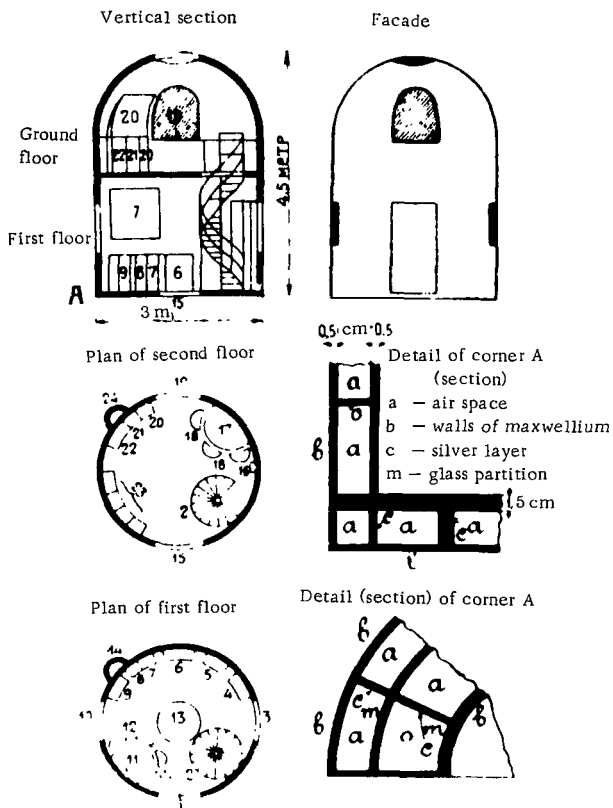

FIGURE 59. Gondola of Krasnogorskii's ship

The fifth objection involves the danger of the cold of outer space on the shadow side of the vehicle and the heat at the side illuminated by the Sun. However, this is neutralized by the special structure of the wagon walls and the insertion of shields at the windows.

Structure of the vehicle. Figures 57, 58 and 59 give different views of the ship; Figure 57 shows it during its flight in interplanetary space under the influence of solar rays, Figure 58 presents a general view, and Figure 59 a view of the wagon and details of its wall structure.

General structure of the ship (Figure 58). Its propulsive part is the circular mirror with an outer diameter of 35 m and an inner one of 6 m. It is composed of a rigid frame with a network of beams on top, supporting reflecting

polished sheets. In the sketch, 1 indicates the surface of the sheets, 4 the lattice beams, 5 the frame which is seen when the sheets are removed. Curtains of black silk cover the reflecting surface when it becomes necessary to reduce radiation pressure (3). Inside the central opening the ring (6) is found, joined to the mirror axis (7-7). The wagon (2) is connected to the ring (6) by the axis (8-8). In this way the wagon is suspended from the mirror by a universal joint and through control by special gears can assume any inclination relative to the mirror, as Figure 57 shows. The frame and sheets of the mirror and also some parts of the wagon are composed of alloys of aluminum, lead, vanadium and some light metals; the specific weight of the resulting alloy is equal to 1 and it is called maxwellium. The lead in it is added to stop radium rays and the like emitted by the Sun. The vanadium is added to extend durability. The thickness of the reflecting sheets is 0.1 mm. The thickness of the main rods of the frame is equal to 1 cm. The overall length of all such rods is 1,000 m. The dimension of the frame sides on which the sheets are fastened does not exceed 2 m.

The curtains are stretched over the mirror by a system of cords.

The wagon is shaped like a cylinder with a spherical roof (Figure 59). It is 4.5 m high and 3 m in diameter. There are two floors, each of which is about 2.25 m high. The upper floor contains two side windows and one upper one. The lower has two side windows, one lower window, and one side door.

The wagon walls, as we see from plan of corner A are double; from the space within them (a) the air is pumped out, and because of this a heatproof wall is obtained. The partitions (m) between the walls are of glass. The windows are also double and hollow between the glass panes.

Calculations for the vehicle. The force of attraction of the Sun at a distance of 150 million km (average radius of the Earth's orbit) consists of only 0.0006 times the force of gravity on the Earth's surface. Nearer to the Sun, for example, where Venus has its orbit, gravitation to the Sun is greater but so is the radiation pressure of the solar rays there. By the latter only pressure of light rays is understood. It is equal to $\frac{2}{3}$ of a dyne on 1 sq. m of black surface, and for reflection twice as much i. e., $\frac{4}{3}$. In other words, if some substance weighing $2\frac{3}{11}$ g were spread out on the mirror surface in an area of 1 sq. m, the pressure of light could raise it if it were in outer space and subject only to the attraction of the Sun. Support does not depend upon the distance from the Sun since the force of gravity and radiation pressure change proportionally. If the weight of the mirror is reduced by $\frac{3}{11}$ g, i. e., to 2 g, it rushes from the Sun at the speed of ca. 250 km/sec, i. e., with a velocity sufficient to tear the body from the sphere of Earth's gravity.

Thus, the lifting force of light pressure per sq. m of a mirror weighing $\frac{3}{11}$ per sq. m is 2 g. If we take the alloy of aluminum with magnesium (magnalium) with a specific weight of ca. 2 and make plates 0.1 μ thick, 1 sq. m of them will weigh a total of 0.2 g and, under the influence of light pressure, they will not only rush into space but will be able to bear a load of $2 - 0.2 = 1.8$ g (note: similar thin sheets are being made out of gold - tinsel).

A wagon with passengers and supplies of food weighing around 2,800 kg requires an area of mirror

$$\frac{2,800 \cdot 1,000}{1.8} = 1\frac{1}{2} \text{ million sq. m} = 1\frac{1}{2} \text{ sq. km}$$

not counting the frame of the mirror itself. Thus, the problem appears insoluble. However, one factor is overlooked: in the Sun's rays there are, in addition to light rays, a number of other components whose pressure is considerable. In the table below the lifting force of these rays is given:

Solar radiation	Force, taking light to be 1	Lifting force on 1 sq. m of mirror in g
Light	1	2
Chemical	1	2
Heat	3	6
Electric	5	10
α radium	624	1,284
β "	304	608
γ "	8	16
Unknown	237	474
Total	1,201	2,402
Rounded off . .	1,200	2,400

In this way, the lifting force of radiation pressure is capable of lifting 2.4 kg with the help of 1 sq. m of mirror.

Further, in order to lift a vehicle with the help of such hypothetical rays, the author assigns to maxwellium a specific weight of 0.96. With the additions the specific weight of maxwellium is raised to 1; from this are constructed the wagon, frame and sheets of mirror.

Thus, the lifting force per sq. m of mirror is 2.4 kg; the weight of 1 sq. m of mirror, with thickness of sheet 0.1 mm and frame, is 0.4 kg; the weight of the wagon, supplies and passengers is 1,800 kg; the remainder of the lifting force of the mirror is $2.4 - 0.4 = 2$ kg; its area is $\frac{1,800}{2} = 900$ sq. m.

The speed of the ship's movement is 250 km/sec, i. e., 8 times greater than the speed of the Earth.

Weight of vehicle and its parts

Mirror (whole)		per sq. m
Frame	140 kg	0.16 kg
Beams supporting sheets. . . .	27 "	0.03 "
Reflecting sheets	90 "	0.10 "
Curtains (0.11 kg per sq. m) .	99 "	0.11 "
Unforeseen	4 "	
Total	360 kg	0.40 kg

Wagon

Structure	635 kg
Joint to mirror	85 "

Equipment and passengers

Interior fittings (stairs, wall padding, etc.)	12 kg
Passengers (4)	250 "
Canned food	170 "
Oxygen and hydrogen	525 "
Oxyhydrogen device for obtaining water, air purifier and stove	16 "
Guns, charges, clothing, bed linen, inflated rubber cushions, books, instruments and miscellaneous	80 "
Unforeseen	27 "
Total	1,080 kg

Total

Wagon	635 kg
Joint	85 "
Equipment and passengers	1,080 "
	1,800 kg
Mirror with frame and curtain	360 kg
Complete weight of vehicle.	2,160 kg

Excess radiation pressure or lifting force $2,400 - 2,160 = 240$ kg

Equipment and provisions (for 60 days)

Food. For an adult, 18.8 g of nitrogen and 281.2 g of carbon are required daily. Since food in which these elements are found is not totally assimilated by the organism, the weight will be greater, namely 700 g per person per day, or 2.8 kg per four persons. Supplies for 60 days will weigh 168 kg. Water supplies, counting on $1\frac{1}{2}$ liters per day per person, or in all $1\frac{1}{2} \times 4 = 6$ liters, or kilograms, for 60 days will be $6 \times 60 = 360$ kg.

Oxygen for breathing. Man needs 20 liters of oxygen an hour and four men would require $20 \times 24 \times 4 \times 60 = 115,200$ l for 60 days. Since the air contains about 21% by volume of oxygen, the necessary quantity of air would have to be around 550,000 l, which corresponds to a house with six large rooms. Therefore, the supplies of oxygen must not take the form of air, but another form. Nitrogen does not diminish in breathing. The weight of oxygen, with a volume of 115,200 l, is 165 kg.

Oxygen was earlier extracted from manganese peroxide; when heated, 100 g yielded 9.6 g of oxygen. Thus, to obtain 165 kg of oxygen a load of 1,700 kg of this peroxide would have to be taken, which is impossible. Therefore, an apparatus would have to be devised which would not only convey oxygen for respiration but also yield heat for cooking and heating and light for the wagon. Water would also be obtained from it by combining two volumes of hydrogen and one of oxygen. This apparatus would consist of two large tanks containing liquid hydrogen and oxygen. The tanks, like the wagon, would have double walls and would be enclosed in that part of the wagon shielded from the Sun. From them, through pipes with stopcocks, the hydrogen and oxygen could flow into two other vessels located on the opposite side, so that the

rays of the Sun could beat down on them. Because of the high temperature here the liquids would evaporate and be transformed into gas. Two pairs of stopcocks, arranged so that the hydrogen and oxygen flowing from them intermixed, would be fixed to other vessels: one pair of stopcocks in a small maxwellium oven, and the other under a platinum plate. If one were to open them and light a match, the hydrogen and oxygen flowing would be united or, in other words, the hydrogen would burn and form a pale, very hot flame. This would heat the stove for cooking and bring to white heat the calcium plate which would then start to give off a blinding (Drummond's) light. Steam would be the product of combustion; this, when cooled, would provide the passengers with drinking water. For breathing purposes the opening of one oxygen stopcock would be sufficient. The tanks would hold 40 kg of hydrogen (i. e., just enough to obtain 360 kg of water) and 485 kg of oxygen; this supply would satisfy all needs.

Absorption of carbon dioxide. In the wagon there is a vessel with a liquid that absorbs the carbon dioxide exhaled. After saturation, the vessel with the liquid is carried into outer space and the carbon dioxide is rapidly released from the solution; the liquid brought back into the wagon again absorbs the carbon dioxide, etc. An automatic device is required to push the vessel in and out.

Miscellaneous objects. Cushions and mattresses (air-inflated), two astronomical telescopes, thermometers and barometers.

Velocimeter. This was the name of an instrument to measure flight velocity. The principle of how it works is given below and it may be more easily understood by comparing light waves with sea waves. Let us imagine sea waves flowing into shore, and suppose that 20 such occur each minute; now, if we seat ourselves in a boat and ride against the waves, we will encounter more than 20 per minute, but if we sail in the same direction as the wave movement we will intercept less than 20. Light is also a wave, propagated from the source of light; therefore in the movement towards the source of light we meet more waves than in moving away from it. Common sunlight consists of seven colors: red, orange, yellow, green, sky-blue, dark-blue and violet. The difference between the colors lies in the number of waves per second. When we move against the light waves, the colors of the spectrum seem to shift to the violet end where the oscillations are faster and the frequency of waves higher. In the solar spectrum there are dark, so-called Fraunhofer lines. With a displacement of spectral colors there is also a displacement of these lines whose position in the spectrum is precisely determined. One can judge the speed of movement towards the Sun by the extent of this displacement. In movement away from the Sun, the lines move towards the opposite, red end of the spectrum and thus we are able to determine speed in a vacuum.

Movement perpendicular to the rays may be calculated by stellar aberration, or the change in the visible position of a star under the influence of such a movement.

The whole instrument consists of a combination of a spectroscope and a precision goniometer provided with matching scales. One glance at it suffices to yield the speed and direction of the apparatus during its journey to Venus.

Distance measuring instrument. A device to measure the flight from the Sun and from Earth was constructed, based on the following principles: the

force of gravity changes with distance. A sensitive spring balance bearing a small load was taken. According to the departure or approach from Earth and the Sun, the spring will straighten or bend because of the change in weight. A small scale indicates the relation between the height of the load and the distance from Earth and the Sun.

Interior fittings. The walls were covered with a soft material, the windows with thick black curtains; the outer wall was silver-plated to reflect solar rays and prevent them from entering.

Arrangement of objects by floors (see Figure 59).

First floor (to the right starting from the door):

1. Door
2. Spiral staircase
3. Side window
- 4—5. Cabinets with tableware, kitchen utensils and provisions
6. Stove
7. Oxygen stopcock and handles of the levers for moving the mirror
8. Instrument for removing carbon dioxide
9. Balance (measuring distance) and velocimeter
10. Second window
11. Table with overhanging lamp
12. Four chairs
 - a. Tank under the table for the flow of water formed during burning
13. Window in the floor
14. Apparatus for the storage of liquid hydrogen and oxygen

Second floor:

15. Window above door of first floor
2. Spiral staircase
16. Cabinet with instruments and supplies
17. Table with lamp
18. Chairs
19. Window
20. Stopcocks and levers
21. Carbon dioxide absorber
22. Balance (measuring distance) and velocimeter
23. Cabinets
24. Apparatus for the storage of liquid hydrogen and oxygen

(Note: items 14 and 24 are attached above and below and form a kind of bulge at the wagon surface).

Preparation. The time selected for the vehicle to depart from Earth is either sunrise or sunset, when the rays of the Sun fall obliquely upon the Earth. The mirror is inclined toward the horizon in order for the rays to fall directly on its surface. The apparatus is placed on a special platform with four cross-shaped beams protruding from behind the mirror (Figure 60). At the ends of the beams are fastened the cables of the four balloons which will lift the platform with the vehicle on it high over the Earth until radiation pressure lifts the vehicle off the platform and carries it away into outer space.

Calculation of volume of balloons:

Weight of vehicle	2,160 kg
Weight of platform and balloons	4,340 "
Total	6,500 kg

Assuming that the balloons are filled with hydrogen and that the lifting force of one cubic meter is equal to 1.2 kg, we find the volume of the four balloons $V = \frac{6,500}{1.2} = 5,400 \text{ m}^3$. The volume of one is 1,350 m^3 ; its radius is equal to 7 m.

The departure took place at 6 p. m. July 28 from Mars Field in Leningrad. Evening was chosen because the apparatus being lifted above would start to lag behind the Earth; in the morning it would have had to overtake the Earth, which would have been inconvenient. Promptly at 6 o'clock, the cables binding the platform to Earth were cut and the balloons bore the vehicle aloft.

Flight. Flight time to Venus alone was calculated at 41 days. Adding takeoff time from Earth and landing on Venus, the total would come to 42 days. This part of the journey would be completed under the influence of solar attraction. The return journey under the influence of radiation pressure would be made at a speed of 250 km/sec and would require a total of two days. In the event of a delay in takeoff from Venus because of clouds, there would have to be a time allowance of, say, 60 days for the entire journey there and back, with the possibility of waiting for 16 days on Venus for the weather to clear.

At first the vehicle was lifted to an altitude of $8\frac{1}{2}$ km with the help of balloons. Here the rays of the Sun lifted it off the platform. For a second it remained stationary in the air and slowly, then faster and faster it sailed off into outer space. After a short while the balloons and the platform fell to Earth and were found 60 km from Leningrad, with a note from the travelers. Soon the speed of the vehicle reached 150 km/sec and it simultaneously flew away from Earth and from the Sun, rushing in the opposite direction to the Earth's movement.

Before flying to Venus, the travelers set their bearings for the Moon, changing the direction of the flight, complying with the forces of gravity and radiation pressure, and changing the mirror inclination to the rays of the Sun. When the distance between the vehicle and the Moon was 1,000 km, they again changed flight direction and flew towards Venus. The subsequent route of their flight was proposed as such: to fly about 600,000 km more and stop the vehicle, turning the mirror edgewise to the Sun. At this time they would be further from the Sun than Earth and the Moon. At the same time, the vehicle, under the influence of solar attraction, would start to fall toward the Sun, but this fall would be very slow at the onset so that the Earth and the Moon would be able to pass between the Sun and the vehicle; as a result of this the vehicle would increase its speed of movement and in the end it would fall toward Venus.

Disaster. During the journey "Victor of Outer Space" ran into the Perseids (July 28) — a stream of stony meteorites of various size. When the travelers saw these stones gleaming in the rays of the Sun and flying past them, they changed direction and speed, reckoning on "floating along the course of the stream" with the speed and in the direction of the movement of the stones; however, although the vehicle stopped moving away from the Sun, meteoritic dust started to deform the mirror, bending its sheets in the frame. In the attempt to avoid this pressure the vehicle was moved away from the Sun but the stream intensified and started to carry the vehicle in its grip in the direction of the Sun and away from Venus. Finally, large stones started to pour down on the vehicle. Then came a powerful blow after which

the vehicle was carried along by the stream at a speed of 42 km/sec. Neither the travelers nor the wagon were affected but the mirror was torn off and the machines and controls were lost, leaving the crew helpless.

Descent to Earth. It appeared that the stream of meteorites proceeded along with the wagon to Earth and precisely into Lake Ladoga. The wagon floated to surface and sailed along until it was picked up by a steamer.

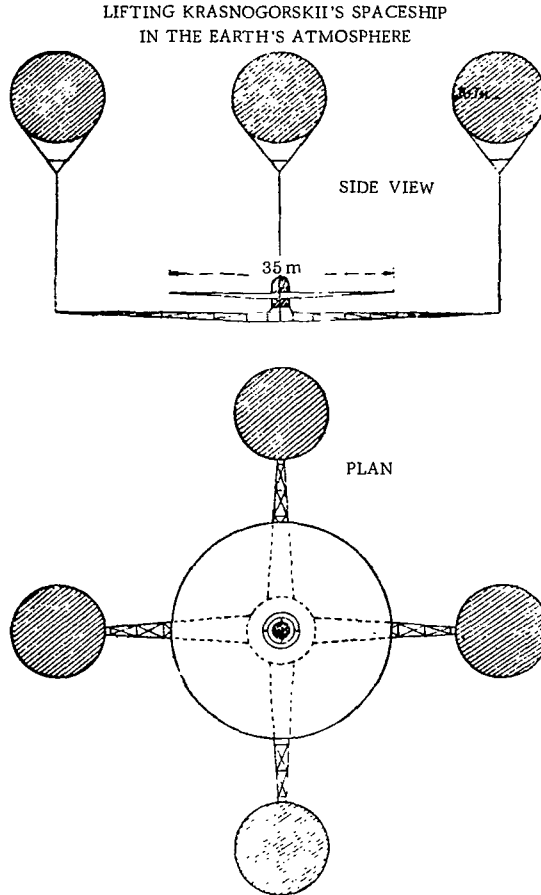

FIGURE 60. Krasnogorskii's method of takeoff

The proposed descent to Venus was to have taken place on top of a high mountain where solar rays are not hidden by clouds; but since this might have proved not so easy to achieve, the plans were to have the ship dismantlable so that in the event of necessity it could be dismantled by parts and transferred to a more suitable place. Since solar energy on Venus is twice as great as on Earth, the takeoff would be easier than on Earth.

In the second volume of this work, "Ostrova efirnogo okeana" ["Islands in the Ether Ocean"] (Krasnogorskii and D. Svyatskii, 1914), a new flight with the same crew on the same vehicle "Victor of Outer Space" is described. The travelers take off from the environs of Leningrad, fly through the atmospheric layers and are carried to Venus. En route they are

overtaken by enemies who had earlier stolen the designs of their vehicle and constructed one for themselves, which they called "Patria", in a neighboring country. A volley of bullets from "Patria" sprays the "Victor of Outer Space" and it loses its controls; it is carried by the force of solar light pressure in the direction of the asteroids, Mars, comets and Jupiter with its satellites. Here the travelers are successful in repairing their craft and turning back. They reach Venus and on descending find the wreckage of the "Patria", which suffered disaster in its attempt to land on Venus. The perpetrator of the stolen designs has been killed and his two companions become friendly with the passengers of the "Victor", but one of them dies of a scorpion bite.

Finally, all those remaining alive return on the "Victor" to Earth, landing in the Caspian Sea near the city of Lenkorani.

CONCLUSIONS CONCERNING KRASNOGORSKII'S PROJECT

The author expresses a number of interesting ideas that, unfortunately, are not feasible for the time being.

1. The force of radiation pressure of the Sun is taken to be very large and is unconfirmed by experiment.
2. An alloy similar to maxwellium, from which the vehicle is constructed, has not yet been discovered.
3. The successful fall of the wagon to Earth is extremely unlikely.
4. Devices like those described, such as the oxyhydrogen unit of such small weight and the velocimeter, have not yet been invented.
5. The question of navigation in outer space is hardly treated.
6. It is not clear how the vehicle takes off the platform during ascent in the Earth's atmosphere.

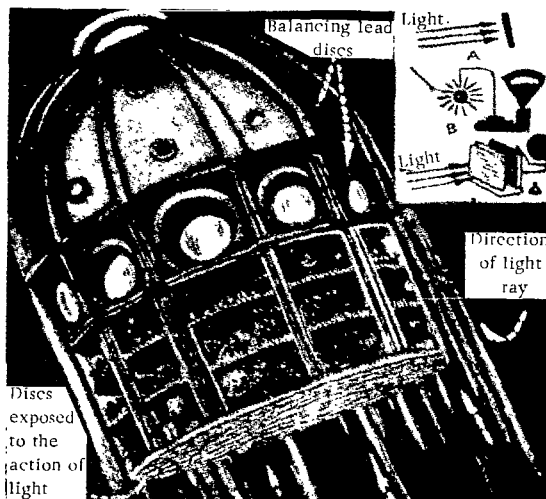

FIGURE 61. Spacecraft driven by radiation pressure

If, as the author says, the beams of the platform are just slightly longer than the mirror, and the balloons are attached to these beams by long chains, these chains and the balloons would interfere with the takeoff of the ship. For this reason, in our sketch, Figure 60, these beams are long enough for the mirror to slip through the chains. But even so, the weight of the whole platform would increase markedly.

Undoubtedly, a similar project (Figure 61) which appeared in a Russian journal in 1924 was inspired by Krasnogorskii's vehicle.

Below the ship there are disks on which the rays of the Sun impinge, imparting forward movement to the vehicle, and higher up on the sides there are additional revolving disks which receive the unilateral pressure of light balancing the vehicle.

CRITICISM OF THE PROJECT OF AN INTERPLANETARY SHIP MOVING BY THE FORCE OF SOLAR RADIATION PRESSURE

Proceeding along the lines that the pressure of light rays on a body's surface should be markedly greater than its force of attraction by the Sun, we find that for the mirror to be carried away by solar rays it should not weigh more than 2 g per sq. m. It is true that gold can be hammered to a thickness of 0.0001 mm, which corresponds to the above weight, but, in the first place, such sheets would not be durable and would be incapable of transmitting light pressure to the projectile with the passengers, and in the second place, they would be transparent to light rays and be unable to receive the required radiation pressure. A mirror with an enormous platform is required to bring the apparatus into movement; for example, in order to lift an apparatus weighing 1 ton from the Earth, a mirror with an area of 2,000 sq. km is needed. In interplanetary space, where weight is absent, the mirror could be much smaller and required only to overcome body inertia and the force of gravity considerably weakened, but its area would still be large.

The first step in this direction was taken by the English scientists Lord Kelvin (William Thomson) in 1871 who expressed the idea that germs of life (seeds, bacteria) of very insignificant weight could be conveyed in outer space in aerolites and reach other celestial bodies, Earth in particular.

In 1873, the Scottish scientist Maxwell, in his theory of light, points out that under the influence of light, minute material particles, which he calls "photospores" and are about 1/100,000th of a cm in diameter, could be carried in outer space.

Three years later, Bartoli demonstrated that not only heat and light rays are capable of exerting pressure but any form of radiant energy.

Further, Professor Ehrenhaft observed that there are substances in outer space that are deflected from their course by the action of light rays; made of such particles, for example, are comet tails that are deflected from the Sun in such a manner that a convex part of the tail face the Sun. The cause of this phenomenon must be sought partly in the relation of the weight of the particles to their surface and partly in their electromagnetic properties by which they are carried through ether.

At the boundary of our atmosphere, solar rays beat with a force of 0.7 mg per sq. m* and this at a distance of about 150 million km from the Sun. Light pressure is governed by the law of action and reaction. Since the Sun emits rays in all directions, it receives a reaction from all sides and as a result equilibrium is achieved.

In addition, enormous prominences are ejected from the Sun and occupy a large part of its surface from which there can no longer be the usual light radiation in outer space; therefore, reaction from the opposite side overbalances and should provide a corresponding movement of the Sun.

The Swedish scientist Svante August Arrhenius theorizes that there are live bacteria in outer space traveling at an inconceivable speed whose weight, in relation to their surface, is so small that the pressure of light is sufficient to move them. This theory indicates a way of obtaining some likely results.



FIGURE 62. Svante August Arrhenius

For a globular particle found near the surface of the Sun with the density of water and a diameter of 1.5 microns, repulsion is equal to attraction and for still smaller particles repulsion may exceed attraction.

Schwarzschild introduced a significant correction to this, pointing out that the relation of radiant energy pressure to attraction reaches its maximum when the diameter of a small globe equals approximately $\lambda/3$, where λ is the wavelength; with further reduction of the globe the relation rapidly decreases.

Further, Arrhenius assumes that because of the action of radiation pressure, small particles concentrated in the solar atmosphere are thrown off by the Sun and wander in space with a speed which may reach a few percent of the speed of light. In the stars, whose radiation exceeds that of the Sun, the speed of these tiny particles may be markedly greater but it never achieves the speed of light. Thanks to the secular repulsion of the small particles, stars have constantly interchanged material, whereby the colder stars have won at the expense of the warmer. It is not inconceivable that the meteorites coming to us at times are composed of such repelled particles. Radiation pressure may also disseminate the seeds of life in outer space. Indeed, the theories that life on Earth originated in outer space are many; we find them in Northern sagas, in the stories of the many gods and human couples transplanted to Earth from the groves of the fountain of Mima (corresponding to outer space).

The possibility of living beings carried from one planet to the others found in the remote solar system with the help of radiation pressure is based on the fact that in outer space, beyond the boundary of the solar system, there prevails a low temperature which markedly slows down life processes and therefore life can be preserved for millions of years.

* Langley accepts this pressure equal to 0.5 mg per m². Tsiolkovskii considers that 1 kg of substance in one year under the influence of light pressure obtains an increase in speed of more than 200 m/sec.

Svante August Arrhenius (Figure 62) is one of the most remarkable naturalists of our time. His first work, presented on graduation from the University of Uppsala (1883), dealt with the problem of electrical conductivity of solutions of electrolytes—substances whose solutions conduct a current. The theory developed in the foregoing work evoked a flurry of objection at the start, but it later helped to clarify some of the obscure phenomena observed in solutions.

It soon found universal recognition and is now one of the basic theories of solutions. Research conducted in this field has produced much that is new but the basis laid by Arrhenius has never been shaken.

Like many other great scientists, Arrhenius did not limit his interests to one field. He was broadly and deeply attracted by the world surrounding him and eager to grasp and know it from a purely scientific approach.

His books, "Treatise on Cosmic Rays," "Worlds in the Making," "Der Lebenslauf der Planeten," and "Conception of the Universe through the Ages," are very interesting in content and attractively presented.

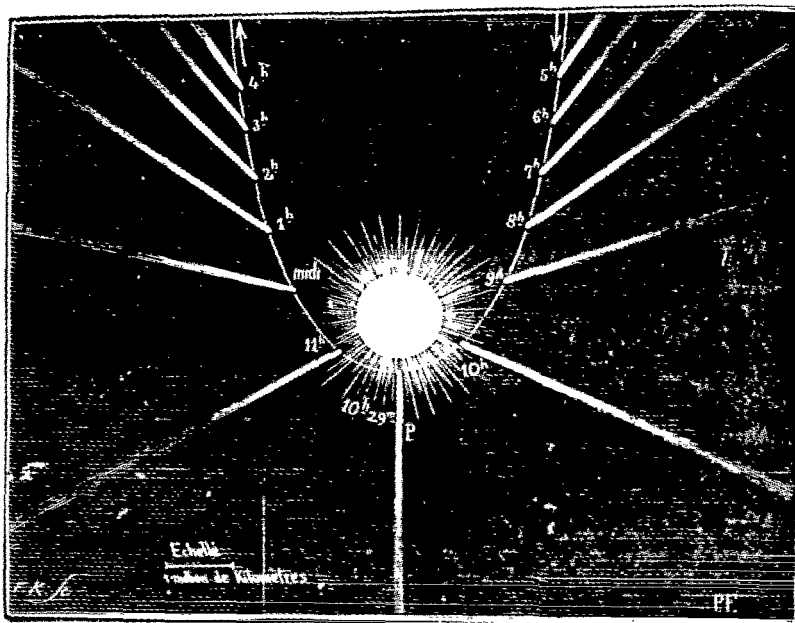

FIGURE 63. Repulsion of a comet's tail by the Sun

One may not agree with many of the suppositions expounded in these books; however, there is no question but that the ideas contained in them are original and witty, and they bear the imprint of a great man.

The French astronomer C. Nordmann apparently also shares the views of Arrhenius. The great thinkers — he writes — starting with Kant all the way up to Lord Kelvin contended that the germs of life were brought to Earth by aerolites flying from some remote world.

But the mechanism of this transmission remains ambiguous. Moreover, until quite recently it was assumed that the perfect vacuum and very low temperature of interstellar space were an insurmountable obstacle to the transportation of living organisms.

However, recent experiments reveal that the vacuum and temperature close to absolute zero (-273° according to the Celsius scale) have a preservative effect, not a destructive one, on many bacteria. The cold and vacuum only paralyze for a long time the vital functions of these minute particles, which live only for a few hours under normal conditions. Later, when they fall into a suitable medium they regain their former vitality.

Does this not resemble the story of the Sleeping Beauty, only this time a true story and one that is transferred to the microscopic level?

Experiments conducted in this connection show that even under such cold conditions (ca. -273°) the vitality of bacteria does not vanish. Thus, at the laboratory of the Jenner Institute in London, bacteria spores subjected to a temperature of -250° for a period of twenty hours preserved their vitality. Professor McFeyder exposed germs to the effect of cold for six months without harm. Becquerel of the Leyden laboratory kept bacteria and spores for three weeks under a temperature of -253° , also without harming them. The question now remaining is, will these germs not perish in

outer space under the influence of ultraviolet and other lethal rays? It would appear that Becquerel's experiments confirm this danger. But one might object that particles moving in space probably are not subject to such a powerful radiation effect as was the case during the experiments. Besides this, it might be that outer space is not an absolute vacuum — nebulae are present and this also diminishes the effect of the rays referred to.

In any event, interstellar space is an environment conducive to the transmission of life. With respect to the question of how *microorganisms* can be transferred from one world to another, the new discoveries on the effect of light will help us to clarify this point. The Sun attracts and holds in its mighty embrace only bodies of considerable mass. When this mass is reduced solar rays repel it. This repulsion is the most probable cause of the deflection of

comet tails (Figure 63). Microscopic objects whose diameter, like that of most bacteria, is a mere ten-thousandth part of a millimeter, are driven by solar light through infinite space, until having blended with cosmic dust they are once again attracted by some terrestrial body. From this point it is not difficult to understand how life at one time could be transmitted from one solar system to another. It is sufficient for a planet to have existed somewhere in the depth of the Universe, near Sirius or even deeper, whose atmosphere could contain such microorganisms as we have, and whose

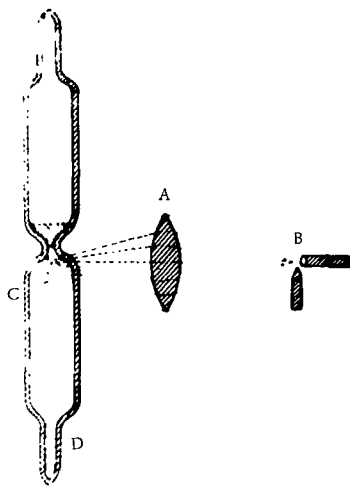

FIGURE 64. Experiment of Nichols and Hull

myriads, driven by the rays of the neighboring Sun, set off, deep in a lethargic slumber, for a faraway journey through icy space.

May we presume that this is how there fell upon the Earth the first germs of life? Indeed we may!

According to the theory of the English astrophysicist Eddington, all the stars radiate as much energy as is released by means of intra-atomic processes. This emitted energy exerts radiation pressure on bodies encountered; this pressure is proportional to the fourth power of the absolute temperature. At the surface temperature of the Sun of $7,000^{\circ}$, its rays beat perpendicularly on 1 sq. m of Earth's surface with the force of 1 milligram.

If the Sun's temperature were to increase to 7 million degrees, the pressure of its rays on a square meter of Earth's surface would increase by $1,000^4$ times and would equal a million kilograms per m^2 . This quantity of radiation pressure is attained at the center of the Sun and other stars. However, rays of such force are absorbed by the outer layers of the stars and the Sun and we receive only a small part of their energy. However, apart from the visible rays, the least absorbable X-rays can penetrate through the outer atmosphere. The presence in interstellar space of such "ultra X-rays" is detected on the Earth's surface, especially in the higher layers of the atmosphere by virtue of the induced ionization of the air which rapidly increases at altitude and remains the same night and day. It consists of negative electrons detached from atmospheric atoms. In view of the weak intensity of radiation, the number of ionized atoms is relatively negligible.

EXPERIMENTS BY P. N. LEBEDEV, NICHOLS AND HULL

Maxwell's electromagnetic theory of radiant energy invites the conclusion that the surface of a body on which a flux of radiant energy falls experiences some pressure from the latter. In 1883, Bartoli also came to the same conclusion. It is interesting to note that as far back as 1619 Kepler spoke of light pressure and used it to explain the origin of comet tails turned away from the Sun.

His ideas were supported by Longomontanus (1622) and Euler (1746). In 1892, Professor P. N. Lebedev, in a series of skillful experiments, not only demonstrated the existence of radiation pressure but also measured its quantity. On the basis of these experiments, the following results were obtained: assuming that on 1 sq. cm of a surface normal to solar rays and located outside the boundaries of the atmosphere there falls in 1 minute a quantity of radiant energy equal to 3 calories or 126 megaergs, we find that the pressure on 1 sq. m of black (nonreflective) surface will be $\frac{2}{3}$ of a dyne. For an absolutely reflective surface, this pressure is twice as great. If part of the energy passes through the body, it must be subtracted from this quantity as not causing pressure.

For half of the globe illuminated by the Sun this pressure is equal to about 65,000 tons. The force of radiation pressure repels the body from the Sun, whereas the force of solar gravitation attracts it. The first depends on body surface and the second on body mass (volume). With the decrease

of body dimensions, the volume decreases more rapidly (proportionately to the cube of linear dimensions) than its surface, which decreases proportionately to the square of linear measurements; for bodies of very small dimensions it might turn out to be that the radiation pressure will be greater than the gravitational attraction and the particle will fly from the Sun, and the farther, the more rapidly — up to 8,000 km/sec. It should be noted that if the dimensions of the particle are small in comparison with the wavelength of light (for example, around 0.0001 mm), the preponderance of pressure over attraction will diminish. Experiments were conducted on the repulsive influence of light rays; particles of calcined clubmoss seed around 0.002 mm in diameter were deflected markedly by the effect of light in falling in the vacuum.

The American physicists Nichols and Hull conducted the following experiment in 1901, proving the presence of radiation pressure: a glass tube from which the air had been pumped out was filled with a mixture of emery dust and very minute and light calcined fungus spores about 0.002 mm in diameter (Figure 64). This mixture was poured over the narrow part of the tube from one section to the other and on the way was subjected to the action of powerful rays of light condensed by lens A and proceeding from voltaic arc B. Under the influence of these rays, the lighter spores flew to the opposite wall C while the heavier emery dust fell down to D.

Besides light, other forms of radiant energy may produce pressure. For example, an electrical field of strength of 200 volts/m can overcome the force of gravity on a particle 0.00016 mm in diameter.

LE FAURE AND GRAFFIGNY'S INTERPLANETARY SHIP PROPELLED BY RADIATION ATTRACTION OF THE SUN

The French authors Le Faure and Graffigny in their book "Aventures extraordinaires d'un savant russe" (Paris, 1889) describe an interplanetary ship whose structure and principles of flight are the contrary of the preceding and consist of the following:

The vehicle, which has the form of an artillery shell, is covered outside with a special compound found on the Moon which is attracted by the rays of the Sun. In addition, a broad platform composed of 24 parts is arranged around the vehicle. Each part can turn around a special axis fitted into the wall of the craft. One surface of the platform is covered with the above-mentioned compound and the other is blackened. By turning alternately the two sides of the platform segments to the Sun, the direction can be changed so as not to fall directly toward the Sun but to fly to Mercury and Venus. A speed of 20 km/sec is estimated.

Chapter V

THE USE OF RADIANT ENERGY

"Never say 'never'".
Russian proverb

In this chapter are described the projects of writers who have used the "vibrational force of the ether" or "rays of motion" or "solar rays" and other as yet unknown rays to propel their ships into outer space.

V. KRYZHANOVSKAYA'S INTERPLANETARY SHIP

In her two novels "Zakonodateli" ["The Legislators"] and "Smert' Planety" ["Death of a Planet"], V. I. Kryzhanovskaya tells of a ship used to transport the "great initiates" and some of Earth's inhabitants to another planet after the destruction of the Earth.

These vehicles were constructed in the Himalayas. Here is how she describes these craft:

"In the middle of the snow-white summit could be seen a long object which shone like cut-glass in the pale light of the Moon.

"Nearby stood a colossal aerial ship, oblong in shape, made of some strange, transparent, crystalline, phosphorescent substance. At the end of the vehicle was found the only entrance. The interior consisted of three rooms and many small but comfortable cabins of great splendor. The windows of the cabins were made of the same substance as the ship but were very thin; they were covered by curtains made of an elastic material, but opaque like leather.

"These vehicles were propelled by the vibrational force of the ether. This force can decompose and unite atoms of matter. All matter is composed of particles in continuous movement and subject to active forces among which the most visible and rapidly effective is heat; but the ether current guided by conscious will is still more powerful and refined. The internal movement of any type of mass makes it susceptible to thought directed at it by man when it is accompanied by the powerful force of the ether current. Matter is easily controlled by this force.

"The generator of the ether current was composed of two parts, which were as follows: the first part was a metal pipe, hollow inside, with a handle and numerous keys and springs; the pipe was furnished with a mechanism for shortening and extending its length.

"The keys made it possible to determine the intensity and direction of the force.

"The second part was a hollow ring hanging on a small hook; inside the ring were 18 resonators, and on the surface could be seen needles or vibrating rods arranged circularly and downwards on three outer resonators united by metallic threads. In the middle there was another hollow ring, a drum, so to speak, with two rows of circular pipes arranged like the pipes in an organ. In the very center of the second ring there was a rotating disk and in the lower part a small hollow sphere from which came the conductors of force.

"When the generator was functioning, the disk rotated with incredible speed and the force of the motor was unlimited.

"The interplanetary vehicles mentioned above were equipped with engines that, being polarized according to need, could carry enormous loads, ascend easily and fly in any direction under the influence of the ether current.

"The people of the long-lost Atlantis knew how to obtain this force, they called it 'Mash-Ma. '"

"The mysterious Indian books also speak of a vibrational force; in the teachings contained in Atharva-Veda, it is said that a machine driven by this force, when placed in a 'flying ship' and directed at the army, transformed people and elephants into a pile of ashes as it would a stack of hay. In another ancient Indian book of Vishnu-Puran, the same etheral force is referred to in allegorical form, unintelligible to the layman, as the 'glance of Kapilla,' the sage, which transformed Emperor Sagar's sixty thousand sons into dust.

"However, he who mastered this secret could cause such unheard of disaster that the people became more cautious. The use of this dangerous force, enveloped in a threefold cover of secrecy, was concealed behind impenetrable symbols and was entrusted only to the highest initiates. However, as strange as it may appear, in the second half of the 19th century one man discovered the ether force and devised some very clever devices to exploit some of its properties, but. . . it led to nothing. This man was John Kelley. No one helped him. He was ridiculed and, driven to the extreme, he destroyed most of his apparatus and his discoveries sank into oblivion."

AERIAL SHIP OF THE MARTIANS AND THE "EIGHTH RAY OF BARSUM"

Edgar Rice Burroughs in his "John Carter of Mars" describes the adventures of Captain John Carter, who in an occult manner was transported to Mars. There, among other things, he familiarized himself with the structure of the flying vehicles which were used by the inhabitants of the country, Barsum, into which he fell. The body of the vehicle, meant for one man, was 60 feet long, 2 feet wide and 3 inches thick. It was pointed at both ends. The flyer sat at the top of the flat airplane on a seat under which could be found a small noiseless radio-machine propelling the apparatus into motion.

Inside the slender metallic walls of the body was contained the "eighth ray of Barsum" or "ray of motion," as it could be called in view of its characteristics.

This ray, like the ninth ray, is unknown to us on Earth. The Martians discovered that it is a component of any light, irrespective of its source. They learned that because of the force of the eighth ray, the Sun's light reaches different planets and that the eighth ray of each planet in turn reflects the light back into space. The solar eighth ray would have been absorbed by the surface of Barsum, but the eighth ray of Barsum is continuously emitted from the planet and thus forms a repulsive force. If this force were to be concentrated it would be capable of lifting an enormous load off the surface of the soil. The Martians could bring the art of airships to perfection solely on account of this eighth ray. Their warships, in many ways outstripping the dirigibles on Earth, sailed through the rarefied air of Barsum just as easily and graciously as toy balloons in the dense air of the Earth.

"In the first years after the discovery of this ray, many strange and even tragic events occurred before the Martians learned how to regulate the marvelous force discovered by them. Thus, 900 years ago the first large warship was loaded with an excessive supply of the eighth ray. The ship rose from the capital with five hundred passengers and never returned: its repulsive force was so great that it was carried off into space. It may be seen to this very day through a telescope. It floats in space at a distance of 10,000 miles from Mars — a small satellite which will revolve around Mars until the end of time."

AREL'SKII'S INTERPLANETARY SHIP

G. Arel'skii in his book "Povesti o Marse" ["Martian Stories"] describes the structure of an interplanetary ship ("aerobile") in which the Martians travel to the Earth.

The aerobile was built on the principle of a planet. Like a planet, it was surrounded by an atmosphere formed from a specially processed gas inside the apparatus. This gas casing protected the craft from the cold of airless space and resolved all previously unsolved difficulties. The ship took energy from solar rays.

After the first successful experiments of flights to Earth, an institute called "Interplancom" (interplanetary communication) was opened and a "Society of Solar Engines" was organized. Regular communications between Earth and Mars were established on these ships.

SOLAR ENERGY FOR FLIGHT ACCORDING TO GONCHAROV

V. Goncharov in his science fiction story "Psikhomashina" ["Psycho-Machine"] (1924) writes of the instruments built by Moon dwellers to concentrate and accumulate the energy of solar rays. Solar light passing through

a number of glass lenses falls into special transparent vats where it is pressed, condensed and then poured into cylinders. The lunar flying craft is charged with these cylinders. Light energy turns the propeller and moves the wings of the vehicle.

REPLENISHMENT OF ENERGY STORES, ACCORDING TO OBERTH, IN FLIGHT OF AN INTERPLANETARY SHIP

Professor Oberth considers that with the passing of time it will be possible to collect solar energy and produce electrical energy from it with the help of parabolic mirrors in the rocket ship. Further, he contends that phenomena in cathode-ray tubes could be utilized in interplanetary ships.

EXPLOSION — A SOURCE OF ENERGY ACCORDING TO UL'YANSKII

In the journal "Mir Prikl'yucheni" (No. 3, 1925), there appeared a short science fiction story by A. Ul'yanskii, entitled "Koleso" ["Wheel"] which is about a scientist who invents a wheel that rolls across the Earth demolishing all obstacles; the wheel is driven by the force of explosions of a special substance "helidium" discovered by him. This substance possesses a tremendous explosive force; the waste materials thrown off by the explosion again feed the basic substance and restore its force. With each new explosion the force of the substance increases. All elements encountered in nature — earth, fire, water — in combination with the substance of the wheel only strengthen it. The wheel can stop only when for some reason it re-traces its own tracks. Passing around the Earth several times the wheel causes heavy destruction. A committee is set up to prevent this and finally succeeds in getting it back on its old track; its energy becomes feebler and finally runs out.

V. ORLOVSKII'S "REVOLT OF THE ATOMS"

A similar idea to the preceding automatic increase of destructive energy and then its cancelation can be found in V. Orlovskii's novel "Bunt atomov" ["Revolt of the Atoms"] ("Mir Prikl'yucheni", "No. 3, 1927).

The plot is as follows: Professor Flidner in Berlin discovers a way to explode atoms and conducts such an experiment. However, the decomposed atoms start to influence others, decomposing them and radiating more and more energy. Flidner is unable to stop the process of decomposition of greater and greater numbers of atoms. It appears as if there is a "revolt of the atoms." Gradually a ball lightning begins to build up, destroying everything in its way and increasing in dimension. Traveling through Earth, the ball lays wide devastation. Scientists of the whole world gather to

save humanity. Finally, one engineer succeeds in constructing a tank that sends electromagnetic waves designed to synthesize the atoms in the destructive nucleus and by this means to halt its destructive action. As it happens, at the moment of encounter, in Italy, of this tank and the nucleus, the latter falls within the range of a massive eruption of Vesuvius and is borne off to outer space by a vortex from the crater of the volcano. *

- A similar idea of an "atomic fire" is proposed by Hans Dominik in his book "Das Erbe der Uraniden."

Chapter VI

ELECTRIC SHIPS

"Man cannot contrive the unrealizable."

The next type of space vehicle described in fiction is an electric craft. The energy required to make it fly is derived from electricity. The novels do not give the specific details of the engine structure. More often than not, it remains "fantasy" with hints thrown at its existence but the material source or mode of obtaining this electricity remains for the time being unavailable to the ordinary mortal.

V. I. KRYZHANOVSKAYA'S INTERPLANETARY SHIP NO. 1

The writer V. I. Kryzhanovskaya in her novel "V inom mire" ["In Another World"] (1917) gives the following description of an interplanetary ship flying from Venus to Earth and back.

Arrival of the ship on Earth. — "Psyche (heroine of the novel) lay on the pillows on the high platform of the tower (Alexandria in Egypt) and a feeling of weakness and unusual lightness pervaded her whole body; this feeling was so distinct that it seemed to her that the first gust of wind would carry her away.

"Her attention was caught by Ali (an Arab occultist), who was standing in the center of the platform (D, Figure 65) near a strange object. From the middle of a large, circular, black stone (C) protruded a metal cone (B) on the top of which burned a huge blue flame, spluttering and rapidly revolving.

"Look," said the Arab, pointing a finger to a bright dot in the sky which from the depth of space was flying directly towards them at incredible speed and rapidly becoming larger. Psyche thought it was a falling star but soon saw that it was an

immense, nebulous and phosphorescent sphere (A).

"Arriving at the tower the sphere started to circle the flame and then stopped at the summit of the metal cone, as if fusing with it. At that

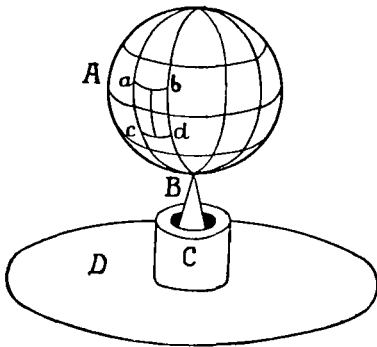

FIGURE 65. Kryzhanovskaya's interplanetary ship No. 1

moment, from an opening (abcd) in one side of the sphere, a tall man (Remfa) wrapped in a speckled coat, resembling spangles, sprang to the platform two steps away from Psyche. . . "

Departure of the ship to Venus. — ". . . Again she felt as if she had become weightless and was spinning in the air, clutching her veil; and then she found herself in an atmosphere impregnated with a special invigorating air.

"Her head spun and she closed her eyes; when she opened them again she saw that she was inside the blue sphere which she had seen arriving. The transparent, crystalline sphere flew swiftly, gyrating with deafening noise. her thoughts became confused and she lost consciousness. "

Arrival on Venus. — "Regaining consciousness, Psyche felt as though she were in a fiery whirlwind rotating so violently that she could think and breathe only with difficulty; then came a powerful jolt, as if the sphere had smashed to pieces, and she found herself on firm soil. The heaviness and torpidity vanished as if by magic. . . . "

Departure from Venus. — "In the window, thrown wide open, appeared a whitish, phosphorescent sphere, similar to the one which had brought Psyche here. In the opening surrounded by a nebulous mass stood Atoim (Remfa's helper). . . .

"Remfa lifted Psyche and placed her in the arms of Atoim. The door closed and of what happened after that Psyche was not aware. "

Apparently, the author's thoughts were such: before the flight the traveler lightens the weight of his body by a special process and becomes electrified. The envelope of the ship-sphere is composed of condensed electricity (like ball lightning). The movement of the sphere in space is directed by an electrical machine (cylinder C and cone B with blue revolving flame). The electric currents with which the body of the pilot is saturated and with which he can, if he so desires, act on the stations of departure and arrival also help to steer the vehicle. The door in the sphere is also electrical and opens as the pilot wishes. The movement of the sphere is subject to the laws of electrostatic attraction and repulsion.

V. I. KRYZHANOVSKAYA'S INTERPLANETARY SHIP NO. 2

In her novel "Na sosednei planete" ["On a Neighboring Planet"] (1903), Kryzhanovskaya tells of a voyage from Earth to Mars in a special vehicle, various views of which are shown in Figure 66. In the vehicle were two people — the Magus Atarva, the pilot, and his pupil, Ardea, the passenger. Before the takeoff they had lightened the weight of their bodies by a special process; in addition, Ardea had sunk into slumber.

The vehicle itself (I and II) was cigar-shaped, one end terminating in a revolving wheel (7) like those used over lamps to collect the soot. Its surface glittered, since it was made of metal. Four openings had been cut out of the walls at both sides and framed with thick glass (8): two were in the middle and two at the opposite end to the wheel. At the top (9) there was

a door which looked like a lid and it was through this opening that Atarva carried Ardea inside and placed him on the cot (1).

Inside, transparent globes (6) containing a substance resembling sponge were hung on the walls. Each globe had an exit controlled by a special device.

At the other end of the vehicle there were seats of soft pillows (2) near two windows, and in front of the seats there was the electric motor (4) with a movable steering wheel (3) like that on a bicycle. In front of the vehicle was a projector (5).

The departure occurred thus. The vehicle was lifted off the elevated platform by a balloon (III) to a known altitude. Atarva kept his gaze steadily on the quadrant hanging beside him, along which the needle ran rapidly. Suddenly, from the electrical apparatus there burst a jet of flame. The projector flared with a blinding light, scattering a shower of blue rays. The rope holding the balloon was torn as if cut by a razor and the balloon rapidly disappeared into the darkness. Left to its own devices, the missile swayed momentarily while the projector light rapidly changed shade, moving through all the colors of the prism, and ending as a blinding white. Finally, the vehicle set itself in a definite direction and moved forward with astonishing speed, as if it were a falling star, and vanished into space.

"During this night, terrestrial astronomers observing Mars recorded that an enormous column of electric light had burst on the planet and, tracing a fiery zigzag along its surface, had lasted for several hours. Was this a lighthouse guiding the vehicle, or was it a point of attraction that had drawn the vehicle to itself?

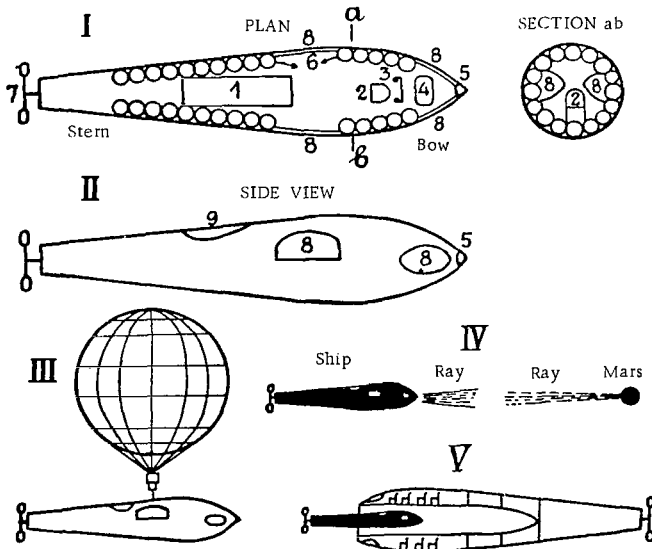

FIGURE 66. Kryzhanovskaya's interplanetary ship No. 2

Atarva's view on the method of flight. — "There is no absolute vacuum. The vibrations, carrying the rays of light from the most remote stars, unite all worlds. The vibrational waves are the best vehicle for those who know how to use them."

Flight and arrival on Mars. — "Borne by vibrational waves the missile flew forward with ever-increasing speed. The projector at its bow gleamed like a bright white star; the rear wheel revolved furiously, emitting a shower of sparks.

"At last a mass of whitish clouds appeared and as it approached it grew to colossal dimensions. The vehicle was grasped in the embrace of a powerful stream and, amidst howling and crackling, placed on a course through a new atmosphere which appeared to thicken and retard its flight.

"Suddenly, in this sea of vapor there appeared a large, greenish star, which drifted towards the terrestrial vehicle. Soon, a huge, long tubular form, similar to the craft flown by Atarva, but three times as wide and long, could be seen; it emitted broad electrical beams like oars. A powerful light beam was directed at Atarva's vehicle. When the two vehicles, rushing towards each other with incredible speed, were at a distance from each other of not more than one second, the front part of the huge craft quickly dropped open. The light on the terrestrial missile was immediately extinguished and, like a lizard, it slipped into the oncoming huge craft (V). The latter turned around and shot back like an arrow.

"Little by little the flight started to slow down. Then the vehicle entered a narrow and dark tunnel-like corridor and, finally, came to a huge room covered by a transparent cupola. In this room the vehicle stopped at a platform especially built for it. A powerful current tore out from the apparatus, roared under the arch of the tunnel, and then everything was silent."

Judging from the above description, one might assume that the vehicle was propelled by the force of the electric current released by the Martians to Earth (IV). When Atarva's vehicle, after takeoff, entered the path of these rays, the rear wheel — their receiver — started to rotate. The globes with the spongy mass were charged with the same electricity and the vehicle was able to be carried to Mars by the force of attraction, which increased the closer the craft came to Mars.

L. B. AFANAS'EV'S ELECTRICAL INTERPLANETARY SHIP

L. B. Afanas'ev in his science fiction tale "Puteshestvie na Mars" ["Journey to Mars"] describes the flight of five men from Earth to Mars and back, and also the structure of their vehicle (Figure 67).

The vehicle was made of metal in the shape of a cone. On Earth or on Mars it sat on a special platform with electrical motors. The vehicle itself was 3-floored. The walls were very thick and made up of several partitions between which there was water to resist the initial jolt. A spiral staircase reaching nearly to the very summit of the cone ran along one side of the ship. The first floor was set aside for supplies of food and water, materials for the production of artificial air (2), the absorption of carbon dioxide (3),

and for storage of other articles necessary for the journey. Nearly the entire floor was taken up by soft-walled closets constructed to protect the objects in these from the initial jolt. The entire ship was lined inside with an elastic sheeting for the same purpose. On this floor could be found different instruments and machines (1 and 4) and also a tank for absorbing various impurities.

The second floor consisted of a large common room, and the upper floor was divided into four quadrants, each of which formed a separate room. These rooms accommodated the five passengers of the ship.

The vehicle was called "Galileo." The common room on the second floor had elliptic windows. A circular entry was found below.

Departure from Earth (from London). — "The pilot pushed a button. The electrical motors sprang into action. A tremor passed through the 'Galileo' and the passengers were thrown upwards. However, everything went off satisfactorily and the soft walls spared them from injury. All this had occurred so quietly and so unobtrusively that it was thought the necessary impulse had not been given to the projectile. The pilot dashed to a window and frantically started to unscrew the bolts that locked it. In a moment the inner layer fell. Then he pressed the electrical spring and the outer layer fell, disclosing an elliptical window made of thick crystal."

Arrival on Mars. — "As they approached Mars, the electrical motors slowed down movement of the vehicle. On entering Mars' atmosphere, the pilot turned off the current. The 'Galileo' shuddered violently and then a light crash was heard; one of the windows in the common room had not endured the jolt and had broken. Fortunately, the wind blowing through the window was a gentle one. The 'Galileo' descended quietly and suddenly bounced, threw its passengers upward, turned over on its side and lay still. The flight took 206 days in all."

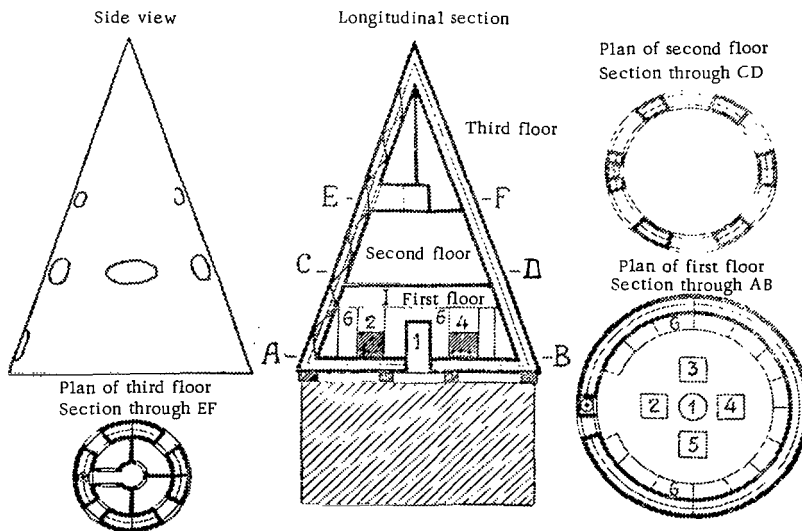

FIGURE 67. Afanas'ev's interplanetary ship

Departure from Mars. — "With the help of the Martians, the lower electrical mechanism, which had remained on Earth during takeoff, was constructed. The cone was placed over this mechanism. At the indicated moment the pilot pressed the button of the motor, the 'Galileo' shook and all the passengers fell from the jolt. The vehicle separated from Mars and rushed in the direction of Earth."

Arrival on Earth. — "Seven months later, the 'Galileo' quietly descended to Earth, on the banks of the Amur River near the city of Blagoveshchensk."

Although the author gives practically no indication of the method for launching the vehicle from Earth and decelerating it while landing on Mars, one may assume that this purpose was served by the repulsive or attractive force of electricity generated in the engine compartment of the vehicle. In the mechanism remaining on Earth, something in the nature of an electrical gun was probably constructed which reinforced the first impulse and immediately provided greater speed.

THE APERGETIC INTERPLANETARY SHIP OF JOHN ASTOR

Around 1900 there appeared in St. Petersburg the translation of the English novel by John Jacob Astor, "Journey in Other Worlds" (a novel of the future). In this work the author describes the journey of three scientists, Dr. Cortland, Society President Beerwarden, and Hero, from Earth to Jupiter and Saturn and back in the year 2000. The movement of the vehicle in outer space is based on the characteristics of a method invented by the travelers for pushing off from planets.

Here is how the author describes the method:

Principle of flight. — "Isn't it strange," remarked Dr. Cortland, "that although it was known a whole century ago that bodies charged with different electricities — positive and negative — attract each other and those charged with the same electricity repel each other, no one has thought of using this?"

"Wait, I've got it," cried Hero. "We could build an airproof projectile, hermetically seal ourselves in it and launch it so that it would be repelled by the Earth's magnetism; then it would recoil from it with the same force or with a force which surpasses the attraction of the Earth. I think that the Earth bears the same relation to space as individual particles to any solid, liquid or gaseous substance; just as particles strive to separate under the effect of heat, so too the Earth will repel the missile if electricity, which is nothing more than another form of heat, is properly applied. This can and must be done by apergy. In nature we come across a system of balancing of forces everywhere. The centripetal force balances the centrifugal force. In apergy we have the counterbalance to gravity, a counterbalance that must exist, otherwise the system of balancing of forces in nature would be disrupted. If the apergy is capable of destroying gravity, then I don't see why it cannot do more; in order to destroy gravity, the repulsion of the Earth produced by apergy should be as great as the force of gravity, and then it would be possible to fly above the Earth in the air surrounding it. But after the apergetic repulsion is carried to the extent that the body does not fall, any increase of apergy will actually make the body rise. From

experiments with electromagnets we see that attraction and repulsion have no limits. This renders us a great service, for if the missile were able to move away from Earth with the same increasing speed as that with which it falls to Earth, it would need too much time to reach the next planet; but since the greatest force of repulsion will be at the very beginning, at a close distance to the Earth (indeed, apery, as a counterbalance to gravity, is also subject to the laws of Newton and Kepler), it follows that the speed of the body charged with apery will be the highest at the beginning. This initial speed must be increased in order to reach the next planet more quickly. Two inclined surfaces may have the same extension, but the ball will run off faster from the surface that is steeper near the top. If we triple or quadruple the charge of apery, the speed of the vehicle will surpass the speed of a missile fired from a long-range weapon. When we fly away from Earth, the attraction by Mars and Jupiter will increase as the repulsion decreases and as there will be no resistance, flight will be faster and faster until the necessity arises to reduce the attraction in order to avoid the danger of smashing into pieces or burning up, like a falling star, from the friction in passing through Jupiter's atmosphere. Naturally, you must be careful to avoid collision with meteorites and asteroids, but if this does happen they may be of use to you, for by attracting or repelling them you will be able to change your course according to need.

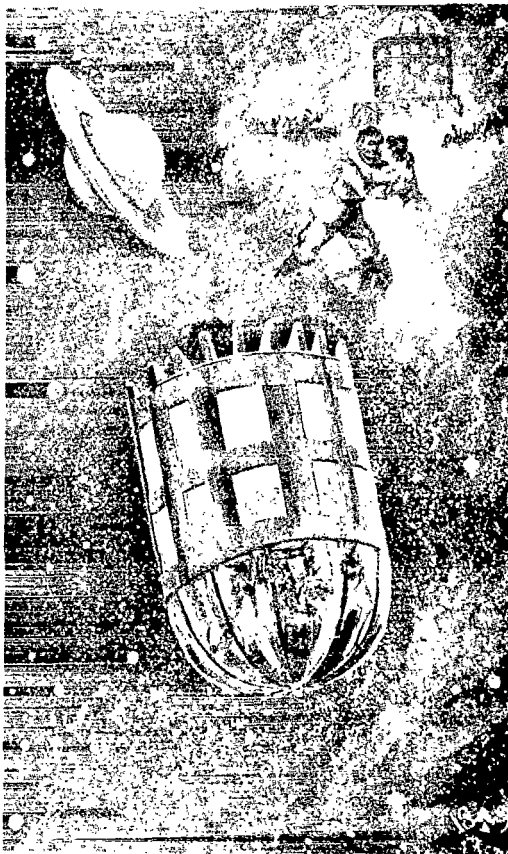

FIGURE 68. Astor's apergetic interplanetary ship

"With apery it is just as necessary to have a heavy body at a given distance in order to act with its help as it is for a ship's screw to have water around it. It is still unknown if gravity is destroyed at the time the apery develops or if it acts in a reverse manner like the attraction of a magnet when the current is changed or, finally, if it is merely overcome by apery where, in the latter case, the movement would be the result of equally powerful apery and gravity."

Structure of the vehicle (Figure 68). The interplanetary ship had the appearance of a short truncated cylinder, 25 feet in diameter; the height of its straight part was 15 feet, and its full height was 21 feet. Outside there was a small gutter to catch the rain on Jupiter and Saturn. The walls, roof and floor were double; each wall was $\frac{1}{2}$ inch from another. The framework was beryllium. The space between the walls was filled with glass fibers for protection from the cold. Broad sheets of plate glass made up the roof and side and smaller sheets the floor; all were provided with shutters and curtains.

Inside the vehicle there were two floors, $6\frac{1}{2}$ feet and $7\frac{1}{2}$ feet high, and a small observation tower in the dome. The floor was grilled like the engine compartment of a steamer to prevent interference with observation when the carpet was removed. The broad, flat foundation and low center of gravity were an advantage in the face of the powerful winds blowing on Jupiter. The vehicle was called "Callisto," in honor of Jupiter's first satellite, whose orbit the travelers were to traverse.

The departure from Earth took place on December 21, 2000 at 11 a. m. from New York. Hero pressed the switch connected to the throttle valve of the machine and the motor started to work with increasing speed. The "Callisto" slowly took off.

Flight to Jupiter. Jupiter, at the time of opposition, was 533 million km from Earth. Light traveling at a speed of 300,000 km/sec needs around 30 minutes to reach Earth from there. If we allow that the average speed of the vehicle is $1/500$ parts of that speed, then around $10\frac{1}{2}$ days will be needed for this flight. En route Mars and the asteroids will be seen, and 1,640,000 km from Jupiter the vehicle will traverse the orbit of Callisto, its fourth satellite.

After the start, the "Callisto" gradually built up speed. The travelers hermetically sealed the window to keep the air in. The ship continued upwards with a speed already at the rate of flight of a cannon ball. Since the takeoff occurred during the day, i. e., from the side of Earth facing the Sun, the travelers were unable to set course directly for Jupiter and were forced to fly a few hundred kilometers in the direction of the Sun and then change course along a tangent to the Earth; only after this had been accomplished could they set the proper direction carrying them past the Moon, since it was imperative that they find themselves comparatively close to such a cosmic body in order to bring the apery into action. The greatest force was exerted and the missile flew from Earth with frightening and ever-increasing speed along the shortest course, i. e., along a straight line, insofar as it was not necessary to adjust it. As long as they did not leave the boundaries of the atmosphere they maintained the greatest apery repulsing force, concentrated in the upper part of the cylinder, so that this point went forward and they met with the least resistance. Soon they reached airless space and then started to change course to a spiral trajectory,

charging the "Callisto" with apery and directing the current to the Moon, thus assisting lunar attraction, at the same time not ceasing repulsion by the Earth; movement of the vehicle was eventually guided by the resultant of the two forces.

Although the Moon and "Callisto" were moving in lines converging at a point, the speed of the vehicle was so great that they were carried along without touching the Moon. In the effort to change their flight direction with the help of the Moon's attraction they cut the action of the force driving them from Earth and immediately the "Callisto" turned its heavy bottom towards the Moon. They were now flying so rapidly that the speed alone would have sufficed to carry them hundreds of thousands of kilometers into celestial space; at this time they were traveling nearly side by side with the Moon at a distance of a few thousand kilometers.

When the dark side of the Moon was turned to them and the effect of the Moon's attraction on the missile gradually started to be detected, they again resorted to apery force and, pushing away from Earth and the Moon simultaneously, they set course directly for Jupiter with a speed of around $1\frac{1}{2}$ million kilometers per hour. Maintaining the course for Jupiter but not according to the position it would occupy in 10 days, they knew that they would fly past it because the gigantic planet, being in rapid movement, would leave them behind; however, they were not averse to this since they wanted to observe it from one side. If they were desirous of landing on it they could change course with the help of its satellites, of which the fourth, their namesake, should prove of the greatest service.

During the flight they encountered a stream of asteroids making up the head of a comet. Whenever large boulders threatened the glass they applied the apery current and thrust them off. In such cases, the "Callisto" recoiled slightly; the movement of each of these bodies was in inverse proportion to its weight.

Emerging from the boundaries of the comet, they applied the repulsive force to its head and when they were at a good distance from it they again cut off the current.

Landing on Jupiter. Finally, they approached Jupiter. Hero turned the handle and reduced the movement. Finding a strip of firm ground between a forest and a cove they carefully landed and emerged from the vehicle.

Departure from Jupiter and landing on Saturn. The travelers applied the maximum force of their battery in order to ascend into outer space. Finding themselves a few thousand kilometers over the pole of Jupiter, they directed part of their force of attraction towards the nearest satellite of Jupiter which helped them to overcome the attraction of the latter; then they used the attraction of the next satellite and finally pushing away from Jupiter with increasing force, they were carried in the direction of Saturn. Eventually, passing through its rings, they rapidly descended to Saturn.

Departure from Saturn and return to Earth. The travelers turned on the current and the "Callisto" started slowly to ascend from Saturn. Their speed rapidly increased. While within the boundaries of the atmosphere, they applied full current and were once again carried in the ether with the speed of a comet while their movement in the direction of the Sun itself was helped by the large solar mass. They rushed swiftly beyond the far edge of the enormous silver rings of Saturn, traversing one orbit after the other of its eight satellites; from the last of these satellites, Iapetus, they received the

final push directing them towards Earth. Without deviating from an almost direct path they came to within a distance of nearly $1\frac{1}{2}$ million kilometers of Jupiter, and a few days later they traversed the orbit of Mars. Since the Earth had completed nearly half its journey in orbit since their departure, they turned slightly to the right, utilizing the attraction of Mars, in order to avoid coming too near the Sun, around which they passed two days later, then directing a course to Earth. Finding themselves at last close to it, they retarded the fall and gradually came down in New York on July 10, 2001, at around noon.

Conclusion. The principle upon which the flight was based — the miraculous apery — is imaginary. It is interesting to note that the driving force is applied to the head of the vehicle, which facilitates the start and landing on planets and prevents the craft from overturning.

THE STRUGGLE AGAINST GRAVITY WITH THE HELP OF ELECTRICITY, ACCORDING TO THIME

In 1926, "Der Flug zur Sonne" (Flight to the Sun) by Paul Thime was published in Germany. In this novel, the author tells of a German who in Germany not only discovers the possibility of reducing the gravity of bodies under the influence of the action of a powerful magnetic field of 2 million gauss, but also the complete elimination of the effect of gravity so that the body hangs in space without material support. Besides this, the author describes new rays acting on the magneto of engines and paralyzing their action. With the help of these discoveries, Germany liberates herself from dependence on the countries victorious in World War I and even acquires domination over them.

Chapter VII

RADIO SHIPS

"Fantasy is not always a delusion; it is often the truth not proven or, at least, not yet proven."

(C. Nordmann. "Journey around the Universe")

The idea of communicating movement to an interplanetary ship with the help of energy sent from Earth by radio has also attracted some writers to whom this idea seemed probable. It appears that N. Rynin was the first to express it in his fantasy "V vozdušnom okeane" ["In the Aerial Ocean"]; the same notion was taken up by A. Tolstoi and R. Yaroslavskii.

YAMATO'S INTERPLANETARY RADIO SHIP

In Rynin's "V vozdušnom okeane," mentioned above, which was published in Moscow in 1924, the plan of the Japanese engineer Yamato to fly to the Moon is described.

The basis of the flight is the principle that bodies charged with like electricity or magnetism repel, and with the opposite, attract.

Further, Yamato considers that Earth is a vast magnet surrounded by zones of magnetic force extending to an enormous altitude. Yamato's ship, at the wish of its pilot, is to be charged with positive or negative electricity or magnetism and, depending on this, to be attracted or repelled by the Earth. Devices of the nature of electric generators are found on the ship. The force bringing them into movement is to be obtained from without, in the form of rays of cosmic energy (Millikan's rays), or is sent from Earth. For this purpose, six powerful radio stations set up on Earth — in Tokyo, Melbourne, London, Cape Town, Denver and Santiago — are to transmit radiowaves to the flying vehicle and in coordination with the pilot to attract or repel the vehicle relative to the Earth and the Moon (Figure 69).

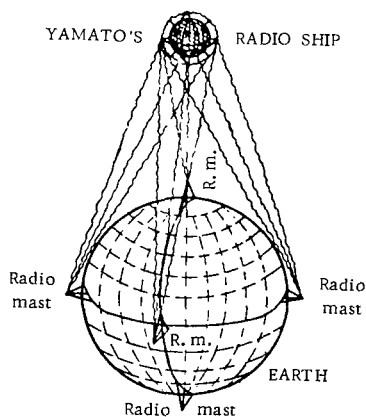

FIGURE 69. Yamato's radio ship

Yamato painstakingly worked out the sidereal (stellar) conditions of navigation.

For example, by rotating the plane of induction of the generators in the vehicle he intends to achieve orientation in space since, in his opinion, the zones of different magnetic strengths around the Earth maintain their position for a long time. By knowing the angle of inclination of the plane of induction to the given zone, the position of the vehicle in relation to the Earth can be determined. Further, Yamato indicates the conditions of existence of passengers in airless space, calculates the duration of the flight and even proposes methods of probing lunar territory for radium with which, in his opinion, the Moon is abundantly supplied and whose value would pay for the cost of the entire expedition.

Details of the project have not yet been published and the solution of the question of flying by this principle is tied up with the question in general of transmission of energy without conductors.

THE MARTIAN AIR SHIP (HELICOPTER SUPPLIED WITH ENERGY BY RADIO)

(By A. Tolstoi)

The writer A. Tolstoi in his novel "Aelita" gives the following description of a Martian air ship:

"The flying ship resembled a three-masted Carthaginian galley. Three pairs of sharp flexible wings stretched from its sides. At the edges of its short masts vertical propellers roared mightily, sustaining it as it hung over the terrain. From the sides ladders were lowered and the vehicle alighted on them. The propellers stopped. During flight the engines worked soundlessly. They were not even visible. It was only at the axis of each vertical propeller that a round casing, similar to the casing of a dynamo, spun around, while at the top of the fore and aft masts two elliptic baskets of silvery wires crackled."

A. YAROSLAVSKII'S INTERPLANETARY RADIO SHIP

In 1926, the Utopian novel "Argonavty vselennoi ["Argonauts of the Universe"] (Moscow-Leningrad, Publ. "Biokosmisty," Penza Press) by A. Yaroslavskii was published. In this work the author describes the journey from Earth to the Moon and back of three persons — two men and a woman — in a rocket ship propelled by the recoil force from the disintegration of radium. Here is how the author describes the principal part of the ship — the source of energy. "A dreadful and immeasurable force was concentrated in a small metallic case like a large and very heavy cigarette case: the push of a lever was enough to discharge from the case one atom of liberated radium, more than enough to blow up a large city."

The hero of the novel Goryanski learned how to disintegrate radium into its component parts and during disintegration of the particles to obtain the necessary explosive force.

The vehicle, named "Victor" (Figure 70), was blunt-nosed (b) and elongated towards the stern (c), where the rocket nozzle and the rudder appeared. In general, it resembled in form a falling droplet. Its windows (a) were made of two pieces of uncut crystal glass.

For landing on the Moon or on Earth there was a second rocket engine producing counter-explosions in the front part of the vehicle.

A radiotelephone and radiotelegraph were on hand for communication with Earth during flight.

For this purpose, on one of the Samoan Islands in the Pacific, where the launching and landing of the "Victor" was planned, nine radio towers were constructed, of which the central one was 750 m high, i. e., $2\frac{1}{2}$ times higher than the Eiffel Tower. Besides the transmission of communications it was also possible with the help of these towers to transmit to the ship quantities of energy, although this would be unprofitable since more than half the energy transmitted is dissipated in outer space. The travelers reach the Moon, find a cave there with air, and in addition a special creature of a higher order provides them with 100 g of radium for their return flight to Earth.

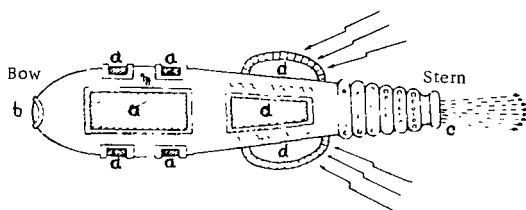

FIGURE 70. Yaroslavskii's interplanetary radio ship

MICHAËLIS' RADIOSPECTRAL INTERPLANETARY SHIP

One of the finest novels dedicated to interplanetary travel is "Himmel-skibet" by the Danish writer Sophus Michaëlis, which was published in Denmark in 1921 and translated into Russian in 1927. The novel fascinates the reader not only by its plot but also by the refinement of style, the brilliant display of color, the wealth of fantasy and the sunny pleasures of life, combined with the cult of beauty. **Plot of the novel.** During World War I the Italian Hercole Sabene is taken unawares in his trench by a stream of poison gas which, in the form of a cloudy boa constrictor, snatches him and he faints. When he comes to, he finds he is in the interplanetary ship "Cosmopolis." The captain of the ship had been flying above the trenches and when Hercole fell, he caught him with his anchor and lifted him into the ship in which there were already twelve persons — deserters and pacifists of different nationalities.

At their head stood the Italian Avanti. The "Cosmopolis" was on its way to Mars. During the journey they fall into a stream of meteorites but happily pass through it. The landing on Mars occurs without incident. On this planet they find a highly developed people outwardly resembling Earth

dwellers. The cult of the plant reigns here. Food is entirely vegetable. Animals feed only on plants. Hercule describes his stay on Mars during one whole summer. Dwellers of Mars, having lived for a fixed time and feeling death approaching, board a large boat and are carried away by a swift water stream to an unknown country from which they never return. Hercule decides to follow this stream. He seats himself in a boat and is carried in the stream amidst cliffs. The eddying of a whirlpool brings a feeling of somnolence. . . . The overhanging cliffs at the sides open up. Will he not be carried away by the current of the waterfall?

The sea must be nearby! In a minute or two the stream will carry him into a boundless ocean never before seen by him. . . .

Powerlessly, he writhed on his crackling bed of leaves until at last he was able to rest his head on the side of the boat and see afar. His presentiments had not deceived him: the stream bore ahead, forming a transparent, glassy wall. The noise of the waterfall nearby resounded in his ears. And the waterfall itself. . . . There, where a gigantic column of water spray trembled in the air. . . .

Suddenly, the channel again narrowed, turning into a ditch. And Hercule recognized the cloud creeping towards him, the boa constrictor coiled into a ring. . . . Swelling, filling up the entire channel. . . . A milky fog clouded his eyes, and he swallowed death like absinthe from a bottomless cup.

In the morning, Hercule Sabene awoke in the trench. The glass eye-pieces of his mask were broken. The poison gas had damaged his lungs. But he lay and smiled sadly, as if he had had a marvelous but sorrowful dream.

Structure of the vehicle. The interplanetary ship "Cosmopolis" was shaped like a globe with a row of spheroidal glass windows which could be closed outside by movable steel shields. Inside it was filled with cabins, passages, halls and an observatory; the numerous compartments converged in raylike form at the center, and could move to all sides around this center. To observe the Sun there was a special observation chamber rotating in line with the movement of Mars along its orbit. For entrance into this chamber it was necessary to don glasses, masks and red netted vests to avoid burns. Under the effect of solar rays, machines in the chamber could purify the polluted air and transform human secretions into food products. The Earth was observed by a telescope from a special terrestrial chamber. Finally, for the goal of the flight — Mars — one chamber with a gigantic telescope was continuously focused on the planet. There were periscopes outside the ship for facilitating observation of the surrounding space.

During walking within the ship the feet were slightly suctioned to the floor.

Principle of flight. This is how one of the passengers, the Austrian Kraft, explains the principle of flight to his companion Hercule:

"Every celestial body possesses its spectrum. Spectral analysis is, so to speak, a specific method of signalization of each individual celestial body. With the help of radium we obtain a special type of stellar spectrum, stronger and brighter than any former spectrum; in the most accurate way

it informs us about the elements of each body, its weight, size, density and cosmic force. Now, such a radio spectrum of Mars is for us both a driving and guiding apparatus. It acts like a suction disk, radiating current in the direction of the planet for which we are heading. By amplifying this current we overcome the Earth's force of gravity. . . In order to get away from Earth we need command a speed of only $11\frac{1}{2}$ km/sec. With the help of the current forming between Mars and its radio spectrum — here under our feet — we can achieve a much greater speed. We are falling through the ether in outer space uninterrupted and unimpeded, as if we were attracted by an invisible thread through the entire Universe. With our radio spectrum and its current we can only land on that planet to which our feet are turned. This radio spectrum also adjusts the position of the telescope which remains directed at Mars all the time. "

"May I see this guiding and driving radio spectrum?" asked Hercule.

"Yes. Lie down flat over here where the transverse line goes. "

"Is that the spectrum of Mars?" asked Hercule, stretching himself out on the floor.

"Wait a minute! Don't be frightened when I turn out the lights. And put these on now. "

"Black glasses? But I won't be able to see anything in them. "

"Put them on and close your eyes until I say, 'Open. '"

It was dark as a tomb. Hercule Sabene shut his eyes and, trembling in tense anticipation, pressed both palms to the glasses.

"Open!" cried Kraft.

Hercule Sabene opened his eyes.

It was as if someone had removed the lid from the illuminated interior of a watch glass. Hercule lay as if he were at the edge of a luminous abyss and glanced down into the magic radiance of spectral bands. He seemed to hover in shadow over the sparkling valley. Fiery colored bands alternated from one hue to the other, forming a quivering sultry cliff; an iridescent bridge of flaming purple, of flowing sulfur yellow, molten aquamarine, dazzling bright green, rainbow after rainbow, blinding, wondrous, mad beauty. . . !

Band after band assaulted and wounded his eyes. Never before had the retina mirrored a similar fantastic, insane delirium of color. . . .

Hercule Sabene was speechless. He was lost in the vision, he had become a pair of painfully dilated eyes hungrily drinking in the brilliant pageant through the dark glasses without which the unprotected eyes would never have endured, but which filled every dark corner of his being.

And, suddenly, he was blinded. The iridescent bridge beneath him disappeared. He swam and then lay on the summit of the cliff, above the abyss of the Universe, plunging his head onto the cold impenetrable floor. The door to the magical tomb of eternity slammed.

Flight from Earth. The author does not describe the takeoff in detail. Apparently it occurred, like the flight, under the influence of the attraction of the radio spectrum of Mars. When the "Cosmopolis" was a few hundred feet from Earth, its crew spied in the light of the projector the unconscious Hercule in the trench. The anchor, dragging along the ground, had accidentally fastened onto the broken gas mask. Hercule was caught by the hook and was lifted into the ship.

The flight of the ship in space consisted of falling toward Mars under the influence of attraction of the radio spectrum. During the journey they were bombarded by a stream of meteorites from which they were saved by the movable steel shields covering all the windows.

The landing on Mars occurred in the following way. To soften the impact of the fall and to prevent the "Cosmopolis" from going up in flames during the swift passage through Mars' atmosphere, Avanti managed gradually to weaken the strength of the current of Mars' radio spectrum. To lower the "heavenly ship," the ordinary force of Mars' attraction was sufficient. However, the weight of the "Cosmopolis" itself could have played a fateful role during the landing if the descent had occurred too abruptly in a vertical line; it became necessary to slide down along an oblique line as airplanes do.

The periscopes provided Avanti with the possibility of viewing two satellites of Mars. They were small and shone weakly. In capturing their spectra through the radio spectroscopes and turning on their current, Avanti relied on using the attraction force of these two satellites to play the role of two balancing wings of an airplane.

Reducing speed in this manner, the "Cosmopolis" continued to approach Mars.

After closing off the spectrum of Mars and moving ahead on the spectra of both moons, as if on soaring wings, the "Cosmopolis" glided in rarefied air. Meanwhile it was reassuring to know that the ship was flying obliquely downward into the quiet, slumbrous atmosphere with the lightness of a soap bubble. Avanti and Kraft, clad in spacesuits, flew out of the globe to test whether the air of Mars was suitable for breathing, and with great joy discovered that it was eminently so.

Finally, when the guiding moons were hidden behind the horizon, they entered the globe, shut the doors and removed the periscopes.

At the moment the last ray of the moon vanished, the "Cosmopolis" landed. The framework of the ship shuddered convulsively and it came to a grinding halt. All its steel and glass parts clattered and its seams groaned. However, nothing untoward happened. The projectile was at a "standstill."

THE DISK-SHAPED SHIP (AVIASTELLA) OF DWELLERS OF A REMOTE NEBULA

A. Volkov, in his short story "Chuzhie" ["Foreigners"] ("Mir Priklyucheni," No. 2, 1928), describes how the inhabitants of a remote nebula fly to Earth and back.

Their home is a spiral nebula in which there is a star cluster and in this cluster there is a double star, one blue and the other orange. Around these star-suns there revolve two planets, the smaller around the orange star, the larger around the blue one. The smaller one is almost wholly covered with high-grassed jungles rising out of water. The larger is the home of the living beings who fly to Earth.

While flying in outer space these beings, "foreigners," as the author calls them, suffer an accident and land on Earth, having called for help from another ship in outer space. Here is how the author describes the structure of this ship.

"From the clouds there emerged a mammoth disk, slowly and silently revolving, which resembled a gramophone record and in dimension was as large as the arena of a big circus.

"In the center of the disk was a hatch set in a broad convex frame of burnished white metal. The immobility of the frame indicated the rotation only of the outer envelope of the ship.

"An elevator cage on two slender cylindrical supports led downward from the hatch and on this one of the 'foreigners' was lifted from Earth. Behind this a large ball of tangled metallic joints could be seen emerging from the hatch; as it descended, it lethargically opened into a huge hand, behind the wrist of which appeared an elbow. Suddenly animated, the hand unfolded and with its metallic fingers seized a package lying on the Earth (Figure 71) and carried it into the ship."

One of the Earth dwellers who by chance had watched this operation decides, with the consent of the "foreigners," to fly with them, promising his comrades remaining on Earth to return in 10—20 years.

On the way the ship "Aviastella" draws to itself like a magnet a damaged ship in distress. After repairs on the latter, the "foreigners" take off for outer space.

"The gray mass resembling a gigantic millstone started to ascend, imperceptible to the eye. The huge disk rotated faster and faster. Soon the ship became no larger than a dot and then disappeared. . . ."

The author gives no indication of the structure and method of flight of the vehicle and, consequently, we refer it arbitrarily to the group of radio ships.

RADIOTELEMECHANICS

Radiotelemechanics is the science of remote control of mechanisms using radio. At present there are three methods used for developing radio-telemechanics:

1. Wireless telegraphy and telephony which are accomplished through the interception by receiving stations of a fractional part of all electromagnetic energy emitted by a transmitter. Gradually, radio engineering will find a means of transmitting mechanical energy at a distance. In 1925 Marconi, by directing radiowaves in one direction, could carry on a conversation by radiotelephone from England to Australia, a distance of 20,000 km, requiring for the purpose only 25 HP instead of the usual 450 HP.

2. The transmission of electric energy in considerable quantity which would be sufficient to bring into operation machines, lighting, etc. This problem is still far from a practical solution.

3. The transmission of electric energy in the comparatively small quantity necessary only for the control of mechanisms possessing their own power sources.

The idea of the application of radio to the transmission of mechanical work was born long ago.

In 1897, E. Wilson and C. Evans patented a telemechanical device used in planes, guns, etc.

A few years later in Germany, Professor Hergezell used radio to control sounding balloons at high altitude.

Further, Edison experimented with control of model planes at a distance. In 1903, the Spanish engineer L. Torres Quevedo succeeded in controlling a rudderless boat by radio.

In 1909, M. Antoni, an American engineer, conducted a successful experiment in radio control of an automatic plane during flight. Similar results were achieved by Hammond in 1910 and Roberts in 1912.

In 1914 the German engineer Siemens carried out an experiment of radio control of an aerial torpedo, and Fokker — an automatic airplane.

In 1917, the Germans directed an unmanned boat via radio control from an airplane into Newport Harbor, which was occupied by the Allies, and blew it up. In that year they also controlled motorboats by radio.

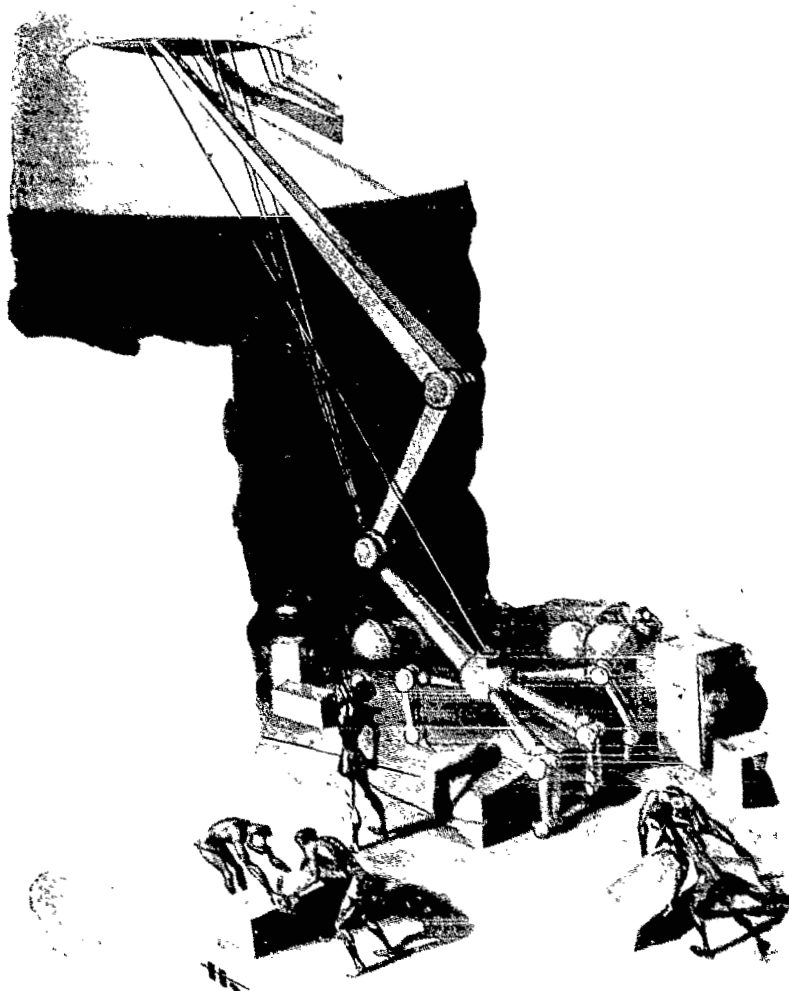

FIGURE 71. Volkov's Aviastella

In 1918, the French were successful in their experiment to achieve the independent flight of an airplane with automatic stabilization and navigation by radio. The distance covered was about 100 km along a complex path and the duration of flight was 51 minutes.

In 1921, the radio control of airplanes from another airplane was achieved.

Fairly recently there have been successful attempts to control underwater torpedoes, armored cars and automobiles by radio.

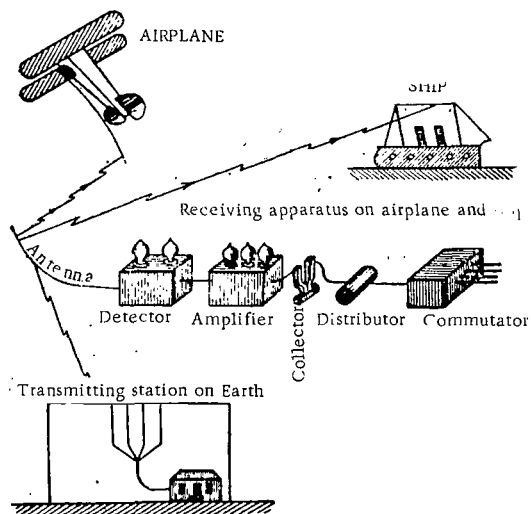

FIGURE 72. General scheme of radiotelemechanical transmission

Figure 72 shows the general scheme of radiomechanical transmission.

A transmitting station is set up on Earth (or in a plane, automobile or ship). There is an antenna in the plane (or ship) which receives radio-waves and transmits them to the receiving apparatus.

The receiving apparatus consists of a detector, amplifier and three instruments: collector, distributor and commutator, designed to receive only certain waves and transform them to perform a given operation.

The movement of rudders, cranks and other mechanisms of the ship is carried out by special gasoline, electric or pneumatic devices.

The latest experiments and the installation of the Marconi radio transmission stations with short waves for communications between England and her dominions open up new horizons in the field of application of radio-waves to telemechanics, and the application of the principles of their concentration and beaming in a certain direction by specially designed transmitters. *

* For further details see the article by P. Kuksenko "Pervaya radioprozhektornaya stantsiya Markoni" ["First Marconi Radio Transmission Station"] in the journal "Voyna i Tekhnika," No. 1. 1927.

HOFFMANN'S ANTIGRAVITATIONAL ELECTRIC SHIP

Oskar Hoffmann in his short story "Mack Milfords Reisen im Universum" describes a cosmic ship in which the hero flies from Earth to the Moon and to the planet Lilliput.

The ship is cigar-shaped. At the front there is a searchlight, and behind a parabolic reflector emitting magnetic waves of high strength. With the help of this current the force of terrestrial gravity is paralyzed (which is also of magnetic nature according to the author) and the vehicle is carried to the Moon by its attraction at a speed of up to 5,000 km/hr.

MADER'S ELECTRIC SHIP

F. Mader in the short story "Magical Worlds" describes an electric ship in which his hero travels to the planets. The vehicle is globular in form and is built of flint glass. There are six windows. The globe is 45 m in diameter. Inside there are many rooms for passengers, provisions and equipment.

It is propelled by magnetic current which counteracts the force of the Earth's and planetary attraction in general, which, in the opinion of the author, is also of magnetic origin. By exciting positive or negative magnetic currents in the ship, attraction towards and repulsion from the planets is possible.

TRANSMISSION OF MATERIAL OBJECTS BY RADIO

The theory of the occultists concerning the transfer of objects to a distance without visible means, as we find, for instance, in the novels of Kryzhanovskaya, "Gnev Bozhii" ["The Wrath of God"] and others, is also reflected in the modern novels. Below, we present an excerpt from A. Gorsh's science fiction tale entitled "Ekspress-molniya" ["A Telegram"] ("Mir Priklyuchenii," No. 4, 1928).

The tale starts with the experiments of scientists to reduce man in size so that he would thus be able to observe the structure of an atom. Conditions of travel would be eased for people, all of whom could be housed in a glass. However, an immense technical setup, occupying an extensive surface, is required and the microman would have to be transported with the entire arrangement.

Another method of transporting people was proposed and realized by the hero of the tale, Prof. Bobruiskii; in Sukhumi he built a powerful 1,000 kW station and started to transmit an object by radio using the new R rays, radio waves and specially controlled antennas.

This is how the author describes the professor's experiment to transmit by radio a dog, himself and a reporter who is present during the experiment.

"Control panels lined the walls of the room; numerous radio parts lay on the tables (Figure 73).



FIGURE 73. Transmission of objects by radio

"In the center stood a glass booth the height of a tall man. Inside the booth, the only things clearly visible were two chrome handles at the sides, which were placed where they could be grasped easily by the hands, and at the bottom were two supports in the shape of steps, obviously for the feet. Nearby lay a case half as big as the booth, made also of glass but with a metal bottom.

"The professor turned a lever slightly and pressed two switches. The whole room was filled with a greenish glow. A faint humming was audible, like the humming of a bee. In a few seconds could be felt the presence of some kind of substance in the air. The professor placed the dog in the glass case, attached a conductor to him and slammed the lever. A weak green light shone inside the case. A more piercing humming could now be heard. An instant — and the dog was no longer there.

"'Congratulations!' rang out a voice from Moscow from the loudspeaker, accompanied by a dog's bark. 'He arrived safe and sound, we're waiting!'"

Similarly, the professor and after him the reporter were carried from Sukhumi to Moscow.

TRANSMISSION OF ATOMS TO THE PLANETS

In "Mack Milfords Reisen im Universum" Hoffmann tells of an invention of his hero which could transmit objects to outer space at the speed of light.

With an alternating current of high tension, objects were broken down into atoms and carried to a known planet. There they were reassembled into the original objects, organic or inorganic, dead or alive. Milford dispatches his assistant and servant to the Moon in this manner.

Chapter VIII

THE USE OF INTRA-ATOMIC ENERGY

"Our modes of perception are very limited and incomplete. But science will broaden them, opening up to our minds an invisible world, infinitely vast in comparison with our visible world – a simple, light soap bubble."

C. Flammarion

The successes of physics in the past few years in research into the structure of atoms has fired the imagination of writers, who have embarked on novels describing flights in outer space powered by energy obtained from the splitting of atoms.



FIGURE 74. The Selenites' atomic ship (according to Goncharov)

GONCHAROV'S ATOMIC SHIP

V. Goncharov, in the science fiction novel "Psikho-Mashina" ["Psycho Machine"], 1924, describes a vehicle in which Moon dwellers fly in the lunar atmosphere. The energy for this purpose comes from the splitting of atoms. Its climbing range is not more than 10 km. It has wings (Figure 74) and is armed.

WIGNALL AND KNOX'S "SUBLIMIUM"

The English writers Wignall and Knox in the novel "Atoms" tell of the Englishman Grant who discovers a new substance, "sublimium," which can transform matter into energy immediately through rapid splitting of the atom. If the substance which is to be split is soaked in it, its electrons rapidly start to release energy. "Sublimium" can be preserved only in vessels made of a new substance "refractine," which does not yield to its influence.

F. ULINSKY'S REACTIVE ELECTRONIC SHIP

The Austrian scientist F. A. Ulinsky has proposed two types of interplanetary ships that are propelled by the reaction force of electrons ejected from a row of ejectors arranged around the ship. In ships of the first type the electrons are obtained by means of solar energy caught by huge shields — thermo-elements — surrounding the ship and transformed into electricity. In ships of the second type these electrons are decay products of atomic matter.

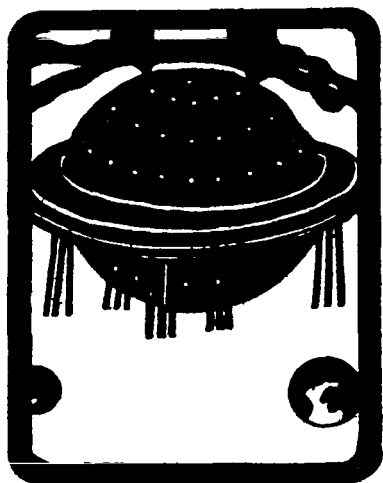

FIGURE 75. Ulinsky's ship

Many scientists have tried to determine the energy of electrons, like Max Abraham, for example, who determined the energy of electrons in 1 g of matter as $6 \cdot 10^{13}$ joules, or 8 million HP.

Under these conditions a few grams of copper would be enough for a journey to Venus. The problem is to transform the potential energy of an atom partly or completely into kinetic energy.

a) The use of solar energy

The objective is to transform solar energy into electrical energy. To achieve this end, one might imagine a thermoelement consisting of different overlapping metal disks forming thermocouples. If the disks are subjected to different temperatures,

currents arise between them; for example, in the experiments of the engineer Privigei, using a bismuth-cuprous sulfide thermocouple with a temperature difference of 100° , a current with a potential of 0.8 volts is obtained.

We can accept that beyond the boundaries of the Earth's atmosphere each square meter of surface facing the Sun's rays receives 20 units of heat per minute, i. e., around $1\frac{1}{2}$ KW or 2 HP.

Considering the cooling by radiation in the cold of outer space (ca. -273°), and on the basis of experiments conducted on Earth (with $+30^\circ$ on one side of the disks and -70° on the other), it is possible to accept that only 25% of solar energy, i. e., $\frac{1}{2}$ HP for each m^2 , will be used. Under these conditions the interplanetary vehicle might have a surface of 500–1,000 m^2 . The thermoelements would form a large flat disk, in the center of which the ship with its cabins would be situated. If a vehicle of this kind is used for flying over the Earth, the surplus energy could be radiated by antennas. Conversely, in the event of a shortage of energy it could be obtained from Earth stations via the same antennas.

b) Use of intra-atomic energy

With the disintegration of an atom an enormous amount of energy is liberated, and the fission particles separating from the atom and traveling away may be sent in a determined direction. They then produce a reaction in the opposite direction which can be utilized for movement. Experimentally, this is demonstrated by the following device (Figure 76). Air is pumped out of a flask, and electrons are emitted from cathode to anode at a high voltage; under reported conditions a reaction of 2–3 kg/cm^2 may be achieved, which is already enough to overcome the force of attraction of a small planet. In such a situation there is no longer the need

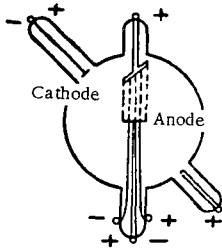

FIGURE 76. Reaction of electrons

to reduce the mass of the interplanetary or the cosmic vehicle. The necessary energy may be obtained in sufficient quantity from matter. The cost of flying from Venus or Mars, notwithstanding the expensive structure and tremendous distance, will not be any higher than a journey from Hamburg to New York, for example.

Doctors Pohl and Pringsheim, during an investigation of photoelectric phenomena, discovered that one electron yields an energy of 10^{-11} coulomb. Since 1 coulomb is 1 ampere-second, the energy value will, be equal to about $0.102 \cdot 10^{-12}$ m kg/sec.

In electrolysis of water, one gram of hydrogen receives an electrical charge of 96,000 coulombs.

One small globe charged with one coulomb removed 1 cm from another small globe with the same charge will repel it or be attracted to it with a force of 9^{18} dynes. Accordingly to Millikan, the value of the electronic charge e is equal to $4.774 \cdot 10^{-10}$ esu; if the number of electrons in a gram of matter is equal to 10^{20} , then the mass of 1 electron is $5 \cdot 10^{-30}$ g.

The electronic energy emitted by 1 g of matter is equal to about $5 \cdot 10^6$ W.

In the radiation of dense bodies the initial speed reaches only 30,000 km/sec and the radiation of energy only $5 \cdot 10^4$ W.

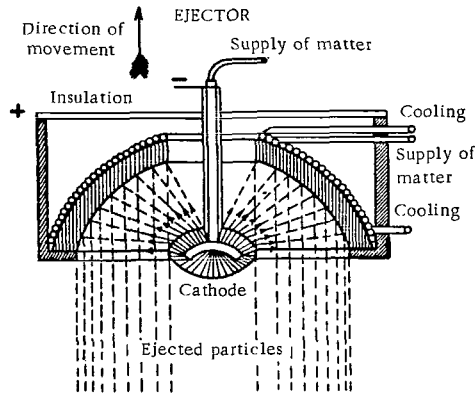

FIGURE 77. Ulinsky's electron ejector

For the reactive propulsion of a cosmic ship with a load of 20 wagons at a speed of only 1 km/sec, 10,000 kW would theoretically be sufficient which with an efficiency of 20% would require about 50,000 kW or 60,000 HP, i. e., a power now used on ocean liners.

Small planetary ships for a small number of people and short distance flights should be constructed for the first experiments; their power will not be great.

Let the mass of a ship correspond to 200,000 kg of weight. Then, at a normal terrestrial speed of flight of 180 km/hr, the outlay per second would be 5 g of reactive substance. This would call for such an enormous quantity of substance, something like mercury, for example, that the possibility of the flight would remain in doubt if this were not helped by the circumstances of cosmic flight. The speed of movement of the Earth is 29.5 km/sec; this speed is attained at the moment of takeoff and with it we fly into outer space until we reach the sphere of action of Venus, whose speed is equal to about 34.8 km/sec. Nevertheless, to counteract the attraction of other planets and to alter the direction of flight, much more material is required. Thus it can be said that without the force of gravity, flight would be impossible; it is facilitated thanks to the law of inertia.

The required quantity of energy has to be spent in full measure only during takeoff or arrival at the planets. In departing from them the expenditure of energy decreases proportionately to the masses of the planets, and is limited only by the conditions of altering course while changing speed of about 5.3 km/sec, which is sufficient to overcome the force of the Sun's attraction during the flight to Venus.

The general structure of a reactive electrical apparatus (electron ejector) is as follows (Figure 77).

The principal device is a parabolic anode at whose focal point there is placed a cathode sending high voltage currents to the anode, and the latter reflects them in parallel directions counter to the direction of the flight.

A system of radiator pipes is envisaged to cool the walls of the apparatus from the heat radiated under these conditions.

c) Construction, equipment and navigation of the "cosmic" ship

Type 1 — **The interplanetary ship** (Figure 78) is propelled by solar energy. It has a large disk of thermoelements in the center of which the ship itself is suspended on a universal (Cardan) joint, so that it will be possible to change the direction of the reaction. Otherwise, the two ships are similar to each other and may be small in size. The navigation of the solar ship is more difficult and entirely dependent on solar radiation if a storage battery is not provided. Ascent and descent are possible only to the nearest planet since very little light energy is obtained at a great distance from the Sun.

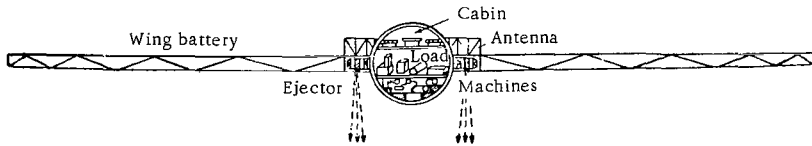

FIGURE 78. Ulinsky's ship. Type 1 — electronic

Type 2 — **The "cosmic" ship** (Figure 79) is more convenient. In shape it can be like the celestial bodies — globular. This shape is convenient for the universal joint which is necessary to change the direction of the reaction. Also, this shape best prevents the explosion of the envelope and resists internal excess pressure; on the other hand, it satisfactorily resists compression under external pressure.

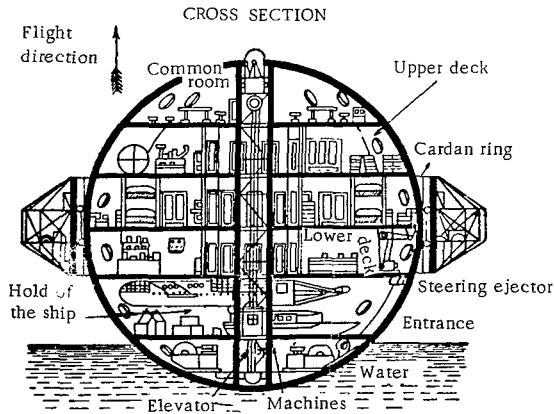

FIGURE 79. Ulinsky's cosmic ship

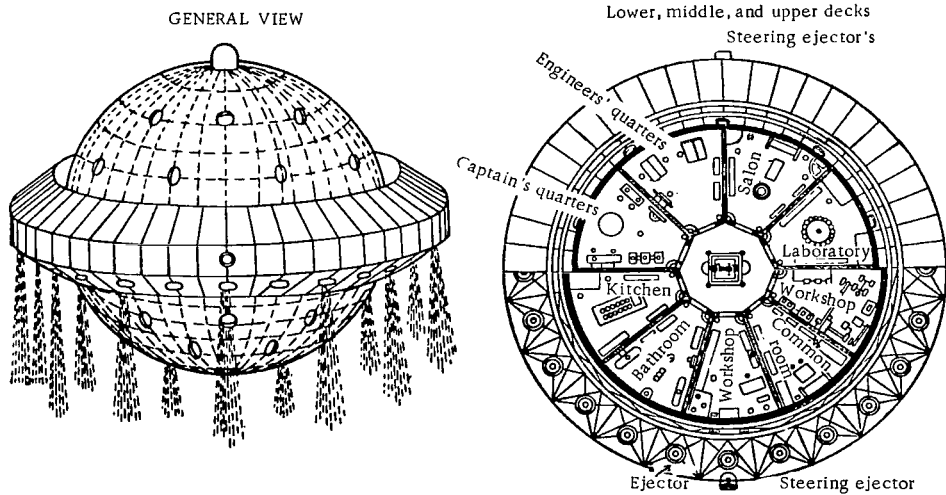

FIGURE 80

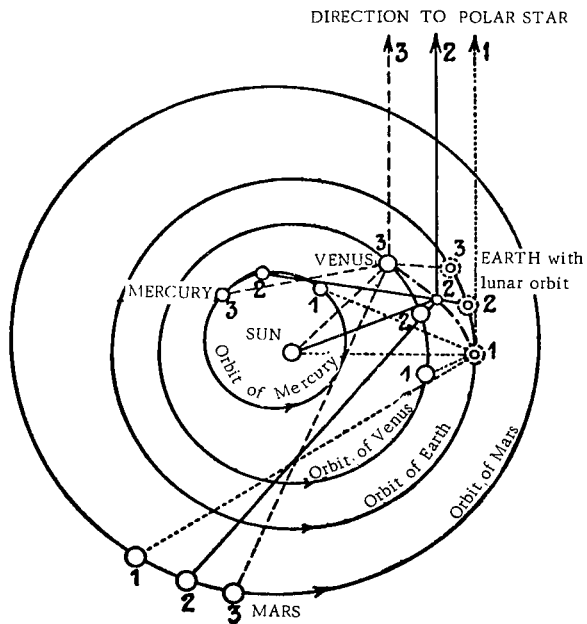

FIGURE 81. Orientation during interplanetary flight

The envelope of the ship should consist of the following parts: the exterior — steel soldered with copper and reinforced with cross bars — is a conductor of heat; the cross bars are covered with sheets of asbestos. The inner side is covered with thin plywood sheets with rubberized fabric inserted between them. Gaps that may occur in the outer envelope during the journey are found with the help of mirrors and are repaired by autogenous welding. Figure 80 shows details of the construction and the different quarters. The floors are connected by stairways. The lower floor is occupied by the machine department. It is filled with all the heavy instruments. On the second floor there is a hold for cargo. These floors should be as far away as possible from the center of the globe. The third floor contains the kitchen, lavatories and baths; the fourth floor, the passenger cabins; the fifth floor, crew quarters and a promenade deck; the sixth floor, the upper hall. There is a large area for passenger movement.

The pilot sits at the top of the globe near the pole. The ship is furnished with supplies of oxygen, fuel, provisions, telephones, instruments, etc.

Inside, the globe is filled with ordinary air at normal atmospheric pressure. Air that is not suitable for breathing is absorbed and purified by apparatus located in a special compartment, where research is conducted into the composition and pressure of the external surroundings. The control cabin of the pilot is equipped with the necessary instruments: speed indicator (ether-tachometer), mass indicator, radiotelegraph station, level indicator. The pilot can be transferred to the lower pole of the globe by elevator, for example to observe the stars and the Sun. For orientation a map of the stellar sky is necessary. The start and descent must take place on water and as close to midnight as possible. With a weight of 200,000 kg and a diameter of 20 m, the ship is submerged to 2.5 m in water.

Cross bearings taken at the beginning of the flight to the Sun, Mercury, Mars, Venus and the Polar Star, and later to Venus and Earth, serve as orientation guides (Figure 81).

ULINSKY'S SCHEME FOR A NEW INTERPLANETARY ELECTRONIC ROCKET

In Austria, Franz Ulinsky patented a design for a new interplanetary ship which does not require massive supplies of fuel but exploits the energy of the Sun's rays.

The structure, which consists of the following, is shown in Figure 82. The disk encircling the cabin of the ship serves as a thermoelement and transforms solar energy into electrical energy. The electromotive force thus obtained serves for the flight in the atmosphere as well as in the vacuum between the planets. In the first case, accordingly, the converted electrical energy brings into action a turbocompressor operating on a reactive device with a nozzle. In the second case, it brings electron ejectors into action.

The reactive device with a nozzle consists of a chamber receiving high-pressure gas from a pipe nozzle at the top. Below the chamber a low-pressure pipe leads in the direction of the turbocompressor which then raises the pressure to the required level and drives the gas in the pipe

through the nozzle in the top part of the chamber. Because of the ejection of gas from the nozzle a reaction occurs in the chamber, serving as the motive force of the ship, as takes place in rockets, with the slight difference that because of the cycle there is no loss of matter (we have only the author's author's word that this is indeed so).

The contradiction of this idea to the laws of mechanics, however, does not prevent interest in another idea of Ulinsky's, namely the construction of electron ejectors which in their reactive effect are similar to a rocket ship, save that instead of gases — the products of the explosion of fuel substances — electrons stream from the nozzle, ejected from the cathode sources and appearing as the result of the action of solar energy, converted into electrical energy, on a small quantity of matter.

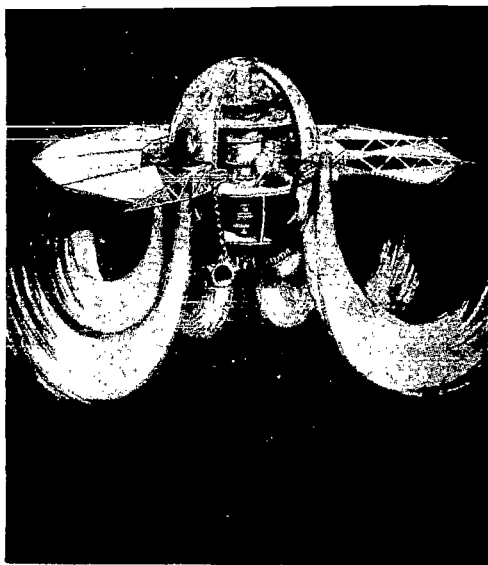

FIGURE 82. Ulinsky's scheme for a new interplanetary electronic rocket

A potential of 250,000 volts is needed to bring the ejectors into action. The current is intermittent, and the shorter the current pulse in comparison with the interruption, the better. The initial constant current is transformed into a high-voltage current of required frequency with the help of a gas centrifugal cut-out.

A solenoid transformer occupies half the space of the chamber described above. The axis of the solenoid is directed longitudinally to the ship; a strong magnetic field is formed due to the solenoid and cathode rays appear as a result.

Each of the ejectors placed around the ship consists of three parts. A cathode is inserted in the solenoid and is brought to red heat by means of a special heating disk. The solenoid, when connected to a second battery,

produces an electromagnetic field. When a current of the required voltage develops between the two, electrons fly from the incandescent cathode along the lines of force of the anode solenoid and reach the most important part of the structure — the main cathode. Between it and the anode passes a current at a potential of 250,000 volts which drives electrons from a tungsten spiral filled with an amalgam of barium. These electrons fly from the ejectors in great quantities and with immense acceleration.

In order to overcome the weight of such a ship of 3,000 kg near the Earth, 5g of matter (a mercury preparation) must be converted into electrons per second. This rate of consumption decreases as the ship draws away from the Earth.



FIGURE 83. F. A. Ulinsky

If the ship ascends with an acceleration of 15 m/sec^2 , in the course of 1,800 seconds it will achieve a parabolic speed sufficient to leave the Earth. For this purpose 15 kg of matter is enough, whereas in an ordinary rocket 150 tons of fuel is required for 3 tons of useful weight.

If such a ship is constructed, then with the help of electron ejectors it will be able to fly only in airless space. It must fly through the terrestrial atmosphere with the aid of the reactive device with a nozzle (and this, notwithstanding the conviction of the author, is impossible).

Franz Ulinsky (Figure 83) was born in Blodorf (Mähren) in 1890 of a distinguished old Polish family. He studied in the high school in Wels and did his

matriculation in Linz. In 1910 he entered military service and remained for a year as an officer in the Quartermaster Corps. Interested in technology, he became self-taught in this field. When war broke out, it was due to his work on the construction of gas turbines that he was transferred to the Austro-Hungarian Air Force and detailed to the Higher Technical School in Vienna. Later, he was assigned to head the work at the motor aviation plant in Fischamend. At this time he became interested in the problem of interplanetary communication and invented a differential parachute of great lifting capacity; after the war he worked as an engineer for various companies. During this migratory life he undertook many practical investigations into high capacity automatic absorption refrigerators, which gave him the impetus to design a cosmic ship utilizing the idea of temperature differences, and inspired him to conceive of flying in outer space.

It seems that Ulinsky started to work on the design of a rocket ship as far back as 1901. At least this is evident from the exhibition of interplanetary vehicles in Moscow in 1927, which displayed the model and design of his vehicle, referring to the year 1901, and noting that for fuel it used dust (Figure 84). Details of Ulinsky's vehicle may be found in the article "Die sonderbaren Wege zur Realisierung der Weltraumfahrt," Tuida von Picquet, Leipzig. 1928.



FIGURE 84. Model of Ulinsky's ship

ROCKENFELLER'S ROCKET SHIP

In Germany in 1926, under the influence of Ulinsky, Rockenfeller published his scheme for a spherical rocket ship, similar in structure and outward form to the Austrian design.

Figures 85 and 86 show the section and outer view of the ship. Although no description is given by the author, one might be led to think that streams of ejected combustion products come out of the opening located in the equatorial zone of the ship. The three extensions below serve as supports.

HANS DOMINIK'S ELECTRONIC ROCKETS

Flights in rockets propelled by the force of reaction of electrons ejected from them served as the theme of H. Dominik's "Das Erbe der Uraniden."

The author describes three rockets of this type:

1. A rocket by the inventor genius Gorm
2. A rocket by the American Robert Lee.
3. A rocket by the American Garrod.

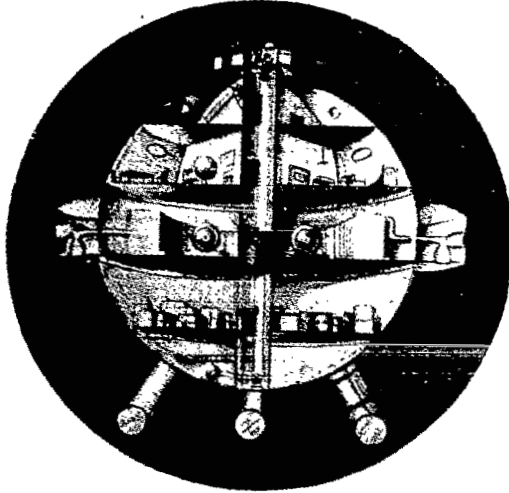

FIGURE 85. Rockefeller's rocket ship: section

The basic principle of construction was discovered by Gorm, who succeeded in building an engine from which electrons were ejected with the speed of light.

All three vehicles flew to Venus successfully. Flight speed for one was 600 km/sec and for another 1,200 km/sec.

On Venus, the travelers found an unknown type of cosmic ship belonging to the Uranides — visitors from another solar system — abandoned

on Venus. The ship was distinguished from the previously mentioned terrestrial vehicles by its dimensions (twice as large), the simplicity of its structure and its great speed. In addition, it was constructed of an unusually durable and light material, apparently a compound of two gases.

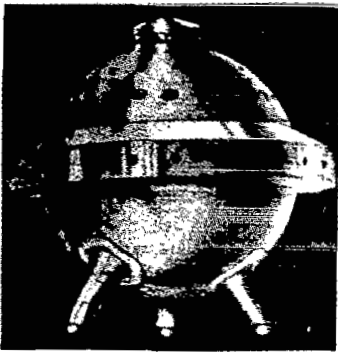

FIGURE 86. Rockefeller's rocket ship: outside view

POSSIBILITY OF FLYING OUTSIDE THE ATMOSPHERE (COROCCO'S OPINION)

The well-known figure in aviation and aeronautics, G. A. Corocco, presented a report to the Italian Academy of Sciences in April 1923 on the possibility of flight outside the atmosphere.

The highlights of his report are presented in the following (quoted from the account appearing in "Atti dell' associazione Italiana di Aerotecnica," Vol. III, 1923).

To fly outside the atmosphere it is necessary to have a reactive apparatus for which the minimum speed of ejecting explosive materials (v) and movement (V) of the apparatus must be:

$$\begin{aligned}v &= 360,000 \text{ m/sec} \\V &= 11,000 \text{ m/sec}\end{aligned}$$

Thus far, man does not have at his disposal a substance which during explosion would yield the indicated v . In order for 1 kg of substance, under the conditions of extracting from it an energy of $\frac{v^2}{2}$, to yield such a speed it must yield 15 million kilocalories. Up to now the highest energy of chemical reaction does not even yield 1/1,000 part of this value.

Flying on the principle of an airplane in a strongly rarefied atmosphere, this value markedly decreases. For example, assuming that the speed of flight is inversely proportional to the square of air density, we get a flight speed of 5,000 m/sec and a speed of ejection of 75,000 m/sec.

However, even these values are not obtainable with the types of fuel known to us, which yield a 50 times smaller amount of energy. The task will be solved when substances that disintegrate with a speed corresponding to radioactivity are used.

How to utilize and control a force obtained in this way? That is also a complex question. But, assuming that it is made available to us, let us examine two cases of its application: direct and indirect.

The **direct** way presumes the uninterrupted ejection of α -particles, as in radioactive substances, with a speed of from 10 to 20 million m/sec but without the conversion of energy to heat. This can be obtained under the effect of strong electrical discharges on the nuclei of atoms, generating kinetic energy. In this case it is possible to direct the current in a single direction, as takes place in Crookes tubes, and this would be the best way of solving the question.

If the ejection occurs to various sides, the direction of movement of the particles must be changed, compelling their main mass to move in the desired direction. At the same time part of the energy is inevitably converted into heat, which could be used in part for the generation of the necessary electromagnetic field; some of the heat is carried away by the products of explosion and, finally, some is lost through radiation.

The **indirect** method presumes that all the energy developed, or part of it, will be converted into heat, and therefore it should be transformed for the ejection of other inert matter. Of course, part of the energy will dissipate uselessly. However, once the above-mentioned source of energy is dissipated it could be utilized, even though only partly; for example, if $v = 20$ million m/sec, it is possible to obtain a maximum of $V = 60,000$ m/sec or an average of $V = 30$ km/sec.

Control of the apparatus is achieved by rotating the generator of ejection speed around the center of mass. For such a rotation, a reaction engine forming a couple of forces which rotate the apparatus could be used.

For the comfort of the passengers, artificial gravity within the apparatus can be created by acceleration or a rectilinear or curvilinear movement of the vehicle. It would be possible to fly from the Earth to the Moon in 4 hours, and from the Earth to Venus in 8 days.

ESNAULT-PELTERIE WORK AND GODDARD'S OPINION

We note that back in 1913 in France the work of an engineer, Robert Esnault-Pelterie, made its appearance; in it he indicated the desirability of exploiting intra-atomic energy for interplanetary travel.

Once man finds a way of exploiting intra-atomic energy, broad avenues for new investigations will open up. Until then, known means of obtaining energy will have to be used. Goddard, in his work "A Method of Reaching Extreme Altitudes," also subscribes to this opinion, saying: "Since intra-atomic energy is not available to us, we must utilize the energy of explosive gases."

FLIGHT INTO OUTER SPACE WITH THE HELP OF THE ATTRACTION OF "NIHILIUM"

The German novelist R. Eichaker, in his novel "Die Fahrt ins Nichts", Munich, 1924 (Russian title "Nigilii") ("Mir Priklyuchenii," Nos. 6-9, 1926), describes a manned flight in a hermetically sealed missile in outer space with the assistance of a meteorite.

The event occurred in the following way:

From outer space a strange meteorite plunged to a depth of 10,000 m in the Pacific Ocean. Two fragments of the meteorite fell to Earth. The scientist Werndt succeeded in discovering the composition and remarkable properties of a substance of the meteorite unknown on Earth, which was called "nihilium" and had enormous energy.

Two expeditions were organized to retrieve the meteorite from the ocean. One expedition perished on colliding with it. As a consequence of this collision, the meteorite swiftly flew upwards, carrying with it the missile containing the second expedition, including Werndt, and all were carried off into outer space. Some time later radio signals were received on Earth which seemed to be coming from Werndt, but the ship vanished without a trace.

FLIGHT WITH THE AID OF CONCENTRATED ENERGY

A. Bobrishchev-Pushkin, in his short story "Zaletnyi Gost'" ["The Flying Guest"] ("Mir Priklyuchenii," No. 1, 1927), tells how an inhabitant of another world, who resembled a human being, flew down to Earth.

He moved in outer space without a vehicle, his body secreting certain fluids impervious to the external effects (cold, shock). A small pocket device with a huge supply of concentrated energy was his engine.

Thanks to this power he landed on Earth. When somebody curious undid one of the screws of the engine, the force of the ejected jet carried off the flying guest into outer space.

REACTIVE SHIP OF THE 30TH CENTURY (NIKOL'SKII)

The engineer V. D. Nikol'skii in his science fiction novel "Cherez Tysyachu Let"* [In One Thousand Years"] describes how, in the year 3000, a vehicle is invented which can move in the air through the force of reaction of disintegration products of atoms ejected from it. The ship itself was around 30 m long and in shape resembled a fish with two short thick wings at its sides. The lower part and the wings were made of some kind of silvery white metal, and the upper half was constructed of a transparent material through which the internal reinforcements of the frame were visible (Figures 87 and 88). Along the sides of the ship were located the oval apertures of the gas ejectors of the reactive engine.

Situated in the bow was the pilot's cabin with its numerous automatic instruments and an indicator of speed, inclination and direction, proximity to Earth, etc. The cabin was covered with a very transparent material so that one had the impression of being in the open air. Alongside this was the compartment housing the gas reactive engines, whose control was so simple that the services of a mechanic were not required. Further on were four passenger cabins, a lavatory, a bathroom and a hold for luggage. The ship was capable of developing a speed of 10 km/sec and transforming itself into a satellite of the Earth.

FLIGHT WITH A COMET FROM EARTH TO MARS ON RADLEY'S "GREEN MACHINE"

The English writer, F. A. Radley, in his story "The Green Machine" describes the flight of an Earth dweller to Mars by means of a special "green" machine and a comet. The structure of the machine and the flight were as follows:

The machine resembled an ordinary motorcycle, was of a bright green color and gleamed in the Sun. It had a pair of auxiliary pedals made of some kind of original metal alloy; these pedals acted as brakes during the descent to Mars; above the machine there hung a device of the same metal, which looked like an umbrella and was attached to the rudder. The power of the machine was colossal and its inventor came near to solving the problem of perpetual motion. Set into motion by some sort of internal force, the machine could fly hundreds of millions of miles. Its speed was phenomenal.

* Supplement to the journal "Vestnik Znaniya" for 1927, Series "Priroda i Lyudi."

The suit worn by the passenger was made of an elastic material like rubber, and there was a helmet resembling a gas mask. The suit protected the traveler from the cold of interplanetary space.

The flight from Earth to Mars was as follows: the traveler ascended in his machine from Earth to a high altitude, selecting the moment when Philips's comet during its flight would touch the orbits of Earth and of Mars. Later the machine entered the sphere of attraction of the comet, and with it completed the flight from Earth to Mars.

There proved to be an atmosphere on Mars and the traveler, freeing himself from the comet by the force of his machine, safely landed on Mars' surface. The speed of flight together with the comet was around 1,000 miles per second.

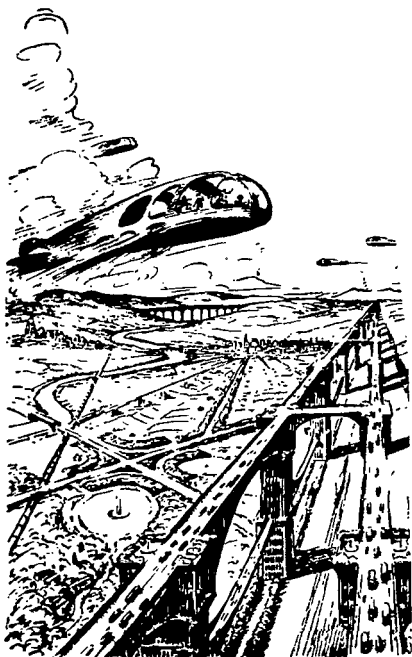

FIGURE 87. General view of Nikol'skii's ship

MARAL-VIGÉE'S ROCKET

In 1922 there appeared in Paris the novel by Maral-Vigée "Fiery Ring." The author described the flight of four persons in a rocket from Earth to Mars and Saturn, and back to Earth.

The technical plot of the novel was based on the calculations and theories of the French engineer Esnault-Pelterie, who in 1913 published an article on the possibility of flying to the Moon. He proposed radium as the explosive element which, when decaying, would

provide the reaction force necessary for the flight.

The author of the novel states that 1 g of radium in the course of an hour develops an amount of energy capable of lifting this weight to an altitude of 34 km. This energy is several billion HP. The energy contained in 1 kg is 5,670 times greater than that needed for a flight to the Moon. During the flight, the acceleration of motion is conjectured to be equal to $\frac{11}{10}$ of Earth's gravity. Consequently, the increase of weight of the passengers would be negligible.

Plot of the novel. Three French scientists discover a new substance called "virium" that is far more powerful than radium. In spite of German intrigues they fly with their servant into cosmic space in a rocket propelled by the reaction force of virium, their destination being Saturn. They fly past the Moon. When they attempt to by-pass Mars, they feel that their rocket is being pulled by the planet. There is nothing left for them to do but descend on it. Here they are joyfully greeted by the Martians, who look

like humans but are far more developed. From them they learn that in 1787 the Martians flew to Earth in a vehicle similar to theirs, and brought back a man whose descendants were living on Mars to that day.

The heroes of the novel then fly on to Saturn, land and discover not only primitive beings but also their enemies, the Germans, who had stolen their secret while still on Earth, built a similar rocket and flown to Saturn. In the ensuing battle all the Germans are killed save for one who is taken prisoner.

The travelers then return safely to Earth.



FIGURE 88. The bow of Nikol'skii's ship

Let us proceed now to an account of the technical details of the novel.

Virium. The heroes of the novel, the engineers Esperé and Henri Vaulsor, had discovered a way of obtaining a substance from radium salts that was 60,000 times more active than radium, which they called "virium." In order to accumulate a large quantity they traveled to the Pacific Ocean, and on one

island they found a radioactive ore of volcanic origin from which they extracted the virium. Three kilograms of this substance were sufficient for the flight from Earth to Saturn and the return.

Since virium disintegrated slowly, they invented a method called "physical catalysis" to hasten the process. A beam of cathode rays was directed at the virium, which under their influence disintegrated violently with the release of the required energy.

The rocket (Figure 89) was oval in shape and made of nickel steel. Half of it (lengthwise) was blackened and the other half burnished. Therefore, if its blackened side were turned to the Sun it would heat up, whereas the burnished side would merely reflect the rays. There were four walls to the rocket, which formed between them three layers of rarefied air to protect the passengers from the cold of outer space. Beneath the vehicle were leg-buffers to deaden the impact on landing. The rocket was entered from below between the legs, where there was a round glass hatch; the overall height of the rocket was around 14 m; the largest diameter was 4 m. Inside the rocket was a shaft 1 m in diameter with a staircase, and around the shaft the premises were arranged on four floors.



FIGURE 89. Maral-Vigée's rocket

The first (lower) floor housed the combustion chamber, from which the products of virium disintegration were ejected through three steel pipes (Figure 90).

Above this chamber supplies of the substance were stored in a lead container.

On the second floor there were the passengers' cabins, 4.5 m high, with full equipment. In this section there were four windows.

The third and fourth floors (4 m high) were storehouses.

Above, the shaft led into a small compartment with a skylight (window).

In the rocket there were telescopes, instruments, absorbers of impure air, and air locks for exit outside. The provisions taken on were reckoned at 1 kg of food and 2 liters of water per person per 24 hours (a total of 2,000 kg of food and 2,500 l of water for 4 persons for 4 months).

To turn the rocket about its longitudinal axis, three exhaust pipes at an angle of 120° to each other were built along the sides perpendicular to the axis. A significant property of the exhaust pipes was the resistance of their metal (molybdenum steel) to melting under the influence of the virium.

With the rocket in a vertical position, **takeoff** took place through the reaction force of the ejected gases.

During the ascent a slightly inclined position was employed and the ship, with gradually increasing speed, was carried off into outer space.

The distance traveled was determined by measuring the visible diameter of the stars.

The flight to the Moon took place at a speed of 60 km/sec, to Mars at 800 km/sec and to Saturn at the onset at 1,000 and later at 1,200 km/sec.

When they reached Mars the travelers were forced to land, although this had not been part of their plan. It seemed that the inhabitants of Mars had counteracted the reaction of the rocket with the help of gravitational rays and drawn the rocket to their planet. After a stay on Mars, the travelers flew to Saturn, where they were able to land with the help of retrograde reaction of gases. Their return home took place in the same order and they landed safely in France.

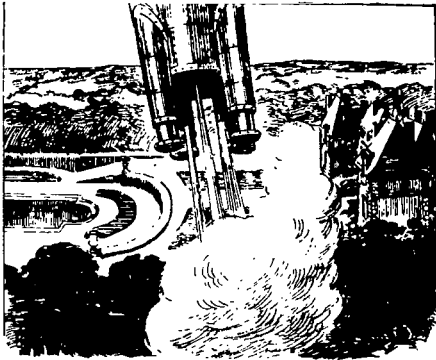

FIGURE 90. A detail of the Maral-Vigée rocket

A. Ya. FEDOROV'S ATOMIC ROCKET SHIP

Fedorov exhibited the model and description of his cosmic ship at the exhibition of interplanetary vehicles in Moscow in 1927. In the description contained in the catalogue of the exhibition, we read:

Fedorov anticipates achieving propulsion of his rocket with the electrochemical energy resulting from the use of intra-atomic energy. The rocket is streamlined. The speed during takeoff from Earth is from 0 to 1,000 km/hr, and subsequently up to 25 km/sec. The load capacity is 6 persons, the weight with fuel 80,000 kg, diameter 8 m, length 60 m. The solar engines provide the rocket with the possibility of flying not only in the solar system but even beyond its confines into the stellar wilderness.

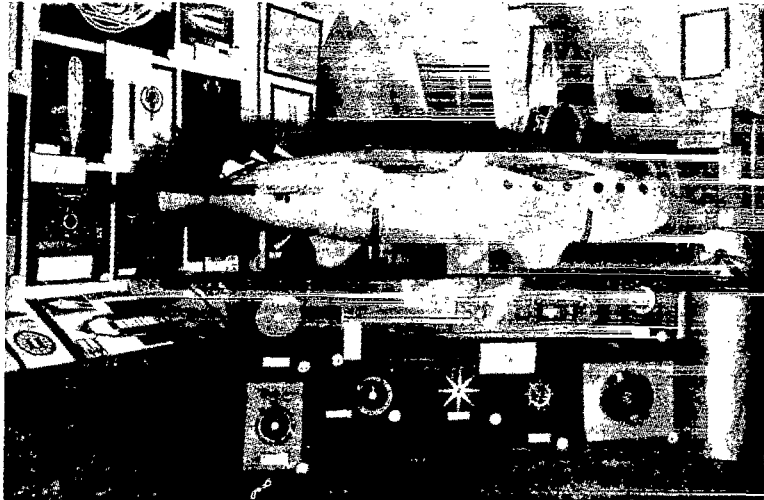

FIGURE 91. General view of Fedorov's atomic rocket ship



FIGURE 92. Longitudinal section of Fedorov's ship

Figure 91 gives a general view of Fedorov's vehicle. Above we can see the two propellers for takeoff, the front propeller, the principal nozzle at the rear, secondary nozzles and folding wings at the sides. This is how the rocket looks during takeoff. During the flight in outer space the propellers and wings are withdrawn. In Figures 92, 93, 94 are shown the longitudinal section of the rocket, the arrangement of the engine compartment and the temperature regulator. A description of these devices is not given.

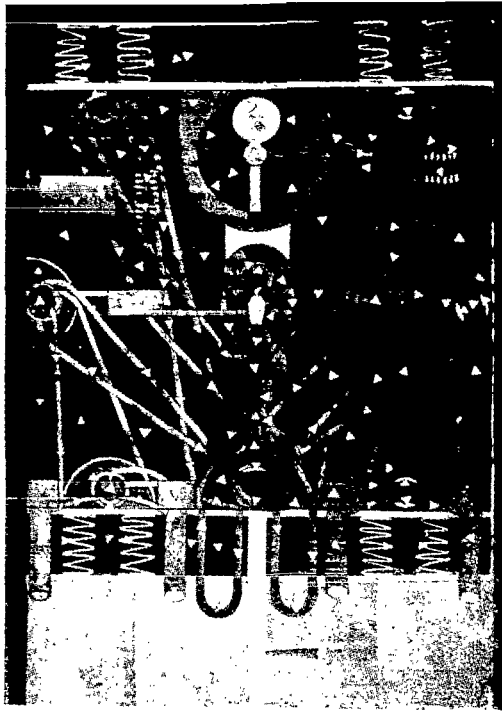

FIGURE 93. Engine compartment of Fedorov's ship

KREIN'S ROCKET

At the exhibition of interplanetary vehicles in Moscow in 1927, the project of G. Krein was exhibited, with a very short description. This vehicle uses electrical energy. For descent there are parachutes; its design is shown in Figure 95 [see page 128].

AUGSTON'S URANO-SHIP

I. Augston, in his science fiction tale "Interplanetary Columbuses," gives a description of a flight from Earth to Mars in a "urano-ship" — a reactive apparatus whose energy is obtained through the disintegration of atoms. Figure 96 shows the general view of the vehicle [see page 129].

The passengers left Earth comfortably seated in the vehicle and listening to concerts transmitted from Earth, Mars and Venus over the radio.

During the flight the ship encountered a derelict ship resembling their own which was carrying human corpses along the orbit of Halley's comet.

Later they fell into a stream of meteorites which bombarded their walls; they were thrown off course and arrived on Mars 10 hours late.

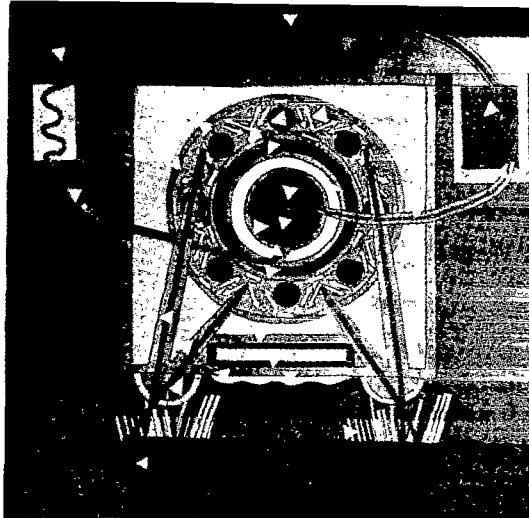

FIGURE 94. The temperature regulator in Fedorov's ship

GENERAL CONCLUSION REGARDING THE USE OF INTRA-ATOMIC ENERGY

The question of intra-atomic energy to propel cosmic ships remains open for the time being, since we cannot obtain this energy. However, science is striving to solve this question, posing as a beginning a converse aim — how to split the atom. For this purpose energy of colossal intensity is required. Experiments in this direction have been conducted for a long time in the United States, England, Germany, Italy and other countries. It is hoped that this energy will be obtained in the cheapest way from atmospheric electricity. Attempts to obtain a potential of 2,600,000 volts by three German scientists in the Alps were successful; at the same time they obtained sparks around 2 m in length by extracting electricity from the air in clear weather. For this purpose they threw a 6.70-m-long cable, with a silk net attached, across a mountain pass. The net gathered the electricity and directed it in insulated conductors to a place where sparks were obtained and then passed on to a laboratory. The experimenters hope to obtain a potential of 10,000,000 volts in the near future.

Chapter IX

ROCKET SHIPS

COSMIC SHIP

The inquisitive mind of man yearns
To see the light of faraway worlds,
On the wings of a fiery rocket
He believes in this bold feat.

And you, the mighty creation
Of knowledge, will and toil,
Strive to pierce the Universe
And you will win! Fly on!

No one has been able to penetrate the remoteness
But you in time will vanquish the oppression.
Your breast of steel will invade space
Forward, cosmic ship!

"Weltraumschiff" by Irma Gohl*

This chapter contains a description of interplanetary ships moving on the principle of the rocket. The first to express the idea of this type of movement in its application to interplanetary travel was apparently Cyrano de Bergerac, later followed by Jules Verne. In recent years, accompanying the investigations conducted into reactive engines by such scientists as Tsiolkovskii, Oberth, Hohmann, Goddard and others, the number of novels employing the principle of rockets in connection with interplanetary flight has grown tremendously and continues to do so.

JULES VERNE'S ROCKET ENGINE

The idea of using a rocket engine for interplanetary travel was provided by Jules Verne in 1874, the year that the Russian translation of his "Autour de la Lune" (St. Petersburg, 2nd ed., D. E. Kozhanchikov), a sequel to "De la Terre à la Lune", was published; in the earlier book he described the preparation of a gun and a projectile in which three passengers would fly to the Moon. In reply to the question posed by one of the opponents of the project, as to what would be done to prevent the earlier book he described the glass during the fall onto the Moon, the answer was: "And what is to prevent slowing down the fall of the projectile with rockets expediently arranged and opportunely fired?" Twelve small steel guns, arranged around the window,

* [English translation rendered from the Russian.]

were provided at the base of the projectile; the hero of the novel actually does use the force of these rockets when they fall into the neutral zone where the attractions of the Moon and Earth are balanced. It was their intention, however, to propel the projectile out of the neutral zone and fall on the Moon.

Here is how Verne describes that moment:

"At the neutral point both attractions — the Earth's and the Moon's — are canceled out. Objects, then, will no longer have weight.

"At this moment it will be necessary to act.

"The conical apex of the projectile turned perceptibly to the lunar disk. The projectile had turned to a position which offered the opportunity of fully utilizing any significant movement that the impulse of rocket charge would produce.

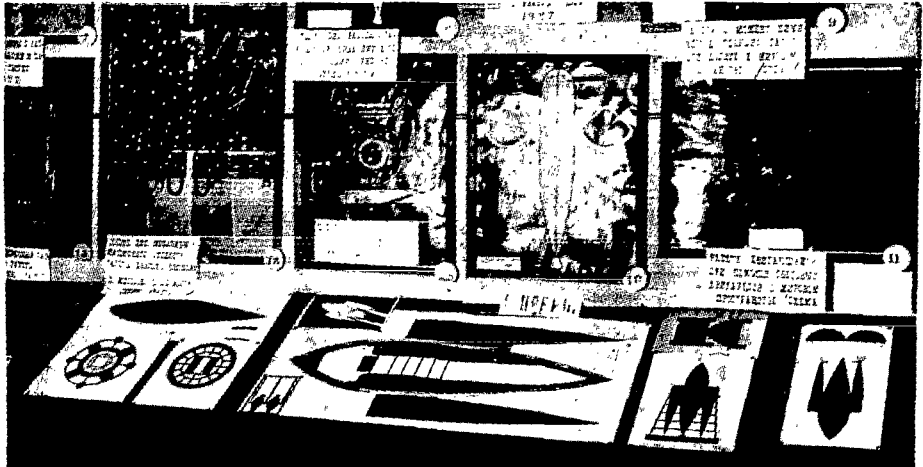

FIGURE 95. Krein's rocket [see p. 125]

"There was every indication of success. If the speed of the projectile were to be absolutely negligible on reaching the neutral point, then the slightest movement towards the Moon, no matter how insignificant, would be sufficient to induce a descent.

"The moment when the explosion of the rockets was to occur was recognized by the passengers when the sensation of gravitational force disappeared. Then Michel Ardan drew the lighted wick towards an apparatus which immediately transferred the flame to all the rockets. Because of the lack of air, no explosion followed, but Barbican noticed through the window a flame which soon died out. The ship shuddered, and this shuddering or shaking was appreciable enough (Figure 97). The travelers were silent; they looked and listened, barely drawing a breath.

"All that could be heard was the beating of their hearts.

'Are we falling?' asked Michel, finally.

'No,' answered Nicholl, 'because the bottom of the shell is not turned towards the lunar disk.'

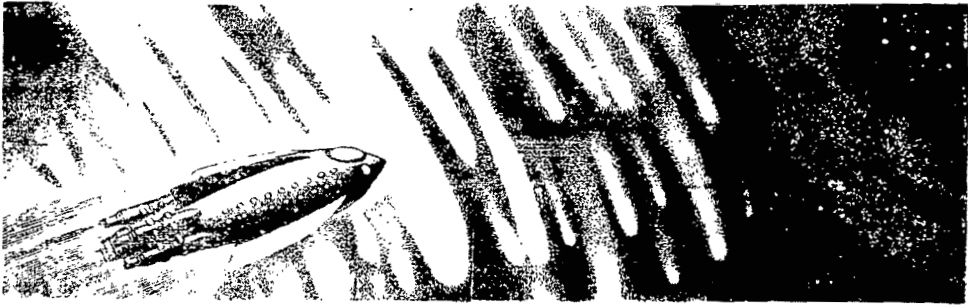

FIGURE 96. Augston's urano-ship [see p.125]

"At this moment Barbican, who had been standing near the window, turned to his companions. He was terribly pale, his forehead wore a frown, and his teeth were tightly clenched.

'We're falling,' he said

'Ah,' cried Michel, 'to the Moon?'

'To Earth.'

'What the devil!' exclaimed Michel, but then added in a philosophical tone:

'That's it. After all, when we climbed into this shell we never had much hope of getting out of it.'*



FIGURE 97. Jules Verne's rocket engine

* Flying in the shell were three travelers: Michel Ardan, Barbican and Nicholl.

"The terrible fall began. The speed which the projectile still maintained carried it away beyond the dead or neutral point. The explosion of the rockets was incapable of stopping it. The laws of physics demanded that the projectile in its elliptic orbit again pass through all those points which it had already passed. . . "

In the end, the projectile fell on Earth, into the ocean from where it emerged to the surface, and all were saved.

V. SEMENOV'S GENERATOR SHIPS

V. Semenov, in his science fantasies "Tsaritsa Mira" ["Empress of the World"] and "Tsari Vozdukha" ["Emperors of the Air"], describes new airships which gave England the chance to rule the world.

The propelling force of these vehicles was provided by a special substance, "generator." However, this substance was extremely dangerous to handle, and exploded not only from a missile falling on it but also from a jolt. For this reason it was later replaced with another, less dangerous "neogenerator". The author does not give details of the composition of these substances nor of the layout of the airship.

INTO THE UNIVERSE ON A ROCKET (A NOVEL BY O. GAIL)

In 1925 a novel was published in Germany entitled "Der Schuss ins All" by Otto Gail who had been influenced by Oberth, Goddard and Valier. The main theme of the book is a flight on a rocket from Earth to the Moon and back. The following is a condensed synopsis of the novel.

The hero is a German, August Korf by name. He is the inventor of an explosive material of unusual force — 1 kg yields 60,000 calories — of which he constructs an engine weighing less than 0.01 kg per force output. At the beginning Korf is working in India, where his assistant is a Russian girl, Natalia Skorina. A sudden explosion destroys all Korf's blueprints of his invention, and he returns to Germany. Later, he learns that an interplanetary rocket ship, in whose construction a certain Sukhinov, a Russian by birth, took an active part, has left Rumania in the direction of the Moon.

Shortly after, astronomers at the Lick Observatory observe the rocket near the Moon. Light signals coming from the rocket request help. Apparently the rocket has lost control and is now a satellite of the Moon.

Korf succeeds in collecting funds to build another rocket, which he does in Friedrichshafen, on the banks of Lake Constance. The rocket is of gigantic dimensions and consists of three rocket stages: a lower, which is propelled by alcohol and is operated at a speed of from 0 to 2 km/sec after which it falls off; then a middle rocket takes over and operates on a mixture of alcohol and hydrogen at a speed of up to 6 km/sec, after which it falls off.

Finally, the top stage, fuelled by hydrogen, is the passenger rocket. It has windows, a door, salon, cabins, bathroom, dining room, smoking lounge, electrical kitchen, and tanks containing hydrogen. Gyroscopes are used instead of compasses. There are three accelerometers to measure acceleration in flight and via this the speed. Safe acceleration is calculated to be equal to a quadrupled Earth acceleration (40 m/sec^2). At the top of the rocket there is a parachute with an area of 120 m^2 . In order to create an artificial force of gravity for the passengers inside the rocket, centrifugal motors are installed. Steering of the rocket in space is achieved with the help of three flywheels with mutually perpendicular axes.

The rocket is called "Geryon" after the mythical giant with three bodies who lived on the legendary island of Erytheia. He was killed by Hercules, who seized his cattle.*

The rocket is manned by the following personnel: two people operating the current generator, one supervising the explosions, two navigators and their relief (a total of 10 persons), then the Commander, Korf, his friend Berger, and a doctor. In addition, but unknown to them, there is Sukhinov, who has stowed away in the rocket and makes his presence known only after takeoff.



FIGURE 98. Takeoff of Gail's "Geryon"



FIGURE 99. Flight of "Geryon" in celestial space

* Gail incorrectly refers to Dante here, as if the latter during his wandering through Hell flew with Virgil on "three-headed Geryon," a monster-dragon, over the abyss. Incidentally, Dante's Geryon had only one head (see Dante's "Divine Comedy," Wolf Publ., p. 120 [Russian edition]). In another part of this book (p. 252) Dante mentions a monster with three faces, but here he is called Lucifer, not Geryon.

A rail track for the takeoff has been set up which is 12 m broad and 2 versts [2.134 km] long. At the beginning the track leads horizontally for a few hundred meters and then it has a 30% gradient. The takeoff passes off successfully (Figure 98). As the speed increases the lower and middle rockets fall off, and 8 minutes after the start the travelers are already being carried to the Moon in free flight by inertia without explosives at a speed of 9.8 km/sec (Figure 99).

Nearing the Moon, they fly around it. They are in danger here of falling onto it but Sukhinov relieves their fears by detonating the explosives and communicating to the rocket an outbound speed of 70 m/sec. Finally they spy the rocket which they are to rescue, and which is being carried around the Moon (Figure 100). They cut their speed to that of the other rocket, after which three men clad in spacesuits are sent across to it; they draw it towards "Geryon" with a wire and, at last, transfer to their craft the rocket's passenger, who turns out to be Natalia Skorina. When Natalia revives sufficiently to tell her story, they hear that while working in India as Korf's assistant, she — under the influence of Sukhinov's father — blew up Korf's laboratory and stole the blueprints from which Sukhinov built his rocket in Rumania and in which she flew to the Moon. Her supply of explosives ran low and she was in danger of losing her life. She signaled for help and then immersed herself in Yogi slumber, a secret she had learned in India. She slept up to the moment of her rescue by Korf. Her despair, and her love for Korf soften his heart. He forgives her and the two rockets, united with each other, fly back to Earth. Just before their descent, Sukhinov surreptitiously gets into the other, "his," rocket and switching on the engine flies off into space. His fate remains unknown. Korf descends safely on Lake Constance (Figure 101).

ROCKET FLIGHT TO VENUS, ACCORDING TO GAIL

In another novel, "Der Stein vom Mond" (Breslau, 1926), Gail describes new flights, in the rocket ship "Icarus," from Earth into outer space and then to Venus.

A Society, headed by the German engineer Korf, is founded to construct an interplanetary terminal station at a known distance from Earth, with which it will maintain connections through the use of electronic rockets. This type of rocket is shaped like a torpedo with retractable wings; the wing span varies from 8 to 100 m, which facilitates takeoff from and landing on water.

The interplanetary station consisted of two parts which rotated with respect to each other at a known speed in order to provide the passengers inside with the sensation of gravity, due to the centrifugal force. The large body was disk-shaped with the huge diameter of 100 m. It was made of sodium which becomes as hard as steel at a temperature of -270° , and has at the same time a small specific gravity which facilitates its conveyance from Earth.

The smaller part resembled an elongated cherry. The two parts were linked by a 16,000-m-long pipe.

At a certain distance from the station in space there was a huge light-weight mirror composed of 4,000 parts, each of which was 100 m², making up as a whole 40 hectares [1 ha = 2.471 acres]. The station was capable of turning the mirror and reflecting the solar rays falling upon it to Earth. The heat of these rays could melt polar icebergs and alter the climate of the Earth.

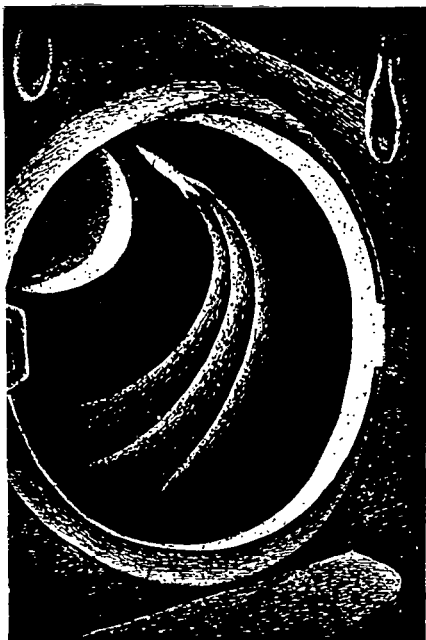

FIGURE 100. "Geryon" meets with another rocket



FIGURE 101. Descent of "Geryon" to Earth

The "Icarus" left the station and was borne in the direction counter to the motion of the Earth in order to reach Venus, near which a small satellite had been observed. The craft flew alongside the satellite and some of its passengers were transferred to the latter in a small rocket ship, 8 m long and furnished with wings.

On the satellite they found the bodies of former inhabitants of the legendary Atlantis who, when the latter was destroyed, managed to escape and fly towards Venus; but they failed to land because the ship was attracted by the satellite of Venus, where they all died.

On the satellite they noticed an unstable, undulating movement of the body, as if it were striving to land on Venus; finally, the satellite started actually falling on Venus. However, they were able to escape in their auxiliary ship, which reached the mother ship, and all returned to Earth.

The book was called "Der Stein vom Mond" ["The Moonstone"] because its heroine, Tula, a descendant of the King of Atlantis, possessed a talisman, a ring fitted with a secret stone radiating special rays. She herself was clairvoyant, could foresee the future and in a trance, perceive remote worlds.

Otto Willi Gail (Figure 102) was born in Gunzenhausen in Altmuhl on July 18, 1896. He studied at the secondary school in Augsburg and fought in World War I as an artillery officer.



FIGURE 102. O.W.Gail

After the war he studied electrical engineering and mathematics at the technical college in Munich. For lack of funds he was forced to give up his education; he became a tradesman, selling typewriters, lumber, and even opening his own company which closed down in 1924. In this year, finding himself in straits, he wrote his first novel "Mit Raketenkraft ins Weltenall," which enjoyed great success. Then followed "Der Stein vom Mond" and "Hans Hardt's Mondfahrt" (for the young).

TO THE MOON IN A HYDROGEN ROCKET

Many novelists have written of flights in rockets fueled by hydrogen. For example, Hans Dominik in his "Das Erbe der Uraniden" described the journey of five Englishmen, headed by Professor Jonah Lee, in such a vehicle from the Earth to the Moon. They reach their goal, but freeze to death due to the failure of the steam apparatus. Their bodies are brought back to England by another rocket.

BRUNO BÜRCEL'S ROCKETS

The German writer Bruno Bürgel, in his novel "Rocket to the Moon," describes two flying vehicles: one, a small ship for flight on Earth, and the other, a larger ship for flights to the Moon.

The structure of these vehicles is as follows:

The small rocket (Figure 103). The body is cigar-shaped. At the front sits the captain (1) who sees ahead through a window (9). In this compartment are concentrated the control levers: lateral equilibrium flaps (6-6), steering rudder (8), elevators (7-7), the operation of the explosive chambers (4-4) and communication with the engineer. Also in this compartment is a movable route map along which a pointer connected with the speed indicator and flight control automatically traces the part of the journey completed. The next compartment (11) is the passengers' messroom. Here there are armchairs (1) with leather pillows for the feet, a table (2), the entrance (10) and windows (9). Farther along is the engineer's quarters (III) from where he observes through special windows the operation of the automatic machine (3) in compartment IV. This machine

continuously feeds cartridges containing the powerfully explosive substance "uzambaranit" to two explosion chambers (4-4) in which the explosions occur. The explosion products fly out through two tubes located at the stern of the ship. In this manner forward movement takes place through the force of recoil of the explosion. The vehicle is maintained in the air while moving very rapidly with the help of wings (5-5). Before takeoff the vehicle is rolled along the ground on wheels.

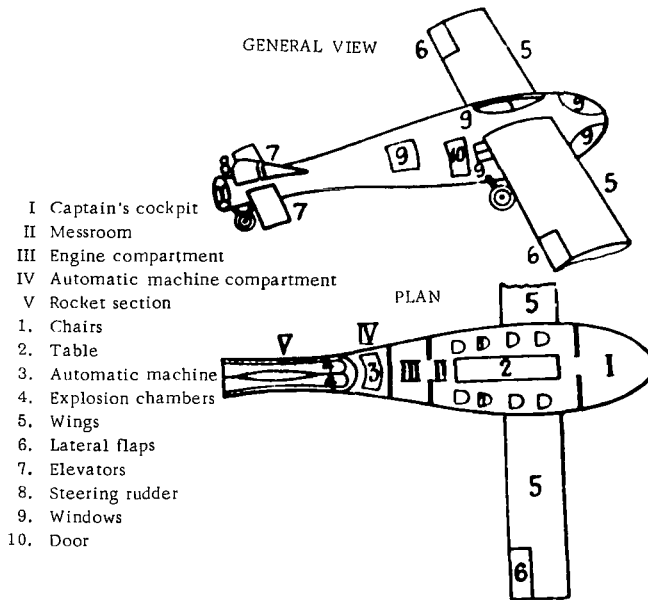

FIGURE 103. Bruno Bürgel's small rocket

Liquid helium circulates around the explosion chambers and the exhaust pipes to cool the incandescent platinum from which these parts are made. The temperature of the helium is -268° . The body and wings are made of steel. Flight speed is 530 km/hr. Flight range without descent is 8,500 km.

In outline this vehicle is an airplane with a reactive engine.

Steering to the left and right is achieved by unequal explosions in the left and right explosion chambers, while the steering rudder serves to assist the explosion effect.

The large rocket (Figure 104). Its engine is reactive. Its explosive is the same substance — "uzambaranit." Its objective is a flight to the Moon. However, in the opinion of the author, this flight is possible only because in the period described by him (3000 A. D.) the solar system and the Earth's orbit find themselves in the path of a certain nebula which the author calls

Swendengamm Nebula, after the astronomer who discovered it in the year 2211. This nebula came from outer space and filled in the solar system, forming a strongly rarefied but adequate medium for flight "on wings." That is why the author adds wings to the rocket "for support."

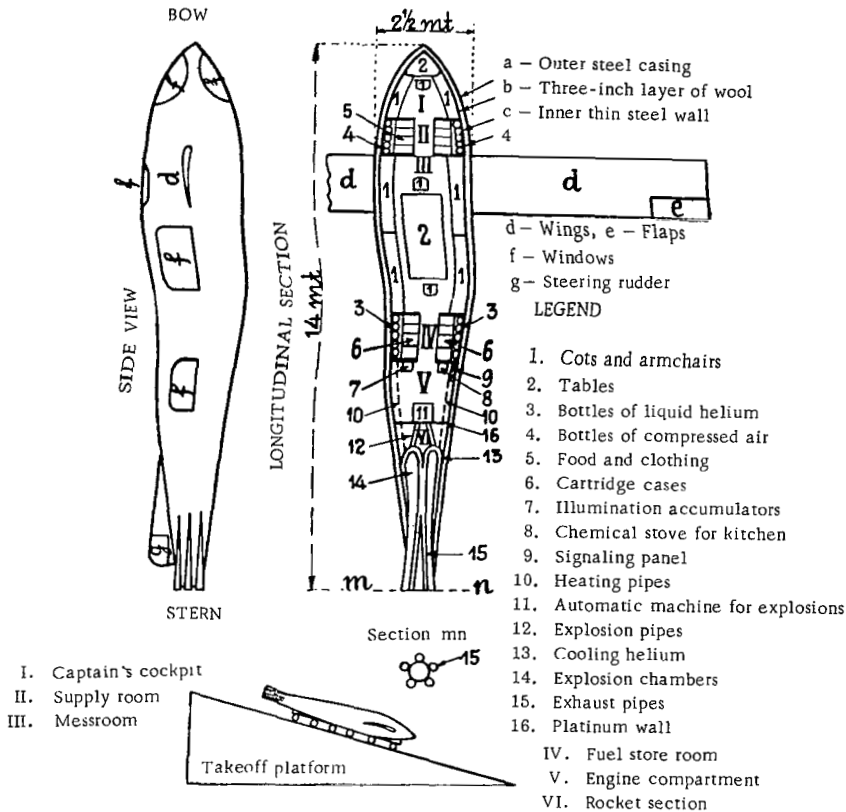

FIGURE 104. Bruno Bürgel's large rocket

The structure of the rocket is as follows:

It is divided into six sections: section I is captain's quarters. Here there are cots and an armchair (1), a table (2) and control and navigational instruments. In section II there are the supplies, including food, clothing in cases (5), steel cylinders with compressed air for breathing (4). Section III comprises the messroom with cots, armchairs (1), a table (2), closets and crystal glass windows 4 inches thick with soldered metal screens. Section IV is the fuel store room; here are found large bottles of liquid helium to cool the explosion chambers and zinc cases with cartridges of the explosive substance "uzambaranit." Section V is the engine compartment. Here there are the accumulators (7) for illumination, a chemical stove (8) for cooking, a signaling panel (9) connected with the explosion chambers and the captain's quarters, heating pipes (10) leading from

the explosion chambers, the automatic machine (11) which feeds cartridges of "uzambaranit" to the explosion chambers. Further, behind the platinum wall (16) there is section VI with explosion chambers (14); there are five in all. The automatic machine (11) feeds cartridges of "uzambaranit" along pipes (12) to the chambers (14) where the explosions occur. The products of the explosion are ejected through pipes (15). Around the explosion chambers there is a jacket (13) along which liquid helium circulates at a temperature of -268° to cool the incandescent platinum walls of the chambers and the outlet pipes.

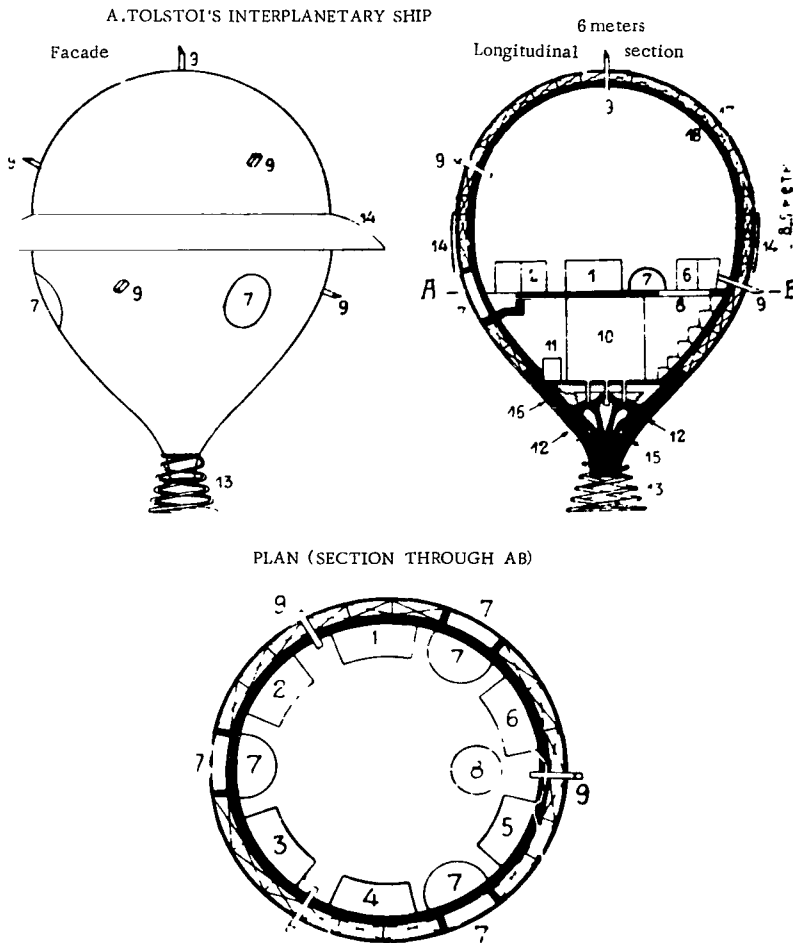

FIGURE 105. Scheme of A. Tolstoi's rocket

The body of the rocket is made of steel plate. In addition, inside the rocket there is a second lining of thinner steel. Between these steel coverings there is a layer of wool, 3 inches thick. The wings (d) are made of steel. At the ends of the wings there are ailerons (flaps) for lateral equilibrium (e—e). At the stern is the tail fin and rotation rudder (g). The major change in movement of the rocket is achieved by inequality of explosions in the five chambers, while the rudders serve only as an auxiliary means of control. For takeoff, the rocket is placed on a trolley whose wheels can roll on the tracks running along the length of the inclined steel platform. After reaching sufficient speed the rocket ascends. The crew consists of 4 persons working in two shifts; a fifth person is a passenger. The vehicle is called "Star of Africa."

In the event that the hull is pierced by meteorites, the holes can be plugged inside with lead wedges.

The fate of the vehicle flying from the Earth to the Moon, according to the author, is unknown. He theorizes that 1) it could have fallen on Earth, into the ocean and disappeared without a trace, 2) the "uzambaranit" could have exploded and reduced the rocket to dust, 3) it could have crashed on the Moon, and 4) it could have reached the Moon safely and failed to return.

A. TOLSTOI'S ROCKET

The writer Aleksei Tolstoi, in his novel "Aelita—Zakat Marsa" ["Aelita—Decline of Mars"], 1923, describes an interplanetary ship in which two of the major characters in the book leave Leningrad on August 18, 1921 for Mars and return to Earth on June 3, 1925, falling into Lake Michigan in the United States of America. The flight is based on the rocket principle.

Structure of the ship. In Figure 105 are illustrated the side view, longitudinal section and plan of the ship, and in Figure 106 the general view of its flight to Mars.

The vehicle outwardly is egg-shaped; it stands $8\frac{1}{2}$ m high and is 6 m in diameter. Around its circumference in the middle runs a steel belt (14) bent downward towards the surface of the vehicle like an umbrella. This device serves as a parachute brake increasing the resistance of the vehicle while falling in the air. Under the parachute there are three circular doors (7), entry hatches. The lower part of the egg terminates in a narrow neck. It is encircled by a double round spiral of massive steel (13), twisted in opposite directions — a buffer. The apparatus is made of soft and refractory steel, well reinforced inside with ribs and light girders. This makes up the outer hull (17). In it there is a second shell (18) of six layers of rubber, felt and leather. Inside this second leather-stitched shell are found the engines (12, 15, 16), oxygen tanks (1), cases for the absorption of carbon dioxide (2, 6), instruments (3), supplies (4), controls (5) with rheostats and two gyroscopic velocimeters. For observation purposes there are special "peepholes" (9) in the form of short metal pipes with prismatic lenses. These pipes emerge through the outer shell of the vehicle.

The engine is located inside a neck enclosed in a spiral coil. The neck is cast of the metal "obin," which is extraordinarily elastic and yet is stronger than astronomical bronze. In the interior of the neck vertical channels have been drilled. Each of these channels broadens above into a so-called explosion chamber (12). In each chamber there is a sparking plug connected by leads (16) to a common magneto (11). Fuel is supplied by feed pipes from the store room (10). "Ultralyddite," a fine powder of unusual force, is the fuel. The explosion cone is very narrow. In order for the axis of the explosion cone to coincide with the axis of the vertical channel of the neck, the "ultralyddite" enters into the explosion chambers through a magnetic field (15). The supply of "ultralyddite" was good for 100 hours. By reducing or increasing the number of explosions per second, it is possible to regulate the speed of ascent and descent. The lower part is markedly heavier than the upper, and for this reason when the vehicle falls into the region of attraction of a planet it must always turn neck forwards.

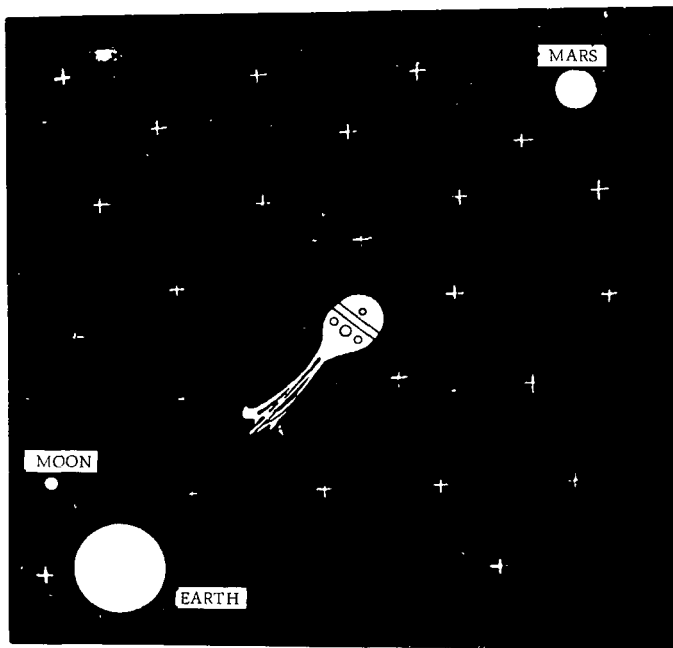

FIGURE 106. Flight of A. Tolstoi's rocket

Among the instruments there is an automatic machine which, with the help of a gyroscope, periodically replenishes the supply of oxygen and ammonium salts in the cabin for breathing purposes.

The flight, which the author calls the fall, takes place by the reaction force of an explosive substance and is effected by the rocket principle.

In airless space the rocket will move with an ever-increasing speed, which can reach the speed of light if magnetic influences do not interfere.

The course which the ship is to follow consists of three parts: 75 km of thickness of the Earth's atmosphere, 40 million km distance between Earth and Mars in airless space, and 65 km of thickness of Mars' atmosphere. In order to complete the journey of $75 + 65 = 140$ km, $1\frac{1}{2}$ hours are necessary, with an additional hour for the sphere to escape from the Earth's attraction. Finally, 6-7 hours remain for the rest of the flight. Acceleration of motion must not be excessive, otherwise the blood vessels would burst; besides this, entry into Mars' atmosphere must be slowed down, otherwise the vehicle might burn up from impact with the air.

Here is how the author describes the departure from Earth: "From the hangar there resounded a deafening noise, as if a tree had fallen. A rapid series of powerful thumps followed. The earth trembled. Above the roof of the hangar ascended a blunt nose covered by a cloud of smoke and dust. The din increased. The black vehicle hovering over the roof remained suspended in the air as if taking its bearings. The explosions fused into a steady howl, and the eight-meter egg flew up obliquely, like a rocket, over the crowds, turned to the west, left behind a fiery streak and disappeared in the dim reddish purple glow of the clouds."

Inside the vehicle the flight is described as follows: "Los (hero of the novel) took hold of the lever of the rheostat and turned it slightly. A deafening explosion was heard, at the first crack of which a shudder passed through the crowd of thousands. He turned the second rheostat. The crackling under the legs and vibration of the ship grew so powerful that Los' companion seized hold of a chair and rolled his eyes. Los switched on both rheostats. The vehicle jerked. The reports grew fainter, the vibrations diminished. The vehicle took off. The speedometer showed 50 m/sec. The vehicle rushed tangentially against the Earth's rotation. Centrifugal force carried it to the east. According to calculation, at an altitude of 100 km it should straighten and fly in a diagonal line vertical to the surface of the Earth.

"During the flight in outer space the vehicle avoided attracting the meteorites by the reaction force of the explosives. When they neared Mars the ship turned its neck to the planet. Los reduced the speed and switched off the engine and then gradually gave it retrograde pressure by means of explosions; the vehicle slowed its descent. A strong jolt caused the vehicle to turn over on one side, and then stopped on the spot."

During the return flight from Mars to Earth:

"The mammoth rusty egg, as big as a house, roared and lifted brown clouds of dust and smoke under it. The ground trembled from the terrible impacts. With a howl and a thunderous roar, the gigantic egg jumped along the field, hanging in clouds of dust and then, like a meteorite, was hurled into the skies carrying its passengers back to Earth. . .

"The globe of Earth had already covered half the sky. Los turned the rheostat to the limit. The flight was swift — the envelope became incandescent, the rubber casing simmered, the leather lining smoked. With a last effort Gusev turned the lid of the hatch. An icy wind flew in through a crack. Earth opened up her arms, embracing her prodigal sons.

"The shock was powerful. The casing broke. The egg's neck plunged deep into a grassy knoll.

"On Earth, the inhabitants of the United States of America near Lake Michigan heard a strange howling sound for a full five minutes. Then they saw a circular shadow rapidly gliding to the Earth.

"Not more than an hour later a large crowd had gathered where the vehicle had fallen. The egg, covered with a burnt crust, dented and broken, stood lopsided on the knoll. On the half-opened roof of the hatch could be seen the inscription: 'Departure from St. Petersburg on August 18, 1921.' This was all the more incredible because it was now July 3, 1925."

TRAIN AND WOOD'S REACTION SHIP

In 1917, the American magazine "Cosmopolitan" published a novel of fantasy "The Second Moon", which was written by Robert Wood, a professor of physics, and the novelist Arthur Train.

The novel describes the flight from Washington of four persons — Professor Hooker, the engineer Peakes Atterbury, the flyer Burke, and Rhoda Gibbs, a professor of mathematics — from the Earth to outer space to explode and deflect from the Earth an enormous asteroid, "Medusa," which had changed its orbit under the influence of a passing comet and now threatened to fall on Earth and cause dreadful devastation. On the way to the asteroid the travelers stop for a little while on the Moon, then discharge their task and return to Earth. Their interplanetary ship, called "The Flying Ring," is built on the rocket principle. Some data on its structure and flight (Figures 107, 108, 109) are as follows.



FIGURE 107. The Train-Wood rocket ship (below)



FIGURE 108. The Train-Wood rocket ship (above)

Principle of flight. The vehicle is propelled by the reaction of gases ejected from its combustion chamber. Inside this chamber there is a uranium cylinder onto whose lower surface special rays breaking up the uranium into atoms are directed. The atoms explode and the decomposition products in the form of α -particles fly from within with nearly the speed of light, creating a reaction which lifts the ring.

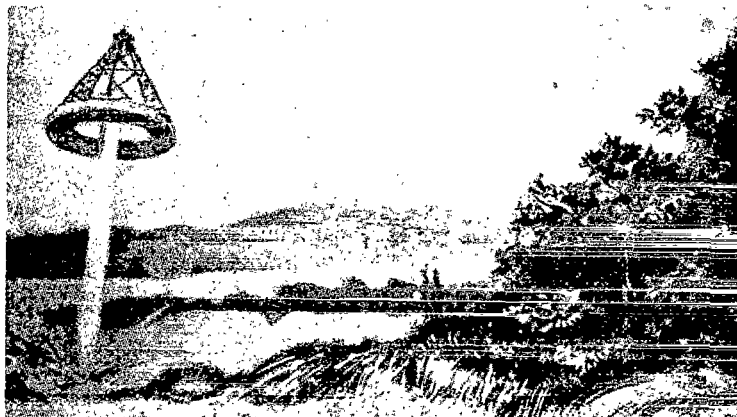

FIGURE 109. General view of the Train-Wood ship

Structure of the ring. The outer appearance is as follows (Figure 107). The lower part consists of a huge ring resembling a lifebelt, 22 m in diameter. Resting on the ring are three girders converging above and supporting a special cylindrical chamber. In this chamber are located uranium cylinders, the explosion of whose atoms furnish the reaction. A stop on the Moon was necessary in order to change the used cylinder for another. The ring is made of aluminum. It is 4.5 m high. In it are oblique pipes through which the disintegrating rays pass to the lower surface of the uranium. Inside the ring there is accommodation for passengers (Figure 108), controls, and an apparatus for producing the disintegrating rays with which Medusa is to be attacked and deflected from Earth. One uranium cylinder is sufficient for 10 hours of travel. The ring is entered through a circular door reached by means of a steel ladder (Figure 109). The doors are double, resembling an air lock, i. e., one enters a space between the doors, closes one door and then when the air pressure is equalized, the other door is opened. The doors open into the inside ring space so that the interior pressure presses them more compactly against the mortises. Inside the ring there are dynamos. A number of cabins with windows at the sides, ceiling and floor are placed around the circumference. Charts are stored in one of them. The upper cylinder containing the uranium is of a yellowish metal. Its lower end is covered by a plate of a transparent substance. It emits rays and is turned downward, but can be aimed in any direction in space by an electric motor that is controlled from inside the ring. In one of the cabins there is a complex mechanism controlling movement of the ring. A double gyroscope with 30-inch disks having mutually perpendicular axes hangs in this cabin;

it acts in a stabilizing capacity by controlling the inclination of the engine. At first the rocket ascends vertically and the flow of gas runs perpendicularly downward along the center of the machine; when it becomes necessary to fly in a horizontal direction at a certain altitude, the upper cylinder is inclined, after which the flow of gas runs in an inclined direction. The vertical component of recoil carries the ring upward and the horizontal component, forward. The gyroscopes act on the lever controlling the inclination of the engine and automatically maintain equilibrium. In the absence of such a mechanism the equilibrium would be upset each time another body came close to the ring. Inside the ring there are ropes which the passengers can grasp to direct their movements during the flight, since they are weightless and can fly. Finally, there are automatic signals that warn of the urgent need to change the uranium when the upper uranium cylinder is 90% consumed.

Fittings. Inside the ring, in the cabins, are comfortable furnishings — tables, armchairs, a small kitchen, etc. In the cloakroom there are suits of thick rubber with helmets and double-walled containers for liquid air. Fresh air inside the rubber suits is obtained by slow evaporation of the latter, and the surplus air is withdrawn through a valve. Along the cabin walls hang disks wrapped in cloth — cooling devices. The windows and walls are covered with them when the Sun starts to heat the ring.

Departure from Earth. The ring was lifted onto a wooden gantry to facilitate takeoff. In this manner a way of escape was opened for the currents of air caused by the ejection of gas from the engine. Around the vehicle a wire net nearly half a kilometer in diameter was erected. This was the danger zone, whose area had been determined on the basis of experience with previous flights of the ring.

The command came: "Start the engine."

A dull sound filled the air. A gust of wind arose from the center of the field. A weak glow could be seen at the top of the three-legged superstructure of the ring, and a yellow ray of light permeated it, brightly illuminating the wooden scaffolding. The wind rose to storm proportions; the air was filled with dust. The ground shook under the onslaught of the yellow stream that was rushing down from the cylinder with a roar like that of the Niagara Falls. Through the eddy it was possible to see the glow from the scaffolding which had suddenly burst into flames: huge logs and girders were borne into the air, the entire edifice on which the ring had reposed crashed with a roar and lay in ruins; fragments were seized and scattered by the wind encircling the airfield. The ring, having lost its support, did not fall — it hovered in the air and then started to ascend, at first slowly and smoothly, like a balloon, and then faster with the hissing of a rocket. In ten seconds it had ascended up to 30 m. A minute later it was at an altitude of 1 km. And then, higher and higher, it nearly disappeared from view, leaving behind a luminous trail like a falling star. Shortly after, its yellow trail disappeared in the direction of the Moon. The noise was barely heard. Then silence. At an altitude of 30 km the ring entered a layer of atmosphere so rarefied that sound could not be propagated in it.

In the meantime the situation inside the ring was as follows. When the command came to start the engine, the gyroscopes started to rotate smoothly. The ring shuddered. Through the window a twinkling

yellow light could be seen, and the sound of the outgoing vapor was distinctly audible. The noise of the engine increased to a deafening roar. The floor trembled. The bright light pouring in from without obscured the electric illumination inside. Outside raged a phosphorescent sandstorm. A blinding cloud of a bright yellow hue was carried away from the base of the scaffolding. The ground beneath the ring was enveloped in clouds; the vapor was pierced through with phosphorescent rays, as if from the opening of an infernal cauldron. From the rapidly rotating disks of the gyroscopes a continuous wind prevailed in the cabin. The floor shook underfoot and an ominous crack resounded from outside the walls when the girders of the scaffolding were lifted into the air. The noise intensified. The floor appeared to be sinking beneath them. The room swayed as the ring, lifted by the engine, oscillated for one or two seconds. Then the vehicle assumed a stable position; again an upwards pressure was felt from the floor and the weight of the body suddenly increased. These signs indicated that the ring was ascending. From the window it was now possible to see the blinding cone of yellow, like the tail of an enormous rocket, which the ring was emitting. Then it became possible to distinguish the expanding ring of yellow haze; bands of light and shadow alternated with each other and in the center there raged a maelstrom of dust and broken girders. The lights of the city and adjacent areas seemed to blend into one point under the ring. And then below them was a dark abyss of the disappearing Earth.



FIGURE 110. Departure of the Train-Wood ship from the Moon

Flight. At an altitude of 44 km, the sounds from outside ceased. The ring had been flying for 20 minutes and its speed was around $3\frac{1}{2}$ km/sec. According to calculations this speed could have been raised to 24 km/sec already after the course of an hour. If the engine were to have been switched off then, the inertia of movement would have carried it to a distance of 80,000 km in the course of the following hour. Most of the journey could be made on only one uranium cylinder. When the vehicle was flying at a speed of 11 km/sec, the engine was switched off. The blazing light of the helium

[α -particles] under the ring slowly faded and then disappeared. Pressure on the passengers decreased and their bodies became lighter. The ring left the Earth, maintaining a speed equal to that of the Earth's rotation around its axis plus the speed of its movement around the Sun and the intrinsic speed of the ring. During the flight the first uranium cylinder started to run low and in order to change it, it was decided to land on the Moon.

Descent to the Moon. Since the ring's apex faced the Moon, it became necessary to turn it so that its base faced it. It was decided to switch off the engine at a distance of 160 km from the lunar surface. At this time the ship was flying with a speed of 16 km/sec. The turn around could be made by inclining the upper cylinder at its greatest angle to the axis of the ring. Since the force of attraction would act very weakly on the ring, it would rotate around its center of inertia which would then bring the Moon under it. All that would remain then would be to right the engine and release full power to decrease the speed of movement.

This was done. The ring turned its base to the Moon and slowly descended. The α -particles had already started to strike the lunar surface, and raised a cloud of white haze which enveloped the ring so that nothing could be seen. Above and below the ring circled a cloud of white dust. Suddenly the ring crashed with a noise like that of a huge hammer smashing into a boiler. However, all was well.

Departure from the Moon (Figure 110). After recharging the uranium cylinder on the Moon, the travelers decided to fly on for the encounter with Medusa. The engine was set in motion. The ascent from the surface of the Moon was more difficult without the scaffolding. The ring shook with the oscillation of the motor. A dense cloud of dust surrounded them and rock fragments bombarded the lower surface of the ring. The noise increased with each second. A gigantic beam hit the lunar soil and left an enormous crater in its wake. The beam became brighter and the vehicle suddenly ascended from this chaos into the sunlight.

Since there was a new moon at that time the ring, located on the Earth's side of the Moon, was forced to fly around the satellite and then aim for Medusa, which was on the other side of the Moon.

After ascending to a sufficient altitude, Burke gradually started to incline the ring, which had to be done with great caution. The air valve controlling the inclination of the α -particles and ensuring the horizontal position of the ring at a known altitude above Earth was not suitable for the Moon, where there was no atmosphere. It became necessary to regulate the movement by eye. However, the maneuver was successful and the vehicle was carried to Medusa.

Later, there is a description of the struggle with the asteroid, which ends in success. Medusa is partly destroyed, and changing its orbit does not fall on Earth, becoming instead its second Moon.

Return to Earth. The ring flew directly to Earth which was rotating around its axis. Each point of its equator was racing at 1,600 km/hr. When they had left Earth, they had shared in the Earth's rotation around the axis. Navigating the flight in space they had taken this rotation into consideration, but now they would have to descend on the globe rotating with a speed 10 to 15 times greater than the speed of the fastest express train.

They gradually approached Earth; the ring flew in the direction of its rotation until the speeds equalized, but there was still the task of

first descending into the rotating atmosphere of Earth. The base of the ring was now turned to the Earth. It entered the outer layer of the Earth's atmosphere. A gentle murmuring sound filled the air. The sound gradually increased to a shriek, then to a din. The ring shook. The noise grew to the frenzy of a hurricane and the travelers could barely hear each other speak. They carefully descended. Little by little the ring gained the speed of the storm and rushed together with the atmosphere. It was decided to land again in Washington. The impressions of a spectator on Earth are then described.

"A distant rumbling could be heard and high above in the distance arose a huge cloud of smoke and steam. The ring was safely descending towards the Earth.

"A black spot in the sky rapidly approached and grew with each second. It was the flying ring, gleaming in the sunlight. From above could be heard a quiet and rhythmic hissing, as if steam had been released. The machine stopped moving forward and started to descend slowly. A creaking and crunching followed; a stream resembling burning steam, accompanied by a pale yellow phosphorescent light, burst over the middle of the ring and tore away the green blanket of grass, lifting into the air clouds of earthly dust and dirt. In a few minutes the noise died away, the whirlwind of sand subsided and the ship could be seen resting safely on Earth."

WORLD FIRE AND THE ETHER STATION (A NOVEL BY LAFFERT)

In 1926, in the German journal "Daheim" there appeared the novel "World Fire" by Karl Laffert. The novel was inspired by the ideas of Oberth on the possibility of building an interplanetary station in the ether and controlling the Earth's climate from there with the help of a mirror reflecting solar rays. All these ideas had been long ago given expression by K. Tsiolkovskii, but became known outside the USSR only after the appearance of Oberth's work in Germany.

Here is a brief synopsis of the novel, which takes place 20 to 30 years ahead of our time.

At the head of the administration of the entire globe was the Commission of the World League, in which were gathered the heads of all states except for Bolshevist Russia, which preserved its independence but was limited to its territories in the Far East, the capital being the city of Khabarovsk. The World League built a so-called "Ether Station" some several thousand kilometers from Earth, which housed a number of engineers who dispatched to various parts of the Earth solar rays, obtained through the action of massive mirrors, by which the climate could be regulated.

Communications between the ether station and Earth were maintained through interplanetary vehicles. As the result of accident, one of these vehicles is forced to land near Khabarovsk, where it is captured by the Bolshevist dictator Kolumin. He threatens the captain of the ship Westerkampf (a German) with death unless he repairs his own ship and builds another of the same kind with which Kolumin can fly to the ether station, overpower it and thus seize all the Earth. The flight takes place, but the

attempt to capture the station fails and the Bolsheviks are taken prisoner and later allowed to go home to Khabarovsk.

At this time the astronomers predict the imminence of an eruption on the Sun that will be so powerful that the entire central belt of the globe, though not the Polar region, will conflagrate from the burning rays of the luminary. This, in fact, takes place and a world fire starts. Thousands of cities and millions of people are destroyed. The situation is somewhat better in Europe and, in particular, in Germany which, with the help of the ether station, shelters itself from the lethal force of solar rays by a layer of clouds. Finally, the fire ends. Westerkampf takes possession of the ether station and Germany becomes the head of the World League. Kolumin and his followers take refuge from the fire in a submarine, sail to California, take over the city of San Francisco, and form a new state, independent of the League. Against the background of world events, two romances develop which end in marriage: Westerkampf marries the Bolshevik girl Lena, a former secretary of Kolumin's who has left him for love of Westerkampf, while Kolumin marries Edith, former wife of Westerkampf, who has become estranged from him.

PASSAGE OF EARTH THROUGH A TOXIC ETHEREAL FIELD

The English writer, A. Conan Doyle, in his novel "Valley of Fear," describes the possibility, in his opinion, of an event whereby the Earth, carried with the Sun through outer space, comes upon that region of the ether which is filled with substances fatal to human life. All the living beings on Earth huddle in a stupor and only a small group which had anticipated such an event and had taken supplies of oxygen escapes being poisoned. However, in 28 hours Earth emerges from the danger zone and all beings return to life.

FLIGHT OF A ROCKET FROM THE EARTH TO THE MOON AND BACK, ACCORDING TO AREL'SKII

G. Arel'skii, in "Podarok selenitov" ["Gift of the Selenites"] ("Mir Prikl'yucheni", No. 5, 1926), tells of the flight of a rocket from the Earth to the Moon in 1930. The American Society of Interplanetary Communication launches a 30-meter rocket missile, unmanned, which contains self-recording instruments.

Launched from Lowell Observatory in America, the rocket swerves from its original course of flying around the Moon and returning back to Earth, and falls onto the lunar Apennines, in the crater Conon.

Three years pass and, suddenly a piece of meteorite falls in Moscow; it proves to be a small cylinder with a message inside, saying: "The last of the Selenites are sending you a return gift." Shortly after this what appears to be a missile falls from the sky into Lake Urmia in Iran; it turns out to be the missing rocket, which the Selenites, Moon-dwellers, had found and were now returning to Earth. Since by falling on the Moon the rocket had damaged

the oxygen-generating apparatus so necessary for the remaining five Selenites on the Moon, they were doomed to death. However, before the end they manage to send the message to Earth, followed by the rocket itself.

JOURNEY TO THE MOON IN TSIOLKOVSKII'S ROCKET

The ideas of K. Tsiolkovskii are reflected in the novel "Puteshestvie na Lunu" ["Journey to the Moon"] by S. L. Grave ("Priboi," 1926). The author tells how two Russian engineers, Maleev and Basharin, together with the Young Pioneer Petya, fly to the Moon in a rocket ship, constructed according to Tsiolkovskii's scheme. The site selected for the takeoff is in Tibet (Pamir, 37°N), and the flight direction is at an angle of 10° to the normal. A special scaffolding is built for the takeoff. The rocket flies to the Moon, where it lands. The passengers, in spacesuits, explore the Moon, take photographs and then return to Earth, landing on the Caspian Sea. In order to land on both the Moon and Earth, they put to use the reaction of retrograde explosion. During the flight they maintain radio communications with Earth.

ARMFEL'DT'S WINGED ROCKET

Professor B. K. Armfel'dt of the Belorussian Academy, in his tale of fantasy "Pryzhok v pustotu" ["Leap into Emptiness"] ("Mir Priklyuchenii," No. 2, 1927), describes the future flight of a gigantic rocket with wings whose mission is to investigate the upper layers of the atmosphere. The following is a description of the structure and flight of this rocket.

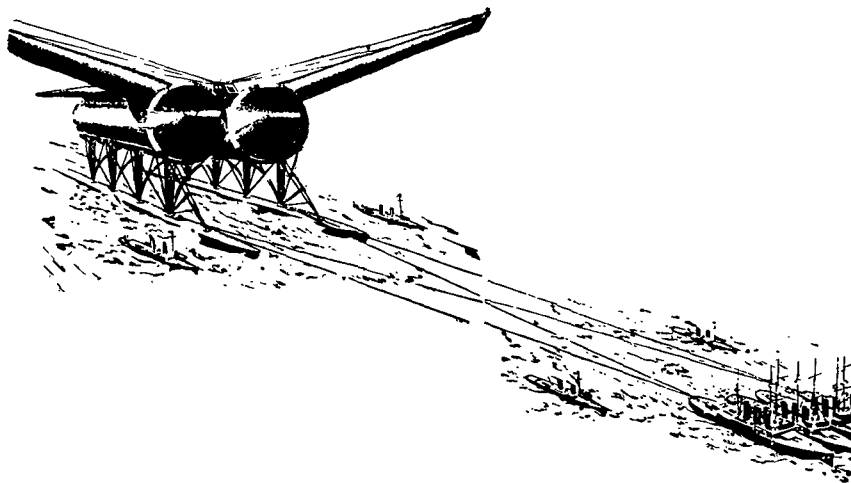

FIGURE 111. Armfel'dt's rocket

Structure of the rocket. Outwardly the rocket resembled a dragon-fly with wings spread out (Figure 111). In length it exceeded by 5 to 6 times the length of an ocean liner. Its body consisted of two long cylinders of such diameter that a large steamer could enter either one without difficulty. These two cylinders, placed very close together, were supported above the water by an entire forest of iron stays and braces attached to two long pontoons shaped like water skis. At both sides of the cylinders there stretched huge iron, canvas-covered, wing-like structures with a whole system of guide wires converging at the small closed chamber located between the cylinders at the front part of the missile. The explosive substance was a mixture of gunpowder and coal. The wings were designed to facilitate the takeoff and to lift the rocket to the extreme boundaries of the atmosphere. Beyond these boundaries the movement was to continue by inertia.

The horizontal run of the vehicle was to be made along the surface of the water.

The entire vehicle in this way represented a double or duplex rocket with wings. Special steering shields for the stream of incandescent gases, located at the exit of the rocket, steered the ship during the flight. Between the cylinders, at the front of the rocket, was a cabin for observation instruments and three passengers (the professor, his daughter, and an assistant). This room could be detached by the passengers from the missile just before its fall, and could descend with relative slowness with the help of an automatically opening parachute. Enormous gyroscopes rotated during the flight for stability.

Goal of the journey. The objective was to fly to the boundaries of the atmosphere and conduct observations on solar rays and the stars. Launched obliquely to the horizon, the rocket was to describe in space an enormous arc of a parabola, the larger part of which would be located beyond the boundaries of the atmosphere. It was to make a 3,000-km-long leap at an altitude of 500 km within 1 hour. To lessen the danger in descending, the entire flight was to be carried out above the surface of the water. Starting at the shores of France, the rocket was to end its mission somewhere along the coast of North America.

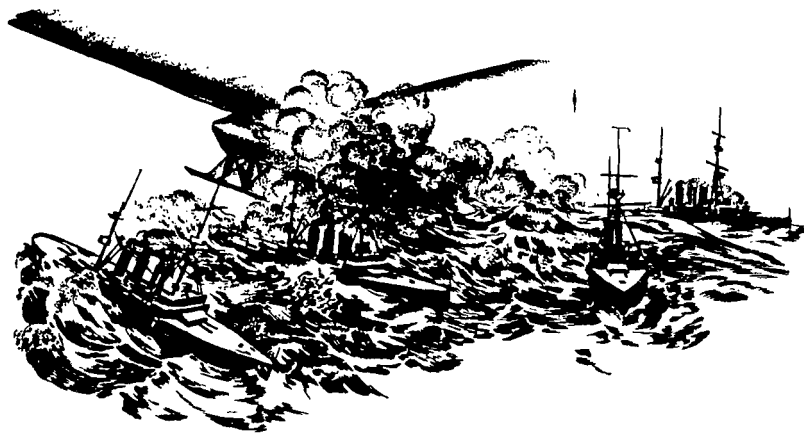

FIGURE 112. Takeoff of Armfel'dt's rocket

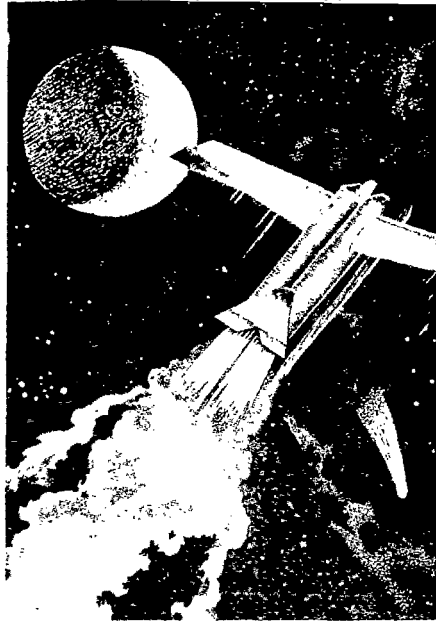

FIGURE 113. Flight of Armfel'dt's rocket

Start. Four cruisers harnessed the rocket and towed it into the open sea. When the passengers were locked in the cabin, a flame was lighted from a cruiser at the stern of the rocket and the cruiser sailed off at full speed. Suddenly the rocket trembled and rushed forward. Two huge spurts of grayish white smoke burst from its cylinders, like the eruption of a volcano. The vibration of the air was so strong that the decks and masts of the cruisers shook; the spectators were stunned by the dreadful hissing and howling although they were nearly a kilometer away from the rocket.

When they came to, the rocket was no longer visible; waves swept the sea and the cruisers were tossing about like small boats at high tide (Figure 112).

A long stream of grayish smoke lay settled on the water up to the limits of the horizon and was slowly dispersed by the wind. . .

The flight was logged by the professor's assistant from the very start. "The chamber shook and whirled. Everybody fell from the vibrations resulting from accelerated movement. This state lasted for about three minutes and then we felt free when the movement became uniform. At this time the rocket was flying out of the boundaries of the atmosphere. . . " Further on, he describes his impressions of the star sky. "These were not the soft, gentle and tender stars twinkling in our sky — these were terrible incandescent sparks. They were of every possible color: white, blue, yellow, red, and in every one of them there was concentrated a power unbearable to the eyes" (Figure 113).

The feeling of weightlessness came upon them. The professor, who was in the front cabin, was struck by the lethal rays of the Sun and without the

protection of the atmosphere was burned up alive. The rocket lost control and started to fall. The professor's daughter was blinded by the solar rays. The assistant managed to detach the cabin from the rocket and parachute down. Because of the parachute the cabin descended smoothly. It fell in the Sargasso Sea, a large tract of water in the North Atlantic Ocean. An airplane that had wandered off course picked up the assistant, but the professor's daughter died. The whole flight took half an hour.

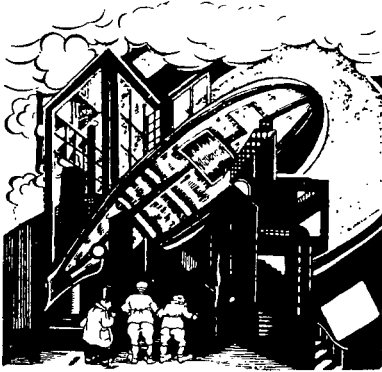

FIGURE 114. Yazvitskii's rocket

BELYAEV'S ROCKET SHIP

In the novel "Bor'ba v efire" ["Struggle in the Ether"] by A. Belyaev, an immense flying ship-city is described. Its moving force is based on the rocket principle and

the lifting force is calculated for a weight of provisions sufficient to feed the passengers for three years.

JOURNEY IN A ROCKET TO THE MOON AND MARS (BY V. YAZVITSKII)

We note a short story by V. Yazvitskii "Puteshestvie na Lunu i na Mars" ["Journey to the Moon and Mars"] which was published in 1928 in Moscow (and Leningrad). It tells of a Russian citizen, Gur'e, who dreams that he and his friend Ershov fly to the Moon and then to Mars in a rocket of the Tsiolkovskii type, which was built in America. There are descriptions of their impressions, meetings with the Martians, the fauna and flora of the Moon, etc.

THE GERMAN BUFFKE FLIES TO A PLANETOID

In the German journal "Ikarus" (Berlin, No. 8, 1927) a humorous story was published of how a certain German, Buffke by name, decides to spend the summer with his wife and two daughters on planetoid No. 2017, which is to be found between Mars and Jupiter, instead of at his summer



FIGURE 115. Buffke's flight to a planetoid



FIGURE 116. The Buffke family on a planetoid

home: The whole family climbs into the rocket ship "AE 4705" (Figure 115) and takes off on its journey. In order to navigate in interplanetary space and to find the invisible planetoid, Buffke hypnotizes his bulldog, who travels through space and guides the rocket to the Moon. Figure 116 shows the whole family on the planetoid. . . Imagine their surprise on receiving a radiogram informing them that the planetoid they had thought was theirs belonged to the "Henry Ford and Son Motor Company" and was artificially constructed, and that they must pay for the time spent on it. . .

In conclusion we present a German poem, written by Irma Gohl, which is dedicated to rockets.

WELTRAUMSCHIFF*

Auf der Rakete Feuerschwingen
Trägst du der Menschheit Sehnsuchtstraum,
Denn du wirst stolz und kuhn bezwingen
Den unbekanntan Weltenraum.

Wirst über Kosmosmächte siegen,
Du, herrlich Werk von Menschengest,
Zu unerforschten Sternen fliehen,
Wohin dein Siegeszug dich weist.

Was keinem konnt bisher gelingen,
Weil keiner Raum und Zeit begriff:
Du wirst der Erde Bann durchdringen,
Dein ist die Zukunft, Weltraumschiff.

Sept. 15, 1927

Von Irma Gohl.

* [English version appears on p.127.]

Chapter X

INHABITANTS OF CELESTIAL WORLDS

"Our Earth is a satellite of a star. As now, so in the future, we will remain citizens of the sky. Whether we know this or not, we are star dwellers."

C. Flammarion

Many writers, novelists and scientists have been preoccupied with the question of whether the other planets are inhabited; if so, what kind of people are these inhabitants, under what conditions can they live, and do they resemble the inhabitants of Earth?

The first to examine this question in greater detail from the astronomical and physiological point of view was C. Flammarion, who presented a broad picture of possible life on different planets in his book "La pluralité des mondes habités. étude où l'on expose les conditions d'habitabilité des terres célestes" (Paris, 1871). The book is composed of two parts: Part I — An Astronomical Journey in Celestial Space. Here he describes the physical, astronomical and other conditions of planets, those of our solar system as well as others, and attempts to determine the type of man inhabiting other worlds. Part II — Critical Survey of Theories, Scientific and Literary, Ancient and Modern, Concerning the Inhabitants of Celestial Worlds. Here he gives an account of the theories and fantasies of different scientists and writers from antiquity to the 19th century on the habitability of celestial worlds.

The book by Felix Linke "Die Verwandtschaft der Welten und die Wohnbarkeit der Himmelskörper" was published in Leipzig in 1925.

In this book the author, like Flammarion, investigates the possibilities of life on other planets, and after examination of the latest astronomical and physiological data comes to the same conclusion as Flammarion, i. e., there can be different living organisms on different planets that have adapted themselves to the conditions of life on these planets.

G. Kritzinger, in his article "Vom Leben im All," Pädagogische Warte, Part I, 1927, also examines the conditions of life on other planets, inquiring into the effect of gravity, the possibility of an atmosphere, temperature conditions, etc.

Professor J. Pohle, in his book "Die Sternenwelten und ihre Bewohner" (Köln, 1922), presents a series of deliberations on the possibility of life on different stars; he proceeds from the results of contemporary astronomical observations, as well as from the conditions in general of the existence of organisms, basing his deliberations on biological and paleontological data, the theories of microorganisms, physiology,

etc. Of particular interest is his account of the analyses of meteorites falling on Earth and the indication that organic substances and water had been found in their composition.

We present the opinion of Professor S. Glasenap on the question of life on the celestial worlds (preface to Professor Pohle's "Die Sternenwelten und ihre Bewohner," Köln, 1922):

"First of all, the possibility of life on the celestial worlds must be established, and then its probability investigated. The possibility of life on this or that star still does not mean that life actually exists there, and therefore the establishment of the possibility of life cannot be viewed as an answer to the question. If, on the basis of the data at hand, the possibility of life on any given star were to be acknowledged, and if, on the basis of the same data, it would be possible to come to a conclusion on the probability of life on it, for all that, the reliability of life cannot be discussed. With regard to the elaboration of the question of the details and particulars of life on this or any other planet, such preoccupations are idle since they are without any scientific basis; they are hypothetical and do not comply with the requirements of contemporary science. Under the conditions stated, the solution of the problem of life on the celestial worlds might appear to be hopeless and preoccupation with it purposeless; however, there can be no agreement with this view. Science will be equally victorious if we succeed in proving the possibility of life or, indeed, the impossibility of life on one or another of the celestial worlds. The proofs may be found in the most careful and detailed study of the celestial worlds and phenomena deriving from them."

UNDER WHAT CONDITIONS CAN LIFE EXIST ON OTHER WORLDS?

The answer to this question is difficult, since the variety of living organisms is enormous and we are far from knowledge of all the possible conditions of their existence. Various scientific investigations indicate that life may be preserved, even though without developing, under what seem, at first glance, the most impossible conditions.

We have already mentioned in this book experiments conducted to preserve the life of bacteria at a temperature of -253° .

With regard to high temperatures, experiments with plant spores (Milzbrandsporen) revealed that they can endure for 3 hours a temperature of 140° . *Bacillus vulgatus* and *Bac. mycoides* survived for a half hour in an apparatus with sterilized hot air at a temperature of $120-130^{\circ}$.

Light is not a necessary condition of life. In the depths of the Mammoth Cave in America, spiders, insects and fish live in the complete absence of light. Besides this, fish and other living organisms live in the ocean depths where light does not penetrate.

An atmosphere is necessary only where it is required for the respiratory function and the metabolic processes of animal and plant organisms. A different composition of atmospheric gases may create different conditions for the formation of organisms.

On Earth it is oxygen which is necessary for people, while for plants, nitrogen and carbon.

In examining the possible conditions for the presence of air, moisture, heat, light, gravity, etc. on different planets, we may come to a more or less probable conclusion on the possible forms of living beings and plants on these bodies.

In the table below, figures characterizing the mean temperatures (due to the Sun) on the various planets are given [°C]:

Mercury +178 (up to 332)	Jupiter - 147	} The figures given in parentheses indicate possible temperatures on the side facing the Sun
Venus + 65	Saturn - 180	
Earth + 6.5	Uranus - 207	
Moon + 6.5 (up to 106)	Neptune - 221	
Mars - 37	Sun +8,200	

Apparently, all the planets with the exception of Mercury and the Moon have an atmosphere and, possibly, moisture.

At the end of the 18th century, the question of the habitability of worlds was dealt with in an interesting manner by Bernard de Fontenelle in his "Entretiens sur la pluralité des mondes."

LAPLACE ON THE INHABITANTS OF OTHER WORLDS

Laplace, in his remarkable work "Exposition du Système du Monde" (6-th ed. Paris, 1835), expresses his opinion on the inhabitants of other worlds as follows:

"The salubrious effect of the Sun causes the development of animals and plants covering the Earth and an analogy stirs us to conjecture that it produces the same effect on other planets; it is natural to think that the matter so diversely disclosing its fertility before us is not barren on such a vast planet as Jupiter which, like Earth, has its days, nights and years, and on which are observed changes indicating very active forces. Man, who is created for the temperature he uses on Earth, could not, in all probability, live on other planets; but should there not exist an endless number of organizations corresponding to the different temperatures of the globes of this world? If one difference of elements and climates introduces so much variety into terrestrial products, how substantially must the products of different planets and their satellites differ? The most fertile imagination cannot summon up any comprehension of this; but their existence, at least, is very likely."

On the other hand the Russian writer N. Strakhov, in his "Mir, kak Tseloe" ["The World as a Whole"] (St. Petersburg, 1892), says: "it would not be out of proportion to imagine one planet patterned with life and all the others empty and silent."

Many writers* have made their heroes travel to the planets of the solar system and described their meetings with dwellers of these planets. However, as Flammarion notes, the images and characteristics of these resemble, for the most part, those of Earth dwellers, since in this context the imagination of man is dependent on ordinary earthly conceptions, and although each novelist has his own conception of inhabitants of other planets, most of them resemble those on Earth.

N. A. Morozov has beautifully described the variability of human nature under different circumstances in his poem:

WHO ARE WE?

Who are we? The likeness of people
Only to the common eye.
In the light of different rays
We are all different.

In our own consciousness
As if flashing for a moment
We drift like a mirage
Only for a moment unchanged.

We are all in cathode rays
We appear like haze
In electrogenic waves
We move unseen.

In the free world of ideas
We are as unreal as a dream.
Driven to our everlasting goal
By forces of fate.

We are all a congress of microbes
A network of temporary plasma.
Who are we? We are only a process,
Of the phenomena of elemental life.

N. Morozov, "Zvezdnye pesni" [Songs of the Stars"],
Vol. 2, p. 110

We note that some authors not only were convinced of the habitability of planets but even cited their populations. Thus, Thomas Dick, in his "Celestial Scenery" (1837), calculating on the basis of the population of England of 280 persons per sq. mile, gives the following populations for the planets and the Sun:

* Among these we will mention:

Bruno, "De l'infinito universo et mundi"
Kepler, "Somnium"
Godwin, "l'Homme dans la Lune"
Cyrano de Bergerac, "Voyage dans la Lune"
and "États et Empires du Soleil"
Kircher, "Iterexstaticum coeleste"
Fontenelle, "Entretiens sur la pluralité des
Mondes".
Huygens, "Cosmothéoros"
Holberg, "Nicolai Klimii iter subterraneum"
Voltaire, "Micromégas"
Swedenborg, "Arcana coelestia"
Wolf, "Études planétaires"
Gudin, "De l'Univers"

Anonymous, "Découvertes, faites dans la Lune par
Herschel," 1835
Edgar Allan Poe, "The adventures of one Hans Pfaal"
Boitard, "Description des planètes"
Brewster, "Il y a plus d'un monde"
Allan Kardec, "Das Buch der Geister"
Victorien Sardou, "Des Habitations de la planète
Jupiter"
Henri de Parville, "Un habitant de la planète Mars"
Victor Dazur, "Le Régiment fantastique"
Blanqui, "l'Éternité par les astres"
Vernier, "l'Étrange voyage"

Sun	681,184,000,000,000	Jupiter	6,967,520,000,000
Mercury	8,960,000,000	Saturn	5,488,000,000,000
Venus.....	53,500,000,000	Saturn's rings	8,141,963,826,000
Earth	800,000,000	Uranus	1,077,568,800,000
Mars	15,500,000,000	Moon	4,200,000,000
Vesta64,000,000	Satellites of Jupiter	26,673,000,000
Juno	1,786,000,000	Satellites of Saturn	55,417,824,000
Ceres	2,319,962,000	Satellites of Uranus	47,500,992,000
Pallas	4,009,000,000		
		Total	703,079,774,404,000

Giordano Bruno in "De l'infinito universo et mondi" describes in brilliant colors the Universe and its worlds, considering them no less populated than our world.

In 94-95 B. C., Lucretius, a philosopher of the Epicurean school, maintained that "our visible world is not the only one, and we must believe that other earths, other beings, and other people exist in space."

Celtic ballads sang of life on the Moon and other worlds, of the perpetuity of time and the endlessness of space, and that after death the soul would fly to the Sun.

The Egyptians populated the stars, planets and Moon with living creatures.

Petronius Chimera (of Sicily) stated that there were 183 inhabited worlds, basing his deduction on the premise that the whole world formed a triangle and that on each side there were 60 worlds, in addition to 3 more at the vertices.

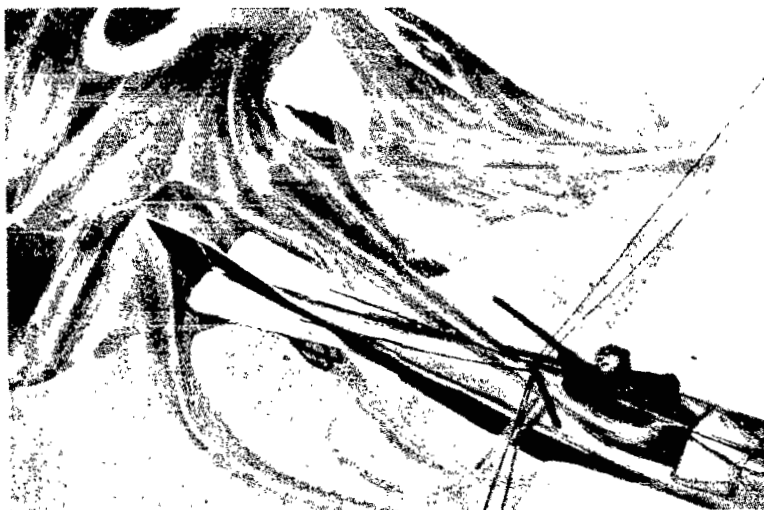

FIGURE 117. Inhabitants of the upper layers of the atmosphere, according to Conan Doyle

We note the article "Belebte Welten" by Willy Ley in which he analyzes the conditions for the formation of living beings on the different planets, the book "Planeten und Menschen" by Dr. Dekker, and the article

"Raumschiffahrtsdichtung und Bewohnbarkeitsfantasien seit der Renaissance bis heute" by Karl Debus.

Further on we shall present a series of sketches depicting the inhabitants, animals and landscapes of the different planets in the imagination of novelists.

We note en passant that before we even reach the Moon — according to the writers — we will encounter, high, high above the Earth, but still within the boundaries of its atmosphere, the inhabitants of high altitudes.

Thus, A. Conan Doyle, the English novelist, in "The Valley of Fear" populates the upper layers of the atmosphere (at 13 km) with fantastic plants and winged monsters, each occupying several hundred square feet of space. They are composed of a transparent gelatin-like substance, have two eyes and a beak, and a bag on their backs filled with gas (Figure 117).

1. THE MOON

The French astronomer C. Nordmann, in his "Journey around the Universe", expresses the following opinion on the population of the Moon:

"There is nothing which would allow us to admit of the existence of organic life on our satellite, whose surface is a thousand times more arid and barren than the Sahara. Aristo described the flowering valleys on the Moon and its population of dancing nymphs. Unfortunately, we must disenchant ourselves, if only for the fact that nymphs who can live without air do not exist."



FIGURE 118



FIGURE 119



FIGURE 120

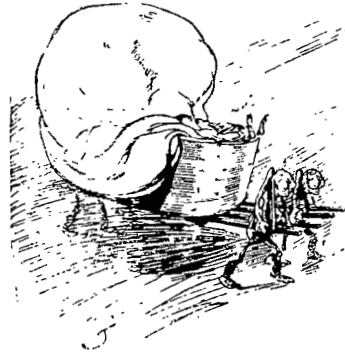

FIGURE 121

In his writings, Cicero recalled that a disciple of Pythagoras asserted that there were mountains, people and cities on the Moon.

Lucian of Samosata in his "Journey to the Moon" described hippogriffs, riders mounted on winged three-headed monsters whose wings were larger than the sails of a ship.

Further, in telling of the battle between dwellers of the Sun and Moon, Lucian classified the warriors of both sides: for example, the hippomirmecci (mounted on ants) and the tritonomendetti (with cats' paws), etc.

Dante in his "Paradise" (1300) populated the Moon with the souls of those who had sworn virginity but had broken this vow through no fault of their own.

In the 17th century, David Fabricius maintained that he had seen with his own eyes dwellers of the Moon. Others believing in the habitability of the Moon included such as Otto von Guericke, Pierre Gassendi, Archbishop Wilkin, and others.



FIGURE 122. Selenites with trunks, according to Goncharov ("Psycho Machine")



FIGURE 123. Selenites, according to Le Faure and Graffigny ("Journey to the Moon")



FIGURE 124. Selenites, according to Raspe (Baron Münchhausen)



FIGURE 125. Selenites, according to Cyrano de Bergerac (walking on all fours)

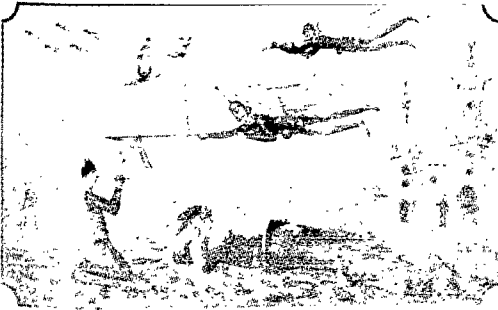

FIGURE 126. One-eyed Selenites, according to Avery



FIGURE 127. One-eyed Selenites (Cherry)



FIGURE 128. Selenites, as seen in the telescope by Herschel's son (according to Flammarion)

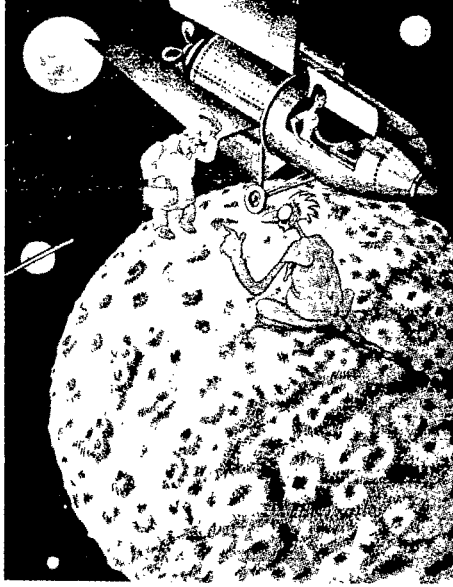

FIGURE 129. Caricature of Moon dwellers (from the journal "Krokodil")

We have more portrayals of Moon dwellers than of any others. Figures 118—121 show the selenites as visualized by Wells ("The First Men in the Moon"): ordinary inhabitants, warriors, fishermen and a scientist.

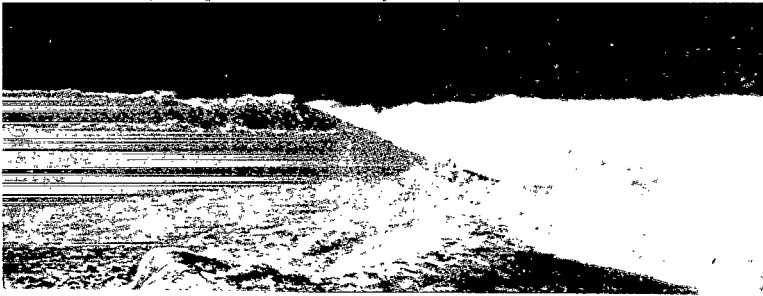

FIGURE 130. Moon landscape (according to Flammarion)

ANIMALS OF THE MOON, ACCORDING TO YAZVITSKII

In his story "Puteshestvie na Lunu i na Mars" ["Journey to the Moon and Mars"], V. Yazvitskii describes the flora and fauna of the Moon, on which,

he claims, there are air and water. Figure 131 shows lunar hedgehogs and water snakes which live on the surface during the lunar day and at night creep into their burrows.



FIGURE 131. Lunar hedgehogs and water snakes



FIGURE 132. Animals on the Moon (Avery)

INHABITANTS OF THE PLANET LILLIPUT

Oskar Hoffmann, in his "Mack Milfords Reisen im Universum," describes the inhabitants of the second (?) satellite of Earth — Lilliput. On this planet there are air, water, plants and anthropoid apes, people, serpents. . .

2. MERCURY

In his "Paradise," Dante stated that on Mercury there lived the souls of those Earth dwellers who had achieved glory for their charitable acts.

According to Radley, civilized giants populate Mercury.



FIGURE 133. Plant-Man and Guitar-Man
Inhabitants of Mercury, according to Goldberg (1741)



FIGURE 134. Inhabitants of Mercury, according to Lyakide



FIGURE 135. Bird on Mercury, according to Le Faure and Graffigny

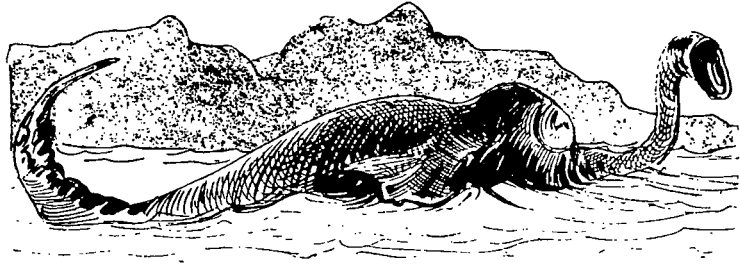

FIGURE 136. Fish on Mercury, according to Le Faure and Graffigny

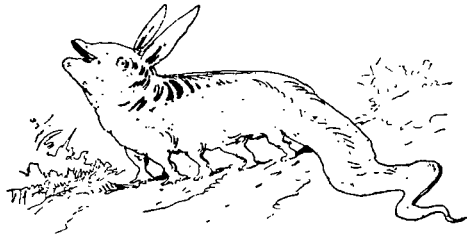

FIGURE 137. Rabbit on Mercury – Le Faure and Graffigny



FIGURE 138. Landscape of Mercury – Le Faure and Graffigny

3. VENUS

According to Dante ("Paradise"), on Venus there are souls resembling light, who fly swiftly.

The French novelists Le Faure and Graffigny in their "Aventures extraordinaires d'un savant russe" describe two types of inhabitants of Venus:

"One of them (Figure 139) resembled the inhabitants of the country of the pyramids (Egypt): an oblong face, framed by a thick, black, fastidiously curled beard, completely bald pate, fiery black eyes — in short, the whole type confirmed the resemblance. They were clad in short tunics and their red boots resembled ancient buskins.



FIGURE 139. Dwellers of Venus, according to Le Faure and Graffigny



FIGURE 140. Dwellers of Venus, according to Le Faure and Graffigny

"The other type was akin to neither man nor animal (Figure 140). In outline of figure these creatures resembled man, but instead of human skin they were covered with a kind of sealskin; the legs terminated in flat circular webs like those of a duck; long muscular hands reached almost to the knees; their fingers and toes were webbed; on their shoulders rested a round head with large eyes and a broad mouth from which there protruded sharp white teeth; they had auditory membranes instead of ears."

Radley ("The Green Machine") says that Venus is inhabited by flying creatures whose body structure is like that of the salamander. They have their own civilization.



FIGURE 141. Landscape of Venus, according to Lyakide



FIGURE 142. Dwellers of Venus, according to Bernardin de Saint Pierre

4. MARS

Dante ("Paradise"), journeying through the sky with Beatrice, comes upon the fifth heaven where Mars is found. The souls populating the planet are of an indescribable beauty and, in grouping together, form a huge cross with the image of Christ.

The Danish writer, Sophus Michaëlis, in his "Himmelskibet" writes of the inhabitants of Mars, people and animals.

"The people of Mars were like earthly people — two-legged and two-armed, with a vertical stance and pale, beardless faces. Their leader had a regular and noble skull, with a high, convex forehead above browless eyes and a look in his amber eyes that bespoke of a huge inner force. It was the face of an old man with fine network of wrinkles, lips as thin as a knife-blade, and deep grooves running along both cheeks from the very wings of the slender aquiline nose, which perpetually quivered. These people had almost no language and communicated their thoughts by looks and mimicry. The women of Mars were miniature and of an extraordinarily delicate structure. Such chiseled, slender, graceful and fragile figures were met on Earth only among the blue-blooded aristocrats. All had delicate white faces and a skin that was nearly transparent. Their eyes were hazel and literally permeated by the Sun. Thick black or dark-chestnut hair lay like a mantle over their shoulders and back. The Martians traveled for long distances on flying animals, resembling birds. These had a red beak, feathers, short claws, large wings, and fanlike tail. For movement over land they also rode on birdlike, two-legged animals such as ostriches or two-legged giraffes. In the air there flew birds and bats; in the sands lived beetles."



FIGURE 143. A Martian, according to Le Faure and Graffigny

V. Ushinskii, in his short story "Nevedomyi mir — Mars i ego zhiteli" ["The Unknown World — Mars and its Inhabitants"] (St. Petersburg, 1897), describes the Martians through the lips of a demented astronomer thus:



FIGURE 144. A Martian, according to Parville (brought to Earth on an aerolite)

"They are spirits. Their bodies have the specific gravity of hydrogen and they are as transparent as a mist."

According to Ridley, Mars has a varied population.

"The highest culture on Mars has been achieved by giant ants around 11 feet tall. They walk on two legs like man and in body structure are like the ants on Earth. Encircling their head are a large number of eyes, although they cannot see (blind). They "see" with a different kind of organ. In addition to this, they are endowed with the gift of telepathy and can transfer their thoughts to each other. They live in well-built cities, have a communications system, and can even fly to the neighboring planets. On Mars there also live: 1) huge animals resembling bats and prehistoric dinosaurs, 2) monsters which look like both bears and gorillas, 3) animals which represent something between a dragon and a bear, with the dimensions of half a dozen elephants (40 feet tall, 20 feet in diameter), 4) monster marsupials. All these inhabitants of Mars are blind.

In the novel "Fiery Ring," Maral-Vigée describes Martians who in outer appearance are quite like people, but whose culture is incomparably higher.

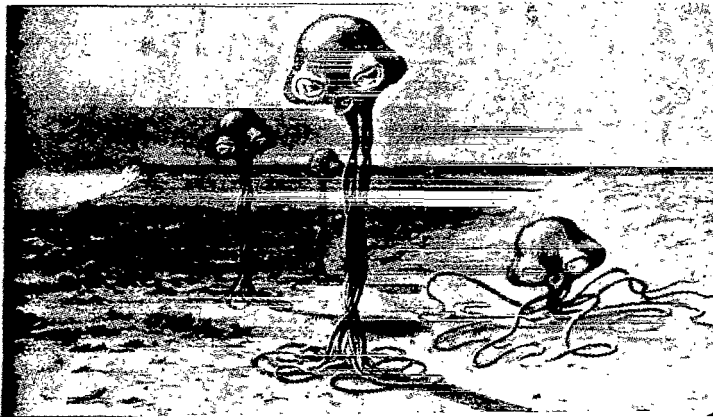

FIGURE 145. Martians, according to Wells

V. Yazvitskii in his "Puteshestvie na Lunu i na Mars" ["Journey to the Moon and Mars"] (Moscow, 1928) writes that the Martians resemble people but are covered with elephant skin; their bodies are wrinkled, and facially they resemble frogs with bulging eyes (Figure 147).



FIGURE 146. Martians, according to Augston

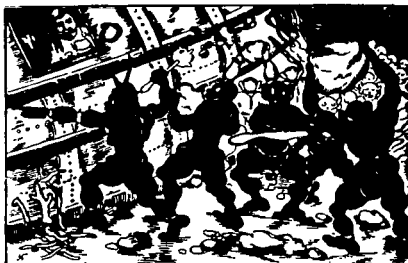

FIGURE 147. Inhabitants of Mars, according to Yazvitskii



FIGURE 148. Inhabitants of Mars, according to Flammarion

5. JUPITER

On Jupiter, says Dante ("Paradise"), live the souls of those who correctly administered justice on Earth. Grouped together, these souls form the shape of an eagle.

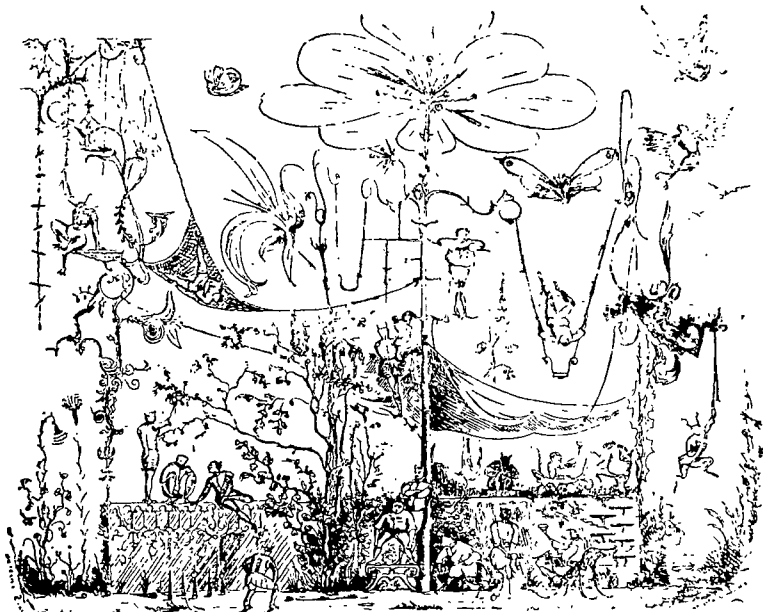

FIGURE 149. Inhabitants of Jupiter, according to Dante



FIGURE 150. Animals on Jupiter

6. SATURN

On Saturn, tells Dante ("Paradise"), there live the souls of those inhabitants of Earth who led a meditative way of life.



FIGURE 151. Inhabitants of Saturn, according to Avery



FIGURE 152. Animals on Saturn, according to Avery

In the novel "Fiery Ring", by Maral-Vigée (1922), there is a description of the inhabitants of Saturn, who resemble people but of the pastoral era of Earth. Besides this, in the opinion of the author, Saturn is populated by monstrous animals who look like the extinct ichthyosaurs, plesiosaurs, etc.

7. URANUS

The inhabitants of Uranus, according to Ridley, are highly civilized. They have a comparatively small body and a huge head. At one time they had migrated to Mars but could not endure its climate so they returned to Uranus.

8. NEPTUNE

According to Radley, only gigantic monsters resembling hippopotamuses and sea serpents live on Neptune.

9. UNKNOWN PLANET

A. Bobrishchev-Pushkin, in his story "Zaletnyi gost" ["The Flying Guest"] ("Mir Priklyuchenii," No.1, 1927), gives a picture of an inhabitant of another planet who by chance fell to Earth. There was not the slightest bit of growth on his head. His skull was pointed and very developed; when he slept his arms and legs were wound above his head. But in general he very much resembled man. At will he could surround himself with a special impermeable atmosphere in which he could be carried in outer space by the energy concentrated in pocket devices.



FIGURE 153. Animals on Saturn, according to Astor.

He had fallen on Earth because one of his devices had been damaged. Once, when he lay asleep, an inquisitive bystander unscrewed one of the bolts of the device, creating a dread wind which laid the country waste and bore the traveler into space.

10. INHABITANTS OF PLANETS

In his story "Nevidimki" ["The Invisible Beings"] ("Mir Priklyuchenii," No. 9, 1926), N. Kopylov describes the microscopic inhabitants of another planet brought to Earth by a falling meteorite. These living things were visible only under a powerful microscope. Their mental

faculties had been developed at the expense of the physical and, as a result, with the exorbitant development of the thinking organs the physical faculties of the body had atrophied. Their legs were small appendages with weak feet, but their arms revealed that physical labor was not unknown to these strange creatures.



FIGURE 154. Ghosts on Saturn, according to Astor

Briefly, these invisible beings were trunkless and looked like small globes, i. e., a head from which there grew arms and legs.

However, their ignorant neglect by people led to their extinction and the mystery of their origin was never solved.

11. INHABITANTS OF THE ASTEROIDS

Ray Cumplings, in his story "Man on a Meteor" ("Mir Priklyuchenii," Nos. 2—5, 1925), describes how the hero of the tale, Nemo, who came upon a small meteor, encountered a special type of people, "marinoids" (Figure 155). They were about 5 feet high, had two legs with the feet joined by a dangling web, and four hands (two at each shoulder). Their hands twisted in the water like the tentacles of an octopus and terminated in slender fingers with huge claws like a crab. These people, like the electric eel, were able to defeat an enemy under water by sending electrical discharges.

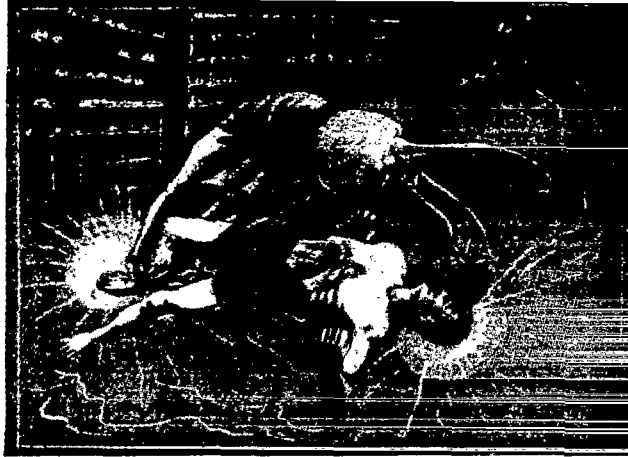

FIGURE 155. Inhabitants of the asteroids

According to Radley, one may see on the asteroid Ceres the ruins of city walls, majestic towers and temples, among which there are monstrous mushrooms and huge snakes.

12. THE SUN

With respect to the Sun, one hundred years ago Herschel declared that it was habitable, and quite recently Arago said that it was suitable for life.

"If someone were to ask the question: is the Sun inhabited?" stated Arago, "I would reply that I do not know, but if someone were to ask me if it could be inhabited by organisms similar to those populating our Earth, I would without hesitation give an affirmative reply." Flammarion, quoting this statement, noted that Arago would think twice now about making such an assertion.

Cyrano de Bergerac populated the Sun with animals whose life span varied from 7 to 8 thousand years.

Figure 156 shows the inhabitants of the Sun, according to Cyrano de Bergerac.

In the opinion of Cardinal Nicholas of Cusa, which is expressed in his "*De docta Ignorantia*" (1440—1450), the Sun dwellers in outward appearance are radiant and glittering, and are far more developed than the inhabitants of the Moon or Earth.

13. THE CONSTELLATION GEMINI

Dante ("Paradise"), journeying through the heavens with Beatrice, comes upon the constellation Gemini where he sees Christ, the Virgin Mary, the apostles, Adam, and others.

INHABITANTS OF THE ANDROMEDA NEBULA

Fritz Gremer in his novel "The Andromeda Nebula" describes the inhabitants of the planet "Drom" of this system, who resemble Earth people but are much more handsome. They do not speak to each other but express their thoughts by looks and body movement.



FIGURE 156. An inhabitant of the Sun

URANIDES

Hans Dominik, in his novel "Das Erbe der Uraniden" (1928), described how the Uranides — dwellers of a planet from another solar system — flew to Venus in a cosmic ship. In appearance they were like the people of Earth, but they were more civilized. They were forced to land on Venus because their ship had developed trouble. By means of radiation signals they informed Earth of their arrival on Venus.

By accident they ate some poisoned fruit and died. However, before the last of them perished, an electronic ship, piloted by its captain Gorm, arrived from Earth and the captain was able to record the last testament of the Uranide in which he placed at Gorm's disposal new powerful forces for flight to other solar systems.



FIGURE 157. Inhabitant of a remote nebula

14. INHABITANTS OF A REMOTE NEBULA

In Figure 157 is shown a creature who has flown to Earth from a remote nebula. Here is how Volkov, the author of the novel "Chuzhie" ["The Foreigners"] (see "Mir Priklyuchenii," No. 2, 1928), describes it:

"The creature had the head of a monster on a human trunk. His eyes, as large as saucers, occupied nearly his whole face. His mouth was enormous, his neck like that of a lizard. One nostril. The fingers of his hands were smooth, worm-like, resembling the green feet of a frog."

Finally, we note the ingenious astronomical humoresque by D. Pankov "Po Planetam" ["On the Planets"] ("Mir Priklyuchenii," No. 5, 1928), in which he settles the different planets with people and animals like those on Earth, but with characteristics that are peculiar to each planet.

On the Moon, the populace suffers from colds and coughs because of the sharp change in temperature on the sunny and shadowed sides. On Mercury the inhabitants suffer from burns and blisters because of the terrible heat. On Venus people walk about naked, in rubber boots and under umbrellas because of the constant rain. On Mars they fly through the air and maintain communications with Jupiter, Saturn and the Sun. On Jupiter people are like athletes, with highly developed muscles at the expense of mental development. They need this strength in order to overcome the tremendous gravitational force on this planet. On Saturn people swim about in a liquid which covers the entire surface of the planet (density one and a half times less than that of water). On Neptune the inhabitants are always asleep, because it is always night, the planet lying far, far away from the Sun. Finally, on the Sun, all the people and animals can only crawl and the trees trail along the ground because of the tremendous gravity.

FLIGHT INTO ETERNITY*

Were we to master that boundless wilderness
Pass the azure stars of the Dipper
And reach the fathomless depths of the heavens
Then we, dumbfounded, would there perceive:
Like a ship floating in the endless sea
That tiny star, the phosphorescent atom, growing in cosmic space
To become one day a majestic luminous body.

V. Hugo

THE GREATNESS OF THE WORLD

(by Friedrich Schiller)

Whom the creative spirit once struck out of chaos,
Through the suspended world I fly the flight of the wind,
 Until I land
 On the shore of its waves,
Drop anchor where no breeze now blows
And the cornerstone of creation stands.

* [Rendered from the Russian translation]

I saw already youthful stars arise,
And walk their millennial course through the universe.
I saw them playfully run
After alluring goals;
My glance cast searchingly about,
Saw the expanses already void of stars.

To urge the flight onward to the Empire of Naught
I steer more daringly away, take wing on the light,
Foggy and dim
Sky passing me by
World system, floods in the creek,
Eddy after the Sun wanderer.
Behold: a lonely pilgrim hurries along the path
Toward me – Stay! Wanderer, what do you want here?
My paths
To the shores of his world!
Sail hither, where no breeze now blows
And the cornerstone of creation stands!

"Halt! You sail in vain – infinity in front of you?"
"Halt! You sail in vain – pilgrim, also behind me.
Lower your feathers, eagle thought!
Bold sailorwoman, Fantasy,
Drop a dejected anchor here!"

LANDSCAPES OF THE DIFFERENT PLANETS

J. N. Miller, in the journal "Science and Invention," March, 1928, gives a number of descriptions of landscapes of the planets – the Moon, Mercury, Venus, Mars, Jupiter, Saturn, Uranus and Neptune.

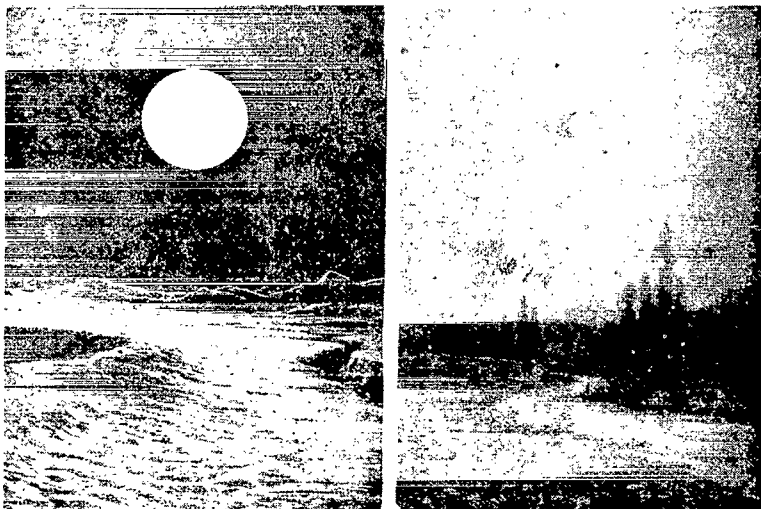

FIGURE 158. A view of Earth from the Moon and a view of the Moon from Earth

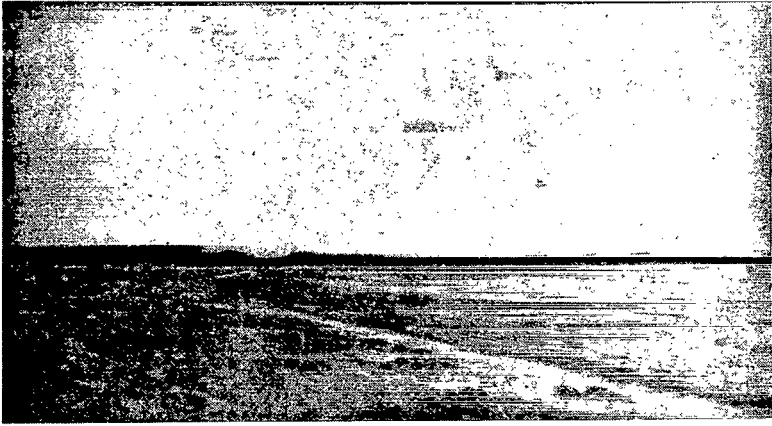

FIGURE 159. Mars and its two moons; Earth is seen in the shape of a star (right)

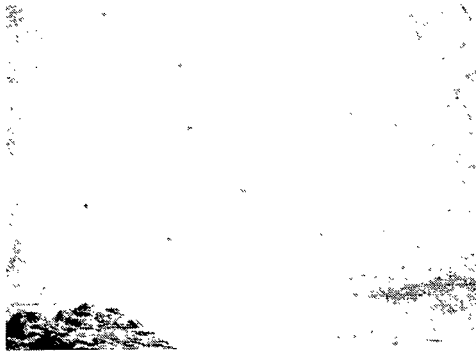

FIGURE 160. Landscape of Venus, with its clouds

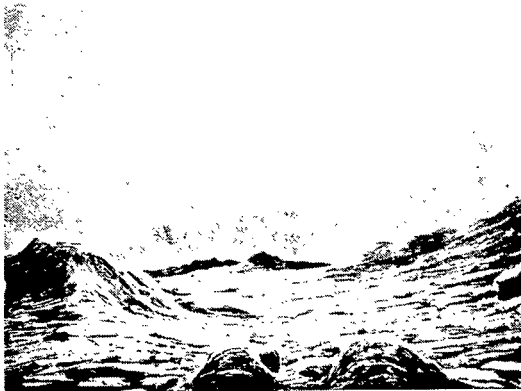

FIGURE 161. Landscape of Mercury, its soil scorched by the Sun

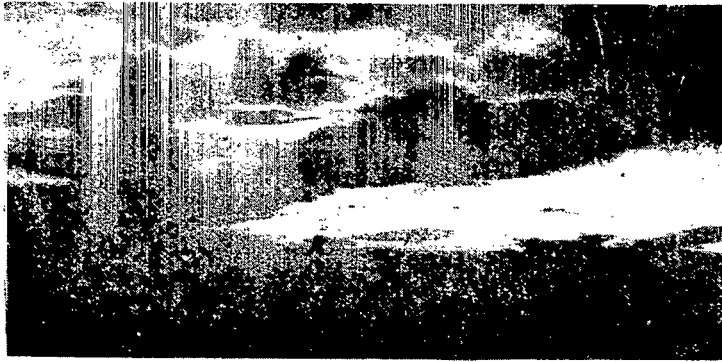

FIGURE 162. The sky of Jupiter with its satellites

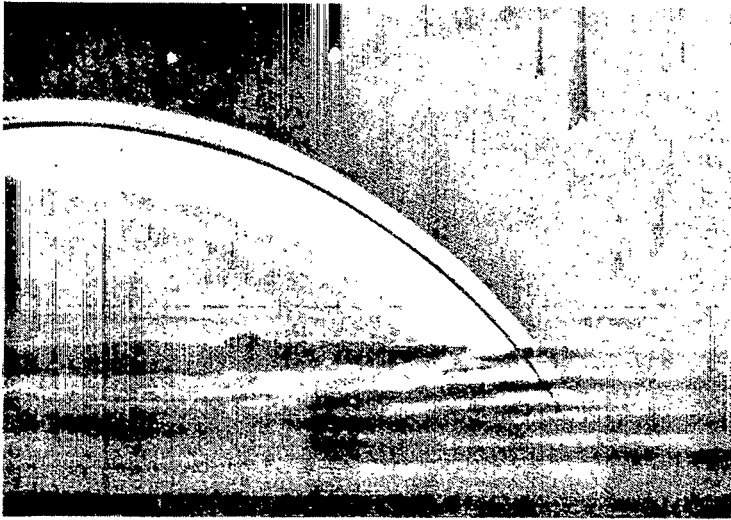

FIGURE 163. The sky of Saturn with its moons and ring

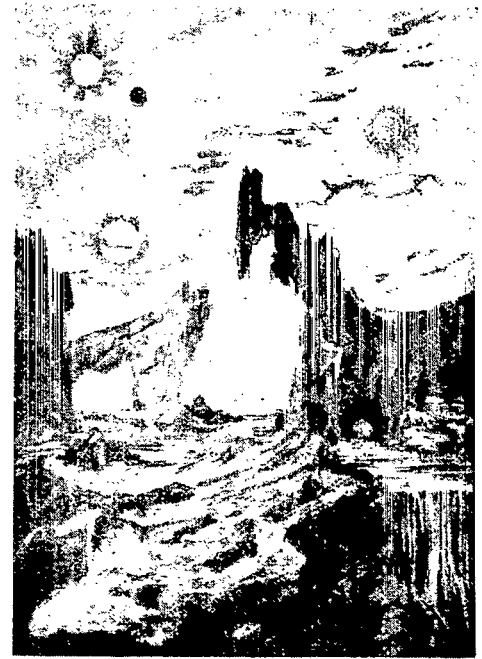

FIGURE 164. Landscape of a planet of another system, illuminated by four (colored) suns and four moons (according to Flammarion)

CONCLUSION

In this book the reader has been treated to descriptions and projects of various spacecraft proposed by different novelists and utilizing various modes of propulsion. Which of these modes deserves preference, which of them is the most credible and will enable us to fly in outer space? It is difficult to offer a definite answer. Only one thing may be said at this point, and that is that many scientists are working on the "rocket" principle and have produced a number of interesting research findings which indicate the possibility of flying, at least to the Moon, in a vehicle propelled by the reaction of explosive substances.

However, we must not rule out the possibility of applying some other principle, for example, the launching of a missile into outer space by a shot from a gun, and then switching over to a reaction engine for propulsion. Further, radio engineering has not said its last word in the context of the transmission of energy at a distance; it may be that "Yamato's ships" will fly from Earth into outer space.

The work of the physicists and chemists on the structure of matter and the splitting of the atom may open new horizons in the application of intra-atomic energy. Finally, the study of the nature of gravity may show how to counteract it.

We shall continue to hope that gravity, like an illness, will find medical treatment, which the novelists call minus or plus matter, and that sooner or later man will pierce the two armors forged around Earth — gravity and resistance of the atmosphere — and be carried high into boundless outer space.

In the next book "Mezhplanetnaya luchistaya energiya v fantaziyakh romanistov" [Radiant Energy: Science Fiction and Scientific Projects], fantastic projects of communication, telegraph and telephone between the planets will be paraded before the reader; there will be descriptions of the bold methods of changing the movement of the planets and even of their destruction and, finally, some calculations which provide the basis for an attempt to determine during which epoch people of the Earth will migrate to other planets.

National Aeronautics and Space Administration

WASHINGTON, D. C. 20546

OFFICIAL BUSINESS

Penalty For Private Use, \$300.00



POSTAGE AND FEES PAID
NATIONAL AERONAUTICS AND
SPACE ADMINISTRATION

006 001 C3 U 30 720121 S00903DS
DEPT OF THE AIR FORCE
AF WEAPONS LAB (AFSC)
TECH LIBRARY/WLOL/
ATTN: E LOU BOWMAN, CHIEF
KIRTLAND AFB NM 87117

Printed in Jerusalem, Israel

TT 70-50112
NASA TT F-641