

30 APRIL 1967

Technical Library, Bellcomm, Inc.
MAY 18 1967
LMSC-A847942

Study of Mission Modes and System
Analysis for Lunar Exploration

MIMOSA

FINAL REPORT

RECOMMENDED LUNAR EXPLORATION PLAN

MIMOSA Technical Report - Vol. III

(NASA-CR-123834)	STUDY OF MISSION MODES AND SYSTEM ANALYSIS FOR LUNAR EXPLORATION. (MIMOSA). MIMOSA TECHNICAL REPORT, VOLUME 3: RECOMMENDED LUNAR (Lockheed Missiles and Space Co.)	30 Apr. 1967	163 p	00/99	N72-75117	Unclas	37151
------------------	--------------------------------------------------------------------------------------------------------------------------------------------------------------------	--------------	-------	-------	-----------	--------	-------

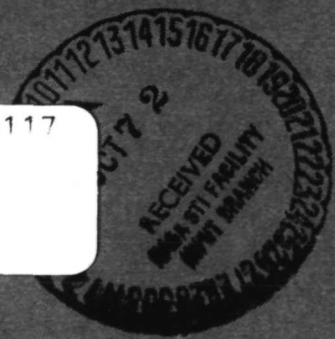

LOCKHEED MISSILES & SPACE COMPANY
A GROUP DIVISION OF LOCKHEED AIRCRAFT CORPORATION

30 APRIL 1967

LMSC-A847942

**Study of Mission Modes and System
Analysis for Lunar Exploration**

MIMOSA

FINAL REPORT

RECOMMENDED LUNAR EXPLORATION PLAN

MIMOSA Technical Report - Vol. III

Prepared Under Contract NAS 8-20262
for
**GEORGE C. MARSHALL SPACE FLIGHT CENTER
HUNTSVILLE, ALABAMA**

LOCKHEED MISSILES & SPACE COMPANY
A GROUP DIVISION OF LOCKHEED AIRCRAFT CORPORATION

FOREWORD

This document is Volume III of the MIMOSA Technical Report, which constitutes part of the final report on the Study of Mission Modes and Systems Analysis for Lunar Exploration (MIMOSA). This study was conducted by the LMSC MIMOSA team for the George C. Marshall Space Flight Center under contract NAS 8-20262. The entire final report covers work performed from 3 January 1966 to 3 February 1967 and comprises the following parts:

- MIMOSA Summary Digest
- MIMOSA Summary Technical Report
- MIMOSA Technical Report:
 - Volume I - Lunar Exploration Equipment and Mode Definition
 - Volume II - Candidate Lunar Exploration Programs
 - Volume III - Recommended Lunar Exploration Plan
- MIMOSA Planning Methodology:
 - Volume I - Planners' Handbook
 - Volume II - Exploration Equipment Data Book
 - Volume III - Scientific Programs

ACKNOWLEDGEMENTS

The Study of Mission Modes and Systems Analysis for Lunar Exploration (MIMOSA) was conducted by the MIMOSA team for the George C. Marshall Space Flight Center under contract NAS 8-20262. The contractor team consisted of the following organizations:

- Lockheed Missiles & Space Company. Prime Contractor
- AiResearch Manufacturing Company. Environmental Control and Life Support System
- Bell Aerosystems Company. Lunar Flying Vehicles
- Bendix Corporation, Aerospace Systems Division. Lunar Roving Vehicles Definition and Contributions to Scientific Program Formulation
- General Electric Company, Missile & Space Division. Electrical Power Systems

The technical management of the study was conducted by a government team composed of several organizations and their selected representatives. The Technical Supervisor and Contracting Officers' Representative for the National Aeronautics and Space Administration was David Paul 3rd, of the Advanced Systems Office, Marshall Space Flight Center (MSFC). Contributing organizations and their representatives were as follows:

- Advanced Systems Office, MSFC

Gordon R. Woodcock

William G. Huber

Terry H. Sharpe

Harold D. Trexler

Luther J. Spears

Robert J. Davies

Edward E. Waggoner

Lynn L. Bradford

● Propulsion & Vehicle Engineering Laboratory, MSFC

William W. Wales	Richard A. Love
Walter A. Johanson	Michael J. Vaccaro
Charles R. Darwin	Wilburn O. J. Randolph

● Aero-Astroynamics Laboratory, MSFC

Ronald D. Scott

● Research Projects Laboratory, MSFC

Dr. Nicholas C. Costes	James A. Downey III
------------------------	---------------------

● Astrionics Laboratory, MSFC

Edward E. Dungan

● Advanced Manned Missions Program Office, Office of Manned Space Flight, NASA Headquarters

Philip E. Culbertson	Jerald M. Goldberg
Lt. Col. Peter Grosz, USA	Donald A. Beattie

● John F. Kennedy Space Center, NASA

Joseph T. Garo	Owen L. Sparks
A. Robert Raffaelli	Warren L. Foss

● Manned Spacecraft Center, NASA

Thomas R. Kloves	Clark Covington
Norman Belasco	Milton A. Silveria

● Astrogeology Branch, U. S. Geological Survey

Dr. Joseph T. O'Connor

● Extraterrestrial Research Agency, U. S. Army Corps of Engineers

Donald W. Butler	James E. Malcolm
------------------	------------------

Dr. Harold Masursky of the Astrogeology Branch, U.S. Geological Survey, was consulted regarding geological experimentation, and Dr. William G. Tift, Steward Observatory, University of Arizona, was consulted regarding optical astronomy. In addition, Dr. Alfred H. Webber of St. Louis University provided general advice on scientific experimentation.

The study also drew on certain previous and concurrent studies for information. The most significant of these were as follows:

- Scientific Mission Support for Extended Lunar Exploration. North American Aviation, Inc., Contract NAS 8-20258 (William McKaig, Study Leader)
- Lunar Surface Mobility Systems Comparison and Evolution Study (MOBEV). Bendix Corporation, Aerospace Systems Division, Contract NAS 8-20334 (Carmelo J. Moscolino, Study Leader)
- Early Lunar Shelter Design and Comparison Study. AiResearch Manufacturing Company, Contract NAS 8-20261 (William L. Burriss, Study Leader)

The study was aided by an independent effort on the part of Mr. Wes C. Schmill of Atomics International, a Division of North American Aviation, Inc., who contributed to the definition of nuclear power systems.

CONTENTS

Chapter		Page
	FOREWORD	iii
	ACKNOWLEDGEMENTS	iv
	INDEX TO VOLUMES I AND II	ix
	ILLUSTRATIONS	xii
	TABLES	xiv
	INTRODUCTION	xv
1	PLANNING APPROACH	1-1
	1.1 Guidelines for Plan Formulation	1-1
	1.2 Approach to Plan Formulation	1-2
2	INTEGRATED SCIENTIFIC PROGRAM	2-1
	2.1 General Approach	2-1
	2.2 Program Description	2-4
	2.3 Program Options	2-10
3	EQUIPMENT SELECTION	3-1
	3.1 Transportation Systems	3-1
	3.1.1 First Saturn V Uprating	3-2
	3.1.2 Second Saturn V Uprating	3-5
	3.1.3 Non-Saturn V Transportation Systems	3-9
	3.1.4 Utilization of Transportation Systems	3-14
	3.2 Mission Equipment	3-14
	3.2.1 Lunar Probes	3-14
	3.2.2 Lunar Orbiters	3-16
	3.2.3 Lunar Shelters	3-17
	3.2.4 Lunar Roving Vehicles	3-18
	3.2.5 Lunar Flying Vehicles	3-21

Chapter		Page
	3.2.6 Base Power Supply	3-25
	3.3 Major Scientific Equipment	3-31
	3.4 Recommended Equipment List and Utilization	3-34
4	PLANNING CONSIDERATIONS	4-1
	4.1 Decision Point 1	4-1
	4.2 Decision Point 2	4-2
	4.2.1 Alternate Programs	4-5
	4.2.2 Funding Requirements	4-5
	4.2.3 Funding Commitments	4-9
	4.2.4 Effect of Delay	4-12
	4.2.5 Effect of Pickup Launch for Crew Return	4-15
	4.3 Decision Point 3	4-17
	4.3.1 Alternate Programs	4-17
	4.3.2 Funding Requirements	4-19
	4.3.3 Funding Commitments	4-19
	4.4 Potential Lunar Programs	4-25
	4.4.1 Exploration Program Descriptions	4-25
	4.4.2 Program Accomplishments	4-27
	4.4.3 Exploration Program Comparison	4-30
	4.5 Implications of Recommended Exploration Plan	4-32
	4.6 Significant Results	4-34
	4.6.1 Scientific Program	4-35
	4.6.2 Exploration Equipment	4-36
	4.6.3 Operations	4-36
	4.6.4 Program and Resources	4-37
Appendix		
A	INTEGRATED SCIENTIFIC PROGRAM AND MISSION DESCRIPTIONS FOR EXPLORATIONS PROGRAMS I, II, III	A-1
B	EXPLORATION PROGRAM SUMMARIES - EXPLORATION PROGRAMS I, II, III	B-1

INDEX TO MIMOSA TECHNICAL REPORT
VOLUMES I AND II

Chapter

- VOLUME I – LUNAR EXPLORATION EQUIPMENT AND MODE DEFINITION
- 1 TRANSPORTATION SYSTEM TECHNOLOGY ANALYSIS
 - 1.1 Task Objectives and Scope
 - 1.2 Task Study Approach and Results
 - 1.3 Guidelines and Assumptions
 - 1.4 Flight Mechanics and Performance Analysis
 - 1.5 Flight System Design and Configuration Determination
 - 1.6 Design Related Analyses
 - 1.7 References
 - 2 MISSION EQUIPMENT TECHNOLOGY ANALYSIS
 - 2.1 Task Objective and Scope
 - 2.2 Task Study Approach
 - 2.3 Guidelines and Assumptions
 - 2.4 Design of Lunar-Surface-Probe Vehicle
 - 2.5 Design of Lunar Orbiter
 - 2.6 Design of Lunar Shelter
 - 2.7 Design of Lunar Roving Vehicles
 - 2.8 Lunar Flying Vehicles
 - 2.9 Lunar Support Systems
 - 2.10 References
 - 3 SCIENTIFIC EQUIPMENT
 - 3.1 Major Scientific Equipment
 - 3.2 Minor Scientific Equipment
 - 3.3 Bibliography
 - 4 EXPLORATION CONCEPT AND MODE ANALYSIS
 - 4.1 Task Objectives and Scope
 - 4.2 Exploration Concept Formulation
 - 4.3 Exploration Concept Mode Formulation

Chapter

- 5 RESOURCE PLANNING
 - 5.1 Introduction
 - 5.2 Equipment Development Planning
 - 5.3 Equipment Cost Analysis
 - 5.4 Analysis of Exploration Concept Mode Costs

VOLUME II – CANDIDATE LUNAR EXPLORATION PROGRAMS

- 1 LUNAR SCIENTIFIC PROGRAMS
 - 1.1 Major Scientific Goals
 - 1.2 Major Scientific Disciplines
 - 1.3 The Scientific Investigation Matrix
 - 1.4 Lunar Scientific Experiments
 - 1.5 Experiment Packages
 - 1.6 Major Scientific Equipment
 - 1.7 Lunar Surface Exploration Patterns
 - 1.8 Description of Locales, Regions, and Paths
 - 1.9 Scientific Program Formulation
 - 1.10 Concluding Remarks
- 2 FORMULATION OF CANDIDATE EXPLORATION PROGRAMS
 - 2.1 MIMOSA Planning Questions
 - 2.2 Candidate Equipment Evolutions
 - 2.3 Scientific Program/Equipment Evolution Combinations
 - 2.4 Generation of Lunar Exploration Programs
- 3 SUMMARY DESCRIPTION OF CANDIDATE EXPLORATION PROGRAMS
 - 3.1 Cost and Schedule Summary
 - 3.2 Lunar Exploration Summaries
- 4 ANALYSIS AND EVALUATION OF CANDIDATE EXPLORATION PROGRAMS
 - 4.1 Planning Decision Points
 - 4.2 Factors Influencing Decision Point 2
 - 4.3 Factors Influencing Decision Point 3
 - 4.4 Program Cost Summary by Transportation System
 - 4.5 Influence of Scientific Program
 - 4.6 Conclusion from Program Analysis

Appendix

- A THE SCIENTIFIC INVESTIGATION MATRIX
- B MIMOSA EXPERIMENT LIST
- C CORRELATION OF NAA LUNAR SCIENTIFIC EXPERIMENTS WITH
MIMOSA SCIENTIFIC INVESTIGATION MATRIX
- D DESCRIPTION OF LOCALES, PATHS, AND REGIONS
- E SUMMARY OF LUNAR EXPLORATION PROGRAMS

ILLUSTRATIONS

Figure		Page
1-1	Approach to Plan Formulation	1-3
2-1	Integrated Scientific Program	2-2
2-2	Lunar Surface Exploration Pattern (Program I)	2-5
2-3	Lunar Surface Exploration Pattern (Programs II and III)	2-6
3-1	Selection of Second Saturn V Upgrading and LLV	3-7
3-2	Logistics Braking and Landing Stage (For 111% Saturn V)	3-10
3-3	Logistics and Personnel Braking Stage (For 188% Saturn V)	3-11
3-4	Personnel Landing Stage (For 188% Saturn V)	3-12
3-5	Personnel Earth Return Stage (For 188% Saturn V)	3-13
3-6	Range and Staytime Requirements for Large Lunar Roving Vehicle	3-19
3-7	Lunar Roving Vehicle	3-23
3-8	Lunar Roving Vehicle Trailer	3-24
3-9	8-kwe Brayton Cycle Powerplant System	3-32
4-1	S/AA Program – Decision Point 1	4-3
4-2	Anatomy of Decision Point 1	4-4
4-3	Alternate Programs – Decision Point 2	4-6
4-4	Scientific Achievement – Decision Point 2 Programs	4-7
4-5	Annual Funding Summary – Decision Point 2 Programs	4-8
4-6	Program Scientific Return – Decision Point 2 Programs	4-10
4-7	Cost Breakdown Comparison – Decision Point 2 Program Through Fiscal Year 1980	4-11
4-8	Anatomy of Decision Point 2	4-13
4-9	Effect of Delaying Decision to Increase Capability – Decision Point 2	4-14
4-10	Effect of Pickup Launch for Crew Return – S/AA → Medium Capability	4-16

Figure		Page
4-11	Alternate Programs – Decision Point 3	4-18
4-12	Scientific Achievement – Decision Point 3 Programs	4-20
4-13	Annual Funding Summary – Decision Point 3 Programs	4-21
4-14	Anatomy of Decision Point 3 (Continued Medium Capability)	4-23
4-15	Anatomy of Decision Point 3 (Increase to Large Capability)	4-24
4-16	Example of Lunar Exploration Programs Resulting from Recommended Plan	4-26
4-17	Cumulative Cost vs. Scientific Manhour Comparison, Programs I, II, and III	4-33

TABLES

Table		Page
3-1	Augmented Lunar Module Mass Summary	3-3
3-2	Saturn V Uprating Required for Augmented Lunar Module Missions	3-4
3-3	Candidate LLV Design Characteristics	3-8
3-4	Time Utilization of Saturn V Transportation Systems	3-15
3-5	Time Utilization of Non-Saturn V Transportation Systems	3-15
3-6	Recommended Lunar Probes	3-16
3-7	Recommended Lunar Orbiters	3-17
3-8	Recommended Lunar Shelters	3-18
3-9	Lunar Roving Vehicle Comparisons	3-22
3-10	Recommended Lunar Roving Vehicles	3-25
3-11	Recommended Lunar Flying Vehicle	3-25
3-12	Base Power Requirements	3-26
3-13	Performance and Mass of Candidate Power Systems	3-27
3-14	Nuclear Heat Sources	3-28
3-15	Power Conversion Systems	3-29
3-16	Mass Comparison of Reactor and Radioisotope Power Plant Combinations	3-30
3-17	Recommended Major Scientific Equipment	3-33
3-18	Recommended Equipment List and Utilization	3-36
4-1	Lunar Program Cost Savings Due to Commonality With Planetary Program	4-22
4-2	Distribution of Scientific Equipment and Manhours for Exploration Programs I, II, and III	4-29
4-3	Comparison of Lunar Programs	4-31

INTRODUCTION

The objectives of the MIMOSA study were twofold – to produce a methodology for generating lunar exploration programs and to generate a recommended lunar exploration plan, using the developed methodology.

The MIMOSA study was divided into the following three phases:

- Phase I – compilation and generation of data for the later phases (these data are contained in the Exploration Equipment Data Book.)
- Phase II – development of the planning methodology that includes a computer program for the mechanization of data handling, generation of a broad spectrum of candidate programs, and comparative analysis to answer certain planning questions
- Phase III – formulation of a recommended plan of lunar exploration, generation of three selected lunar exploration programs for implementing the plan, and intensive design effort for the equipment used in these three programs

Generation of the recommended lunar exploration plan is described in the MIMOSA Technical Report. The methodology is presented in three volumes under MIMOSA Planning Methodology.

This volume describes (1) planning approach, (2) the integrated scientific program, (3) the equipment selection, and (4) planning considerations.

Chapter 1 PLANNING APPROACH

The recommended plan for post-Apollo lunar exploration, described in this volume, was realized through a series of analytical steps. First, equipment candidates and representative scientific programs were defined within the MIMOSA methodology (MIMOSA Technical Report – Vols. I and II). Next, a broad spectrum of candidate lunar exploration programs were generated (MIMOSA Technical Report – Vol. II) to answer a specific set of planning questions. The analysis of these candidate programs provided answers to the specific questions, yielded a general philosophy of exploration based on evolutionary increases in equipment capability and identified three critical decision points that must be addressed by planners. The final step consisted of narrowing down the analyses to a more detailed investigation of these decision points with a limited set of selected equipment in mind. The consequences of assuming the available program options resulted in three alternate exploration programs that constitute typical examples of implementing the exploration plan.

1.1 GUIDELINES FOR PLAN FORMULATION

The guidelines given below were approved by NASA for the final phase of the MIMOSA study. They reflect the information gained from the previous planning phase and also the conditions imposed by a realistic planning environment. These guidelines are as follows:

- Maintain program options through an awareness of the possible use of alternate equipment capabilities; in particular ensure adaptability to any major Saturn V uprating that might be available from a future planetary program
- Demonstrate potential to accommodate an increasing demand for scientific capability

- Assume no major R&D commitment before FY 1970
- Plan on a funding level less than \$1.5 billion per year for lunar operations
- Strive for commonality of equipment with other potential space programs
- Ensure maximum use of developed equipment
- Assure modest launch rates – three to four per year through 1970's and six per year through 1980's

The prevailing theme expressed by these guidelines is the recognition of a need for (1) flexibility to future changing demands through the selection of adaptable equipment and (2) cost effectiveness and low risk through maximum use of well established techniques coupled with efficient utilization of developed hardware.

1.2 APPROACH TO PLAN FORMULATION

The approach adopted for the formulation of a plan of lunar exploration is summarized in Fig. 1-1. It represents a synthesis of the conclusions drawn from the candidate program analysis (MIMOSA Technical Report – Vol. II); in particular it incorporates answers to the postulated basic planning questions. This information is assimilated into a general exploration plan under the NASA-provided guidelines. The step increases in capability and their associated decision points that were developed in the broad spectrum analysis are maintained to allow for alternate program options.

The Saturn Apollo Application (S/AA) equipment is representative of a number of possible candidates that can be introduced at decision point 1, and no attempt was made to optimize performance in this area. The augmented LM (ALM) is used for delivery of two men to the surface and the logistics LM (i. e. , a stripped LM ascent stage) is employed for logistics delivery. The Saturn V rating is the minimum required for delivery of the ALM within the MIMOSA operational ground rules. Mission staytimes are limited to 14 days.

At decision point 2, two options are available; exploration either is continued with the S/AA equipment (continued S/AA) or a capability increase to the medium level is possible. At the medium capability level, three-man surface operations with a large

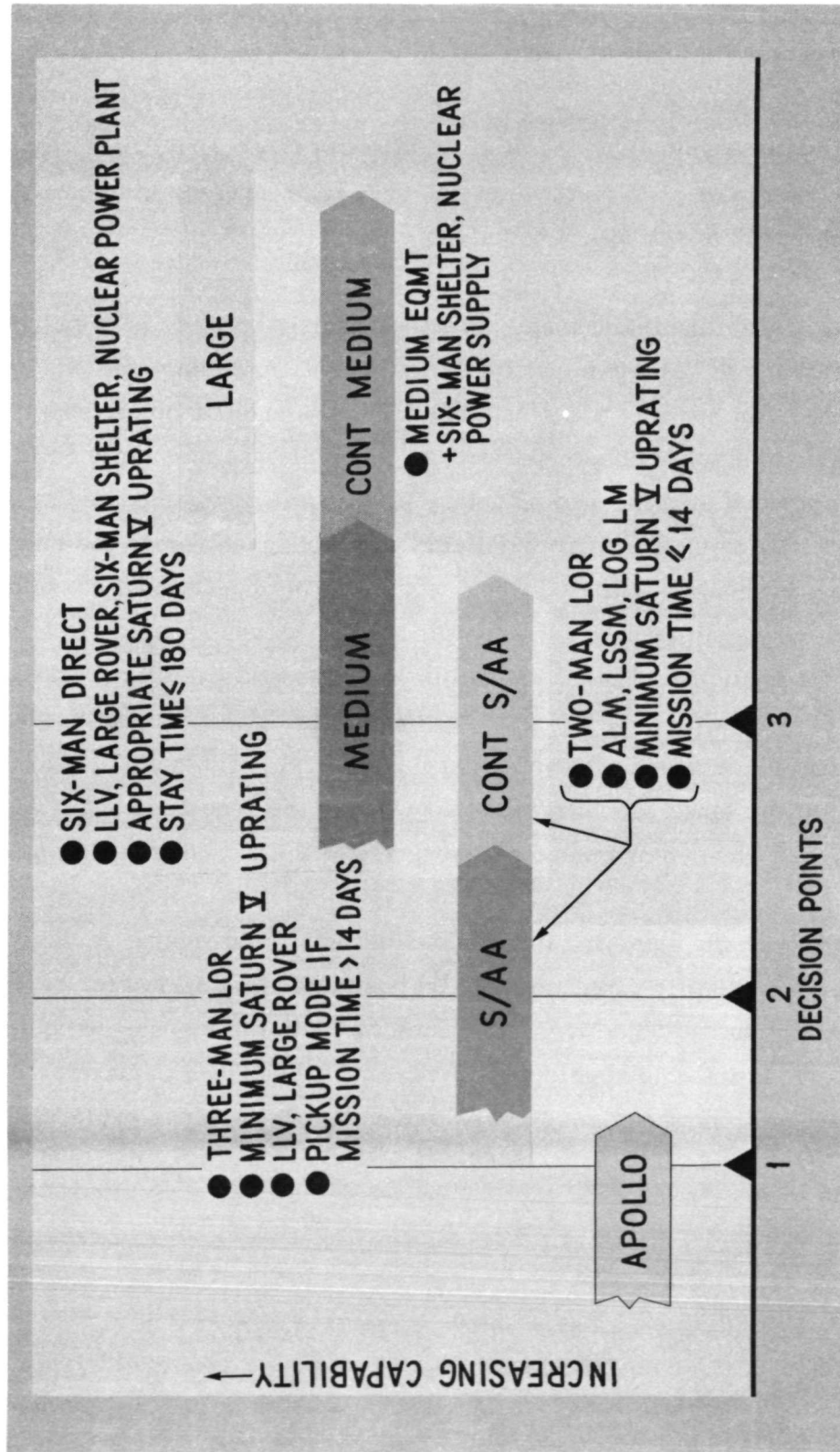

Fig. 1-1 Approach to Plan Formulation

rover for mobility are assumed, and a single stage direct lunar logistics vehicle (LLV) is introduced for logistics. The LOR delivery of crew is maintained and the Saturn V uprating is the minimum required by this flight mode. A conservative approach to crew return is assumed by use of an additional crew pickup launch for mission times in excess of 14 days. This obviates the need for a long staytime deactivated CSM in orbit with possible reliability problems.

If medium capability is assumed, a further decision point is eventually encountered (decision point 3). Medium capability equipment can be maintained, but additional equipment in the form of a six-man shelter and a nuclear power supply is required for the support of extended base operations. Possible use of a large Saturn V launch vehicle provided by a manned planetary program is accommodated by a stepup to large capability. In this case, direct delivery of a six-man crew to the lunar surface is possible and should be utilized when required from operational considerations. To minimize new equipment developments, the LLV stages associated with the Saturn V used at the medium and large capability levels should exhibit commonality. Therefore, a two-stage LLV is suggested at the higher Saturn V uprating that utilizes two of the single stages of the medium capability level. The actual value of the Saturn V uprating at the large capability then depends on the requirement for six-man direct delivery with the compromised performance of the two-stage delivery system.

In keeping with the guideline for responsiveness to increasing evolutionary scientific demands, a scientific program must be postulated that allows for part, and eventually all, of the scientific objectives to be achieved with the increasing equipment capability options. This integrated scientific program is described in Chapter 2. Selection of the actual equipment designs for use in developing the lunar exploration plan is the subject of Chapter 3.

Chapter 2 INTEGRATED SCIENTIFIC PROGRAM

The example scientific programs up to this point of the study were generated with the primary intent to provide a wide range of requirements by which to test and compare the capabilities of many different exploration system concepts. With the reduction of the spectrum of candidate-system concepts to a select few, it is now proposed to capitalize on the experience gained from many test cases and formulate an integrated scientific program to serve as the basis for a recommended lunar exploration plan. In contrast to the example programs, which were conceived without any particular exploration systems in mind, the integrated program is tailored to the capabilities of a prescribed evolutionary pattern of lunar exploration hardware systems.

This chapter discusses the general approach to the formulation of the integrated scientific program, itemizes the contents of the program and summarizes its accomplishments.

2.1 GENERAL APPROACH

The integrated scientific program represents a synthesis and refinement of the example scientific programs generated during the development of MIMOSA methodology. The basic pattern of the integrated program is indicated schematically in Fig. 2-1. It comprises three phases.

The first phase begins in the immediate post-Apollo period with an exploration feasibility and lunar surface reconnaissance phase. The scientific objectives during this phase are confined to the goals identified by the 15 basic questions about the Moon proposed by the Space Science Board of the National Academy of Science at the Summer 1965 Woods Hole Conference. The level of scientific effort is compatible with 28-day

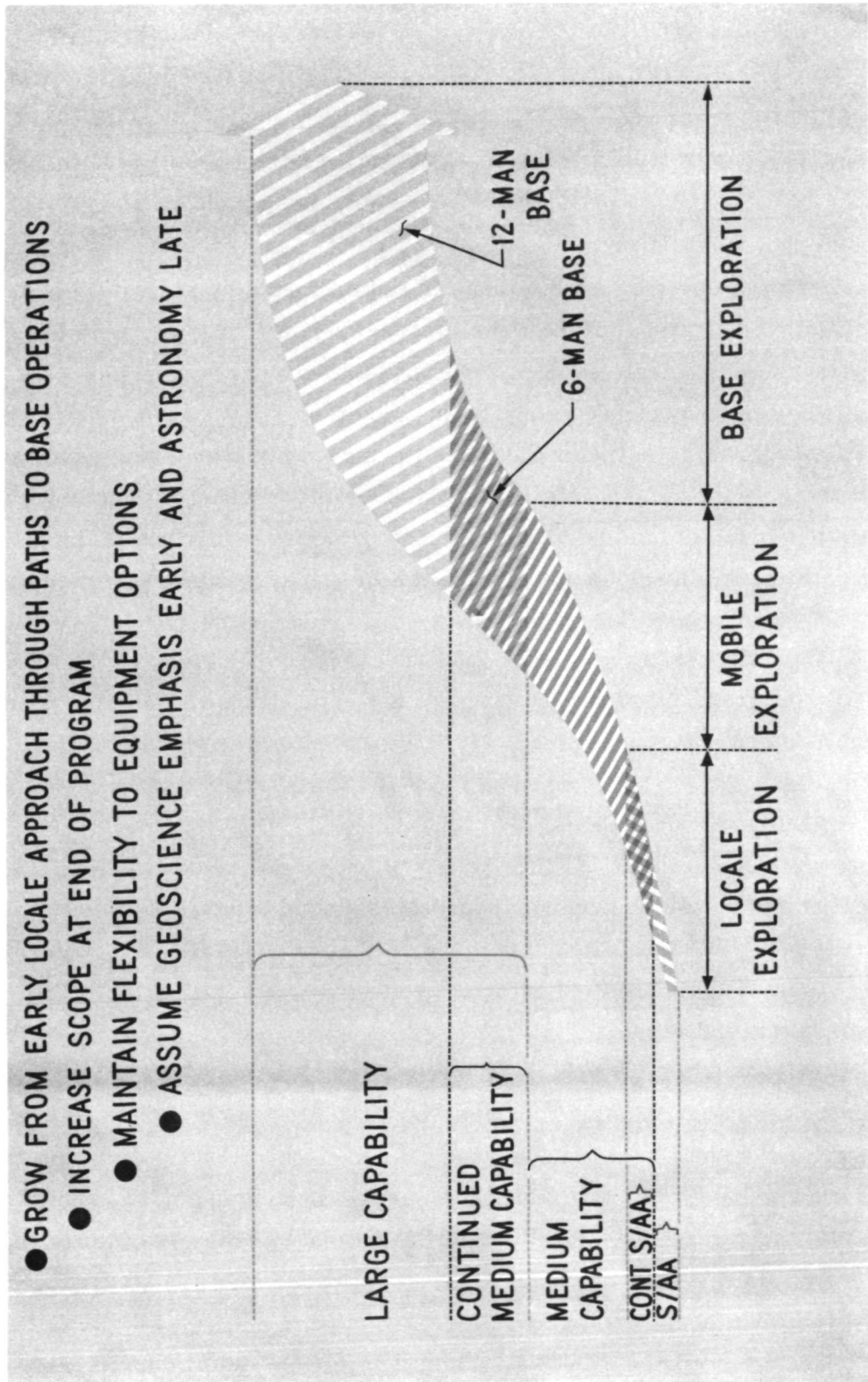

Fig. 2-1 Integrated Scientific Program

manned lunar orbital missions and 14-day locale-type lunar surface missions with surface traverse operations limited to a radius of 10 km about the landing site.

The second phase of the program anticipates equipment capability that permits long-range surface traverses and extended surface staytimes. This is the mobility phase of the program in which emphasis is placed upon surveys along paths of regional geological interest. Scientific goals are still those of the 15 basic questions, but the degree of sophistication of the experiments, the level of scientific effort, and the rate of acquiring scientific data are at least an order of magnitude greater than for the first phase of the program. As an example, the techniques of active seismology are used to probe the lunar subsurface structure to depths of several hundred kilometers in contrast with the potential penetration of several hundred meters anticipated during the first phase of the program.

The third phase postulates a second stepup in system capability permitting the establishment of large lunar bases. The base exploration phase introduces a significant broadening of scientific objectives to encompass extralunar goals beyond the scope of the 15 basic questions. The emphasis is now upon exploitation of the advantages of the Moon as a base for astronomical observatories, for long-term biomedical, geochemical, and materials science research in an extraterrestrial environment, and as an engineering technology development facility.

There is, of course, the option to continue indefinitely with the S/AA level equipment and the more austere objectives associated with that capability rather than advancing to the medium level capability with its more aggressive desires. In a like manner, between the second and third phases of the program the option exists for extending the second phase to the conclusion of the program with the medium level of system capability. Both options have been considered as subsidiary parts of the integrated science program.

The integrated scientific program and the subsidiary optional branches are described in the next two sections.

2.2 PROGRAM DESCRIPTION

A complete description of the integrated scientific program and its associated options, together with the postulated missions, is presented in Appendix A. The surface exploration patterns are shown in Figs. 2-2 and 2-3.

Throughout the program, emphasis is placed on manned exploration. However, unmanned systems, e.g., emplaced scientific stations, automated telescopes, geophone arrays, and orbit-to-surface probes are used where applicable. In particular unmanned orbiters are utilized for communications and site reconnaissance before and after the detonation of seismic charges.

The main objectives of the first phase of the integrated program are to survey the entire surface of the Moon from manned lunar orbiters and to acquire ground truth data essential to the interpretation of the orbital surveys.

The scientific experiments included in the orbital survey missions are capable, for the most part, of automatic operation. The principal role of men on these missions is to monitor and repair equipment. However, some experiments can best be done under direct control of men on the orbiter. For example, experiments in ultra-high resolution photography require a high degree of judgement in selecting target view angles and skill in compensating for the high rate of angular motion of the target.

For reasons of safety, the first manned 28-day lunar orbital mission will probably be in a nearly equatorial plane so as to permit emergency return to Earth throughout the mission. The equatorial orbit mission will be of particular value in calibrating photometric experiments on the sunlit side of the Moon and thermal radiation experiments on the lunar dark side because the same sites will be observed repeatedly under a wide range of view angles and solar illumination angles and at various times during the lunar night. These observations combined with ground truth data derived from Apollo and early S/AA missions to equatorial sites will provide the basis for interpreting the results from polar orbital missions covering the entire lunar surface.

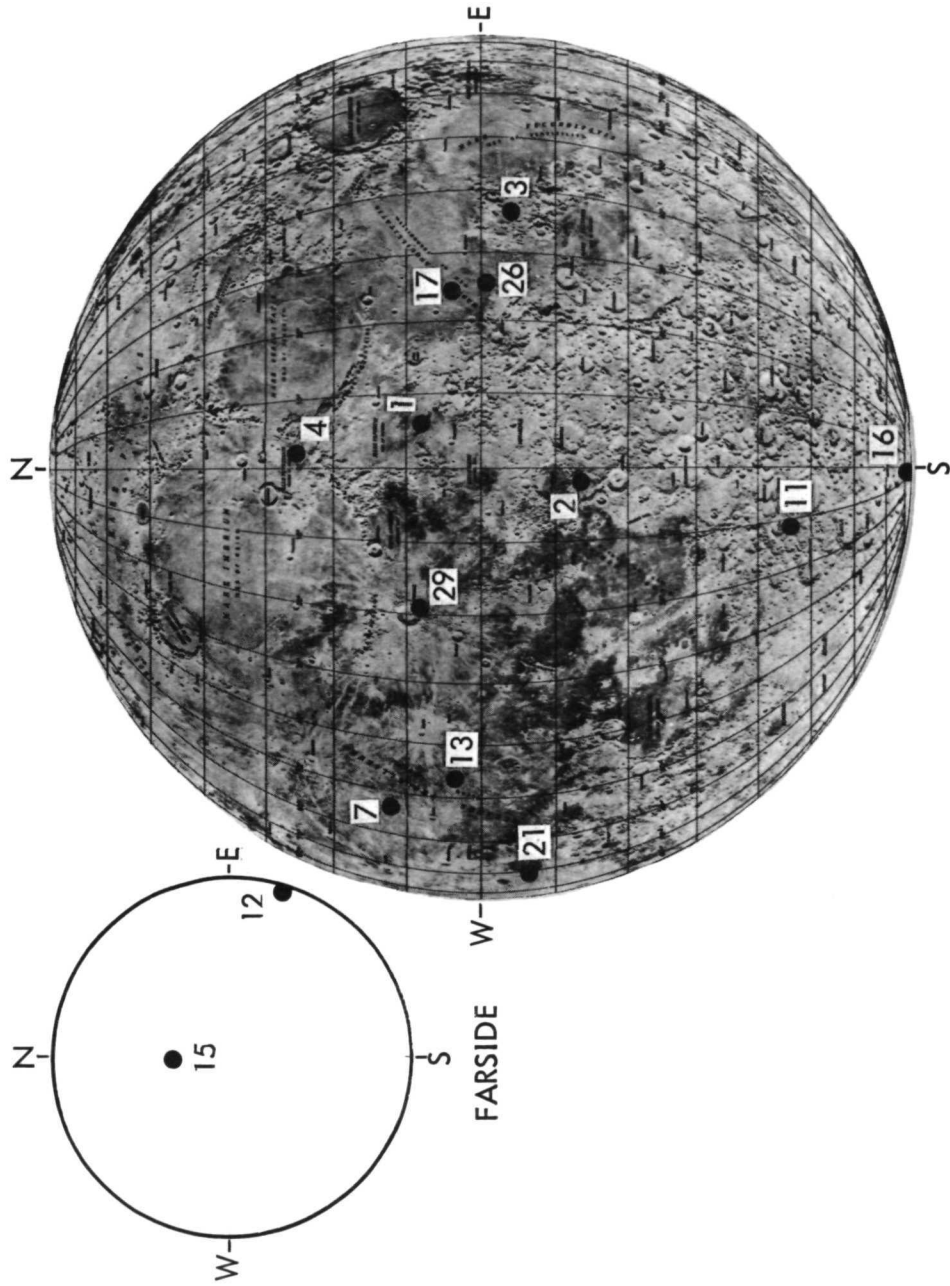

Legend:

Locales

- 1 Hyginus Rille
- 2 Alphonsus
- 3 Capella M
- 4 Hadley's Rille
- 7 Marius Hills
- 11 Tycho
- 12 Mare Orientale
- 13 Oceanus Procellarum
- 15 Center Farside
- 16 South Pole
- 17 Ranger VIII Landing Site
- 21 Grimaldi
- 26 Moltke B
- 29 Copernicus

Fig. 2-2 Lunar Surface Exploration Pattern (Program I)

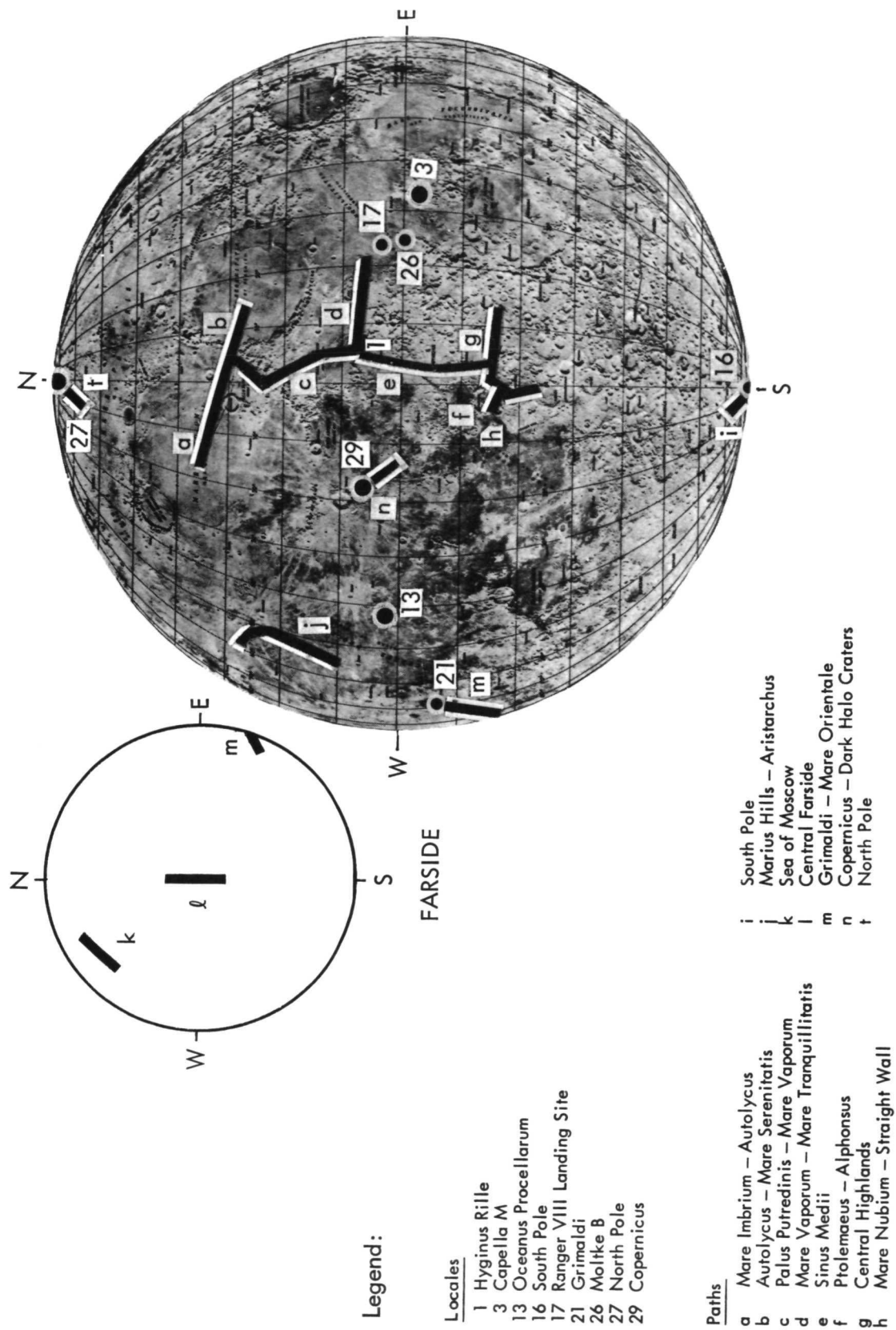

Fig 2-3 Lunar Surface Exploration Pattern (Programs II and III)

It is recommended that the second and third manned 28-day lunar orbiters be placed in polar orbits and timed relative to the lunar month so that one mission will observe the surface just before sunrise and sunset while the other will view the surface just after sunrise and sunset. In this way the entire range of exposure of the lunar surface to the cyclic variation of environmental conditions will be observed and, at the same time, photographic surveys of the entire surface will be obtained with favorable solar illumination angles from both the east and the west, except for the polar regions, which are never favorably illuminated.

The first four locales for S/AA surface missions are selected to provide ground truth data representative of the major portion of the lunar surface. The first locale includes the Ranger VIII impact point near the southwest edge of Mare Tranquillitatis, an example of a "blue" mare area, so called because of a bluish cast in its reflectance spectrum. The Ranger VIII impact crater is of special interest as a means of calibrating the energies of natural cratering processes on the Moon, inasmuch as the Ranger VIII impact was an event of known mass, momentum, and energy.

The second locale is near Capella M, an example of highland terrain with evidence of tectonism that may have exposed some of the subsurface structure.

The third locale is in an undisturbed and presumably uncomplicated area of Oceanus Procellarum. Measurements of gravity, magnetism, seismic activity, and subsurface thermal flux are expected here to be free from perturbations by local structural anomalies and therefore typical of a large part of the Moon.

The fourth locale is near Moltke B in the contact area between Mare Tranquillitatis and the central highlands. The slumping of highland material along the edge of the contact zone is of particular interest at this locale as an example of erosion and material transport processes operating on the Moon.

At this point of the integrated program there is a step up to the medium level of system capability. The principal objective of this second phase of exploration is to

acquire regional geologic data with more emphasis on determining lunar interior structure through long-range surveys. However, two more locale-type missions are performed before undertaking an extended surface traverse. One mission is to Hyginus Rille, a feature strongly indicative of volcanic activity and possibly still seismically active. The other locale mission is to Grimaldi, a smooth dark mare-like crater near the western limb of the Moon slightly south of the equator. The increased level of system capability approximately triples the available manhours for scientific activity. Hence, these last two locales are investigated much more thoroughly than were the preceding locales involving S/AA mission hardware.

The mission to Grimaldi represents the first admission of intent to commit the program to extralunar scientific objectives beyond the scope of goals identified by the 15 basic questions. Grimaldi is to be the site of an astronomical observatory with a variety of radio, optical, and X-ray telescopes and a permanently staffed 12-man base. The intent of the first mission to Grimaldi is primarily to verify the environmental suitability of the site for the proposed astronomical equipment.

The path approach to lunar surface exploration (Fig. 2-3) begins with a mission to Copernicus from which a 400-km traverse is made to a group of dark halo craters southeast of Copernicus. Copernicus is a very large, recent impact crater in Oceanus Procellarum and is presumed to expose the lunar crustal structure to a depth of several kilometers. The dark halo craters southeast of Copernicus are probably volcanic and are expected to yield data on the subsurface composition of the Moon at depths perhaps as great as 40 km, according to terrestrial analogs.

Subsequent missions in this phase of the program undertake increasingly ambitious traverses one of which amounts to 1,600 km with a staytime of 2-1/2 mo.

With the advent of long surface traverses, the emphasis in lunar geoscientific exploration shifts from limited area surface geology to regional geology and geophysical probing of the subsurface structure by means of gravity surveys and active seismology. It is estimated that chemical explosive charges with masses up to 6,000 kg will be

required to generate seismic signals sufficiently intense to be useful at ranges up to 600 km. The integrated program uses hard landing probes from logistics launch vehicles to deliver the largest explosive charges directly to the desired detonation points after appropriate arrays of geophones have been deployed by surface missions. The precise detonation points of the large explosive charges delivered by probes is determined by using lunar photographic orbiters to locate the craters formed by the detonations.

Although direct delivery by hard landing probes is the most economical way to place large explosive charges, the corridor of low-energy trajectories for lunar logistics compatible with the Saturn IB launch vehicle permits use of this mode only for points within the western hemisphere of the Moon as viewed from Earth and a limited range of eastern longitudes on the lunar nearside. Explosives delivered to the poles and all points from 20° E to 200° E are soft landed and manually deployed by surface missions. In these cases only a few hundred kilograms of explosives are used.

The emphasis upon nearside locale and path missions is primarily a reflection of present familiarity with nearside topography, which makes selection of significant targets easier than for the farside. It is anticipated that improved knowledge of the farside through current lunar orbiter photos will lead to a better distribution of mission locations. However, farside missions lack the convenience of a direct line-of-sight communication link to Earth, so lunar orbiting communication satellites are provided as a part of the support of farside missions.

The objective of the third phase of exploration is to provide semipermanent base capabilities for more intensive investigations of lunar and extralunar goals. This third phase of the program begins in the early 1980's with a step increase in capability permitting a dual-launch mission to accomplish an 1,800-km traverse, core drill a 300-m hole, and maintain a temporary base for 3-1/2 mo. The traverse in this case is from the center of Mare Imbrium to the center of Mare Serenitatis and it is expected to yield basic information about the history and mechanism of mare basin filling, whether by a single catastrophic event or by a series of successive mare material flows. The temporary establishment of a base heralds the beginning of the base exploration phase of this program.

A second visit to Grimaldi in the mid-1980's begins the establishment of a permanent astronomical base that is carried through to completion in the late 1980's by a third mission to Grimaldi in which a complex array of radio, optical, and X-ray telescopes is set up in conjunction with a 12-man permanent base. The path approach to lunar surface exploration is carried through the base exploration phase by missions to the poles and to the farside.

2.3 PROGRAM OPTIONS

The total integrated scientific program, that is compatible with the increasing equipment capabilities that evolve from S/AA through medium to large capability, is referred to here as Scientific Program III.

As was mentioned in paragraph 2.1, the option to continue indefinitely with the S/AA level of capability must be considered. The compatible branch of the integrated scientific program is called Scientific Program I. In this program, locale-type missions are carried on for a total of 14 surface missions, the last two missions in the mid-1980's being to the center farside and to the South Pole. The lunar surface exploration pattern is shown in Fig. 2-2.

This option provides no practical means to accommodate major scientific equipment, such as 2-m optical telescopes and 300-m drills. The staytime and payload limitations do not permit use of more than a 100-m drill. However, with visits to a wide variety of major lunar features and with the orbital surveys, the low level option does effectively attack the 15 basic questions about the Moon, but not to the degree of assurance that would be provided by geophysical surveys along extended paths on the lunar surface.

Another program option occurs after the step up to the medium level of system capability by assuming no further increases in exploration system capability. This branch of the integrated scientific program is Scientific Program II (i. e., continued medium

level of capability). The scientific objectives and the lunar surface exploration pattern are the same as for the total three-step integrated program, but the scientific effort is cut almost in half. The difference consists primarily in the establishment of a 6-man semi-permanent base at Grimaldi under the continued medium level program while the large program concluded with a 12-man semi-permanent base.

Programs I, II, and III of the integrated scientific program are presented in Appendix A.

Chapter 3
EQUIPMENT SELECTION

The analysis of the candidate lunar exploration programs (MIMOSA Technical Report — Vol. II) provided answers to a number of questions regarding the choice and performance requirements of exploration equipment to be utilized in the post-Apollo exploration of the Moon. These conclusions were used (Chapter 1) to formulate a general planning approach within the specified guidelines. In the approach, summarized in Fig. 1-1, certain broad categories of exploration equipment were associated with the various equipment options available at three key decision points, together with the operational constraints to be applied in their utilization. The subject of this chapter is to define the specific design requirements for each item of equipment to be used in the exploration plan.

The underlying principle for the selection of the equipment was to ensure (1) evolutionary development, (2) adaptability to program changes, and (3) a minimal number of new equipment items.

The Saturn Apollo Applications (S/AA) equipment items were suggested by NASA as representative of the type of hardware that will be employed in the initial phase of lunar exploration; no attempt was made during the MIMOSA study to make an assessment of the various candidate concepts for the S/AA Phase of Lunar exploration.

The equipment design specifications were based on the following requirements:

- One major failure shall not abort the mission; two major failures shall not prevent a safe return.
- In an emergency, a manned system shall be capable of supporting a crew for 14 days.
- Apollo state-of-the-art technology shall be used wherever possible; advances, if required, must be realistic.

3.1 TRANSPORTATION SYSTEMS

Transportation systems are required for the delivery of personnel and logistics and are composed of the basic launch vehicle and its associated flight systems. The discussion of transportation systems is given below in terms of the related launch vehicle.

3.1.1 First Saturn V Uprating

The results of the analysis of the candidate lunar exploration programs showed that logistics requirements could be satisfied by a relatively modest uprating of the Saturn V vehicle and that the critical initial uprating would be governed by the personnel delivery requirements.

During the S/AA phase of exploration the Augmented Lunar Module (ALM) is used for delivering two men to the lunar surface. The ALM configuration chosen combines the functions of delivery and ascent with that of a shelter with up to 13 days staytime. A mass summary is given in Table 3-1.

Maximum use is made of Apollo hardware. Additional life support, environmental control, and electrical power equipment required for the longer staytime is attached to the descent stage. Primary power is provided by solar cells and batteries, which restricts the concept to daytime missions.

At the medium level capability, the same ALM concept is used to deliver three men to the lunar surface, but only a short time (~ 1 day) shelter capability is provided since the crew live in the roving vehicle and a pick-up launch is used for crew return.

Table 3-2 summarizes Saturn V performance requirements for the delivery of the ALM under various operational conditions. The values quoted are based on the MIMOSA flight/performance ground rules described in MIMOSA Technical Report - Vol. I. These ground rules stipulate a capability for ± 1 day leeway for launch from

the lunar surface. For two-man delivery, complete lunar surface coverage would result in a requirement for 120 percent uprating. However, the restriction of missions to the lunar equator results in a reduction of this requirement to 109 percent. This condition is acceptable for the early S/AA missions; however, complete surface coverage is desirable later. If the conventional (single launch) personnel delivery mode is replaced by the "pickup" concept (delivery and retrieval of personnel by separate launches) all missions can be performed with the 109 percent uprating of Saturn V.

Table 3-1

AUGMENTED LUNAR MODULE MASS SUMMARY

Stage	Mass (kg)
Descent Stage	
Structure	1,021
Propulsion	628
Guidance & Control	23
Environmental Control	232
Power	343
Telecommunications	11
Expendables	10,393
Miscellaneous	200
Ascent Stage	
Structure	525
Propulsion	234
Guidance & Control	310
Environmental Control	129
Power	339
Expendables	2,530
Miscellaneous	<u>296</u>
Total	17,214

Table 3-2
SATURN V UPDATING REQUIRED FOR AUGMENTED LUNAR MODULE MISSIONS

No. of Men in CM	No. of Men on Surface	Surface Staytime (days)	Personnel Flight Mode	Plane Change Capability (deg)	Site Restrictions	Payload Injected to Lunar Transfer (kg)	Vehicle Upgrading (%)
3	2	13	Single Launch	None	Equatorial Only	49,577	109.3
3	2	13	Single Launch	11	None	54,600	120.4
3	2	13 ^(a)	Pickup	35	None	49,577	109.3
4	3	1 ^(b)	Pickup	11	None	50,080	110.4

(a) First launch ascent stage is used for return.

(b) First launch ascent stage is used only to provide abort capability during descent.

Selected concept.

At the medium capability level, a three-man ALM is employed for crew transportation, and the pickup launch (using a four-man CM) is required because of the long mission durations. Under these conditions the required Saturn V uprating is 110.4 percent.

In view of the small difference between the requirements, and to ensure equipment commonality between exploration phases, a 111 percent Saturn V launch vehicle was selected for both S/AA and medium capability phases of the exploration program.

This 111 percent Saturn V provides a capability for placing 50,350 kg (111,000 lb) on a lunar transfer trajectory and a corresponding capability to inject 132,000 kg (292,000 lb) into a 100-nm earth orbit.

During the S/AA phase, the logistics LM (a stripped LM ascent stage) is used for delivery of logistics via the LOR mode. Manned logistics delivery to lunar orbit is assumed, but descent to the lunar surface is automatic. At the medium level, the direct LLV is employed for logistics delivery. The conceptual design of this vehicle is strongly dependent on requirements associated with a larger Saturn V uprating and is discussed below.

3.1.2 Second Saturn V Uprating

The lunar exploration plan calls for the use of a direct lunar logistics vehicle at the medium and large capability levels, and for direct delivery of six men associated with the higher capability. The similarity of these transportation modes offers a certain degree of commonality in the designs resulting in the reduction of the number of new hardware developments.

There are several ways of approaching this commonality. One approach embodies the "multi-mission module" concept where only the propellant tank capacity is tailored for each application, with the remainder of the stage undergoing minimum changes. Alternately a two-stage concept may be adopted where one stage is maintained constant

while allowing the other stage to have various tank sizes, depending on the application. A third approach, which was chosen for MIMOSA, involves using the same basic stage and tank size in all applications, but off-loading for particular applications.

The assumption of a single tank size results in compromised performance at either the lower or higher level of Saturn V uprating, and the LLV design becomes an important factor in the selection of the higher Saturn V uprating. The critical requirement for the higher uprating is that it must provide a six-man direct delivery capability.

Three solutions to the problem are illustrated in Fig. 3-1. The alternate design concepts for the LLV involve (1) single stage optimized for the 111 percent Saturn V and two of these stages used with the higher uprating, (2) single stage optimized for the higher Saturn V uprating and used off-loaded at 111 percent, and (3) two stages optimized for the higher Saturn V uprating and one stage used at the 111 percent level.

The figure indicates the size of the second uprating required to provide the six-man direct capability under the three conditions and the logistics capabilities at both levels of uprating. The configuration chosen was the one that involves single stage optimization at the 111 percent level of Saturn V uprating. This concept provides the highest logistics capability with the 111 percent Saturn V, which is likely to be used over a considerable time period at the medium level, and still maintains good performance at the second level of uprating. This choice results in a requirement for the second uprating of 188 percent of the basic Saturn V.

The second uprating corresponds to a lunar transfer injection capability of 85,300 kg (188,000 lb) and a corresponding capability to inject 224,000 kg (494,000 lb) into 100-nm earth orbit.

The LLV design characteristics, in its various applications, are summarized in Table 3-3. Good propellant fractions are indicated throughout, despite the fact that only minor modifications are made to the stage for each application, with the exception of the Earth return stage, where the tank size is reduced.

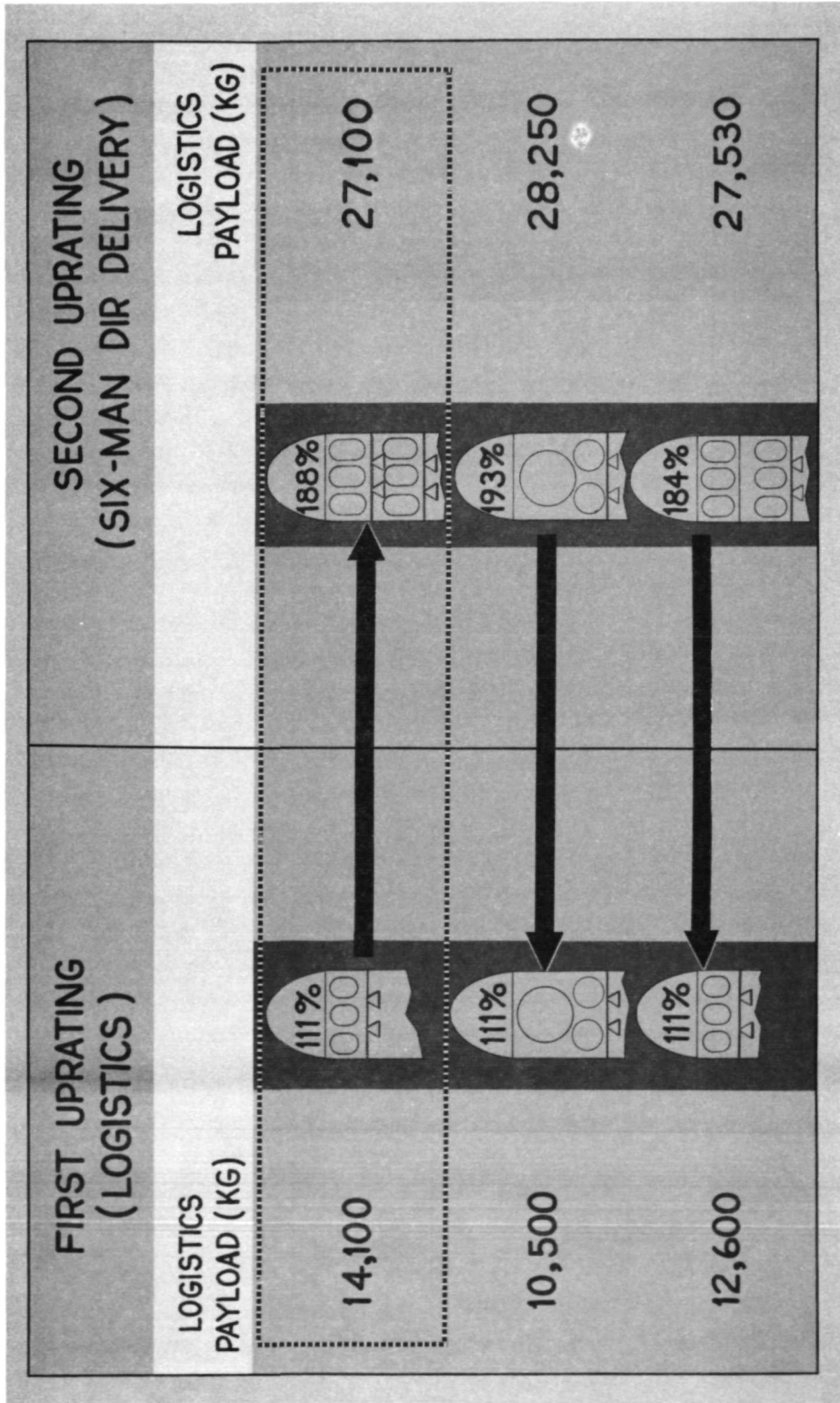

Fig. 3-1 Selection of Second Saturn V Upgrading and LLV

Table 3-3
CANDIDATE LLV DESIGN CHARACTERISTICS

Saturn V Upgrading	111%	188%					
Transportation Function	Logistics Delivery	Personnel Delivery			Logistics Delivery		
Stage	Braking & Landing (b)	Braking (c)	Landing (d)	Earth Return (e)	Braking (c)	Landing (f)	
Propellant (a) Loading (kg)	26,030	18,700	23,200	13,980	18,700	23,100	
Burnout Mass (kg)	10,050	6,300	8,650	5,300	6,300	10,050	
Total Mass (kg)	36,080	25,000	31,850	19,280	25,000	33,150	
Propellant Fraction	0.725	0.75	0.73	0.725	0.75	0.70	

- (a) All stages use cryogenic (LH₂/LOX) propellants.
- (b) This is the basic stage, and it is optimized for this application.
- (c) This stage is derived from the Braking and Landing Stage by removal of subsystems not required, primarily the landing gear (2354 kg).
- (d) This stage is derived from the Braking and Landing Stage by removal of unnecessary subsystems, primarily the reaction control subsystem, which is on the Earth Return Stage, and reductions in electrical power and telecommunications subsystems.
- (e) This stage is derived from the Braking and Landing Stage by removal of landing gear and reduction of tank size (3469 kg) and reductions in electrical power and telecommunications subsystems.
- (f) This stage is identical to the Braking and Landing Stage with "offloaded" propellants.

Configurational arrangements of the selected basic LLV stage in its various applications are shown in Figs. 3-2 through 3-5.

Medium Level Application. The basic design is employed as a braking and landing stage for logistics delivery with the 111 percent Saturn V. As shown in Fig. 3-2, it comprises two liquid hydrogen tanks, two liquid oxygen tanks, two RL10A-4-2 engines developing a thrust of 66,750N, and a telescoping landing gear assembly.

Large Level Application. At this capability level various combinations of the basic stage are used with the 188 percent Saturn V for logistics and personnel delivery. The logistics version comprises a landing stage which is essentially the system shown in Fig. 3-2 and the braking stage of Fig. 3-3 which is the same as the landing stage, without unnecessary subsystems, such as the landing gear. The personnel version comprises the following; (1) a braking stage which is the braking stage of Fig. 3-3, (2) a landing stage, shown in Fig. 3-4, which is similar to the logistics version with the removal of those subsystems that are now carried in the earth return stage, and (3) an earth return stage, shown in Fig. 3-5, which has smaller tanks than the other versions of the stage.

3.1.3 Non-Saturn V Transportation Systems

Certain requirements of the integrated scientific program can be fulfilled by using transportation systems with smaller capabilities than the Saturn V based system. These requirements stem from the unmanned delivery of relatively small payloads such as photographic orbiters, communication relay systems and explosives. Two existing launch vehicles were considered for these functions viz. Atlas/Centaur and Saturn SIB/Centaur. These systems satisfy the payload requirements and should be regarded as representative since their availability in the time period of interest is by no means certain. In addition, the Saturn SIB was postulated for development flight testing of some of the new transportation flight systems.

KEY

- 1 LIQUID HYDROGEN TANKS
- 2 LIQUID OXYGEN TANKS
- 3 RL10A-4-2 ENGINES
- 4 LANDING GEAR

DIMENSIONS IN METERS

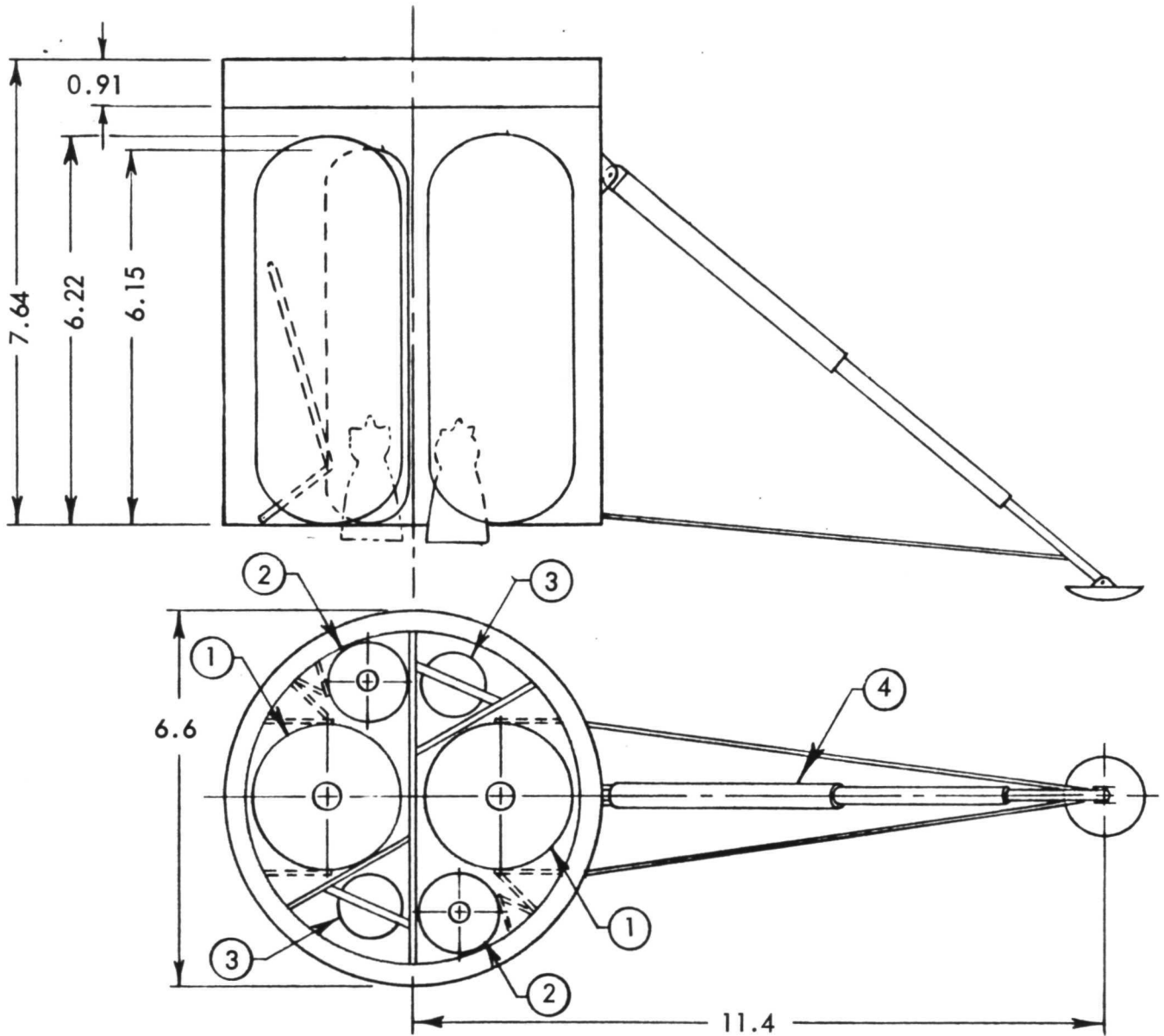
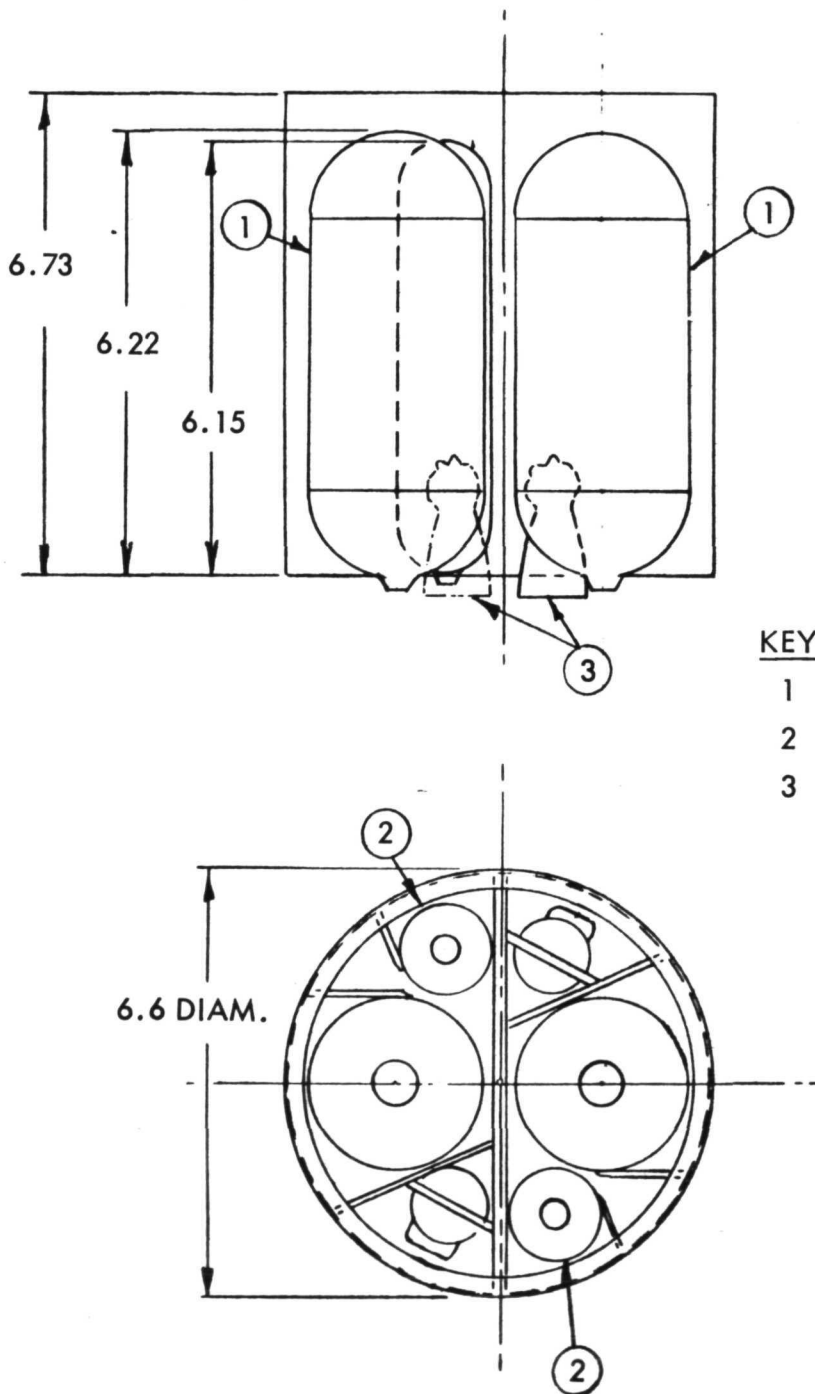

Fig. 3-2 Logistics Braking and Landing Stage (For 111% Saturn V)

DIMENSIONS IN METERS



KEY

- 1 LIQUID HYDROGEN TANKS
- 2 LIQUID OXYGEN TANKS
- 3 RL10A-4-2 ENGINES

Fig. 3-3 Logistics and Personnel Braking Stage (For 188% Saturn V)

KEY

- 1 LIQUID HYDROGEN TANKS
- 2 LIQUID OXYGEN TANKS
- 3 RL10A-4-2 ENGINES
- 4 LANDING GEAR

DIMENSIONS IN METERS

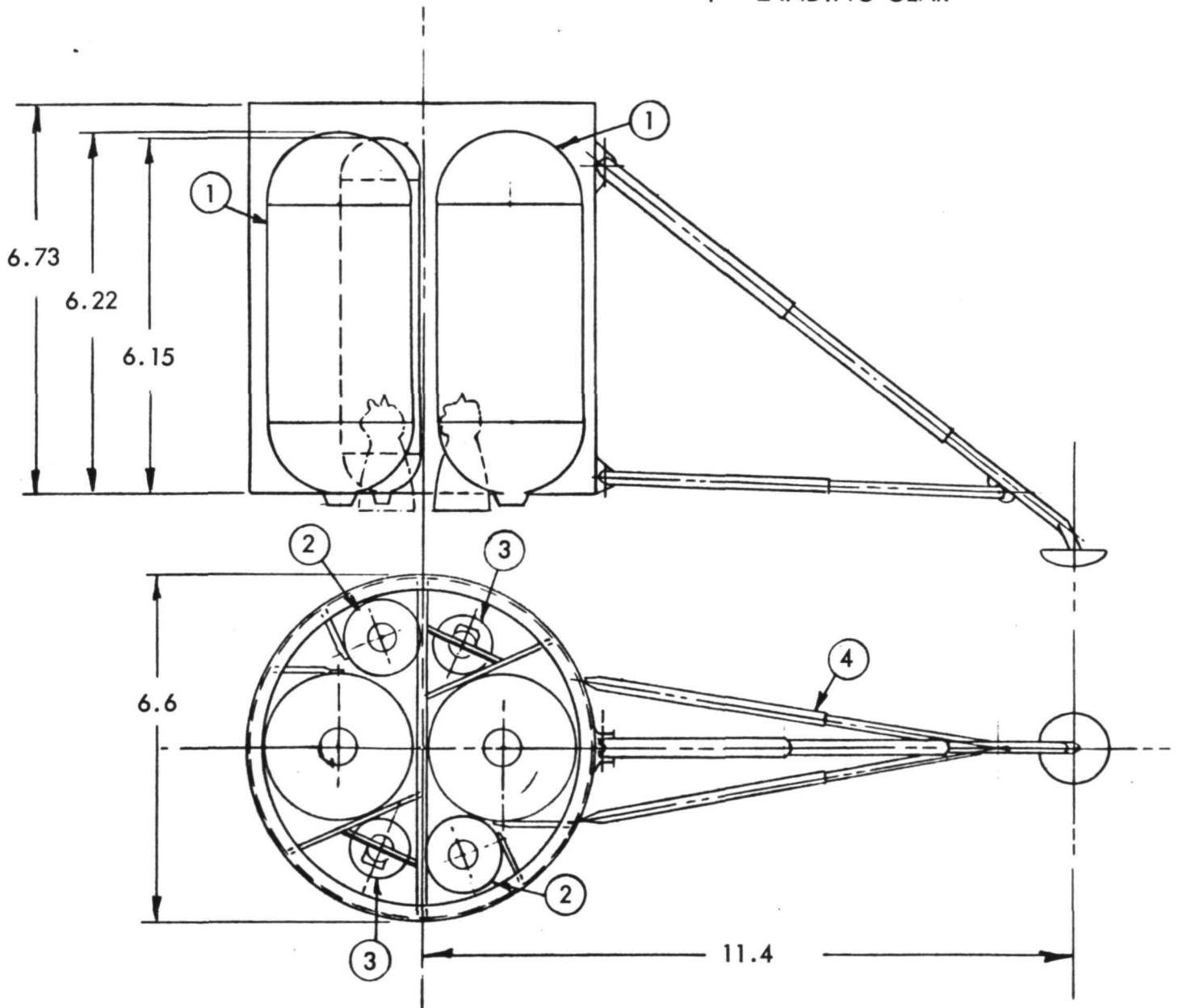

Fig. 3-4 Personnel Landing Stage (For 188% Saturn V)

KEY

- 1 LIQUID HYDROGEN TANKS
- 2 LIQUID OXYGEN TANKS
- 3 RL10A-4-2 ENGINES

DIMENSIONS IN METERS

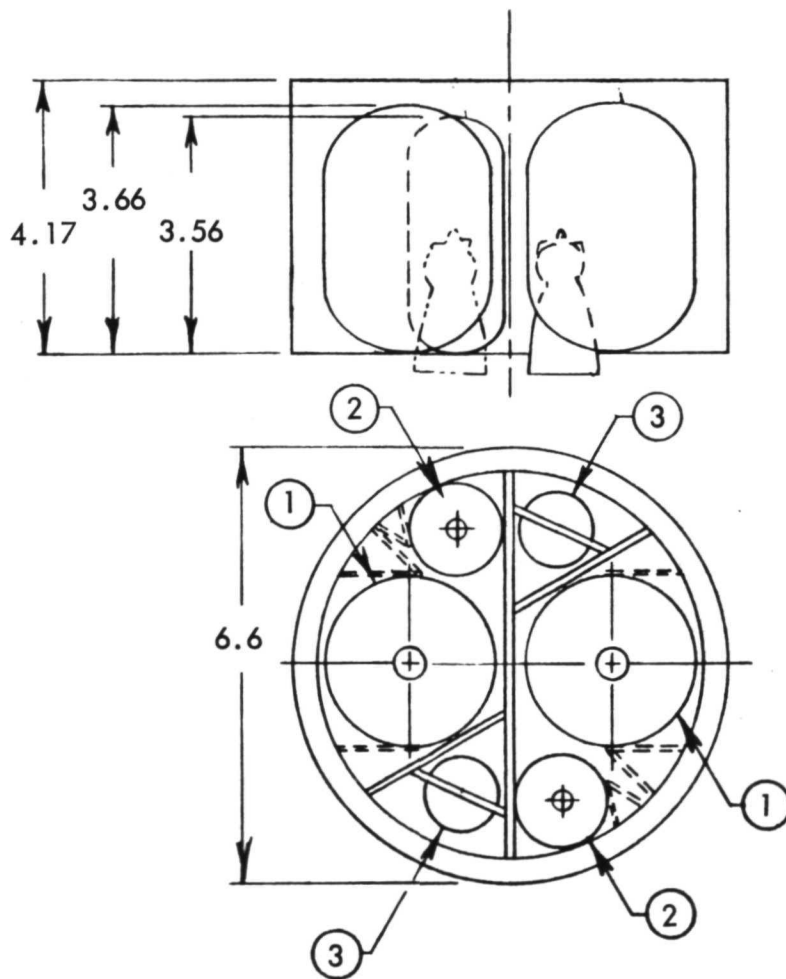

Fig. 3-5 Personnel Earth Return Stage (For 188% Saturn V)

3.1.4 Utilization of Transportation Systems

The evolutionary manner in which the Saturn V-based transportation systems will be utilized in executing the lunar exploration plan is summarized in Table 3-4. The introduction dates are based on the exploration program requirements developed in Chapter 4. Conceptual designs and performance estimates were derived for the launch vehicles and flight systems shown in the table and are reported fully in the MIMOSA Data Book (MIMOSA Planning Methodology— Vol. II)*. Similar information for the non-Saturn V systems is presented in Table 3-5.

Inspection of these tables indicates that a relatively small number of transportation system components are required for executing the exploration plan. Table 3-4 shows that a major launch vehicle requirement is for the 111 percent Saturn V. The requirement for the second uprating will be strongly influenced by future plans for manned planetary flight, but it should be at least 188 percent to provide the six-man direct delivery capability for lunar missions. The major logistics spacecraft beyond S/AA is the LLV. Design commonality among the LLV stages for the various applications results in a small number of new developments. The list of minor transportation systems (Table 3-5) is small. In view of this, and the fact that the availability of the Atlas- and SIB-systems is in doubt, alternate methods of satisfying the small payload requirements should be considered.

3.2 MISSION EQUIPMENT

The mission equipment as defined for MIMOSA comprises lunar orbiters and probes, lunar shelters, roving and flying vehicles and power plants required in support of lunar missions. This section describes the method of selection, and lists the resulting equipment inventory for each mission equipment category.

3.2.1 Lunar Probes

During the analyses of various missions of the exploration plan, no requirement could be found for the use of earth launched or lunar surface launched probes. However, two

* Data Book ID numbers for each equipment can be obtained from Table 3-18.

Table 3-4

TIME UTILIZATION OF SATURN V TRANSPORTATION SYSTEMS

Capability Level	Date of Introduction	Launch Vehicle	Flight Systems	Operation
S/AA	1971	111% Saturn V	3-Man CM SM 2-Man ALM	Personnel delivery of 2 men to surface via LOR
S/AA	1971	111% Saturn V	3-Man CM SM Augmented Logistics LM	Logistics delivery via LOR
S/AA	1971	111% Saturn V	SM	Manned orbiter
Continued S/AA	1975	111% Saturn V	3-Man CM SM	Personnel pick-up of 2 men
Medium & Continued Medium	1975	111% Saturn V	4-Man CM SM	Personnel delivery of 3 men to surface. Pick-up of 3 men
Medium & Continued Medium	1975	111% Saturn V	Braking & Landing Stage (LLV)	Direct logistics delivery
Large	1981	188% Saturn V	Braking Stage Landing Stage Earth Return Stage, 6-Man CM	Direct personnel delivery of 6 men
Large	1981	188% Saturn V	Braking Stage Landing Stage	Direct logistics delivery

Table 3-5

TIME UTILIZATION OF NON-SATURN V TRANSPORTATION SYSTEMS

Capability Level	Date of Introduction	Launch Vehicle	Operation
S/AA & Continued S/AA	1971	Atlas/Centaur	Delivery of photographic and communications orbiters
Medium & Large	1975	Saturn IB	Development test
Cont. S/AA Medium & Large	1975	Saturn IB/ Centaur	Direct delivery of explosives

types of lunar orbit launched probes were found desirable: (1) a probe, hard landing about 130 kg of payload on the lunar surface (for delivery of rugged instruments, e. g. , seismometer at locations not visited on surface missions), and (2) a probe, capable of soft landing 175 kg of payload (for delivery of sensitive instruments, e. g. , mass spectrometers). In both cases, the designs identified early in the study were found to be adequate to perform the required missions. A summary of the recommended probe candidates is given in Table 3-6.

Table 3-6

RECOMMENDED LUNAR PROBES

Launch Mode	Data Sheet Number	Performance	Total Mass* (kg)
Lunar Orbit Launched	2121-01	Hard landing 129 kg payload	533
Lunar Orbit Launched	2122-01 (Modified Surveyor)	Soft landing 175 kg payload	1415

*Including payload.

3.2.2 Lunar Orbiters

Requirements for two classes of orbiters were identified. An unmanned orbiter for photography of the lunar surface and a manned orbiter to conduct a wide variety of lunar experiments using the CSM configuration as a basic vehicle.

The requirement for the various photographic missions and for communications support of manned lunar missions led to the selection of a 1000-kg unmanned orbiter, which requires an Atlas/Centaur as the launch vehicle.

For manned lunar orbiter missions a concept was found to be satisfactory which uses the CSM to accommodate three men for orbital missions up to 30 days and

which is used in combination with the NASA Rack to accommodate a variety of experimental packages. Unmanned probes (paragraph 3.2.1) can be included in the orbiter payload. This equipment was considered to be representative and no attempt was made to investigate the possible variations of concepts.

A summary of the lunar orbiter concepts selected for the recommended lunar exploration plan is given in Table 3-7.

Table 3-7

RECOMMENDED LUNAR ORBITERS

Launch Mode	Data Sheet Number	Performance	Total Mass (kg)
Unmanned Orbiter	2211-03	193 kg payload	1060
Manned Lunar Orbiter with NASA Rack	2222-03	3-Men, 30-day stay-time, 14,000 kg payload	2107
	2222-02		998

3.2.3 Lunar Shelter

During the S/AA-phase of the lunar exploration plan the requirement to shelter two men for up to 14 days could be met by the Augmented LM which is used also for crew delivery (see paragraph 3.1.1). For base activities at the medium and large capability level extended staytime shelters to house 6- to 12-man crews for periods of six months and with operating life times of three years were required.

The selection of a shelter design was influenced by the desire of using one basic design at both capability levels and by the desire for utilizing the basic shelter arrangement possibly as a living module for interplanetary and earth orbital missions. These requirements led to the selection of a shelter which can house six men, using a cylindrical center section of 6.1-m diameter and an open floor plan, adaptable to

manifold interior arrangements. At the large capability level, two of these shelters are used to support a 12-man level base. A summary of the recommended shelter concepts is given in Table 3-8.

Table 3-8

RECOMMENDED LUNAR SHELTERS

Launch Mode	Data Sheet Number	Performance	Total Mass (kg)
ALM	2321-05	2 men, 13 day stay-time	5600 (shelter/ascent stage + shelter expendables on descent stage)
Lunar Shelter	2325-08	6 men for 3 years with 6 month re-supply of expendables	11,496

3.2.4 Lunar Roving Vehicles

Geological and geophysical exploration requirements call for intensive traversing of the lunar surface. The integrated scientific program provides a requirement for extensive use of lunar roving vehicles with a wide variation of required ranges and staytimes. Requirements for 2 classes of roving vehicles were identified. One class is a one-man vehicle for use early in the exploration plan in association with smaller logistic vehicle capabilities. This requirement could be filled by the various concepts of the local scientific survey module (LSSM) as part of the S/AA inventory. The second class of vehicles required comes into use with the advent of medium and high logistics vehicle capabilities and calls for a three-man lunar roving vehicle of extended staytime, range and payload capabilities. The staytime and range requirements such vehicles will face are shown in Fig. 3-6, which summarizes requirements generated during the mission planning for the candidate lunar exploration programs early in the MIMOSA study. Each point in the figure represents range

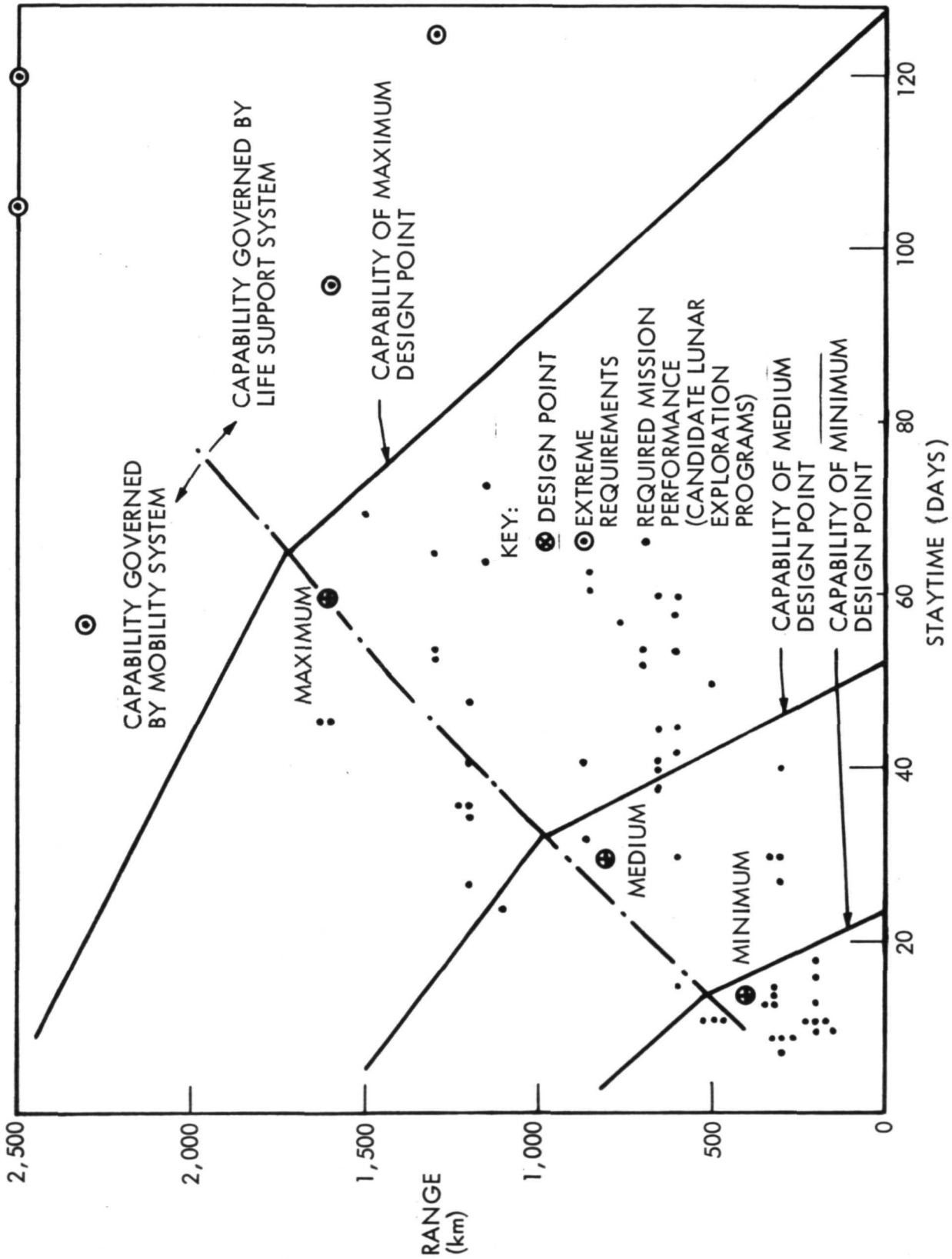

Fig. 3-6 Range and Staytime Requirements for Large Lunar Roving Vehicle

and staytime requirement for one mission. An analysis was made to define one or several lunar roving vehicles which can most efficiently and economically perform the required mission. For this analysis, five missions which showed "Extreme Requirements" (see Fig. 3-6) were not considered in order to reduce the overall spread of requirements.

Two approaches to implement the total spectrum of requirements were considered; (1) a single vehicle design, consisting of a prime mover and a trailer, which would satisfy all requirements, and (2) a selection of three vehicles (no trailers), each individually optimized to cover part of the total requirement spectrum.

For the single vehicle design, three design points were considered.

- A vehicle designed with the maximum design point capability (Fig. 3-6). Use of such a vehicle imposes unacceptably severe performance penalties on the plurality of missions with essentially smaller range/staytime lunar requirements.
- A vehicle designed with the capability of the minimum design point (Fig. 3-6) and augmented by a trailer for the more demanding missions. The design study of the resulting vehicles showed pronounced differences in the sizing requirements of wheel and drive mechanism, power system, and chassis of the prime mover and the trailer which did not satisfy the desire for commonality of subsystems.
- A vehicle designed with the capability of the medium design point (Fig. 3-6). The design point was so selected, that the resulting prime mover and trailer had essentially common subsystems. The prime mover can satisfy the less demanding missions by off-loading, it can perform the design point missions by trading expendables between mobility system and life support systems (as indicated by the break in the capability line of the three design points in Fig. 3-6), and it can perform the more demanding missions by using the trailer. This concept was selected as the best compromise for the single vehicle design.

This single vehicle design was compared in its operational efficiency and cost with the three optimized vehicles sized for the requirement of the minimum, medium and maximum capability design points (Fig. 3-6). For the purpose of this analysis a representative operational theater was selected which called for performing six missions of 400 km, six missions of 800 km, and three missions of 1600 km traverse length. The results of the analyses are presented in Table 3-9a and b. It can be seen, that the single vehicle concept calls for 14,163 kg more mass to be transported to the moon and has a \$634 million lower cost for development, procurement and operations of the roving vehicles. The cost of transporting the additional mass to the lunar surface is estimated to be \$312 million assuming a cost of \$22,000 per kg using 111% rated Saturn V and an LLV. Accounting for this transportation cost still leaves a cost difference of $634 - 312 = 322$ million dollars in favor of a single vehicle concept. This cost advantage and the simplicity of having only one three-man vehicle with a trailer covering the entire spectrum of missions led to the recommendation of this concept.

The configuration of the recommended lunar roving vehicle is shown in Fig. 3-7 and the configuration of the trailer in Fig. 3-8.

A list of the candidate lunar roving vehicles recommended for the lunar exploration program is shown in Table 3-10.

3.2.5 Lunar Flying Vehicles

Mission planning during the MIMOSA study did not establish specific requirements for lunar flying vehicles. However, the need for such a vehicle to assist in visiting places that are inaccessible to roving vehicles was recognized. A vehicle has been selected which provides for sorties up to 3.5 km radius carrying one man. (See Table 3-11.)

Table 3-9

LUNAR ROVING VEHICLE COMPARISONS

(a) Comparison by Mass

Type of Mission	No. of Missions	Total Mass of Lunar Roving Vehicles (kg)	
		Three Optimized Vehicles	Single Vehicle
400 km - 14 days	6	24,612	31,146
800 km - 30 days	6	40,554	41,124
1600 km - 60 days	3	<u>30,750</u>	<u>37,809</u>
Total		95,916	110,079
Mass Difference		14,163 kg	

(b) Comparison by Cost

Type of Mission	No. of Missions	Total Cost* of Lunar Roving Vehicles (\$M)	
		Three Optimized Vehicles	Single Vehicle
400 km - 14 days	6	393	414
800 km - 30 days	6	406	74
1600 km - 60 days	3	<u>376</u>	<u>53</u>
Total		1,175	541
Cost Difference		\$634 million	

*Development procurement and operational cost.

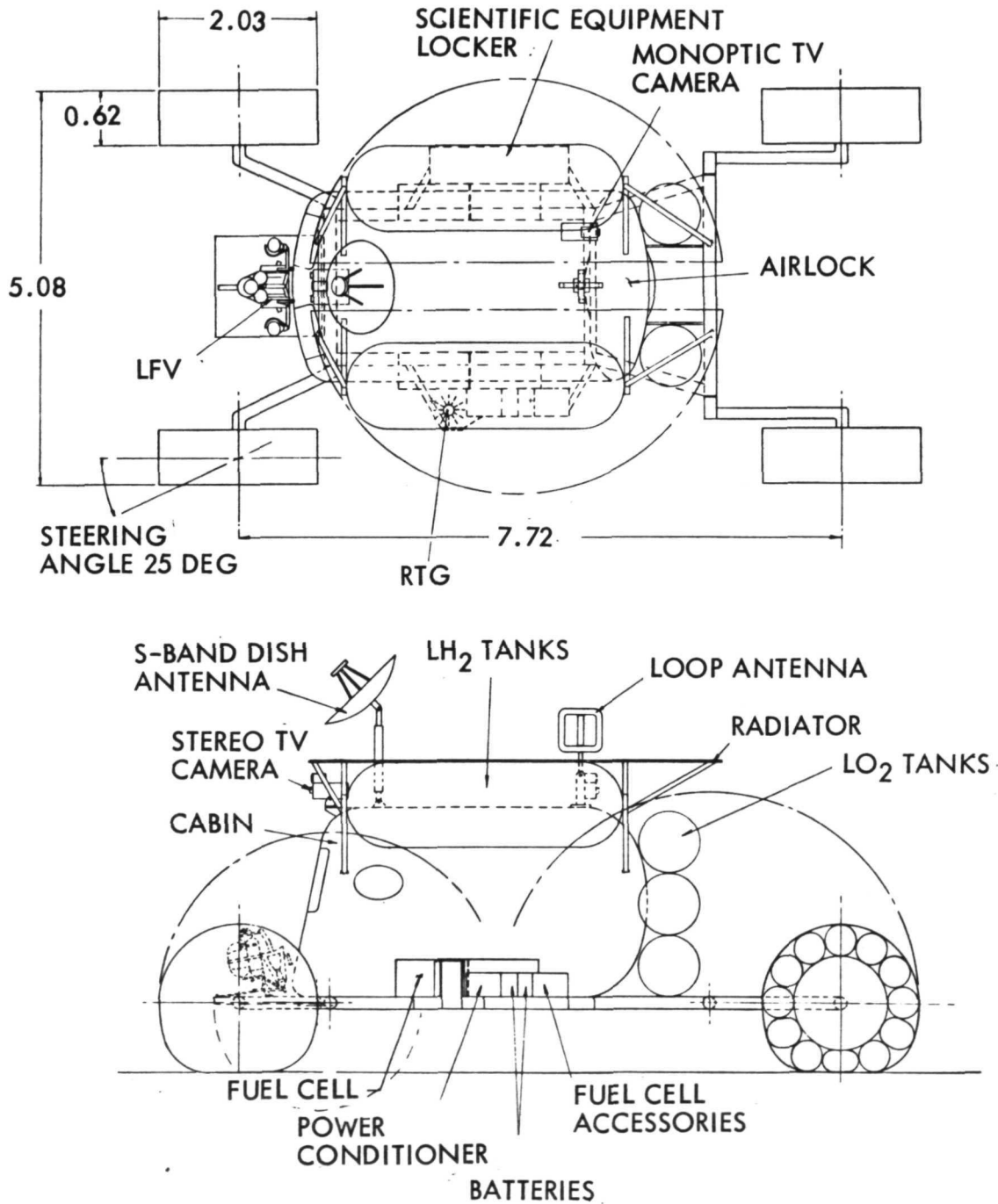

Fig. 3-7 Lunar Roving Vehicle

DIMENSIONS IN METERS

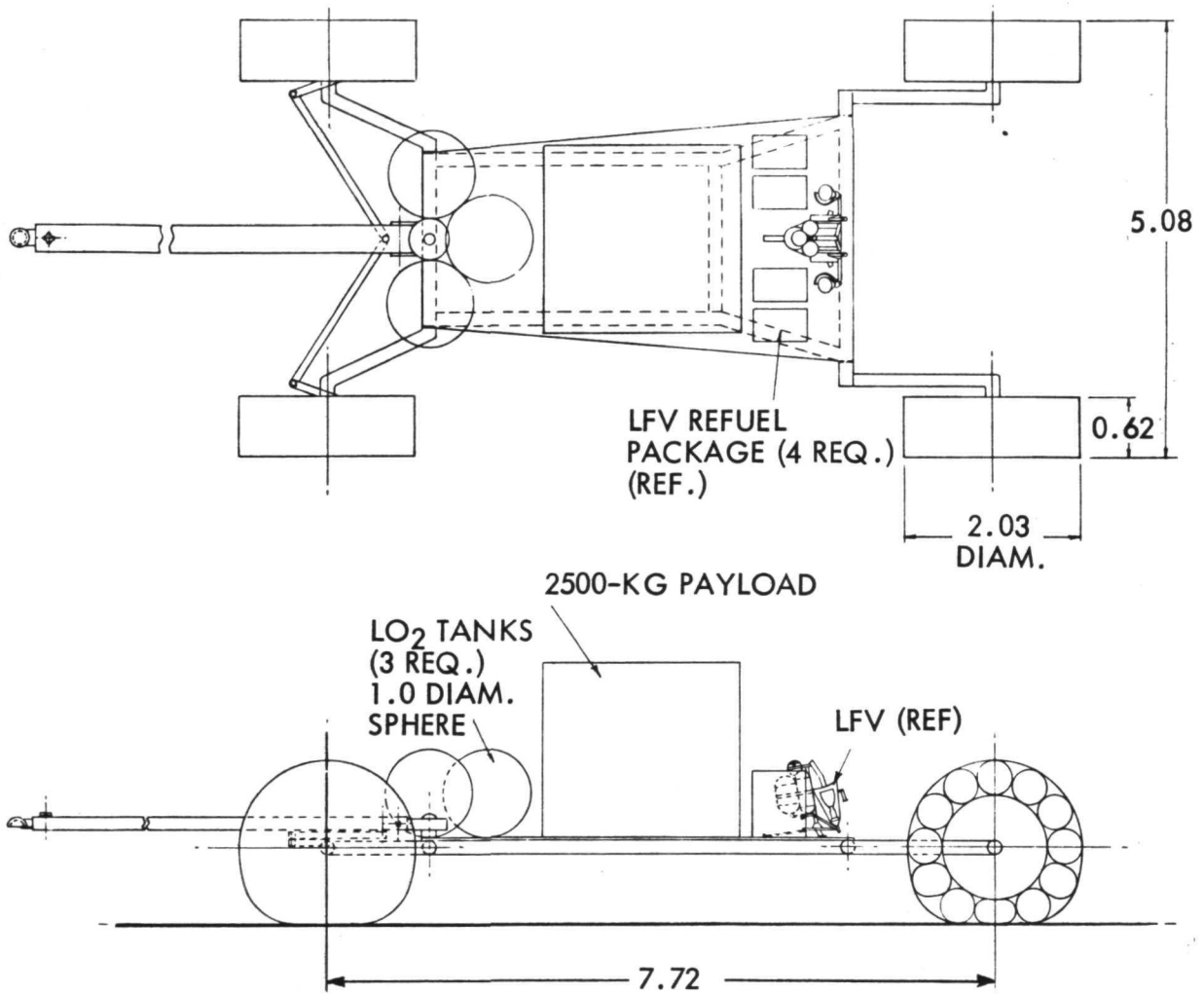

Fig. 3-8 Lunar Roving Vehicle Trailer

Table 3-10

RECOMMENDED LUNAR ROVING VEHICLES

Vehicle Type	Data Sheet Number	Performance			Total Mass (kg)
		Range (km)	Staytime (days)	Payload (kg)	
Manned Vehicle, no cabin - 1 man	2421-01 (LSSM)	30/sortie	6 hr/sortie	320	722
Manned Roving Vehicle, cabin 3 man					
- Basic Vehicle Off loaded	2423-03	400	14	700	5682
- Basic Vehicle	2423-04	800	30	1500	7368
- Basic Vehicle + Trailer (for traversing)	2423-05 + 2434-02	1600	60	2500	12614
- Basic Vehicle + Trailer (for base support)	2423-05 + 2434-01	50	-	6500	15150

Table 3-11

RECOMMENDED LUNAR FLYING VEHICLE

Vehicle Type	Date Sheet Number	Performance	Total Mass (kg)
Exploration, one man	2511-02	3.5 km Radius, Excursion time 3 hours, 40 kg Payload	136.5

3.2.6 Base Power Supply

The exploration plan recognizes a requirement for a power supply in support of 6-man and 12-man semi-permanent bases with an expected mission duration of up to three years. Base power requirements were derived from the individual subsystem requirements shown in Table 3-12.

Table 3-12

BASE POWER REQUIREMENTS

Item	Power Requirements (kw)	
	6-Man	12-Man
Life Support	6.8	13.6
Telescope (2)	2.0	2.0
Flood Lights	1.0	1.0
Communication	1.0	1.0
Other Experiments	2.2	4.4
Total	13.0	22.0

These requirements represent maximum demands and are therefore somewhat conservative. Since the interrelation of the various duty cycles could not be well established, it was decided to use the relatively modest totals shown in Table 3-12 as a conservative power system design requirement.

The first step towards the design of the power supply was to select a system concept. The following concepts were evaluated:

- Batteries
- Combination of solar cells used during lunar day and batteries used during lunar night
- Fuel cells
- Combination of solar cells and fuel cells
- Combination of solar cells, fuel cells, and fuel regenerators
- Nuclear

The evaluation consisted of determining the mass of each concept when required to supply 22 kw for 3 yr, or a total energy of 578,160 kw-hr. Further requirements were that (1) a single failure should not abort the mission, and (2) a dual failure should not prevent a safe return. Table 3-13 lists the specific performance assumed for each system, and the resultant total mass of the system.

Table 3-13

PERFORMANCE AND MASS OF CANDIDATE POWER SYSTEMS

Power System	Performance	Mass (kg)
Battery (Silver/ Zinc)	<ul style="list-style-type: none"> • 50 w-hr/kg • 50 recharges • 70% depth of discharge 	11,570,000
Solar Cells ⁽¹⁾ / Battery	<ul style="list-style-type: none"> • Solar cells: 50 kg/kwe 	147,070
Fuel Cell	<ul style="list-style-type: none"> • 0.5 kg/kwe-hr (including spares and reactants) 	289,000
Solar Cells ⁽¹⁾ / Fuel Cell	<ul style="list-style-type: none"> • Solar cells: 50 kg/kwe • Fuel cell: 0.5 kg/kwe-hr 	147,170
Solar Cells/ Fuel Cell/ Fuel Regenerator	<ul style="list-style-type: none"> • Solar cells: 50 kg/kwe • Fuel cell: 100 kg/kwe (including spares but no reactants)⁽²⁾ • Fuel regenerator: 400 kg/kwe 25% efficiency⁽³⁾ 	16,500
Nuclear	<ul style="list-style-type: none"> • 200 kg/kwe 	4,400

(1) Daytime use only.

(2) Reactants regenerated in fuel regenerator.

(3) For example, one w-hr of energy will regenerate reactants for 0.25 w-hr of fuel cell energy.

----- Selected concept.

From Table 3-13 it is apparent that the nuclear system offers substantial mass savings for the support of a 3-yr base when compared with the other power system concepts. Therefore, a nuclear system for base power support was elected in principle and an analysis performed to derive a recommendable solution for such a system.

A nuclear power supply incorporates a heat source and a power conversion system. Many alternate design concepts are available for each of these components. The heat sources considered in the study are given in Table 3-14.

Table 3-14

NUCLEAR HEAT SOURCES

Power System	Fuel Type	Fuel	
Radioisotope	Alpha emitter	Polonium 210 <div style="border: 1px dashed black; padding: 2px;">Plutonium 238</div> Curium 242 Curium 244	Prime Candidate
	Beta emitter	Cobalt 60 Strontium 90 Promethium 147 Thulium 170	
Reactor	Thermal	<div style="border: 1px dashed black; padding: 2px;">Uranium Hydride</div>	Alternate Candidate
	Fast	UO ₂ UO ₂ Cermet UC UN	

Plutonium 238 was selected as the prime radioisotope heat source candidate because of its power density for the 3-yr mission requirement, lower radiation level, and experience in other space applications such as SNAP-3, SNAP-9A, and SNAP-27. The only reactor program now under development is based on the hydride fuel. This program is SNAP-8, and previous work on hydride reactors was performed on SNAP-2 and SNAP-10A. The SNAP-10A program did yield a flight test of a hydride-fuel reactor in which the power generation system was silicon-germanium (Si-Ge) thermoelectrics. In view of this experience, the hydride reactor was selected as an alternate candidate appropriate for the lunar base power system comparative analysis.

The types of power conversion systems considered are listed in Table 3-15.

Table 3-15

POWER CONVERSION SYSTEMS

Static	Thermoelectric	Pb-TE Si-Ge Cascaded
	Thermionic	Vacuum Cs-Diode
	Magneto-Hydro-Dynamic	Gas 2-Phase
Dynamic	Rankine	Mercury Alkali metal Organic Water
	Brayton	Argon He-Xe

Many of the concepts are of academic interest only. The thermoelectric type offers excellent reliability and ease of development at the expense of relatively low efficiency and high specific mass. The thermionic type is in an initial stage of development and it is too early to predict the capability for a 3-yr mission. The Magneto-Hydro-Dynamic (MHD) system requires even more development and offers no potential advantage for the lunar application. The Rankine and Brayton cycle systems both warrant consideration in the lunar application. The Rankine cycle matches well with the reactor heat source; the Brayton, with the radioisotope heat source. In the power range of interest, only the combination of hydride reactor and mercury Rankine cycle has received any extensive development effort. Among the radioisotope systems, the Brayton cycle has received most attention. Hence, the power system choice can be logically narrowed down to the radioisotope/Brayton and the hydride-reactor/Rankine-mercury. This process of elimination has been qualitative, but the selections presented are representative of the best performance attainable by nuclear systems during the time period of interest.

The two prime power supply candidates are compared in Table 3-16, which indicates the masses associated with the various combinations that satisfy the power and reliability requirements. Examination of this table shows that the Reactor/Rankine systems are consistently heavier than the comparable radioisotope/Brayton systems. It shows also that for the 6-man base (14 kwe), as well as for the 12-man base (24 kwe), the total systems mass for the reactor/Rankine concept increases if the total power output is produced by an increasing number of plants, whereas the reverse is true for the radioisotope/Brayton system. This is because the reactor system requires considerable shielding, and the shielding of a single large unit is lighter than for multiple units providing the same power level.

Table 3-16

MASS COMPARISON OF REACTOR AND
RADIOISOTOPE POWER PLANT COMBINATIONS

Power Plant	Number of Plants						
	6-Man Lunar Base			12-Man Lunar Base			
	2	3	4	2	3	4	6
<u>Reactor/Rankine</u>							
System Power (kwe)	14	14		24	24	24	
Plant Power (kwe)	14	8		24	14	8	
Number of Initial Plants	1	2		1	2	3	
Number of Standby Plants	1	1		1	1	1	
Mass of Initial Plants (kg)	3,727	6,374		4,627	7,445	9,561	
Mass of Standby Plants (kg)	1,657	1,225		2,377	1,657	1,225	
Total Mass (kg)	5,384	7,599		7,004	9,111	10,786	
<u>Radioisotope/Brayton</u>							
System Power (kwe)	14	14	14	24	24	24	24
Plant Power (kwe)	14	8	4.8	24	14	8	4.8
Number of Initial Plants	1	2	3	1	2	3	5
Number of Standby Plants	1	1	1	1	1	1	1
Mass of Initial Plants (kg)	2,384	2,860	2,763	3,974	4,768	4,290	4,605
Mass of Standby Plants (kg)	1,768	1,078	710	2,918	1,768	1,078	710
Total Mass (kg)	4,152	3,938	3,473	6,892	6,536	5,368	5,315

Selected
Concept

Selected
Concept

The reliability requirements - that one failure shall not abort the mission and that a dual failure shall not prevent a safe return - leads to the specification of a minimum of three independent power plants (two initial plants and one standby plant). A further stipulation was that the power plant concept selected for the 6-man base could also be used for the 12-man base. These requirements could be fulfilled by selecting a radioisotope/Brayton unit concept with a single-plant power of 8 kwe. Three of these plants are recommended for use with the 6-man base and four plants for use with the 12-man base. A configuration drawing of the selected concept is shown in Fig. 3-9.

3.3 MAJOR SCIENTIFIC EQUIPMENT

Some lunar scientific operations involve equipment of such size, mass, or support requirements as to represent major problems in transport, deployment and maintenance. These are identified as major scientific equipment. Examples are the 300-m core drill, a Mills cross long-wave radio telescope, and an astronomical observatory.

From the total spectrum of conceptual major scientific equipment, developed for use in the candidate lunar exploration programs, a selection of recommended items was made to serve the objectives of the integrated scientific program. The list of recommended major scientific equipment is given in Table 3-17, which identifies the equipment by title and data book number and indicates the principal functions and total mass of each item.

The main categories of major scientific equipment are drills, telescopes and laboratories. The 300-m core drill is the only example of a drill that is treated as an item of major scientific equipment. It is regarded as an important component of investigations concerned with the subsurface structure and composition of the moon, the measurement of thermal flux from the lunar interior, the determination of the chronological sequence of lunar events, and the search for volatile materials, organic activity, and evidence of life.

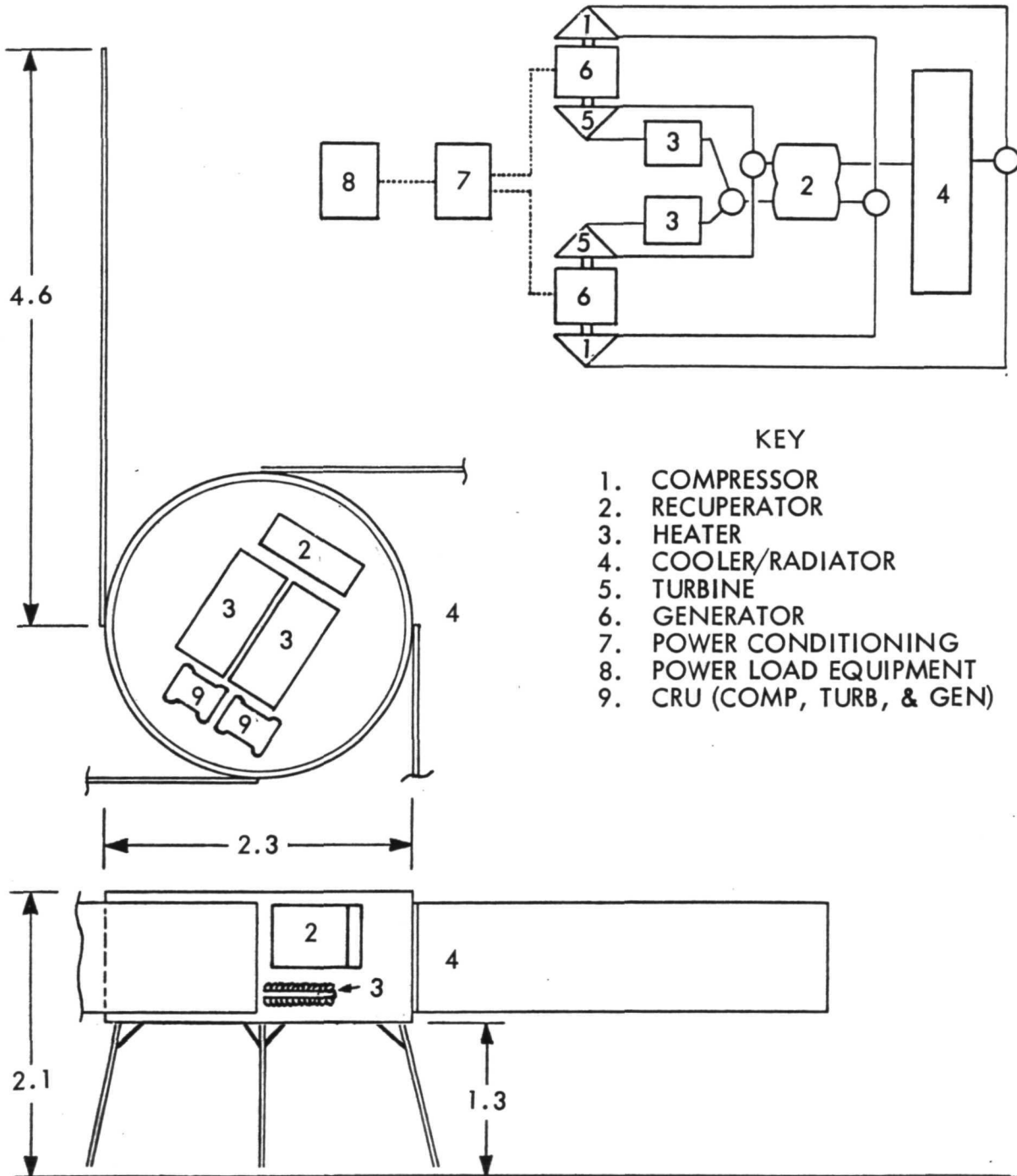

Fig. 3-9 8-kwe Brayton Cycle Powerplant System

Table 3-17

RECOMMENDED MAJOR SCIENTIFIC EQUIPMENT

Data Book Number	Title	Function	Mass (kg)
3213-02	300-m Core Drill	Subsurface samples and structure, thermal flux, lunar chronology	10,428
3242-02	1-m Optical Telescope	Moderate resolution planetology and Earth observations	1,300
3242-03	1.3-m Optical Telescope	Moderate resolution stellar astronomy	5,025
3242-04	2-m Optical Telescope	High resolution stellar astronomy	13,950
3242-05	Solar Observatory	High resolution solar physics	35,410
3243-01	Stellar Observatory	Deep-space galactic and intergalactic astronomy	23,750
3231-01	X-Ray Telescope	High resolution X-ray stellar astronomy	1,620
3224-01	Mills Cross Radio Telescope	Long wavelength, 0.3-1.0 MHz radio astronomy	12,528
3223-01	Radio Telescope Dish	Shortwave, millimeter to submillimeter radio astronomy	22,250
3132-02	Geochemical Laboratory	Preliminary analysis, selection and preparation of lunar samples for delivery to Earth	1,130

Various telescopes have been recommended, including radio, optical and X-ray telescopes. The scientific objectives of these instruments are primarily extralunar. That is, they are concerned primarily with solar phenomena, planets, comets and asteroids, and galactic or intergalactic objects of interest. Their inclusion in lunar scientific programs is based upon the assumption that the moon will provide an advantageous base for telescopic observations.

The solar and stellar observatories may be regarded as laboratories in much the same sense as the geochemical laboratory. That is, they involve the collection and analysis of data and the preparation of materials for delivery to Earth. In the case of the

observatories, the data are concerned almost entirely with extralunar phenomena, while the geochemical laboratory collects data from lunar samples and observations.

All the selected items of major scientific equipment are intended for use during the later phases of the exploration plan, i. e., medium and large capability levels. The exploration equipment used in these phases provide the necessary logistics delivery and crew staytimes for operation of these large equipments. All of the equipment listed in Table 3-17 are regarded as nonportable and, therefore, are associated with base-type operations.

3.4 RECOMMENDED EQUIPMENT LIST AND UTILIZATION

A primary objective of the MIMOSA study was to identify the minimum number of equipment concepts that can in an evolutionary fashion effectively perform the total lunar exploration program, that offer low program cost, through modularity, and that are insensitive to changes in program objectives.

The preceding sections described how the requirements extracted from the candidate lunar programs were used to identify the recommended equipment candidates for each equipment class. This section presents the total recommended equipment and utilization. The Table 3-18 lists, for each phase of the Recommended Exploration Plan, the equipment recommended for transportation and flight systems, for mission equipment, and for major scientific equipment. The total number of different equipment listed is sharply reduced when compared with the large number of items defined and used in the candidate lunar exploration programs. A relatively small number of equipment is required for each phase of the plan. Those items that characterize a phase have been shown enclosed by heavy lines, and those items that first have to be developed for a phase show an asterisk.

Utilization of the recommended equipment during various phases of the recommended plan is as follows:

The Saturn/Apollo Application (S/AA) phases are characterized by a short duration, two-man system, with shelter provided by the Augmented Lunar Module Shelter, and limited mobility provided by the Local Scientific Survey Module (LSSM). The transportation systems are based on a 111 percent uprating of the Saturn V. No major scientific equipment is included. However, a 30-m drill and emplaced scientific station are utilized throughout the program.

The initial phase of the medium level program is characterized by extended mobility provided by a large three-man roving vehicle augmented by a trailer. The transportation system is still based on a 111 percent Saturn V uprating to provide a direct delivery capability for logistics through the use of a Lunar Logistics Vehicle (LLV). The major scientific equipment consists of a 300-m drill.

The extension of the medium level program is characterized by an extended base operation using a 6-man shelter and a nuclear supply. The transportation systems are the same as used in the initial medium level program. The major scientific equipment includes the 300-m drill as well as an array of optical, X-ray, and radio telescopes.

The large program is characterized by a 12-man base operation using two of the 6-man shelters. The transportation system is based on a 188 percent uprating of the Saturn V and provides direct delivery of a 6-man crew. The major scientific equipment is the same as in the continuation of the medium level program.

Table 3-18
RECOMMENDED EQUIPMENT LIST AND UTILIZATION

Phase/Operation	Transportation System/ Flight System	Mission Equipment	Major Scientific Equipment
Apollo Two men, 48-hr Maximum Staytime at equatorial sites	*Personnel 1111-03(a) (Launch Vehicle)1221-03 Basic Saturn V		
Saturn/Apollo Applications Two men, 13-day Staytime Logistics Capability - 5,650 kg -LOR Equatorial Sites	*Personnel 1111-05 *Launch Vehicle 1231-04 (111% Saturn V) *Command Module 1311-03 (3-man) *Service Module 1324-02 *Descent Stage 1331-02 *Logistic 1133-03 Launch Vehicle 1231-04 (111% Saturn) Command Module 1311-03 Service Module 1324-02 Descent Stage 1331-02	*LRV 2421-01 (LSSM) *Manned Orbiter 2222-03 (3 man) NASA Rack 2222-02 *Unmanned Orbiter 2211-03 *Probe, Soft Landing, Lunar Orbit Launch 2122-01 *Probe Hard Landing, Lunar Orbit Launch 2121-01	
Two Men on Surface One Man remains in orbit	*Manned Orbiter 1152-04 Launch Vehicle 1231-04 (111% Saturn) Service Module 1324-02 *Unmanned Orbiter 1161-01 *Launch Vehicle 1212-01 (Atlas/ Centaur)	*Shelter 2321-05 (2-man ALM, 13 day)	

*Indicates New Development
 Indicates Principal Items Characterizing the Phase
 (a) Data Book identification number

Table 3-18 (Continued)

Phase/Operation	Transportation/System Flight System	Mission Equipment	Major Scientific Equipment
Continued Saturn/Apollo Applications Two Men, Up to 30-day Staytime Logistics Capability - 5,650 kg -LOR All Sites Accessible	Personnel 1111-05 (a) Logistics 1133-03 *Personnel 1111-07 (pickup) Launch Vehicle 1231-04 Command Module 1311-03 Service Module 1324-02 Unmanned Orbiter 1161-01 *Explosives Transport 1151-02 *Launch Vehicle 1213-01 (Saturn IB/Centaur)	LRV 2421-01 (LSSM) Unmanned Orbiter 2211-03	
Crew is Retrieved by Pickup Transport	*Personnel 1113-02 Launch Vehicle 1231-04 *Command Module 1313-02 (4-man) Service Module 1324-02 *Ascent Stage 1342-02 Descent Stage 1331-02 *Logistics 1143-01 Launch Vehicle 1231-04 *Braking and Landing Stage 1442-08 Explosives Transport 1151-02	Unmanned Orbiter 2211-03 *LRV 2423-03 (3-man, 14 day, 400 km, 700 kg) *LRV 2423-04 (3-man, 30 day, 800 km, 1,500 kg) *LRV 2423-05 (Use with Trailer) *LRV 2434-01 (Cargo Trailer)	*Drill 3213-02 (300-m)
Medium Level Three Men up to 60-day Staytime Logistics Capability 14,100 kg (Direct) Extended Mobility			
Crew is delivered and Retrieved by Pickup Transport			

*Indicates New Development
 Indicates Principal Items Characterizing the Phase
 (a) Data Book identification number

Table 3-18 (Continued)

Phase/Operation	Transportation/System Flight System	Mission Equipment	Major Scientific Equipment
Medium Level (Cont.)	<p>*Development Test Transport 1171-01 Launch Vehicle 1214-01 (Saturn IB) (Used for development test of 1442-08)</p>	<p>*LRV and Trailer Combination 2434-02 (3-man 60-day 1,600 Km, 2,500 Kg)</p> <p>*LFV 2511-02 (1-man 3.4 km Radius, 40 kg, 1 stop)</p>	
Continued Medium Level Same as Medium Level with the Addition of a 6-man Shelter and a Nuclear Supply Providing Staytimes up to 3 yr with 6 mo Re-supply and Crew Rotation	<p>Personnel 1113-02 (a)</p> <p>Logistics 1143-01</p> <p>Unmanned Orbiter 1161-01</p> <p>Explosives Transport 1151-02</p>	<p>LRV 2423-04</p> <p>LRV 2423-05</p> <p>LRV 2434-01</p> <p>LRV and Trailer 2434-02</p> <div style="border: 1px solid black; padding: 2px; width: fit-content;"> <p>*Shelter 2325-08 6 man - 3 yrs)</p> </div> <div style="border: 1px solid black; padding: 2px; width: fit-content;"> <p>*Nuclear Supply 2722-04 (22 kw Isotope/ Brayton)</p> </div>	<p>Drill 3213-02 (300 m)</p> <div style="border: 1px solid black; padding: 2px;"> <p>*Radio Telescope 3222-01 (Mills Cross)</p> </div> <p>*Radio Telescope 3223-01 (Parabolic)</p> <p>*Radio Telescope 3224-01 (Mills Cross)</p> <p>*X-Ray Telescope 3231-01 (Grazing Incidence)</p> <p>*X-Ray Telescope 3231-02 (Wide Angle)</p> <p>*Optical Telescope 3242-02 (1m)</p> <p>*Optical Telescope 3242-05 (Solar)</p> <p>*Optical Telescope 3243-01 (2.5-m)</p>

*Indicates New Development
 Indicates Principal Items Characterizing the Phase
 (a) Data Book identification number

Table 3-18 (Continued)

Phase/Operation	Transportation/System Flight System	Mission Equipment	Major Scientific Equipment
<p>Large</p> <p>Same as Continued Medium Level with the Addition of Another 6-man Shelter, Providing a 12-man Capability.</p> <p>Personnel Delivery is 6 Man Direct.</p> <p>Logistics Capability is 27, 100 kg Direct.</p>	<p>*Personnel 1124-08 (6-Man Direct)</p> <p>*Launch Vehicle 1251-04 (188% Saturn V)</p> <p>*Braking Stage 1421-04</p> <p>*Landing Stage 1431-05</p> <p>*Earth Return Stage 1454-03</p> <p>*Command Module 1412-03</p> <p>*Logistics 1147-05 (27, 100 kg)</p> <p>Launch Vehicle 1251-04</p> <p>Braking Stage 1421-04</p> <p>Landing Stage 1442-08</p> <p>Unmanned Orbiter 1161-01</p> <p>Explosives Transport 1151-02</p> <p>Development Test Transport 1171-01 (Development Test of 1454-03)</p>	<p>LRV 2423-04 (a)</p> <p>LRV 2423-05</p> <p>LRV 2434-01</p> <p>LRV and Trailer 2434-02</p> <p>LRV 2511-02</p> <p>Shelter 2325-08 (2 each)</p> <p>Nuclear Supply 2722-04</p> <p>Unmanned Orbiter 2211-03</p>	<p>Drill 3213-02</p> <p>Radio Telescope 3222-01</p> <p>Radio Telescope 3223-01</p> <p>Radio Telescope 3224-01</p> <p>X-Ray Telescope 3231-01</p> <p>X-Ray Telescope 3231-02</p> <p>Optical Telescope 3242-02</p> <p>Optical Telescope 3242-05</p> <p>Optical Telescope 3243-01</p>

*Indicates New Development
 [] Indicates Principal Items Characterizing the Phase
 (a) Data Book identification number

Chapter 4

PLANNING CONSIDERATIONS

With an integrated scientific program defined (Chapter 2) and a specific set of exploration equipment selected (Chapter 3), it is now possible to proceed with an analysis of the major program shaping factors that must be considered in the formulation of a lunar exploration plan. Three critical decision points already have been tentatively identified (Fig. 1-1). The purpose of this chapter is to study these decision points in detail through an investigation of the alternate program options available and an analysis of the planning implications associated with each option. The results of these deliberations provide the basic elements essential to the formulation of a recommended approach to lunar exploration.

4.1 DECISION POINT 1

Decision Point 1 involves two options for continued lunar exploration: either continue with Apollo or introduce the Saturn/Apollo Application Systems (S/AA). It is assumed that a decision to proceed with with an S/AA lunar exploration program will be made in the near future. Thus, the main consideration associated with Decision Point 1 concerns what can be done with the S/AA systems potential and at what cost. Also, the S/AA activity forms the initial part of any exploration program, regardless of eventual equipment capability, so the definition of the early phase of exploration is an important first step.

The equipment suggested by NASA as representative of S/AA performance (Table 3-18) is typical and no attempt was made in the MIMOSA study to provide a capability comparison of the various candidates. The choice of the optimum set of S/AA equipment is important to the current planner, but the eventual choice will not significantly affect the long-range plan being developed here.

The S/AA portion of the exploration program is summarized in Fig. 4-1. It consists of three manned orbiter and four manned surface missions together with one unmanned photographic orbiter mission for the performance of the initial phase of the integrated science program. Twelve Saturn V launches are involved (logistics, personnel, and one test flight) in this program which provides 400 surface scientific manhours and 2,000 orbital scientific manhours for a total cost of \$6.8 billion.

Development schedules and cost* for the major items of equipment in the S/AA inventory are presented in Fig. 4-2. Initial commitment of funds occurs in FY 1968 for development of the 111 percent Saturn V and modification of the associated service module (SM). Annual and cumulative commitments are summarized through FY 1971 when the S/AA capability is fully developed and operational. When the cost of developing additional equipment items, such as scientific equipment, is added to the value quoted for major equipment, a total nonrecurring investment of \$0.9 billion is obtained. Total recurring costs of \$5.9 billion are associated with the procurement and operation of this new equipment during the period FY 1968 through FY 1975.

To ensure a smooth transition from Apollo to S/AA (CY 1971), Decision Point 1 occurs in CY 1967. However, as indicated in Fig. 4-2, the actual commitment of funds is spread over about four years with a maximum commitment (nonrecurring and recurring) of about \$1 billion in FY 1970. Maximum expenditure of nonrecurring funds is \$290 million and occurs in FY 1970.

4.2 DECISION POINT 2

In the broad spectrum analysis of candidate lunar exploration programs described in Vol 2, Decision Point 2 was determined to be critical because it represents the first opportunity to step up to a capability potential for extensive lunar surface exploration. Two major options are available to the planner: (1) continue at the S/AA level of limited locale type exploration, or (2) commit funds for new equipment to increase the

*All development schedule and cost data quoted in this volume refer to Phase D hardware development and do not include hardware program definition studies.

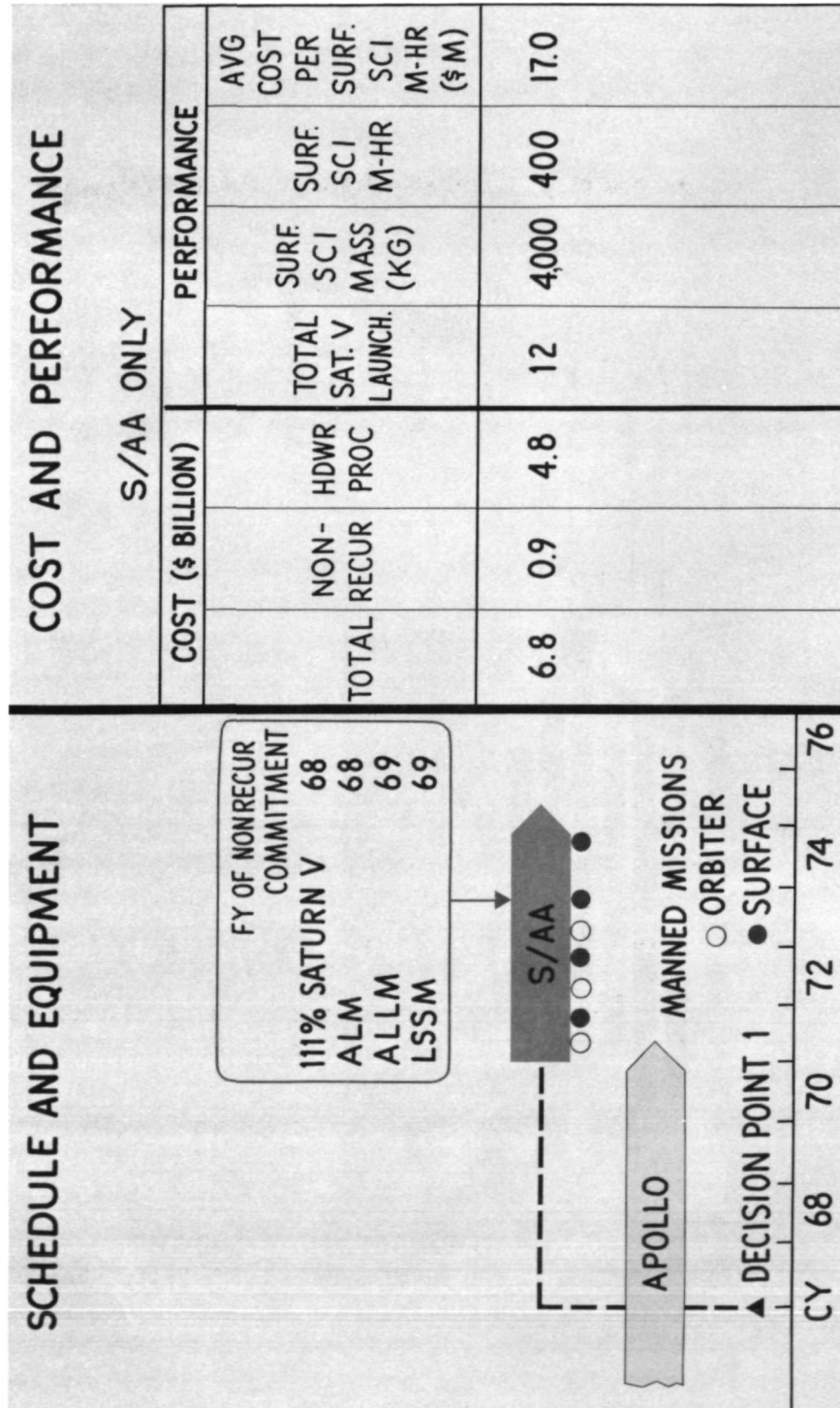

Fig. 4-1 S/AA Program - Decision Point 1

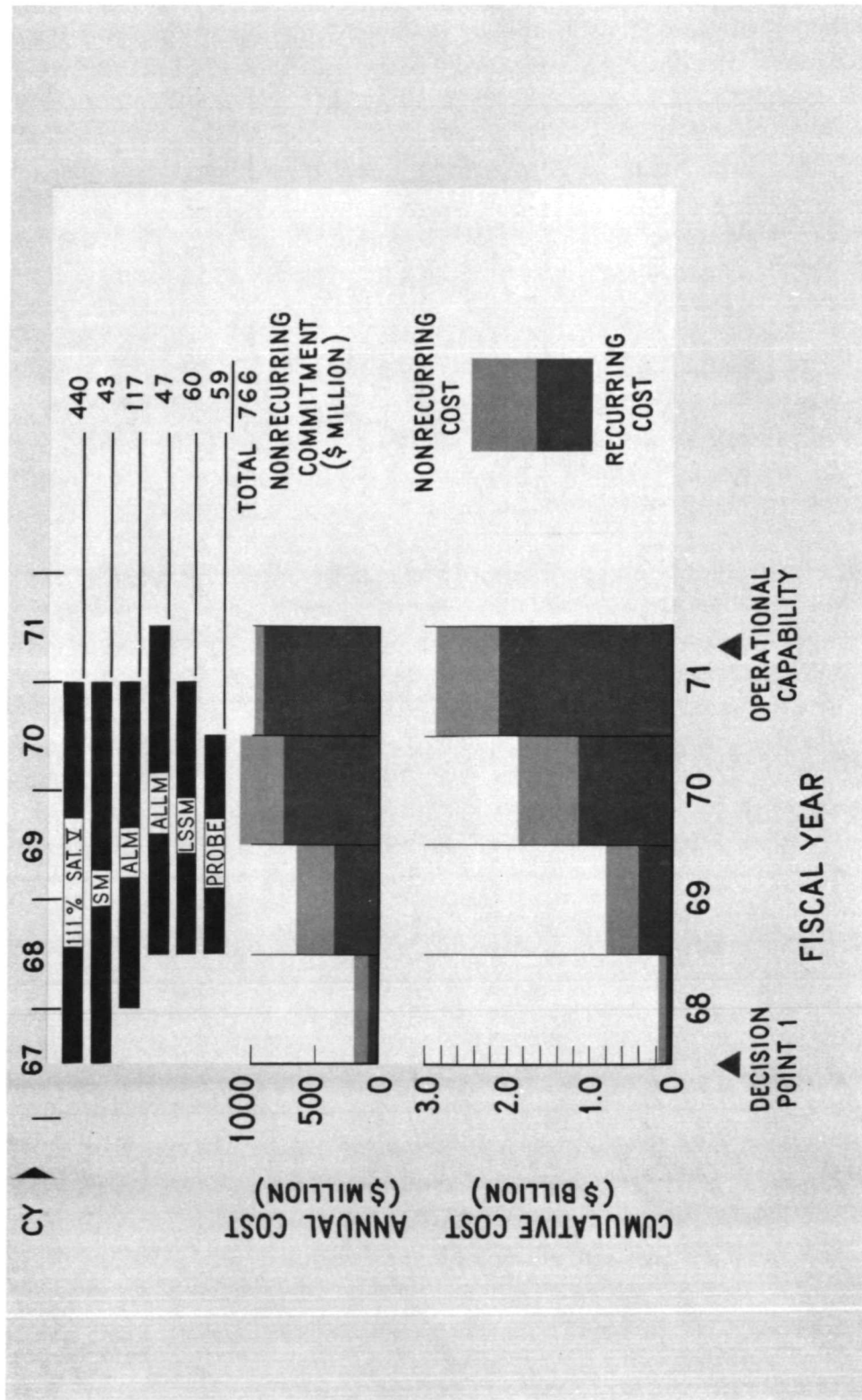

Fig. 4-2 Anatomy of Decision Point 1

exploration capability to the medium level. These capabilities are represented by the equipment selected in Chapter 3 (Table 3-18). The intent of an increase in capability is to:

- Permit extensive surface coverage through increased mobility.
- Achieve greater cost effectiveness through improved performance.
- Provide greater flexibility to meet an increasing scientific demand.

4.2.1 Alternate Programs

Utilizing each of the equipment options described above produces the alternate programs shown in Fig. 4-3. For comparison purposes, the two programs are shown extending over a 10-yr period; obviously, they could be shortened or extended at the planners discretion. Building onto the previously developed S/AA missions, each alternate program (i. e. , medium or continued S/AA) includes six additional manned missions. A significant improvement in operational performance is evident when the medium capability is utilized rather than continuing at the S/AA level, for approximately the same total program cost. The increase in capability available at the medium level permits the delivery of 50 percent more mission equipment and provides almost 3 1/2 times the total surface manhours than does the continued use of S/AA equipment. The improved capability of the medium level program is further illustrated by a comparison of scientific achievements, summarized in Fig. 4-4. Associated with the buildup of scientific manhours, achieved through the introduction of the medium capability systems, is an increase in the depth of scientific investigation associated with the introduction of the 300-m drill and more extensive seismic experimentation. Of principal interest, however, is the increased replications of basic experiments and the greater surface coverage associated with the medium level exploration.*

4.2.2 Funding Requirements

The annual funding rates to support these two programs are shown in Fig. 4-5. For the launch rates suggested by the guidelines (three or four Saturn V's per year through

* A more detailed comparison of the missions achieved in each program may be obtained by consulting the program data of Appendixes A and B.

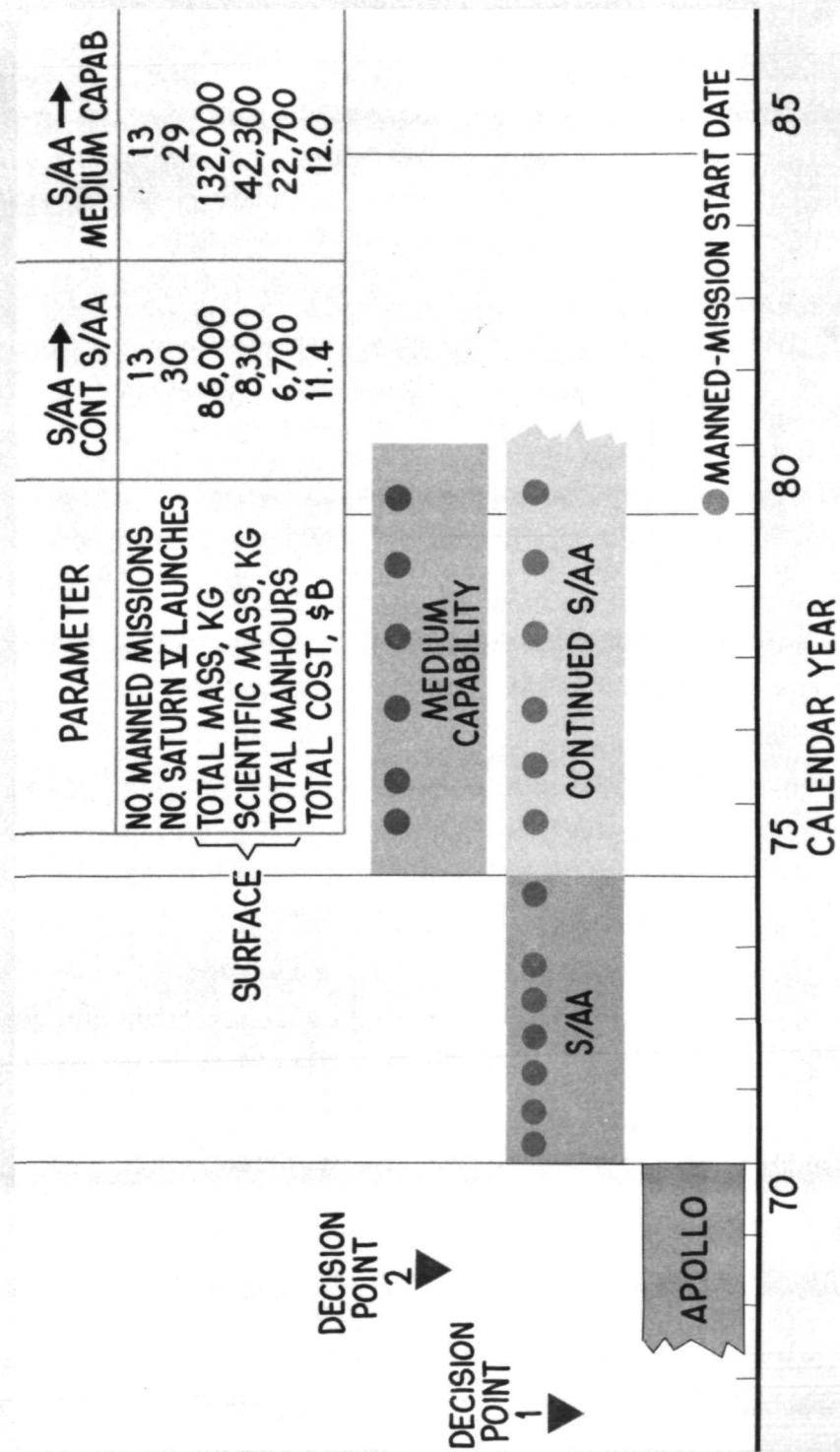

Fig. 4-3 Alternate Programs - Decision Point 2

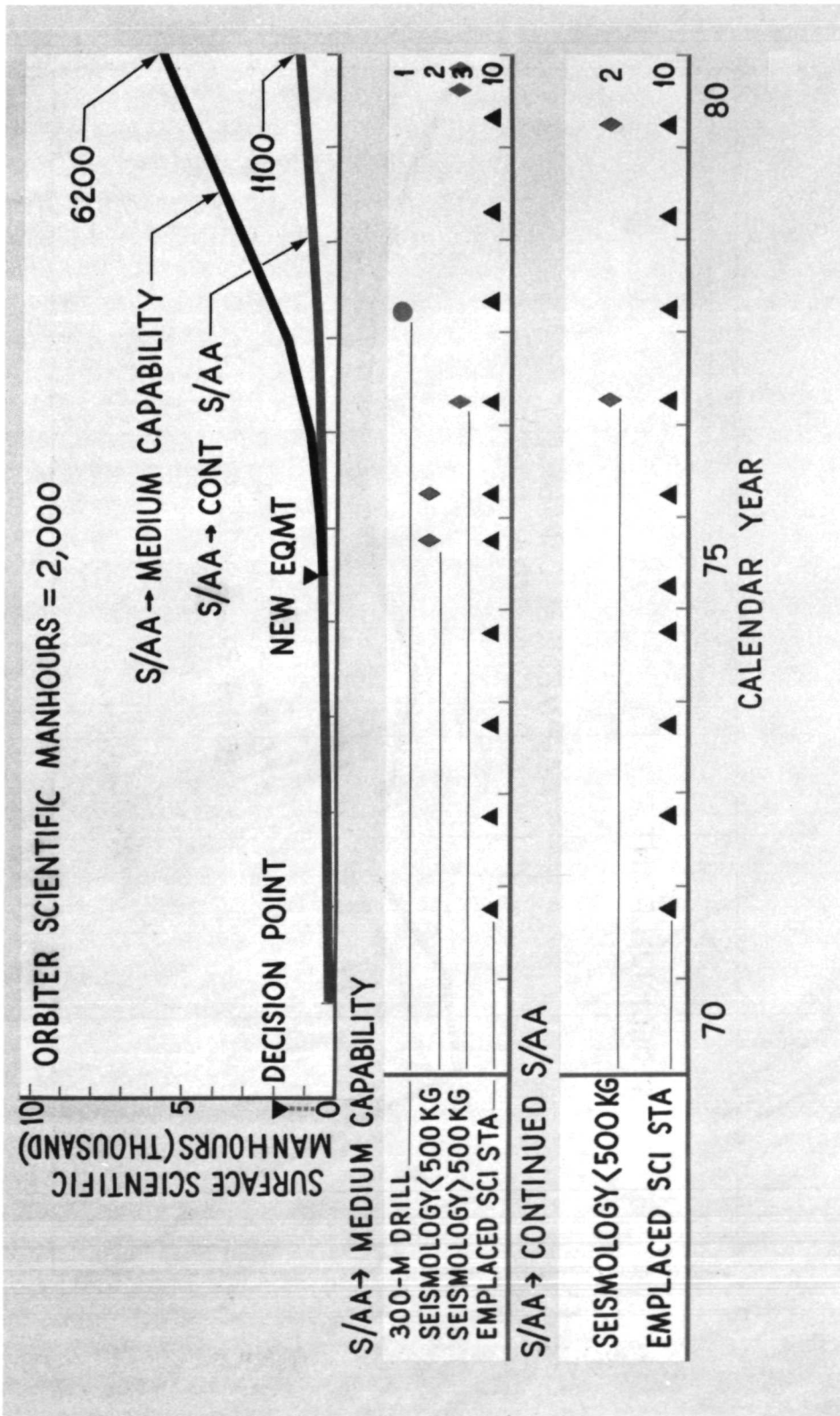

Fig. 4-4 Scientific Achievement - Decision Point 2 Programs

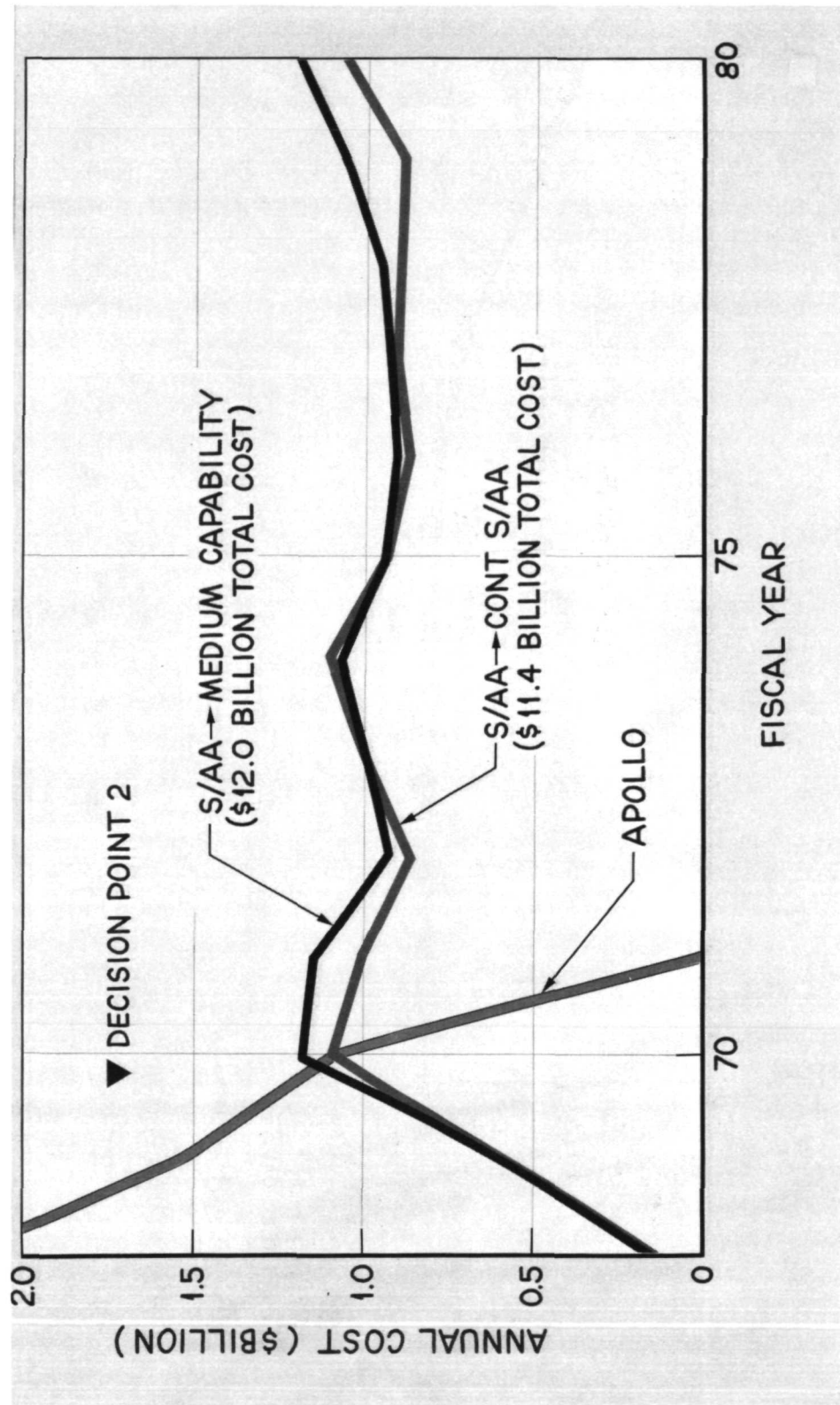

Fig. 4-5 Annual Funding Summary - Decision Point 2 Programs

the 1970's), the annual funding for both programs is about \$1 billion per year. The slightly higher rate associated with the medium program over the period FY 1970 to FY 1972 reflects the development of new equipment.

Program scientific return, in terms of potential manhours of surface scientific activity, is illustrated in Fig. 4-6 as a function of the cumulative total program spending. This allows comparison of the scientific effectiveness of the two candidate programs independent of arbitrary scheduling differences or mission planning peculiarities. A significant improvement in the efficiency of providing surface scientific manhours is evidenced by the abrupt change of slope of the medium capability curve. By FY 1980, the medium capability program shows a total expenditure of \$0.8 million to provide and support each surface scientific manhour. The cost of a scientific manhour for the continued S/AA program is about seven times this value.

The total program costs of about \$12 billion for both programs through 1980 are divided up as shown in Fig. 4-7. The S/AA portion that is common to both programs accounts for some 60 percent of the total. For the continued S/AA program, all the remaining funds are allocated to recurring procurement and operations. In the case of the medium capability program \$1 billion dollars of the remainder is invested in nonrecurring R&D. The residue of \$4.2 billion is spent on procurement and operation of the uprated equipment. It is this new equipment that permits the accomplishment of the significantly more extensive, and presumably more productive, scientific investigations of the medium level program.

4.2.3 Funding Commitments

An anatomy of Decision Point 2 is presented in Fig. 4-8 in terms of development schedules and cost for the major items of new equipment associated with the medium level program. As in the case of Decision Point 1, the commitment of funds at Decision Point 2 again takes place over a period of years rather than at one point in time. In accordance with the guidelines, no commitment to new developments is made until FY 1970. This means that the decision on the desirability of the increased capability

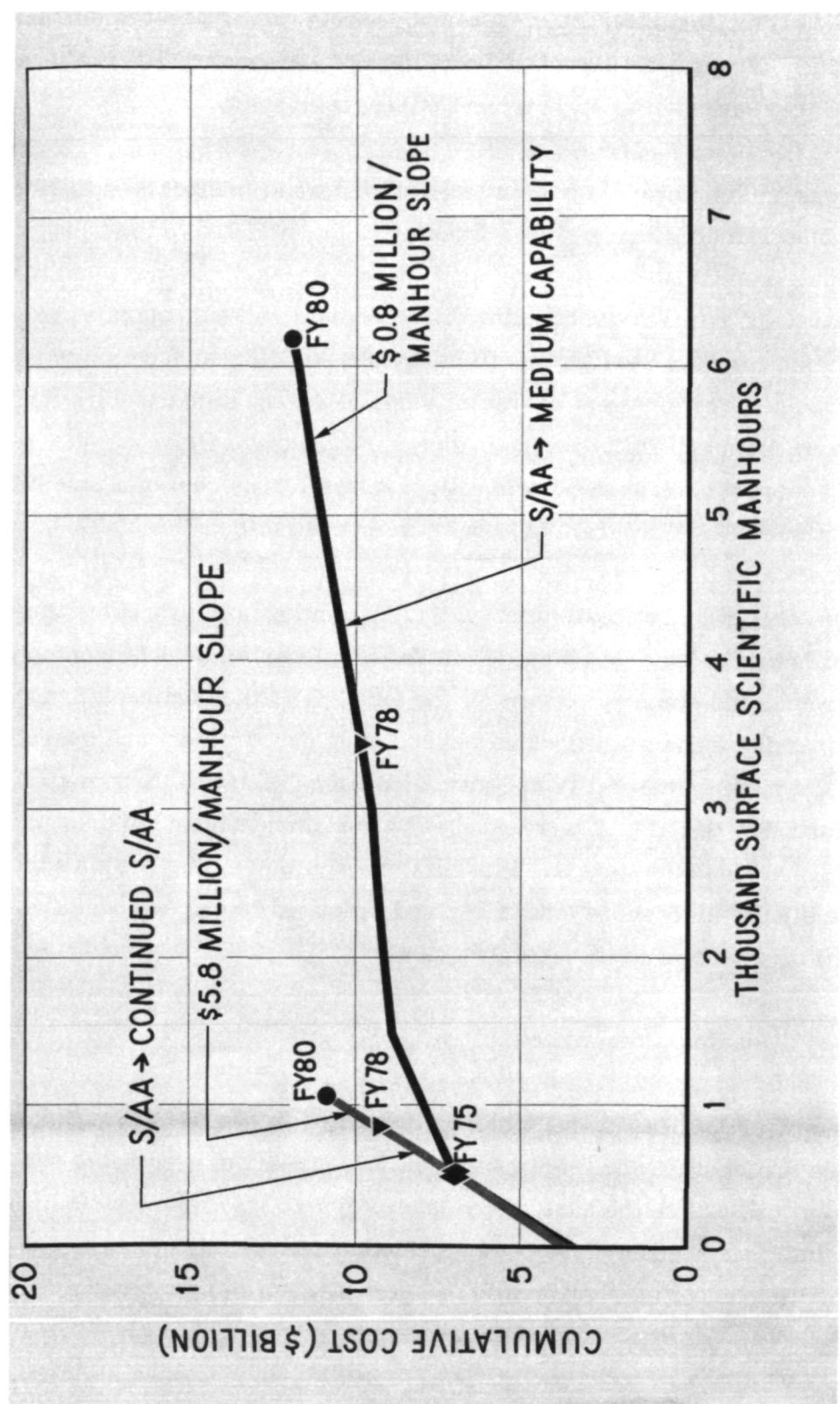

Fig. 4-6 Program Scientific Return - Decision Point 2 Programs

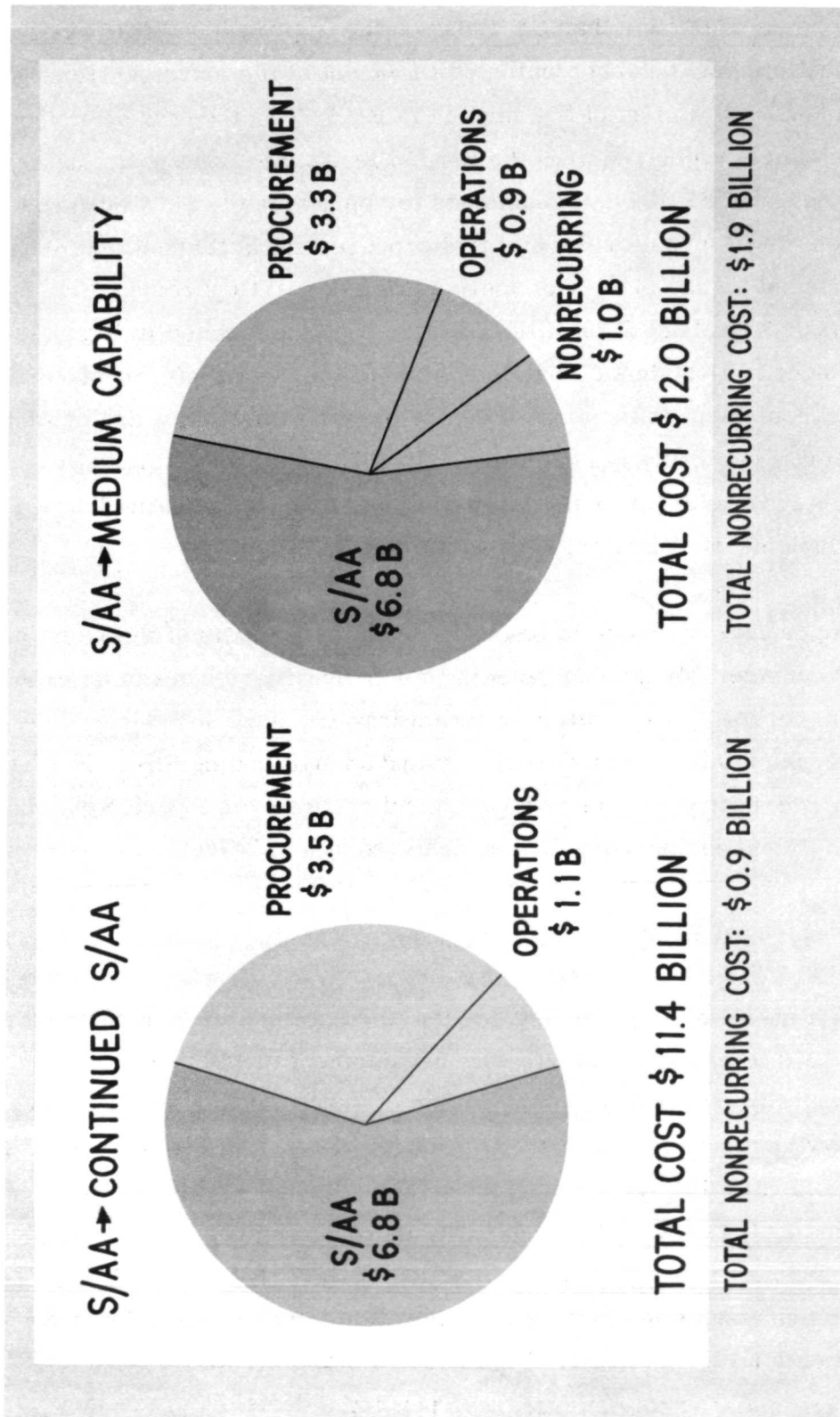

Fig. 4-7 Cost Breakdown Comparison - Decision Point 2 Programs Through Fiscal Year 1980

can be made no earlier than CY 1969. If the improved capability is desired, about \$875 million must be spent on the development of the principal items shown in Fig. 4-8. The initial commitment of \$50 million in FY 1970 is towards development of the large roving vehicle which requires the longest lead time. The peak funding for new equipment occurs in FY 1974, and amounts to approximately \$375 million. This figure includes initial funds for the eventual procurement of the new equipment as well as development funds. The peak nonrecurring dollar requirement also occurs in FY 1974, and amounts to about \$280 million for the equipment listed in Fig. 4-8. The cumulative investment is also shown as an indication of the "write-off" involved if development of the new equipment is terminated before operational returns are obtained. An initial operational capability is achieved by CY 1975 and full operational capability, which includes the availability of the large drill and extended mobility range through the use of a supplementary trailer, is possible in CY 1978.

The important conclusion to be drawn from the analysis of the Decision Point 2 options is that considerably greater potential for scientific return can be expected from the medium capability exploration program than from continued use of the S/AA capability for approximately the same total cost and annual funding level. Further, since the funding commitment to the new equipment occurs over a period of about seven years, this improved performance can be achieved at a relatively low investment risk.

4.2.4 Effect of Delay

The data given in the preceding section were predicated on a decision point occurring in CY 1969 to provide funds for new development in FY 1970. The utilization of the new capability resulted in the provision of 6,200 surface scientific manhours by CY 1980. It is now pertinent to ask what is the effect of delaying the decision to step up to the increased capability of the medium level equipment. The answer to such a question is provided by the data of Fig. 4-9. The increase in program cost to yield 6,200 scientific manhours is presented as a function of time of decision (FY). These results involve the assumption that lunar exploration is continued at the S/AA level during the period of delay. Of course, if the exploration is slowed down, a smaller penalty is incurred, and if exploration ceases, pending a decision, there may be no penalty; but there is no progress either.

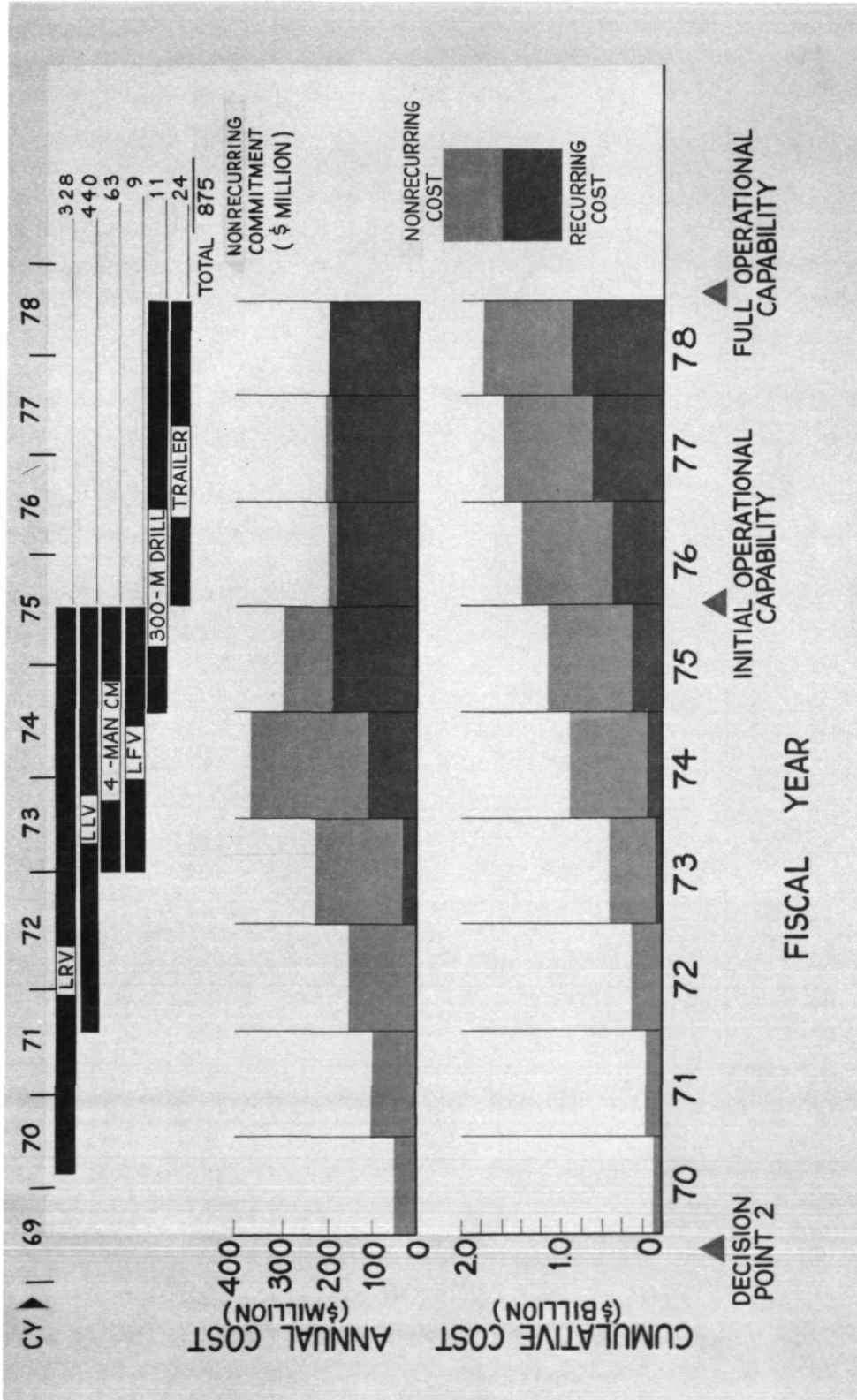

Fig. 4-8 Anatomy of Decision Point 2

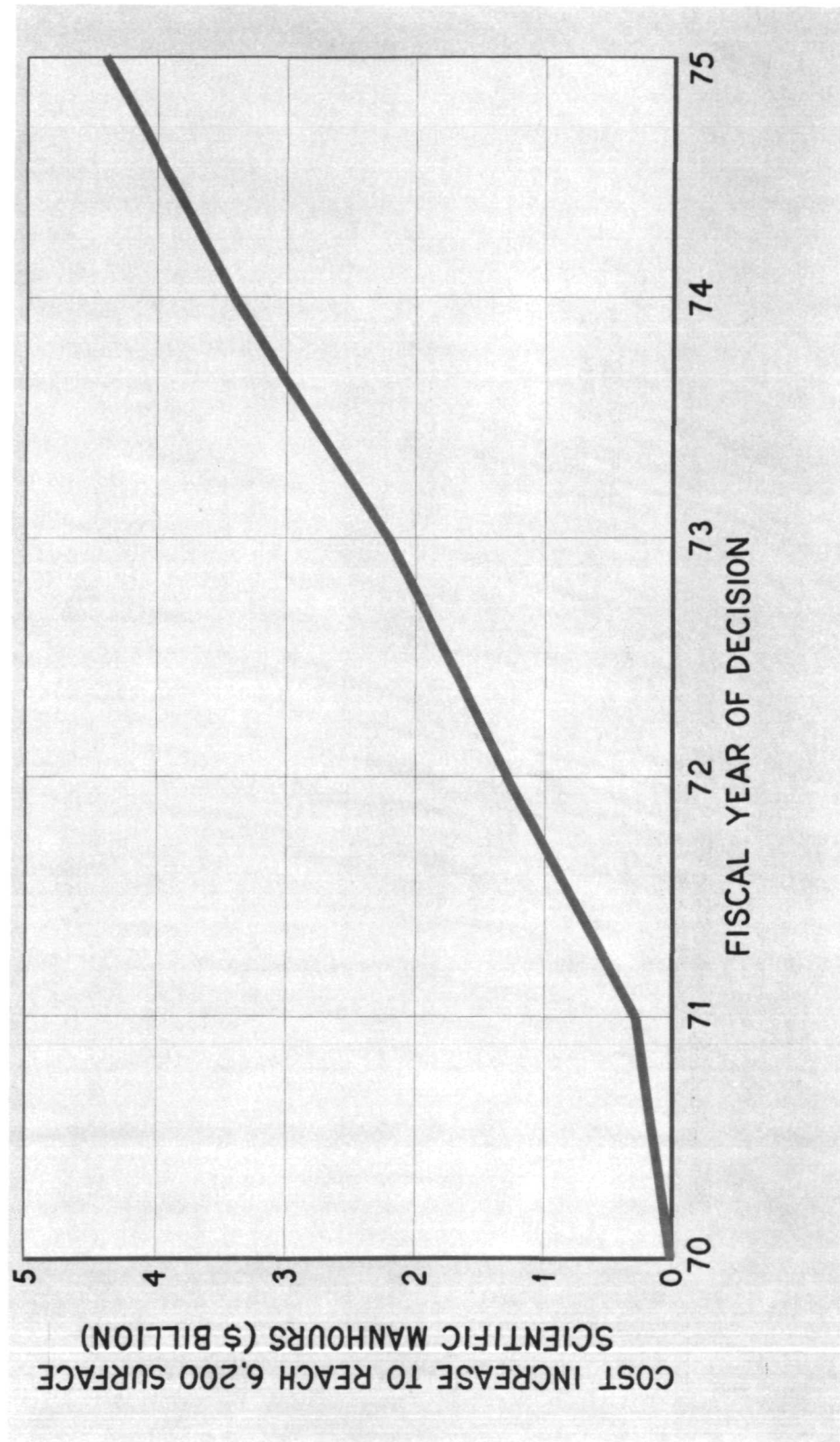

Fig. 4-9 Effect of Delaying Decision to Increase Capability - Decision Point 2

Based on the foregoing assumption, it can be seen that a five-year delay results in a program cost increase of \$4.4 billion or, on the average, a penalty of \$880 million per year. Thus, each year of delay accumulates an additional program cost that is approximately equal to the total nonrecurring investment required to provide the increased medium capability. Also, the year in which the 6,200 scientific manhours is achieved is delayed. If the stepup decision is delayed until 1975, the requisite scientific manhours are not realized until 1983, a delay of three years.

If a steady launch rate is to be maintained and the assumed scientific program achieved, these results clearly indicate that a decision to introduce the higher capability equipment should be made as soon as possible. Of course, this conclusion is dependent on the level of exploration activity envisaged. For the lowest funding level examined in MIMOSA - \$500 million per year (corresponding to a manned mission every other year), it was found that advantage can still be taken of the higher capability without a cost penalty.

4.2.5 Effect of Pickup Launch for Crew Return

The conservative approach taken in formulating an exploration program with the medium-level capability systems assumed that, for surface mission staytime exceeding 14 days, the crew would be picked up and returned to Earth through use of a separate pickup launch. This mode of personnel transportation involves two personnel system launches per mission with the pickup launch utilizing a four-man CSM. Since the transportation system is a major contributor to program cost, the use of a pickup launch incurs additional costs over the approach that uses a deactivated CSM in lunar orbit.

To ascertain the magnitude of the cost penalty associated with the utilization of the pickup launch, the medium-level exploration program was restructured using a deactivated, three-man CSM in lunar orbit for all missions in the period of interest. A cost comparison of the two programs using the alternate crew return techniques is given in Fig. 4-10. Eliminating the pickup launch reduces program costs by about \$300 million per year and reduces the total cost by \$1.4 billion over the ten-year period. This magnitude of cost saving justifies a concerted development effort towards a solution of the operational problems associated with the long-time deactivated CSM. The

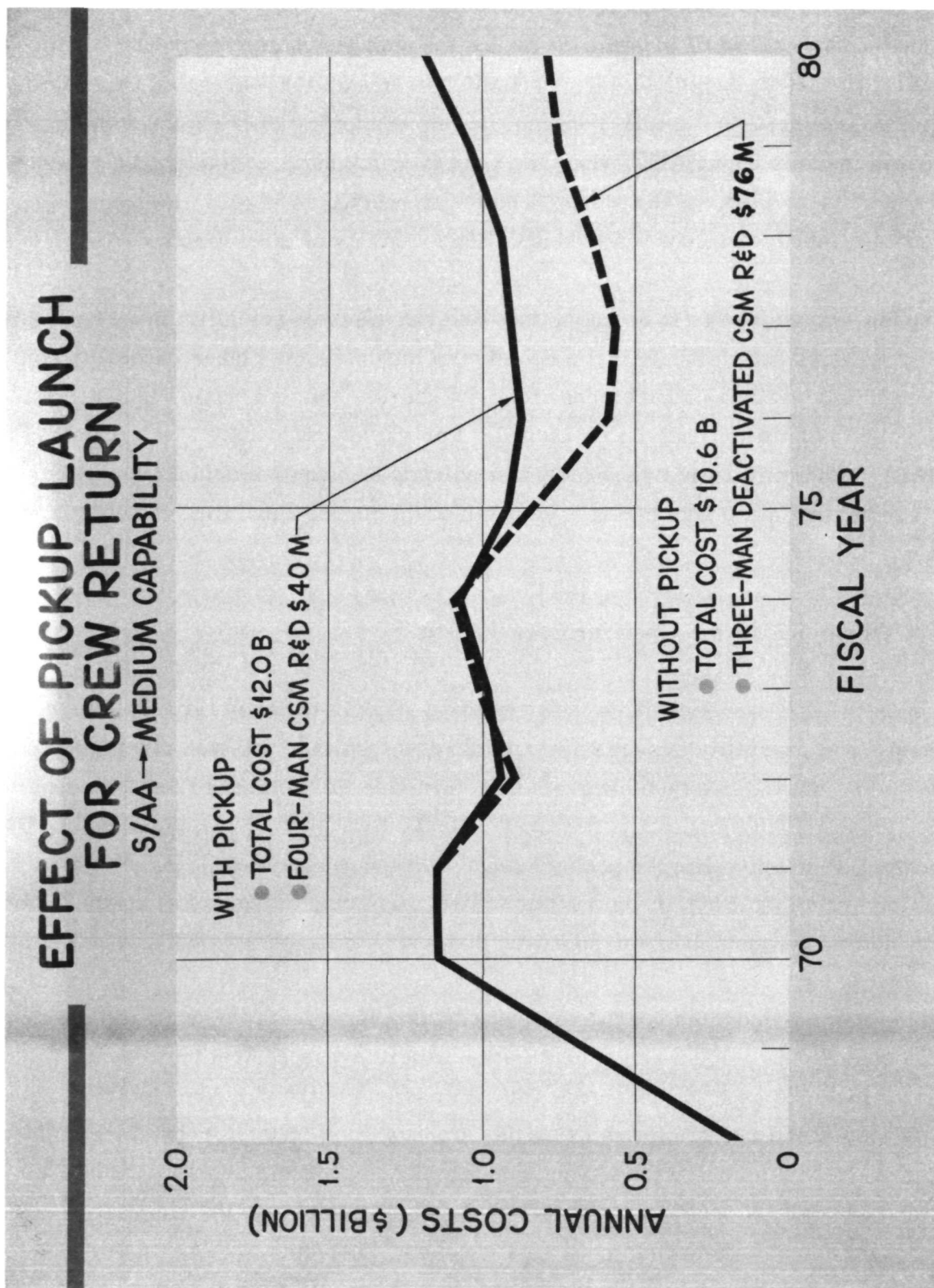

Fig. 4-10 Effect of Pickup Launch for Crew Return - S/AA → Medium Capability

potential cost savings with a one-launch capability are considerably increased if the medium level equipment is utilized beyond 1980 as discussed in the following paragraphs.

4.3 DECISION POINT 3

The environment influencing the deliberation concerned with Decision Point 3 is not clearly definable at present. Certainly, the needs of a manned planetary program might be an important planning factor. Such a program would strengthen the requirement for a large capability, uprated Saturn V launch vehicle. Thus, one option likely to be available to the lunar planner is to increase the scope of lunar exploration through the introduction of large capability systems (as defined in Table 3-18). This would ensure completion of the integrated scientific program through the provision of a large (12-man), extended base capability and provide flexibility to possible requirements for greater exploration of the Moon itself. Alternatively, the option is available to continue exploration with the basic medium capability equipment. However, this equipment must be supplemented by the addition of a six-man shelter, a nuclear power supply, and some major scientific equipment to provide an extended base capability at the six-man level.

4.3.1 Alternate Programs

Examining each of these options results in the alternate programs given in Fig. 4-11. Lunar exploration is now extended into the late 1980's, and the optional scope is greatly enlarged. Each program accomplishes 21 manned missions at a rate of approximately one mission per year. There is a six-man base at the continued medium capability level and a 12-man base at the large capability level; the latter employs a six-man direct delivery system for personnel rotation every six months. Reference to Fig. 4-11 shows that the investment in the development of the higher capability system is beneficial. Use of the 188% Saturn V and its associated systems yields more total manhours and delivered mass with fewer launches than is possible at the continued medium capability level. The total program cost for the large capability program is \$22.9 billion compared with \$23.8 billion for the continued medium capability program; i.e., the additional development costs are more than amortized by the reduced operational costs. However, it must be noted that about \$3.5 billion of the medium program dollar requirements results from the continued use of the pickup launch for the LOR return of the three-man surface crew.

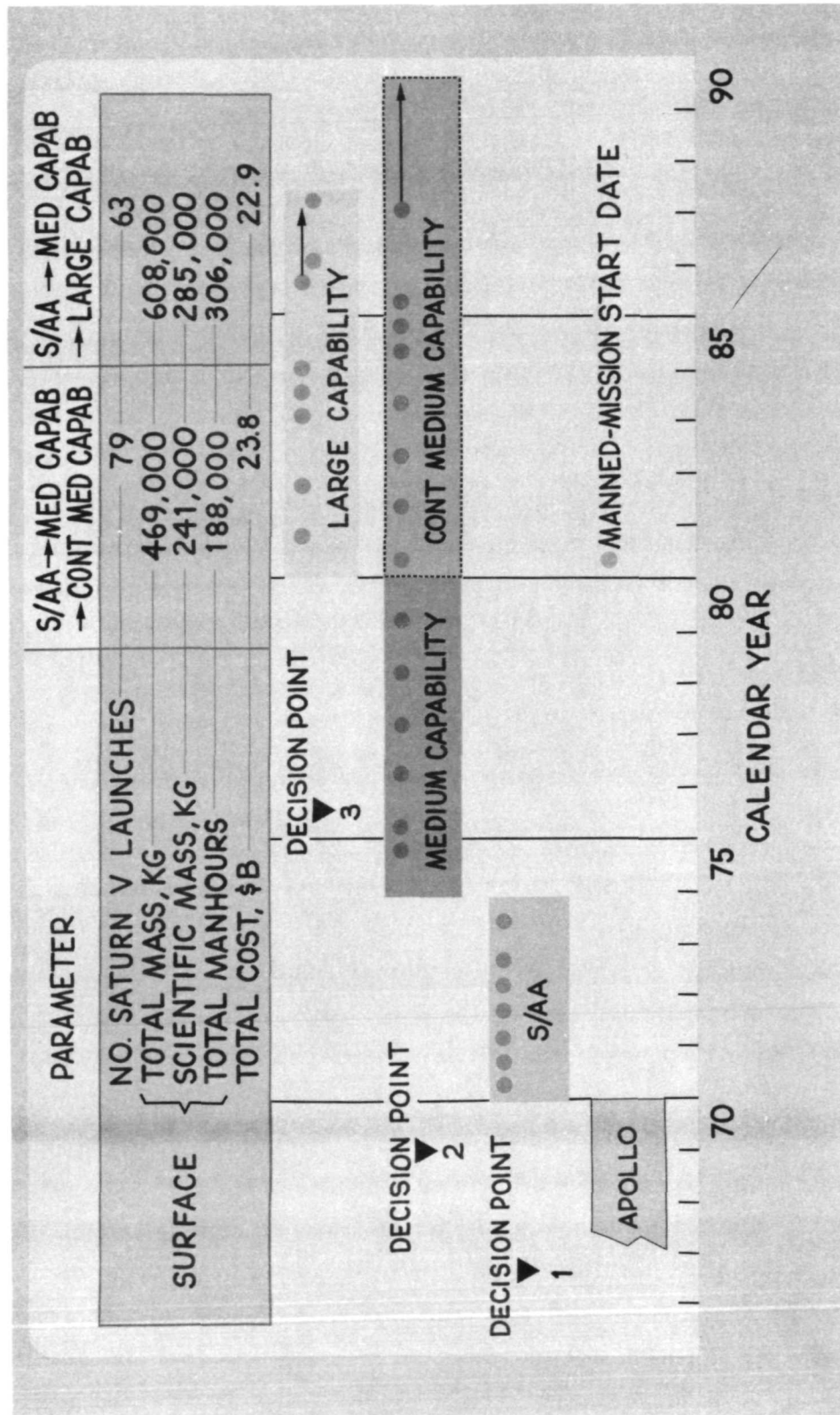

Fig. 4-11 Alternate Programs - Decision Point 3

Scientific achievement for both programs is presented in Fig. 4-12. The continued use of the medium capability results in a total potential of 56,000 surface scientific manhours. It includes one six-man astronomical base extending over a period of 2 1/2 years, five 300-m drillings, and eight major active seismology experiments. The large capability program can complete the entire integrated science program by CY 1988 which requires 97,500 scientific manhours on the surface. This program includes one extended 12-man base (approximately two years) and three six-man bases of about six-mo duration, ten 300-m drillings, and ten major active seismology experiments.

4.3.2 Funding Requirements

The funding requirements to maintain each program are given in Fig. 4-13. The continued medium capability program funding rate is always less than the guideline value of \$1.5 billion per year even though the Saturn V launch rate is increased to six per year in the 1980's. The large capability funding history has a peak in FY 1980 slightly in excess of the \$1.5 billion value due to the development costs for new hardware. The peak in the cost curve of Fig. 4-13 is almost entirely removed if a certain degree of cost sharing with a planetary program is assumed. Major equipment items that exhibit commonality with a planetary program are the 188% Saturn V, the six-man CM (used as an Earth return vehicle) and the six-man shelter which might be used as an integral part of the planetary mission module. To examine the effect of sharing nonrecurring costs with a planetary program, it was assumed that the planetary program provides the Saturn V uprating, and only the cost of modifying planetary hardware to provide a six-man CM and lunar shelter is charged to the lunar program. The resulting saving to the large capability lunar program is summarized in Table 4-1.

4.3.3 Funding Commitments

Since both options available at Decision Point 3 involve new hardware commitments, two cost and schedule anatomies must be considered. The total nonrecurring cost

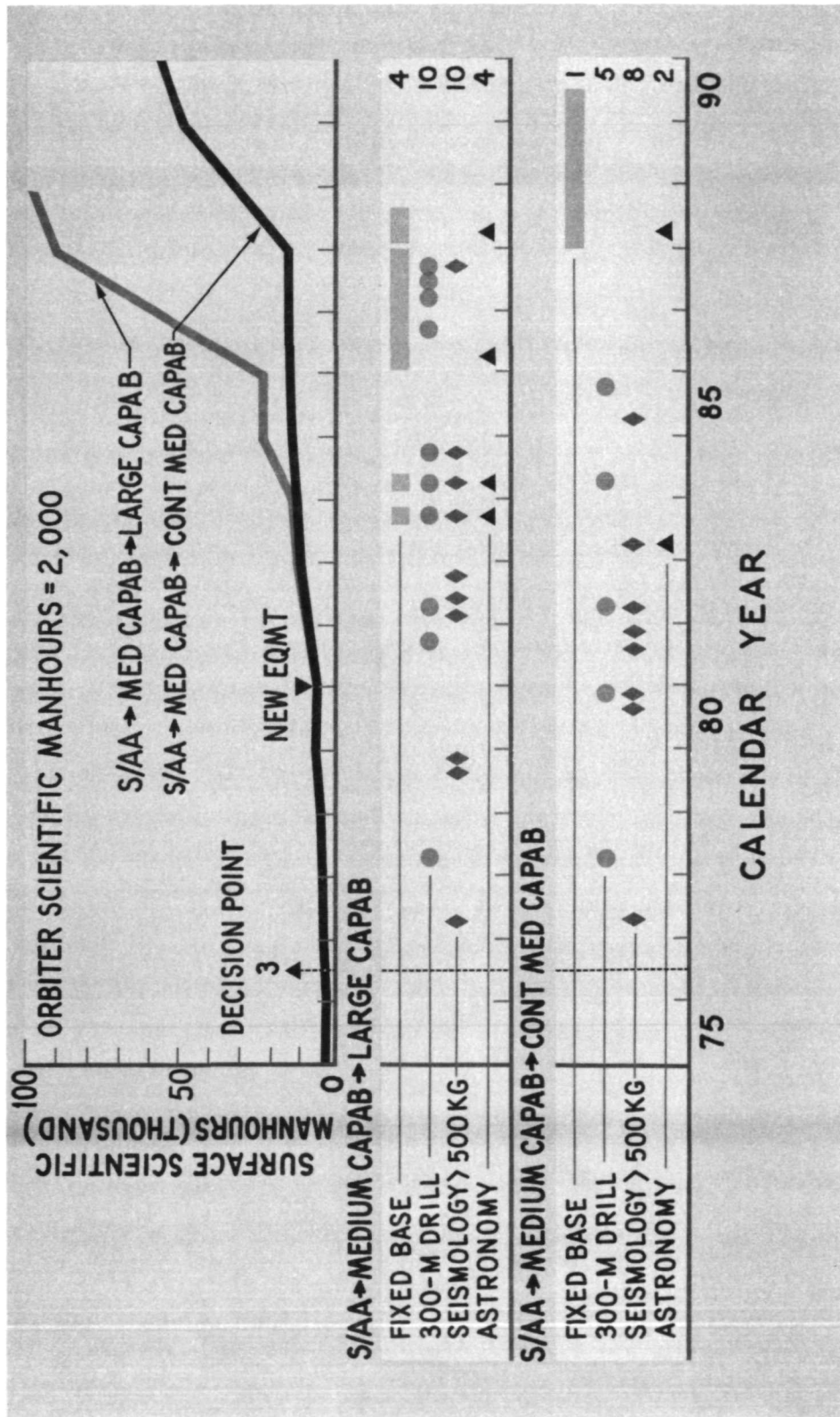

Fig. 4-12 Scientific Achievement - Decision Point 3 Programs

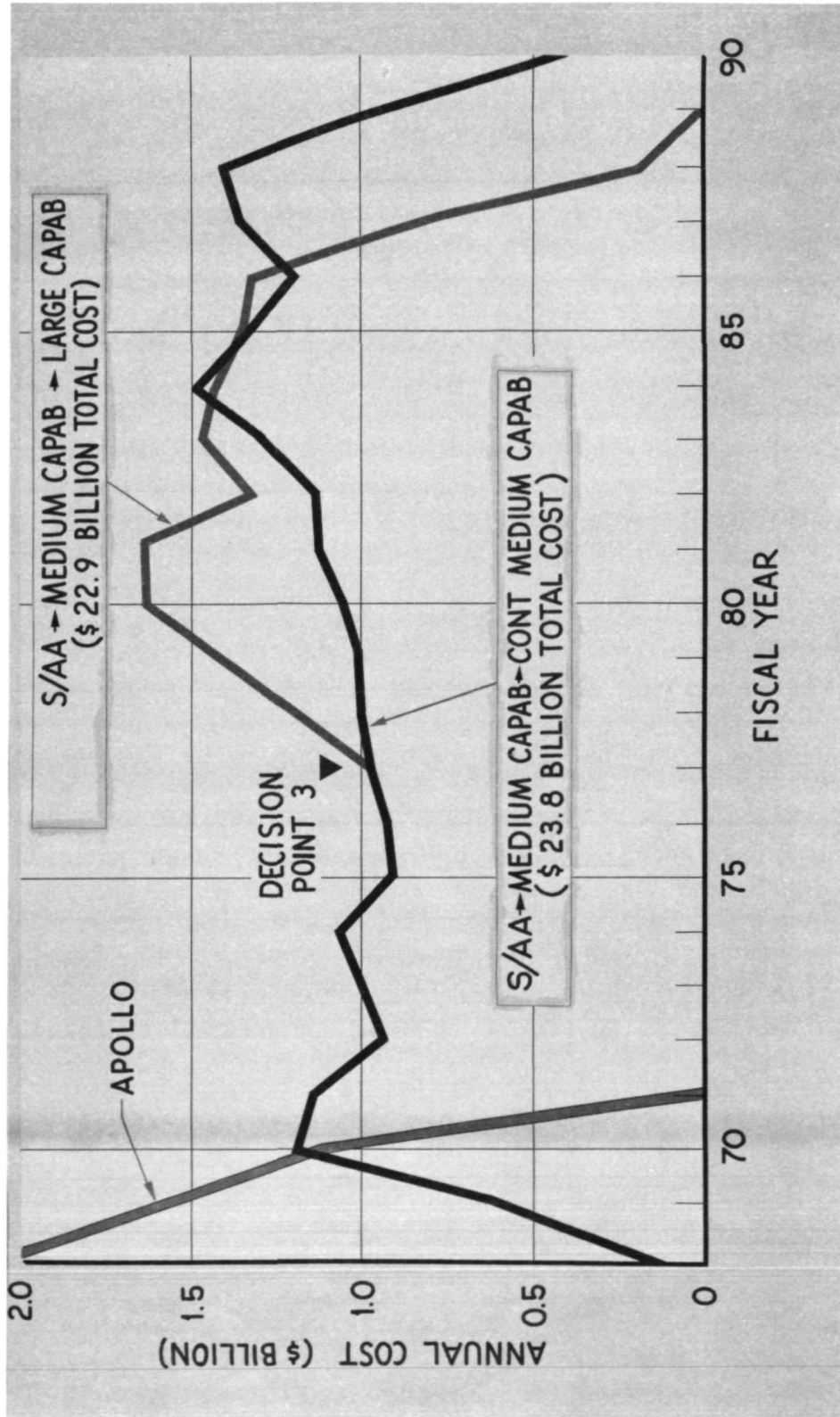

Fig. 4-13 Annual Funding Summary - Decision Point 3 Programs

Table 4-1

LUNAR PROGRAM COST SAVINGS DUE TO COMMONALITY
 WITH PLANETARY PROGRAM

Equipment	Nonrecurring Cost Savings	
	(%)	(\$M)
188% Saturn V	100	984
Six-Man CM	75	382
Six-Man Shelter	75	316
Total		1,682

associated with continued medium exploration is about \$0.9 billion and is distributed among the new equipment shown in Fig. 4-14. The large (2.5-m diameter) optical telescope represents the longest lead time item and development is started in 1979 for a first mission use in 1986. The large capability is attained through an investment of \$2.8 billion in nonrecurring activities (assuming all costs are borne by the lunar program) distributed as shown in Fig. 4-15. Peak funding occurs in the years 1980 and 1981 at a total rate (nonrecurring and recurring for new hardware) of about \$1.4 billion; the peak nonrecurring dollar requirement occurs in 1980 and amounts to \$880 million.

The timing of Decision Point 3 is not critical as the large capability can not be fully utilized until extended base operations are introduced (compare the scientific manhours of Fig. 4-12). The general objective was to introduce the large Saturn V in the early 1980's. (This date is compatible with present predictions for a planetary program and also ensures about five years of usage of the medium level equipment.) This is possible in 1982 if the funding rate requirement is not to be disturbed significantly. To meet this schedule, Decision Point 3 must occur in CY 1976.

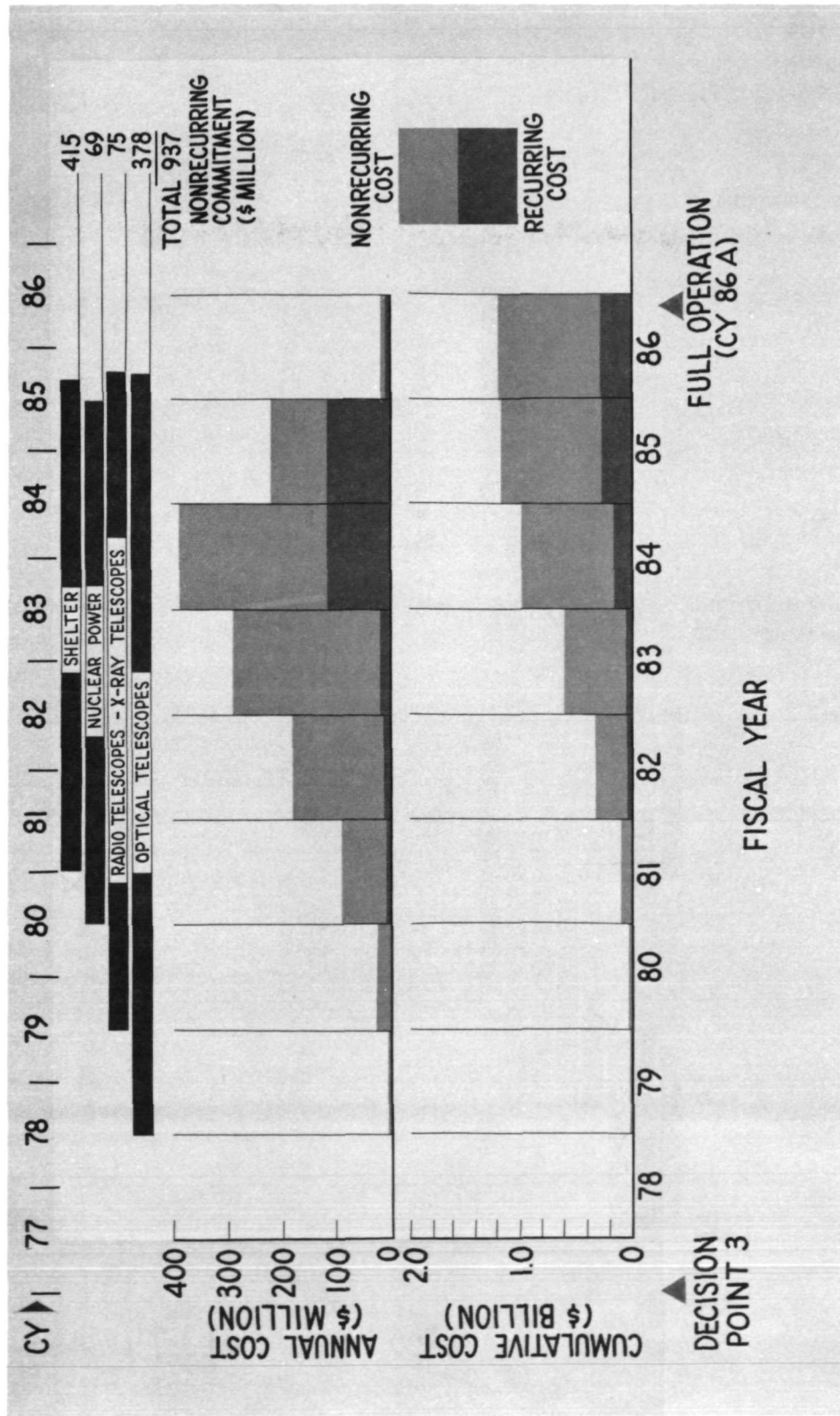

Fig. 4-14 Anatomy of Decision Point 3 (Continued Medium Capability)

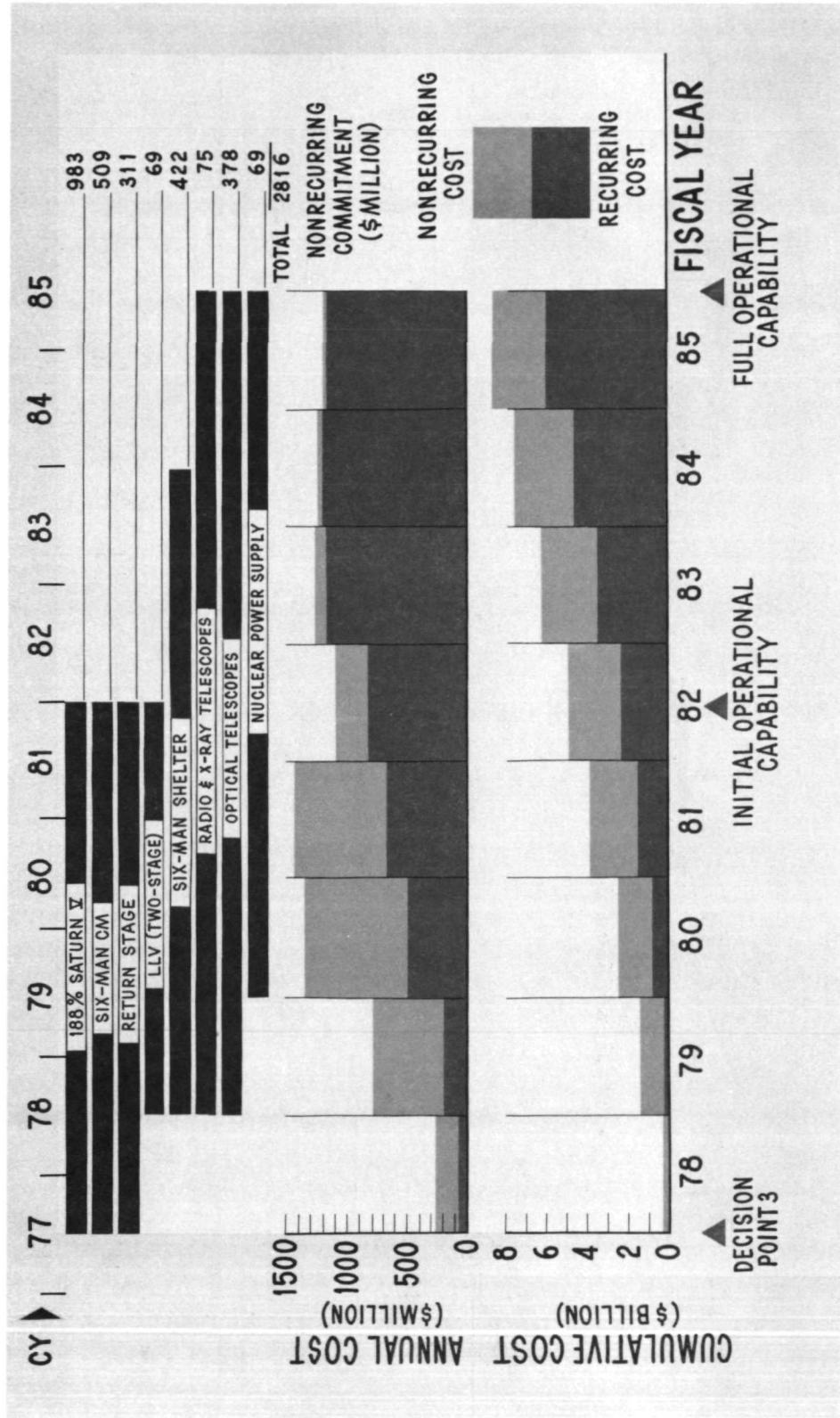

Fig. 4-15 Anatomy of Decision Point 3 (Increase to Large Capability)

4.4 POTENTIAL LUNAR EXPLORATION PROGRAMS

The recommended plan for lunar exploration as presented above advocates not one single program with a specific hardware evolution, but a number of program alternates associated with equipment and science options at three key-decision points over the next 10 to 15 years. The resulting lunar exploration program will depend upon the decisions made and the timing of those decisions. Figure 4-16 presents three examples of the type of program that could result from the decision alternates.

4.4.1 Exploration Program Descriptions

Exploration programs I, II, and III, as shown in Fig. 4-16, represent the result of three distinct passes through the recommended plan, yielding different levels of lunar exploration. Each program has a distinct science accomplishment (Scientific Programs I, II, III of the integrated science program, respectively), a distinct equipment evolution, and a distinct resource allocation requirement.

Exploration program I results from the development of an S/AA capability at Decision Point 1 and a decision at point 2 to continue with that capability. All missions are accomplished using Apollo techniques for crew and cargo delivery. All missions are locale-type, with 10 to 20 km radius of operation accomplished by two men on the surface. As presented here, Program I consists of 27 post-Apollo missions from 1971 through 1984 with only 14 missions involving manned landings. Exploration program I offers 4,200 scientific manhours of which almost 50 percent are associated with the three-manned orbiter missions.

Exploration program II typifies the kind of program resulting from a commitment to a large roving vehicle and direct unmanned cargo delivery beginning in 1975 supplemented by a six-man shelter with separate nuclear power supply in 1986. The program consists of 34 post-Apollo missions from 1971 through 1989 of which 18 involve manned surface activity. This program involves almost 10,000 km path-type explorations plus the establishment of a six-man astronomical base at Grimaldi for 2 1/2 years.

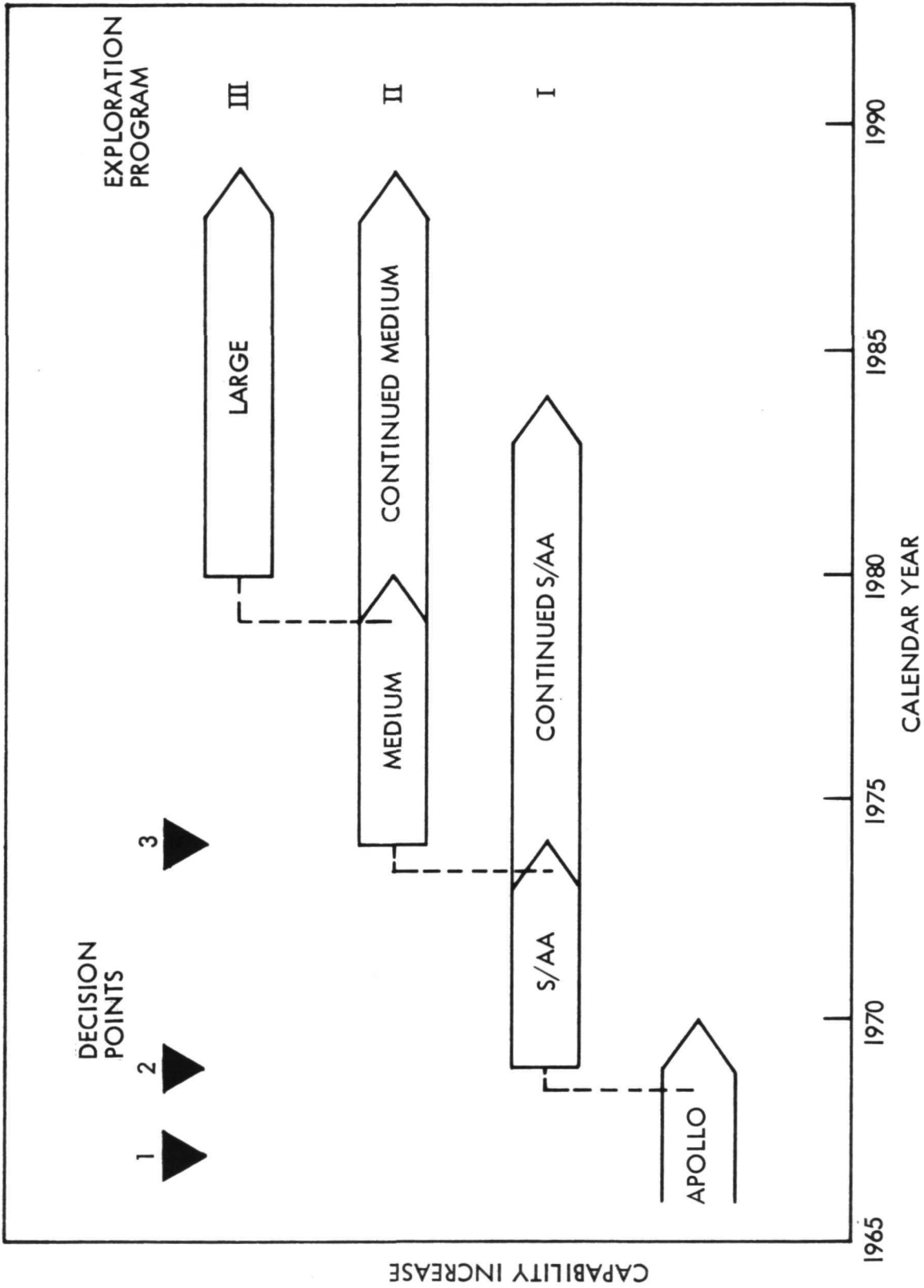

Fig. 4-16 Example of Lunar Exploration Programs Resulting from Recommended Plan

Exploration program III is typical of a large-scale effort at lunar exploration. It involves the same equipment as Program II plus the introduction of a 188% Saturn V for direct delivery of six-man crews. As a result, Program III accomplishes the same path exploration as Program II, but places increased emphasis on base-type activity. Four temporary bases are established: two at Grimaldi, one at the South Pole, and one at the center farside. One of the Grimaldi bases involves 12 men for two years performing astronomy, biology, and applied science experiments. As presented here, Exploration Program III contains 34 separate post-Apollo missions, including 18 manned-surface missions, performing almost 100,000 manhours of scientific activity.

Appendixes A and B present details of the three exploration programs and their associated scientific programs. Appendix A illustrates the scientific requirements of the integrated science program and the manner in which the missions were planned for each exploration program. Appendix B summarizes cost and schedule information and the important mission and equipment usage data of each exploration program.

4.4.2 Program Accomplishments

A quantitative statement of the anticipated accomplishments of the integrated scientific program is given in Appendix A by enumerating the individual experiments performed on each mission and the number of times each experiment is repeated. This information is given in the format used by the mission planner for mission-mode matching. The data in the table consists of the following: the equipment mass and approximate manhours required for one replication of each experiment, the total number of replications of each experiment in the program, and the number of replications of each experiment on each mission. Open-ended experiments, such as those for permanent bases and astronomy, have the required manhours expressed on a monthly basis. In these cases, the number of replications on a mission represents the number of months the group of experiments is counted as a part of the program. The set of notes appended to the tables advises the mission planner concerning the distribution of certain experiments in time and location.

It will be remembered that the total integrated scientific program is Scientific Program III. The program options, to continue at the S/AA level (Scientific Program I) and at the medium level (Scientific Program II) of exploration system capability, are also given in Appendix A.

The distribution of scientific equipment mass delivered to the Moon and scientific man-hours invested in experiments for each of the principal scientific disciplines are given in Table 4-2 for Exploration Programs I, II, and III. The geosciences and astronomy are the major consumers of mass and manhours in Program II and Program III, while at the S/AA level geosciences virtually stand alone because the extralunar goals of astronomy are not a part of that program. Although Program II and III do not differ greatly in total amounts of scientific equipment, there is a large difference in scientific manhours budgeted. The 12-man, semipermanent base of Program III allocates a great deal more time to the use of lunar-based astronomical facilities than does the six-man, semipermanent base compatible with the continued-medium level equipment.

In conclusion, the program accomplishments may be summarized in broad terms as follows: Exploration Program III, based upon the level of exploration associated with the large capability systems, undertakes a total exploitation of the advantages offered by the Moon in pursuing extralunar as well as lunar-scientific goals. It attacks the 15 basic questions about the Moon by integrating lunar-orbital and lunar-surface operations, using both the local and the path exploration approaches on the surface. It concludes as an open-ended program with a 12-man, semipermanent lunar base devoted to long-range exploitation of the Moon in pursuit of extralunar goals.

If the option to implement the large capability equipments and pursue aggressive extralunar goals, represented by the complete integrated science program, is declined and the lunar exploration program continues to depend on the medium capability systems, then essentially the same objectives as regards the Moon itself (the 15 basic questions) will be achieved. The important difference, scientifically, between Programs II and III is the considerably less extensive basing activity available with the continued-medium, Program II, option.

Table 4-2
DISTRIBUTION OF SCIENTIFIC EQUIPMENT AND MANHOURS FOR EXPLORATION PROGRAMS I, II, III

Category	Minor Equipment Mass, kg			Manhours		
	Exploration Program			Exploration Program		
	Large (III)	Continued Medium (II)	Continued S/AA (I)	Large (III)	Continued Medium (II)	Continued S/AA (I)
Geoscience	25,400	23,400	16,900	37,100	22,100	3,200
Particles and Fields	3,500	3,500	3,800	3,000	2,200	200
Biology	800	800	200	2,700	400	30
Astronomy	6,100	6,100	300	48,700	27,200	100
Engineering Sciences	2,700	2,700	700	8,000	6,000	600
Totals	38,500	36,500	21,900	99,500	57,900	4,130
Category	Major Equipment Mass, kg					
Deep Drills	56,000	35,000	-			
Telescopes	98,000	95,000	-			
Totals	154,000	130,000	-			
Explosives	47,500	41,700	14,300			
Grand Totals	240,000	208,200	36,200			

Lunar exploration, utilizing the low level or S/AA system capability, alone can undertake to answer all 15 of the basic questions, but does so without the advantages of the path approach to exploration associated with a significant surface-mobility capability. The degree of confidence in the results is, therefore, considerably less than for the other programs because Program I must depend very much upon extrapolations of lunar orbital survey data to characterize the total surface of the Moon. The restriction to a locale range of ground truth calibration of orbital data does not provide nearly as much statistical confidence as does the more comprehensive sampling of surface properties permitted by the path approach. The S/AA level program performs feasibility investigations associated with pursuit of extralunar goals, but does not attempt to establish any scientific facility for long-duration observations and investigations.

4.4.3 Exploration Program Comparison

Table 4-3 compares the three typical programs. Note that Program II requires a non-recurring investment of \$1.9 billion for 13 new equipment items over and above that needed for Program I. However, with the more capable equipment, Program II accomplishes over 25 times the surface scientific manhours of Program I and yields over 14 times the delivered scientific mass. These significantly increased accomplishments are achieved for an expenditure 1.6 times the cost of Program I.

Program III accomplishes approximately twice the scientific manhours of Program II, primarily due to the operations associated with the 12-man, 2-year base. Program III also results in delivery of 65 percent more total mass and almost 20 percent more scientific mass than Program II. It has all of this extra capability at \$0.8 billion lower total cost than Program II. This lower cost results mainly from the reduced number of Saturn launches required for Program III because of the more efficient crew transportation available with the 188% Saturn V.

The Program III systems allow six men to be transported to and from the Moon with one uprated Saturn V launch, whereas, the pickup mode of Program II requires two launches of the Saturn to transport only three men to and from the surface. As

Table 4-3
COMPARISON OF LUNAR PROGRAMS

Program Parameter (Post Apollo)	Programs		
	I	II	III
General:			
Program start date (yr)	1971	1971	1971
Program end date (yr)	1984	1989	1988
Number of missions	27	34	34
Number of manned surface missions	14	18	18
Total manhours on surface	18,000	188,000	306,000
Total mass delivered to surface (kg)	132,000	469,000	608,000
Maximum surface crew	2	6	12
Science Accomplishment:			
Science manhours - surface	2,200	56,000	97,500
Science manhours - orbit	2,000	2,000	2,000
Science manhours - at base	0	41,000	86,000
Science mass - surface (kg)	17,000	241,000	285,000
Science mass - orbit (kg)	5,500	5,500	5,500
Number of extended bases	0	1	4
Traverse range (km)	3,100	9,700	14,700
Resource Allocation:			
Number of new equipment starts	11	24	29
Total Saturn V launches	45	79	63
Total program cost (\$B)	14.8	23.8	22.9
Nonrecurring cost	0.9	2.8	4.7
Recurring cost	13.9	21.0	18.2

previously discussed, Program II costs could be cut by \$3.5 billion if special backup launches for crew return were eliminated. This would partially reduce the disparity in the effectiveness between these schemes.

Figure 4-17 compares the cumulative cost vs. cumulative scientific manhours for Programs I, II, and III. The figure also indicates the years in which various manhour values are achieved. The relative timing of the three key decision points is also shown.

Three observations can be made from Fig. 4-17. First, Program II offers more scientific manhours per dollar spent than Program I; the crossover occurs in 1976, one year after introduction of the medium capability equipment resulting from Decision Point 2. Second, Program III offers more scientific manhours per dollar spent than Program II, but only after introduction of large base activity in the mid-1980's. Third, the average performance data, representing ratios of final program cost to final scientific manhours, indicate that the programs providing more manhours per launch than S/AA can cut the cost per manhour by factors of 15 to 30.

4.5 IMPLICATIONS OF RECOMMENDED EXPLORATION PLAN

The recommended lunar exploration plan presented here advocates exploring the moon on the installment plan as opposed to committing the country to a single program. If it is assumed that the commitment to S/AA has been made at Decision Point 1, NASA must face Decision Point 2 around 1969. Decision Point 2 involves the possible commitment to begin work on new hardware of the medium capability level. The indications provided in this report show a greater potential return (in terms of scientific mass and manhours) from the medium-level hardware within one year after its introduction than is possible with continued S/AA equipment use. However, if a decision is made to continue with S/AA hardware, a meaningful lunar program (such as Program I) is possible.

Emphasis has been placed on scientific manhour and scientific mass delivery as means of comparing alternate lunar program options. This is not because mass and

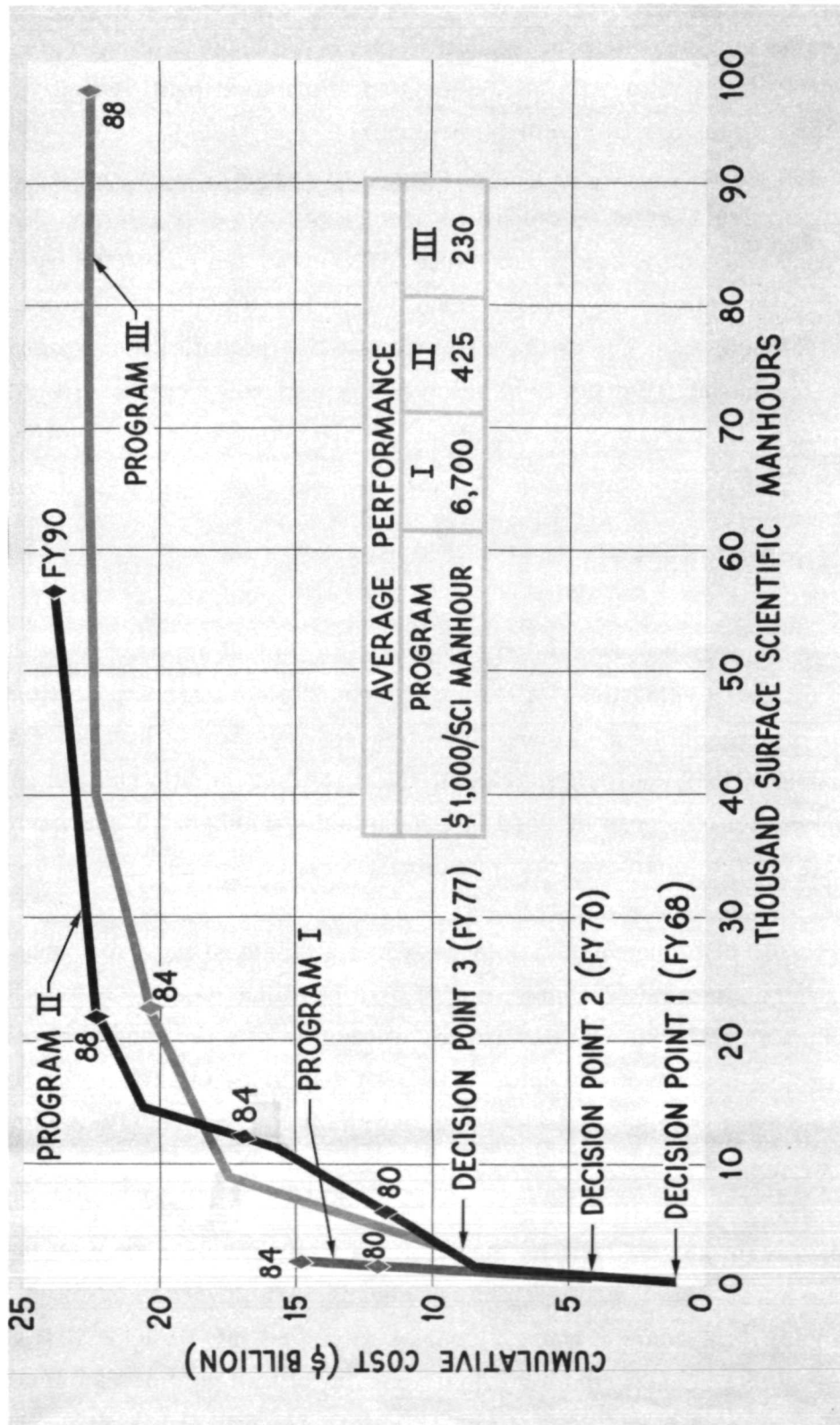

Fig. 4-17 Cumulative Cost vs. Scientific Manhour Comparison, Programs I, II, and III

manhours represent a measure of scientific merit (although at this writing, no other good measure is available). Rather, mass and manhour capability indicate the potential for performing a meaningful scientific program.

A particular program option is much like a block at the top of a ramp. The potential energy of the block can be easily measured. However, the kinetic energy of the block will depend in large measure on the interaction and inefficiencies between the block and its environment as it moves down the ramp. The potential of a program option can also be measured. But the final value of any particular option will only be made clearer as more is learned about the Moon and about this country's motivation toward lunar exploration.

4.6 SIGNIFICANT RESULTS

The analyses described in this volume represent a typical application of the MIMOSA planning tool to the evaluation of alternate approaches to lunar exploration and the formulation of a recommended plan. The results, together with those of Volume II (Candidate Lunar Exploration Programs) illustrate that the MIMOSA planning methodology is a working tool that can be used in a meaningful manner. It represents, therefore, a valuable aid to the lunar program planner.

In summary, the planning methodology provides a standard logic for lunar program generation and analysis. Mechanization of data handling, routine calculations, and data presentation are achieved through the utilization of a thoroughly checked-out computer program. The methodology has been developed in such a way that the planner is always in the analysis loop and can make his own decisions from the data presented to him.

Many of the results derived during the MIMOSA study are dependent on the original assumptions made. Such assumptions, of course, are governed by the planning environment, and represent some of the very parameters that the MIMOSA tool is intended to study. For this reason, the significant results of this volume, summarized below, should be interpreted in the light of the guidelines given in Paragraph 1.1 and the various assumptions developed throughout the volume.

Significant results arising from the development of the recommended plan are documented in the following paragraphs.

4.6.1 Scientific Program

- An integrated scientific program for lunar exploration can be postulated that reflects responsible adherence to the national lunar exploration objectives and represents a sound and reasonable approach to the attainment of those objectives. This scientific program accommodates alternate equipment options by phasing the scientific requirements to be compatible with the equipment capabilities, and permits smooth transition between phases when the increasing equipment capability is utilized in an evolutionary manner.
- The integrated scientific program emphasizes geology early (1970's) and astronomy late (1980's), and involves the following main phases:
 - (1) Visits to widely separated locales with limited mobility capability (radius of action approximately 15 km).
 - (2) Performance of long traverses (up to 1500 km) with large rovers.
 - (3) Establishment of extended lunar bases at an operating level of 6 to 12 men.
- Achievement of the total effort postulated in the MIMOSA integrated science program calls for the performance of about 100,000 scientific manhours and the delivery of about 285,000 kg of scientific mass. Geology and astronomy account for over 90 percent of the scientific mass and over 80 percent of the scientific manhours.
- Active seismology requires the delivery of substantial amounts of chemical explosives – about 20 percent of the total scientific mass delivered in performing the integrated scientific program.
- Earth return mass requirements (samples, film, etc.) exceed existing CSM capabilities by a factor of six.
- Fulfillment of scientific manhour requirements is more difficult than fulfillment of scientific mass requirements, particularly in early phases of the integrated scientific program.

4.6.2 Exploration Equipment

- A modest equipment inventory permits extensive lunar exploration.
- Recommended Saturn V uprating steps are: 111 percent (in 1971) and 188 percent (in 1981) of the basic Saturn V. Critical requirements arise from personnel delivery considerations.
- An efficient logistics delivery system is essential. The direct lunar logistics vehicle (LLV) is the most cost effective and should be introduced as soon as possible after S/AA phase of exploration. Commonality of equipment, with little compromise in performance, can be achieved at both Saturn V uprating levels by using a single stage LLV at the lower uprating and the same basic propulsion unit in a two-stage arrangement with the larger vehicle.
- A three-man lunar roving vehicle with a range of about 800 km is required by about 1975. When supplemented by the use of a trailer, this vehicle would satisfy the long traverse requirements (up to 1500 km) of the integrated scientific program.
- A six-man shelter and nuclear power supply are not required until the early 1980's, if the exploration-first/exploitation-later philosophy is maintained.
- The main requirement for a lunar flying vehicle arises from a likely need to visit places that are inaccessible to surface rovers in support of scientific observations. A one-man flyer, "pogo stick," with a range of about 7 km (introduced in 1975) should suffice.

4.6.3 Operations

- Post S/AA surface manning level requirements are 3 (1970's), 6 to 12 (1980's).
- Three-man LOR delivery techniques can be utilized through the 1970's; six-man direct delivery systems can be used efficiently in support of long-duration bases (1980's).
- The program cost penalty, associated with the use of separate launches for crew delivery and crew pickup, justifies a concerted effort towards developing a long-term CSM capable of being deactivated and stored unmanned in lunar orbit for the duration of the surface mission (up to 90 days).

4.6.4 Program and Resources

- Three key decision points regarding commitment to new capability developments will be encountered. The associated program option and the dates of these decision points are as follows:
 - (1) Introduce S/AA (approximately 1967).
 - (2) Continue with S/AA or provide extended mobile exploration potential at the medium-level capability (approximately 1969).
 - (3) Complete the medium-level program (six-man base) or provide a larger logistics and six-man delivery capability for expanded 12-man base activities (approximately 1976).
- Limited-lunar exploration can be conducted at the S/AA capability level, resulting in a potential of 2,200 surface scientific manhours at a total program cost of about \$15 billion.
- Extensive lunar exploration can be conducted with uprated systems which would yield 56,000 surface scientific manhours (medium capability level) and 97,500 surface scientific manhours (large capability level). Total program costs are about \$23 billion in each case.
- Nonrecurring costs associated with the program alternates are relatively small viz. \$0.9 billion (S/AA), \$2.8 billion (medium capability), and \$4.7 billion (large capability).
- The sensitivity of the program resource demands to the selection of the Earth-to-Moon transportation systems can be clearly understood from the distribution of total program cost by equipment categories observed in the program resource results:

Transportation systems	80 percent
Mission equipment	10 percent
Major scientific equipment	4 percent
Other (integration, minor science, etc.)	6 percent
- Extensive lunar exploration can be conducted at a funding rate of about one-third of the present manned spaceflight budget, and at a total cost approximately equal to that of the Apollo program.

Appendix A

INTEGRATED SCIENTIFIC PROGRAM OPTIONS AND MISSION SPECIFICATIONS

A detailed tabulation of the contents of the integrated scientific program is presented in this appendix. The format is one that evolved from previous mission-mode matching exercises and was found most useful for purposes of mission planning. It consists of a two-dimensional matrix comprising a list of scientific experiments by title and ID number along one coordinate and the sequence of lunar locations at which the experiments are to be performed along the other coordinate. The mass and approximate manhours per replication of each experiment are listed, and the number of replications of each experiment at each location is entered in the appropriate cell or element of the matrix. The composition of any particular mission consists of all the experiments for which replication numbers have been entered in the column under the location for that mission.

The data presented here represents the final allocation of experiments to missions resulting from the mission-mode matching operation. The actual process of scientific program formulation is an iterative operation beginning with a tentative specification of total number of replications of each experiment and allocation of experiments to appropriate locations. This is followed by one or two and sometimes three trial runs with the MIMOSA computer program needed to reach a suitable compromise between desired and permissible experiment load on each mission.

To show the contents of the program options involving three different levels of system capability, three program matrices are presented here. Scientific Program I is compatible with the option to continue the S/AA level of system capability throughout the entire exploration program. Scientific Program II is consistent with the equipment option that steps up to a medium level of capability immediately after the mission to Moltke B with a continuation at that level to the end of the exploration program. Scientific Program III is the total integrated science program and can be performed by an equipment evolution that follows the course of the second option up to the mission involving paths a and b, whereupon there is another step up in system capability permitting eventual establishment of a 12-man permanent lunar base near the end of the program.

This appendix also presents a list of experiment packages used in planning the integrated scientific program. These packages consist of groups of compatible experiments that exhibit commonality in equipment or lunar program usage. The individual experiments in each package are tabulated together with relevant mass and manhours data. All packages have been assigned the number 999999XX.

INTEGRATED SCIENTIFIC PROGRAM
(PROGRAM I)

LUNAR SURFACE PATTERN
(Scientific Program I)

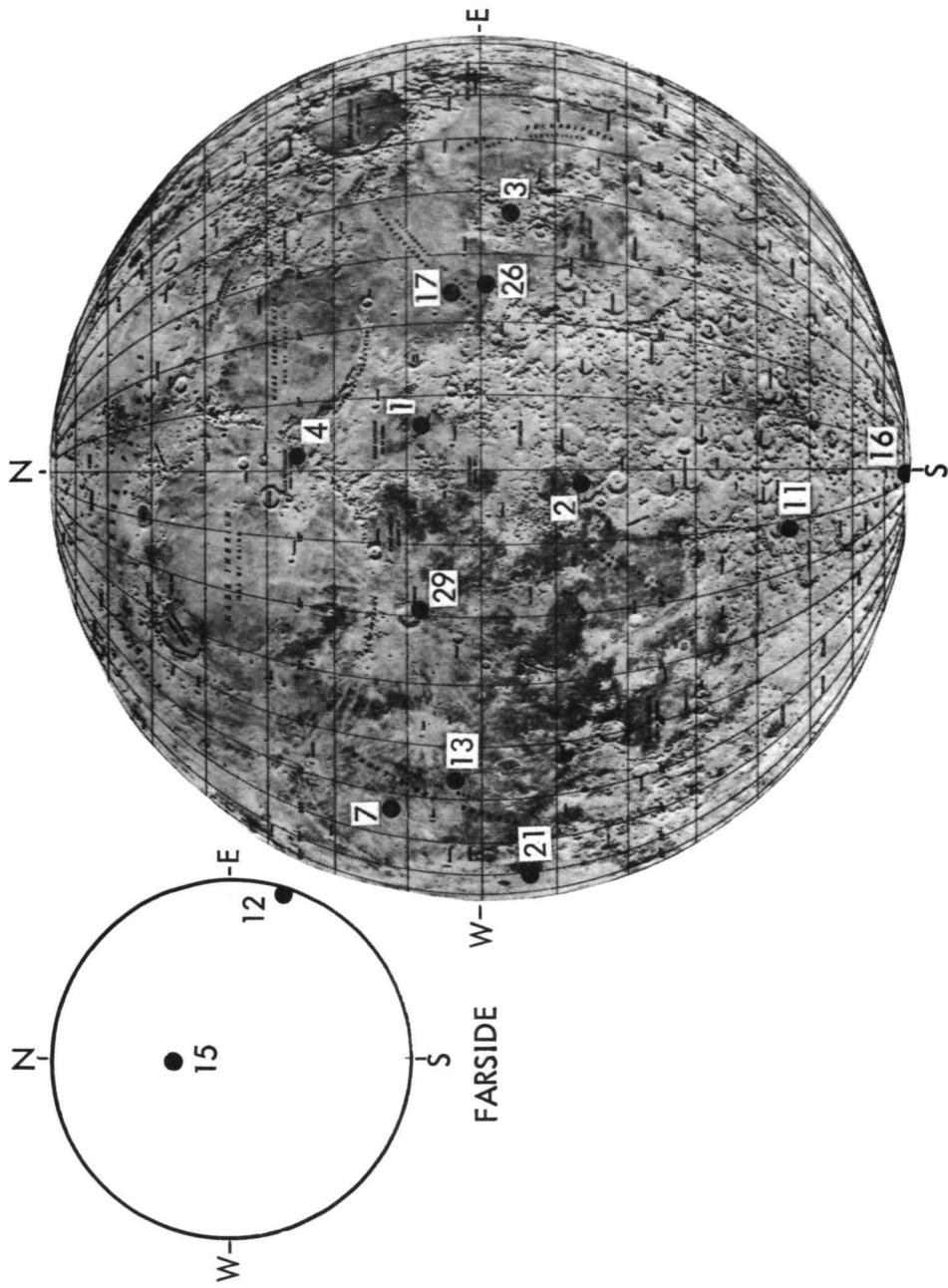

Legend:

Locales

- 1 Hyginus Rille
- 2 Alphonsus
- 3 Capella M
- 4 Hadley's Rille
- 7 Marius Hills
- 11 Tycho
- 12 Mare Orientale
- 13 Oceanus Procellarum
- 15 Center Farside
- 16 South Pole
- 17 Ranger VIII Landing Site
- 21 Grimaldi
- 26 Moltke B
- 29 Copernicus

PROGRAM I MAJOR SCIENTIFIC EQUIPMENT

No major scientific equipment is specified for Program I.

DISTRIBUTION OF EXPERIMENTS FOR PROGRAM I

ID No.	Experiment Title	Mass (kg)	Manhours per Replication	Total Number of Replications	Notes	Photographic Orbiter 2	Grinnell Local	Tycho Local	Photographic Orbiter 3	Photographic Orbiter 4	Copernicus Local	Photographic Orbiter 5	Aphana Local	Hadley's Hill Local	Mare Otomata Local	Martin Hill Local	Photographic Orbiter 6	Central Paralle Local	South Pole Local	
9999901	Early Local Experiment 1	450	43	5		1														
02	Early Local Experiment 2	210	84	5		1														
06	Astronomical Experiment, C-2-m	140	25	2	(1)		1								1					
11	Geochemical Package	74	2.8	6										1	1	1	1	1	1	1
12	Bore-Hole Logging	44	14	17	(2)															
15	Thermal Experiment	11	6	13			1	1	1	1	1	1	1	1	1	1	1	1	1	1
16	Particle Experiment 1	30	5	2	(3)															2
17	Particle Experiment 2	30	5	3	(4)															
18	Particle Experiment 3	48	5	2	(5)															
19	Particle Experiment 4	150	10	2	(3)															2
20	Particle Experiment 5	134	5	3	(4)															
21	Particle Experiment 6	166	5	2	(5)															
30	Geophysical Experiment 2	23	19	9			1	1	1	1	1	1	1	1	1	1	1	1	1	1
41	Type I Local Experiment 3	170	78	3	(10)															
42	Type II Local Experiment 3	170	74	6	(11)			1	1	1	1	1	1	1	1	1	1	1	1	1
45	Unmanned Photo Orbiter	220	0	6				1	1	1	1	1	1	1	1	1	1	1	1	1
46	Early ESS (ALSEP)	68	1	13																3
47	Advanced ESS	220	6	6																3
49	Manned Orbiter Experiment	1520	1990	3																1
9999951	100-m Drill	1190	100	3																1
02030263	Charged Dust	8	2	9																1
11010101	Selenodetic Astronomy	150	9	3																1
13030303	Surface Gravity	27	2.3	9																1
32010115	UV-Visible Spectra	15	0.1	9																1
40050324	Surface Magnetic Suscept.	2	1	5																1
40060332	Surface Resistance	4	0.4	5																1
41010405	Deep Seismic Reflection	12	4	8																1
06	Deep Seismic Refraction	11	-	8	(16)															1
10	Active Seismology, 50-km	50	10	14																1
41010414	Active Seismology, 600-km	6000	10	2	(17)															1
42020784	Remote Seismology	3	0	2																2
45030314	Gravity Survey	15	0.7	8																1
46040320	Magnetic Survey	6	0.6	8																1
66040102	Evidence of Life	57	10	2	(18)															1
76020101	Cis-lunar Wave, Central Site	50	16	3																1
80010502	Engg. Properties, Lunar Surface	2	22	2																1
80010321	Surf. and Subsurf. Electrical Prop.	35	22	2																1
80020302	RF Noise, Low Frequency	70	10	3																1
80020601	Lunar Communication, Rocket	5	1	1																1
80110101	Drill Gas Requirements	1	1	2																1
80802021	Dangerous Terrain Warning	20	3	7																1
80802021	Lunar Corner Reflectors	30	1	3																1

NOTES FOR DISTRIBUTION OF EXPERIMENTS

- (1) Site and technique evaluation experiment. May be performed anywhere on lunar surface but prefer site selected for permanent astronomical base.
- (2) One replication per 10-m hole, two per 30-m hole, ten per 300-m hole.
- (3) Schedule for period of low solar activity - 1974-76 or 1985-87.
- (4) Schedule for period of intermediate solar activity - 1971-73 or 1977-79.
- (5) Schedule for period of high solar activity - 1980-82.
- (6) Manhours given on a monthly basis for a one-man level of effort.
- (7) Manhours given on a monthly basis for a three-man level of effort.
- (8) Manhours given on a monthly basis for a six-man level of effort.
- (9) Perform at least once on every path but avoid duplication where ends of two or more paths join.
- (10) Type I locales are associated with areas of volcanic activity with possible outgassing.
- (11) Type II locales are associated with nonvolcanic areas.
- (12) Manhours given on a monthly basis for a 2.5-man level of effort.
- (13) Manhours given on a monthly basis for a five-man level of effort.
- (14) At every intermediate and advanced locale and near the midpoint of every path or at 500-km intervals on long paths, preferably near significant features.
- (15) If 30-m drill is available it may be used in place of the 10-m drill by overriding the mass of the smaller drill.
- (16) Performed with experiment 41010405 using same equipment.
- (17) Consider direct delivery of explosives or delivery from orbiters. If direct or orbital delivery is used, then the event must be followed by a photographic orbiter (99999945) to determine the exact locations of the detonation points.
- (18) Type II locales (nonvolcanic) are most likely places.

Page Intentionally Left Blank

INTEGRATED SCIENTIFIC PROGRAM
(PROGRAM II)

LUNAR SURFACE PATTERN
(Scientific Program II)

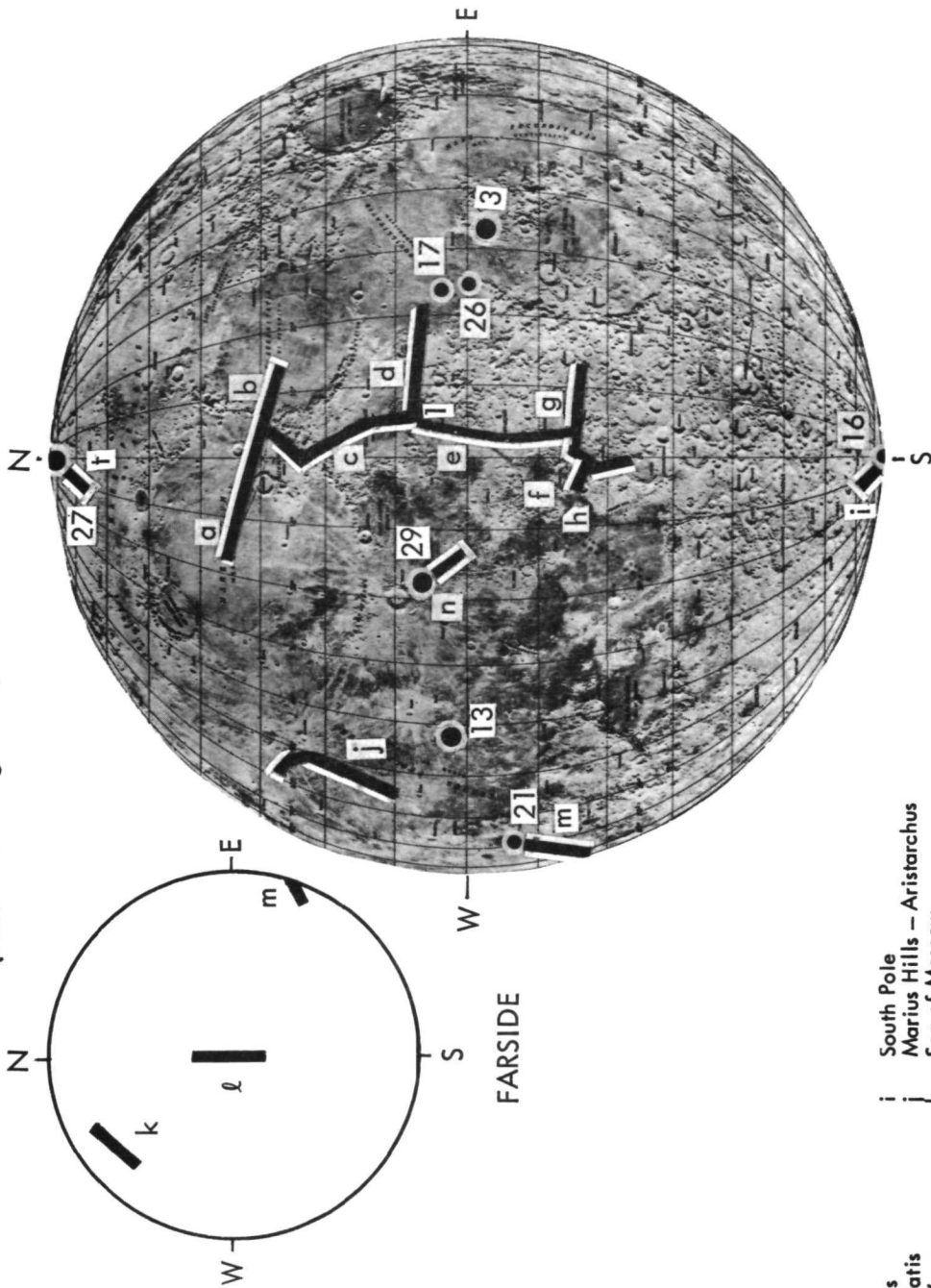

Legend:

Locales

- 1 Hyginus Rille
- 3 Capella M
- 13 Oceanus Procellarum
- 16 South Pole
- 17 Ranger VIII Landing Site
- 21 Grimaldi
- 26 Moltke B
- 27 North Pole
- 29 Copernicus

Paths

- a Mare Imbrium – Autolycus
- b Autolycus – Mare Serenitatis
- c Palus Putredinis – Mare Vaporum
- d Mare Vaporum – Mare Tranquillitatis
- e Sinus Medii
- f Ptolemaeus – Alphonsus
- g Central Highlands
- h Mare Nubium – Straight Wall

- i South Pole
- j Marius Hills – Aristarchus
- k Sea of Moscow
- l Central Farside
- m Grimaldi – Mare Orientale
- n Copernicus – Dark Halo Craters
- t North Pole

PROGRAM II MAJOR SCIENTIFIC EQUIPMENT

System ID No.	Quantity Required	Mass (kg)	Name
3213-02	5	10,928	300-m Core Drill
3222-01	1	490	Radio Telescope, Mills Cross (1-16 MHz)
3223-01	1	22,250	Radio Telescope, 15-m Parabolic Dish
3224-01	1	12,528	Radio Telescope, Mills Cross (0.3-1 MHz)
3231-01	1	1,620	X-Ray Telescope, 1-m, Grazing Incidence
3231-02	1	207	X-Ray Telescope, Wide Angle
3292-02	1	1,257	Optical Telescope, 1-m
3292-05	1	35,410	Optical Telescope, Solar
3243-01	1	23,750	Optical Telescope, 2.5-m

DISTRIBUTION OF EXPERIMENTS FOR PROGRAM II

ID No.	Experiment Title	Mass kg	Manhours per Replication	Total Number of Replications	Notes	Manned Orbiter 1	Manned Orbiter 2	Capella M	Manned Orbiter 3	Oceanus Procellarum	Molite B	Photographic Orbiter 1	Hyduna Ridge	Orinaki	Covenens and Path N	Path D	Path G and Path H	Photographic Orbiter 2	Path C, Path E and Path F	Photographic Orbiter 3	Photographic Orbiter 4	Path A and Path B	Photographic Orbiter 5	Path J	Photographic Orbiter 6	South Pole and Path M	Path K	Orinaki Base	Path L	North Pole and Path J	
0001	Early Locale Experiment 1	480	43	5		1	1	1	1	1	1	1	1	1	1	1	1	1	1	1	1	1	1	1	1	1	1	1	1		
02	Early Locale Experiment 2	210	84	5		1	1	1	1	1	1	1	1	1	1	1	1	1	1	1	1	1	1	1	1	1	1	1	1		
06	Astronomical Experiment, 0.2-m	140	25	1	(1)																										
07	Astronomical Experiment, 1-m	170	79	1																											
08	Biorhythms and Genetic Effects	450	60	30																											
12	Bore-Hole Logging	44	14	165	(2)	1	1	1	1	1	1	1	1	1	1	1	1	1	1	1	1	1	1	1	1	1	1	1	1		
15	Thermal Experiments	11	6	10		1	1	1	1	1	1	1	1	1	1	1	1	1	1	1	1	1	1	1	1	1	1	1	1		
16	Particle Experiment 1	30	5	3	(3)																										
17	Particle Experiment 2	30	5	3	(4)	1																									
18	Particle Experiment 3	48	5	3	(5)																										
19	Particle Experiment 4	150	10	3	(3)																										
20	Particle Experiment 5	134	5	3	(4)	1																									
21	Particle Experiment 6	166	5	1	(5)																										
23	Solar and Planetary Astron., 1-m	1040	240/mo.	11	(6)																										
24	X-Ray Astronomy	135	470	1																											
25	Radio Astronomy	7	0	1																											
26	Earth Observations, 0.2-m	92	55	1																											
27	Earth Observations, 1-m	210	240/mo.	11	(6)																										
28	Stellar Astronomy, 1-m	270	720	11	(7)																										
29	Stellar Astronomy, 2.3-m	2016	1440	11	(8)																										
30	Geophysical Experiment 2	23	19	5		1	1	1	1	1	1	1	1	1	1	1	1	1	1	1	1	1	1	1	1	1	1	1	1		
32	5-km Path Package	21	1	1500																											
33	10-km Path Package	86	1	750																											
34	100-km Path Package	59	22	82	(9)																										
35	200-km Path Package	75	41	45	(9)																										
36	500-km Path Package	61	27	25	(9)																										
38	Type I Locale Experiment 2	229	36	1	(10)	1																									
40	Type II Locale Experiment 2	223	30	3	(11)																										
41	Type I Locale Experiment 3	170	78	2	(10)	1																									
42	Type II Locale Experiment 3	170	74	3	(11)																										
43	Temporary Base Experiments	93	600/mo.	2	(12)																										
44	Permanent Base Experiments	2400	1200/mo.	10	(13)																										
45	Unmanned Photo Orbiter	220	0	6																											
16	Early ESS (ALSEP)	68	1	6		1	1	1	1	1	1	1	1	1	1	1	1	1	1	1	1	1	1	1	1	1	1	1	1		
47	Advanced ESS	220	6	3																											
8-09049	Manned Orbiter Experiments	1820	1990	3		1	1	1	1	1	1	1	1	1	1	1	1	1	1	1	1	1	1	1	1	1	1	1	1	1	
02-00053	Charged Dust	8	2	3																											
11-10101	Selenodetic Astronomy	150	9	24	(14)																										
12-10202	Selenodetic Survey	290	7	31	(14)																										
2-010412	30-m Drill	110	26	29	(14)																										
31-03007	10-m Drill	44	5	60	(15)																										
31-03008	300-m Drill	-	383	8																											
40-03024	Surface Magnetic Suscept.	2	1	9		1	1	1	1	1	1	1	1	1	1	1	1	1	1	1	1	1	1	1	1	1	1	1	1	1	
1-06032	Surface Resistance	4	0.4	9		1	1	1	1	1	1	1	1	1	1	1	1	1	1	1	1	1	1	1	1	1	1	1	1	1	

DISTRIBUTION OF EXPERIMENTS FOR PROGRAM II (Cont.)

ID No.	Experiment Title	Manhours Per Replication	Total Number of Replications	Notes	Manned Orbiter 1	Manned Orbiter 2	Manned Orbiter 3	Manned Orbiter 4	Manned Orbiter 5	Manned Orbiter 6	Manned Orbiter 7	Manned Orbiter 8	Manned Orbiter 9	Manned Orbiter 10	Manned Orbiter 11	Manned Orbiter 12	Manned Orbiter 13	Manned Orbiter 14	Manned Orbiter 15	Manned Orbiter 16	Manned Orbiter 17	Manned Orbiter 18	Manned Orbiter 19	Manned Orbiter 20	Manned Orbiter 21	Manned Orbiter 22	Manned Orbiter 23	Manned Orbiter 24	Manned Orbiter 25	Manned Orbiter 26	Manned Orbiter 27	Manned Orbiter 28	Manned Orbiter 29	Manned Orbiter 30		
40080454	Microvoid Detection	4	11																																	
41010405	Deep Seismic Reflection	12	4																																	
06	Deep Seismic Refraction	11	-	(16)																																
10	Active Seismology, 50-km	80	10	16																																
11	Active Seismology, 100-km	1300	10	4																																
13	Active Seismology, 200-km	2500	10	14 (17)																																
14	Active Seismology, 600-km	6000	10	2 (17)																																
41050341	Electromagnetic Pulse	4	-	11																																
44070451	Surface Temperature	1	-	11																																
68040102	Evidence of Life	57	10	6 (18)																																
73020622	X-Ray Astronomy Spectrum	100	6	1 (1)																																
24	X-Ray Astronomy Intergalactic	25	436	1																																
73010101	Radio Astronomy, Non-directional	7	10	1 (1)																																
02	Radio Astronomy, Directional	510	51	1																																
76020102	Lunar Wave Propagation	30	38	3																																
78020101	Cislunar Wave, Central Site	50	16	1 (19)																																
02	Cislunar Wave, East or West Site	50	16	1 (20)																																
03	Cislunar Wave, North or South Site	50	16	1 (21)																																
80010202	E. Properties, Lunar Surface	2	22	2																																
03	E. Properties, Lunar Subsurface	6	10	3																																
21	Surf. and Subsurf. Electrical Prop.	35	22	1																																
22	Lunar Strata E.M. Properties	3	14	2																																
80020101	Dust Environment Test	2	4	1																																
80020202	RF Noise, Low Frequency	70	10	2																																
03	RF Noise, High Frequency	6	12	2																																
80020501	Lunar Contamination, Rocket	5	1	1																																
02	Leakage from Shellers	5	1	3																																
80110101	Drill Gas Requirements	1	1	1																																
80110401	Eval. of Sampling Techniques	20	8	1																																
80120301	Explosive Energy Coupling	10	16	1																																
80130101	Soil Biocorrosion	15	2	1																																
80180101	Optical Astronomy Tests	120	35	1 (1)																																
80320201	Forward Scatter	10	38	2																																
80340101	Dust Removal Techniques	10	2	1																																
80340301	Failure Effects, Materials	5	8	1 (22)																																
80340401	Exposure Effects, Mechanisms	20	8	1 (22)																																
03	Exposure Effects, Electronics	10	8	1 (22)																																
80350201	Repair Techniques	10	13	1																																
80360201	Dangerous Terrain Warning	20	3	4																																
80430301	Particle Adhesion Effects	400	46	1																																
90010101	High Density Electron Beams	15	35	1																																
90040101	Lifetime of Atomic Species	100	118	1																																
90050101	Lorentz Plasma Studies	10	6	1																																
90070201	Laser Corner Reflectors	30	1	1 (23)																																

NOTES FOR DISTRIBUTION OF EXPERIMENTS

- (1) Site and technique evaluation experiment. May be performed anywhere on lunar surface but prefer site selected for permanent astronomical base.
- (2) One replication per 10-m hole, two per 30-m hole, ten per 300-m hole.
- (3) Schedule for period of low solar activity - 1974-76 or 1985-87.
- (4) Schedule for period of intermediate solar activity - 1971-73 or 1977-79.
- (5) Schedule for period of high solar activity - 1980-82.
- (6) Manhours given on a monthly basis for a one-man level of effort.
- (7) Manhours given on a monthly basis for a three-man level of effort.
- (8) Manhours given on a monthly basis for a six-man level of effort.
- (9) Perform at least once on every path but avoid duplication where ends of two or more paths join.
- (10) Type I locales are associated with areas of volcanic activity with possible outgassing.
- (11) Type II locales are associated with nonvolcanic areas.
- (12) Manhours given on a monthly basis for a 2.5-man level of effort.
- (13) Manhours given on a monthly basis for a five-man level of effort.
- (14) At every intermediate and advanced locale and near the midpoint of every path or at 500-km intervals on long paths, preferably near significant features.
- (15) If 30-m drill is available it may be used in place of the 10-m drill by overriding the mass of the smaller drill.
- (16) Performed with experiment 41010405 using same equipment.
- (17) Consider direct delivery of explosives or delivery from orbiters. If direct or orbital delivery is used, then the event must be followed by a photographic orbiter (99999945) to determine the exact locations of the detonation points.
- (18) Type II locales (nonvolcanic) are most likely places.
- (19) Coherent radar transponder; located at or near center of lunar nearside.
- (20) Coherent radar transponder; located near east or west limb of lunar nearside.
- (21) Coherent radar transponder; located as far north or south as feasible on the lunar nearside.
- (22) If feasible, should be set up at bases with a staytime of at least 6 mo or at locales to be revisited by a subsequent mission.
- (23) Should be set up at same locales as experiments 7802101, 7802102, and 78020103.

INTEGRATED SCIENTIFIC PROGRAM
(PROGRAM III)

LUNAR SURFACE PATTERN
(Scientific Program III)

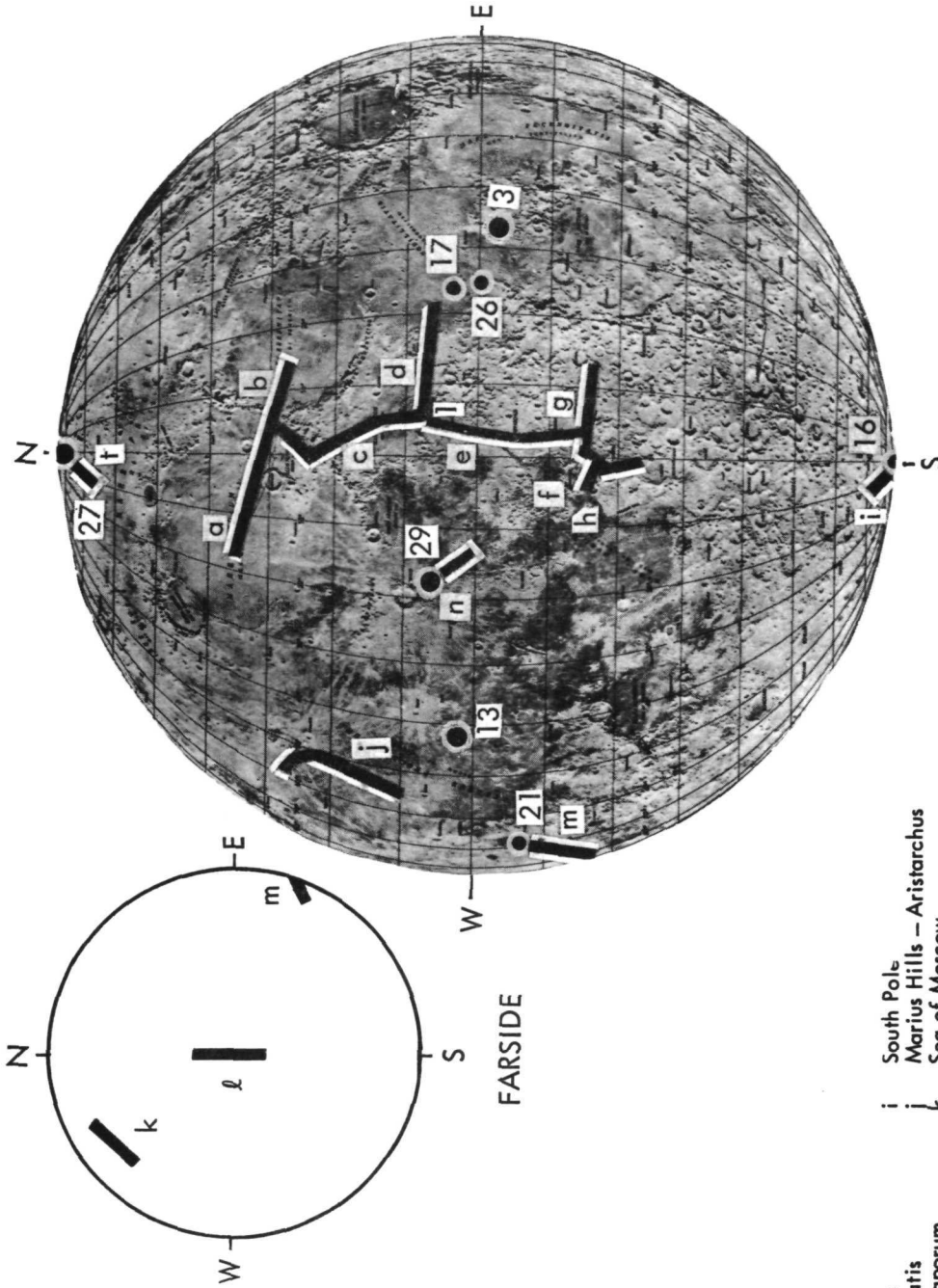

Legend:

Locales

- 1 Hyginus Rille
- 3 Capella M
- 13 Oceanus Procellarum
- 16 South Pole
- 17 Ranger VIII Landing Site
- 21 Grimaldi
- 26 Moltke B
- 27 North Pole
- 29 Copernicus

Paths

- a Mare Imbrium – Autolyucus
- b Autolyucus – Mare Serenitatis
- c Palus Putredinis – Mare Vaporum
- d Mare Vaporum – Mare Tranquillitatis
- e Sinus Medii
- f Ptolemaeus – Alphonsus
- g Central Highlands
- h Mare Nubium – Straight Wall

- i South Pole
- j Marius Hills – Aristarchus
- k Sea of Moscow
- l Central Farside
- m Grimaldi – Mare Orientale
- n Copernicus – Dark Halo Craters
- t North Pole

PROGRAM III MAJOR SCIENTIFIC EQUIPMENT

System ID No.	Quantity Required	Mass (kg)	Name
3213-02	8	10,428	300-m Core Drill
3222-01	1	490	Radio Telescope, Mills Cross (1-16 MHz)
3223-01	1	22,250	Radio Telescope, 15-m Parabolic Dish
3224-01	1	15,528	Radio Telescope, Mills Cross (0.3-1MHz)
3231-01	1	1,620	X-Ray Telescope, 1-m, Grazing Incidence
3231-02	1	207	X-Ray Telescope, Wide Angle
3242-02	3	1,257	Optical Telescope, 1-m
3242-05	1	35,410	Optical Telescope, Solar
3243-01	1	23,750	Optical Telescope, 2.5-m

DISTRIBUTION OF EXPERIMENTS FOR PROGRAM III

ID No.	Experiment Title	Mass kg	Manhours per Replication	Total Number of Replications	Notes	Manned Orbiter 1	Manned Orbiter 2	Manned Orbiter 3	Capella M	Manned Orbiter 4	Capella M	Manned Orbiter 5	Oceanus Procellarum	Photographic Orbiter 1	Mobile B	Grimaldi	Copernicus and Path N	Path D	Path G and Path H	Photographic Orbiter 2	Path C, Path E, and Path F	Photographic Orbiter 3	Photographic Orbiter 4	Path A and Path B	Photographic Orbiter 5	Path J	Photographic Orbiter 6	Orimaldi and Path M	South Pole and Path I	Path K	Orimaldi Base	Path L	North Pole and Path J				
9999901	Early Local Experiment 1	450	43	5		1	1	1	1	1	1	1	1	1	1	1	1	1	1	1	1	1	1	1	1	1	1	1	1	1	1	1					
02	Early Local Experiment 2	210	84	5		1	1	1	1	1	1	1	1	1	1	1	1	1	1	1	1	1	1	1	1	1	1	1	1	1	1	1	1				
06	Astronomical Experiment, 0.2-m	140	25	1 (1)																																	
07	Astronomical Experiment, 1-m	170	79	1																																	
08	Biohybrids and Genetic Effects	450	60	47																																	
12	Bore-Hole Logging	44	14	201 (2)		1	1	1	1	1	1	1	1	1	1	1	1	1	1	1	1	1	1	1	1	1	1	1	1	1	1	1	1				
15	Thermal Experiments	11	6	11		1	1	1	1	1	1	1	1	1	1	1	1	1	1	1	1	1	1	1	1	1	1	1	1	1	1	1	1	1			
16	Particle Experiment 1	30	5	3 (3)																																	
17	Particle Experiment 2	30	5	3 (4)																																	
18	Particle Experiment 3	48	5	3 (5)																																	
19	Particle Experiment 4	150	10	3 (3)																																	
20	Particle Experiment 5	134	5	3 (4)																																	
21	Particle Experiment 6	166	5	1 (5)																																	
23	Solar and Planetary Astron., 1-m	1040	240/mo.	31 (6)																																	
24	X-Ray Astronomy	135	470	1																																	
25	Radio Astronomy	7	0	1																																	
26	Earth Observations, 0.2-m	92	55	1																																	
27	Earth Observations, 1-m	210	240/mo.	11 (6)																																	
28	Stellar Astronomy, 1-m	210	780	11 (7)																																	
29	Stellar Astronomy, 2.5-m	2016	1440	23 (8)																																	
30	Geophysical Experiment 2	23	19	6																																	
32	5-km Path Package	21	1	1700																																	
33	10-km Path Package	86	1	850																																	
34	100-km Path Package	59	23	94 (9)																																	
35	200-km Path Package	75	41	52 (9)																																	
36	500-km Path Package	61	27	29 (9)																																	
38	Type I Local Experiment 2	229	36	1 (10)																																	
40	Type II Local Experiment 2	223	30	3 (11)																																	
41	Type I Local Experiment 3	170	78	2 (10)																																	
42	Type II Local Experiment 3	170	74	3 (11)																																	
43	Temporary Base Experiments	93	600/mo.	17 (12)																																	
44	Permanent Base Experiments	2400	1200/mo.	14 (13)																																	
45	Unmanned Photo Orbiter	220	0	6																																	
46	Early ESS (ALBEP)	68	1	6																																	
47	Advanced ESS	220	6	3																																	
9999949	Manned Orbiter Experiments	1520	1990	3		1	1	1	1	1	1	1	1	1	1	1	1	1	1	1	1	1	1	1	1	1	1	1	1	1	1	1	1	1	1		
02030283	Charged Dust	8	2	3																																	
11010101	Heliodetic Astronomy	150	9	28 (14)																																	
12010202	Heliodetic Survey	290	7	28 (14)																																	
21010412	30-m Drill	110	26	33 (14)																																	
21020307	10-m Drill	44	5	68 (15)																																	
21020308	300-m Drill	--	383	12																																	
140050324	Surface Magnetic Suscept.	2	1	11																																	
40060332	Surface Resistance	4	0.4	11																																	

DISTRIBUTION OF EXPERIMENTS FOR PROGRAM III (Cont.)

ID No.	Experiment Title	Manhrs	Manhours for Replication	Total Number of Replications	Notes	Manndr Orbiter 1	Manndr VIII Site	Manndr Orbiter 2	Capella M	Manndr Orbiter 3	Oceanic Proccgram	Photographic Orbiter 1	Myrina Hills	Graindri	Copernicus and Path N	Path D	Path G and Path H	Photographic Orbiters	Path C, Path E, and Path F	Photographic Orbiter 3	Photographic Orbiter 4	Path A and Path B	Photographic Orbiter 5	Path J	Photographic Orbiter 6	South Pole and Path M	Path K	Graindri Base	Path L	North Pole and Path J
6000454	Meteoroid Detection	4	-	13																										
41010405	Deep Seismic Reflection	12	4	3						1	1	1	1	1	1	1	1	1	1	1	1	1	1	1	1	1	1	1	1	
06	Deep Seismic Reflection	11	-	3	(10)					1	1	1	1	1	1	1	1	1	1	1	1	1	1	1	1	1	1	1	1	
10	Active Seismology, 50-km	60	10	24						4	4	4	4	4	4	4	4	4	4	4	4	4	4	4	4	4	4	4	4	
11	Active Seismology, 100-km	1300	10	4																										
13	Active Seismology, 200-km	3500	10	14	(17)																									
14	Active Seismology, 400-km	6000	10	2	(17)																									
41050341	Electromagnetic Pulse	4	-	13																										
44070431	Surface Temperature	5	-	13																										
64040102	Evidence of Life	57	10	6	(16)																									
73030422	X-Ray Astronomy Spectrum	100	6	1	(1)																									
24	X-Ray Astronomy Interplanetary	25	436	1																										
75010101	Radio Astronomy, Nondirectional	7	10	1	(1)																									
02	Radio Astronomy, Directional	510	51	1																										
76020102	Lunar Wave Propagation	30	38	3																										
76020101	Chalmar Wave, Central Site	50	16	1	(19)																									
02	Chalmar Wave, East or West Site	50	16	1	(20)																									
03	Chalmar Wave, North or South Site	50	16	1	(21)																									
60010302	Engg. Properties, Lunar Surface	2	23	2																										
03	Engg. Properties, Lunar Subsur- face	6	10	3																										
21	Surf. and Subsurf. Electrical Prop.	35	22	1																										
22	Lunar Strata EM Properties	3	14	2																										
60020101	Dust Environment Test	2	4	1																										
60020302	RF Noise, Low Frequency	70	10	2																										
03	RF Noise, High Frequency	6	12	2																										
60020501	Lunar Contamination, Rocket	5	1	1																										
03	Leakage from Shelters	5	1	3																										
60110101	Drill Gas Requirements	1	1	1																										
60110401	Eval. of Sampling Techniques	20	8	1																										
60120301	Explosive Energy Coupling	10	18	1																										
60130101	Soil Biocorrosion	15	2	1																										
60160101	Optical Astronomy Tests	120	35	1	(1)																									
60320201	Forward Scattering	10	38	2																										
60340101	Dust Removal Techniques	10	2	1																										
60340301	Exposure Effects, Materials	5	8	1	(22)																									
60340401	Exposure Effects, Mechanisms	20	6	1	(22)																									
03	Exposure Effects, Electronics	10	4	1	(22)																									
60350201	Repair Techniques	10	13	1																										
60350201	Dangerous Terrain Warning	20	3	4																										
60430301	Particle Adhesion Effects	400	44	1																										
60010101	High-Intensity Electron Beams	15	35	1																										
60040101	Lifetime of Atomic Species	100	118	1																										
60050101	Lorentz Plasma Studies	10	6	1																										
60060201	Laser Corner Reflectors	30	1	1	(23)																									

NOTES FOR DISTRIBUTION OF EXPERIMENTS

- (1) Site and technique evaluation experiment. May be performed anywhere on lunar surface but prefer site selected for permanent astronomical base.
- (2) One replication per 10-m hole, two per 30-m hole, ten per 300-m hole.
- (3) Schedule for period of low solar activity - 1974-76 or 1985-87.
- (4) Schedule for period of intermediate solar activity - 1971-73 or 1977-79.
- (5) Schedule for period of high solar activity - 1980-82.
- (6) Manhours given on a monthly basis for a one-man level of effort.
- (7) Manhours given on a monthly basis for a three-man level of effort.
- (8) Manhours given on a monthly basis for a six-man level of effort.
- (9) Perform at least once on every path but avoid duplication where ends of two or more paths join.
- (10) Type I locales are associated with areas of volcanic activity with possible outgassing.
- (11) Type II locales are associated with nonvolcanic areas.
- (12) Manhours given on a monthly basis for a 2.5-man level of effort.
- (13) Manhours given on a monthly basis for a five-man level of effort.
- (14) At every intermediate and advanced locale and near the midpoint of every path or at 500-km intervals on long paths, preferably near significant features.
- (15) If 30-m drill is available it may be used in place of the 10-m drill by overriding the mass of the smaller drill.
- (16) Performed with experiment 41010405 using same equipment.
- (17) Consider direct delivery of explosives or delivery from orbiters. If direct or orbital delivery is used, then the event must be followed by a photographic orbiter (99999945) to determine the exact locations of the detonation points.
- (18) Type II locales (nonvolcanic) are most likely places.
- (19) Coherent radar transponder; located at or near center of lunar nearside.
- (20) Coherent radar transponder; located near east or west limb of lunar nearside.
- (21) Coherent radar transponder; located as far north or south as feasible on the lunar nearside.
- (22) If feasible, should be set up at bases with a staytime of at least 6 mo or at locales to be revisited by a subsequent mission.
- (23) Should be set up at same locales as experiments 7802101, 7802102, and 78020103.

SUMMARY OF EXPERIMENT PACKAGES

Package		Experiment			
ID No.	Name	ID No.	Name	Manhours per Replication	Mass (kg)
99999901	Early Locale Experiment 1	11010101	Selenodetic Astronomy	10	150
		12010202	Selenodetic Survey	6	290
		21020307	Shallow Drilling	10(a)	44
		24030413	Paleomagnetism	1	1
		40010202	Seismic Velocity	1	11
		40050326	Magnetic Susceptibility	2(a)	2
		40050338	Dielectric Constant	2(a)	4
		40130373	Radioactivity	2(a)	2
		40140357	Sample Collection	10(a)	6
		Package Total			
99999902	Early Locale Experiment 2	13030303	Absolute Gravity	2	27
		21010203	Fine Structure Definition	10	38
		21010204	Geologic Mapping	16	28
		21040205	Surface Photogeology	5(a)	33
		32010107	Mineral X-Ray	9(a)	9
		32010101	Neutron Activation	9(a)	16
		32010113	Gamma Scattering	5(a)	2
		32010114	In Situ X-Ray	3(a)	9
		32010115	Visible Spectra	12(a)	15
		33010101	Gamma Spectrometry	2(a)	30
		40090356	Surface Hardness	-	2
		40130371	Alpha Mass Spectrometry	-	12
		45030314	Gravity Survey	10(a)	30
		Package Total			
99999903	Intermediate Locale Experiment 1	11010101	Selenodetic Astronomy	10	150
		12010202	Selenodetic Survey	6	290
		13030303	Surface Gravity	2	27
		21010203	Fine Structure Definition	10	38
		21010204	Geologic Mapping	48(a)	28
		21020307	Shallow Drilling	10(a)	44
		24030413	Paleomagnetism	1	1
		40050326	Magnetic Susceptibility	2(a)	2
		40050338	Dielectric Constant	2(a)	4
		40010202	Seismic Velocity	3(a)	11
		Package Total			

Footnoted letter notations appear at end of the table.

PACKAGES (Cont.)

Package		Experiment			
ID No.	Name	ID No.	Name	Manhours per Replication	Mass (kg)
99999904	Intermediate Locale Experiment 2	21040205	Surface Photogeology	5	33
		32010107	Mineralogical X-Ray	21 ^(a)	9
		32010108	Mineralogy and Petrography	25 ^(a)	7
		32010101	Neutron Activation	12 ^(a)	16
		40060330	Self-Potential	8 ^(a)	2
		44070444	Subsurface Temperature	1	1
		Package Total			72
99999905	Intermediate Locale Experiment 3	32010113	Gamma Scattering	20 ^(a)	2
		32010114	In Situ X-Ray	10 ^(a)	9
		32010115	UV and Visible Spectra	12 ^(a)	15
		33010101	Gamma Spectrometry	20 ^(a)	32
		40090356	Surface Hardness	-	2
		40120378	Gamma Spectrometry	1	6
		40130371	Alpha Mass Spectrometry	1	12
		40130373	Radioactivity	2	2
		41020411	Seismic Array	4	11
		45030314	Gravity Survey	10 ^(a)	30
Package Total			80	107 ^(b)	
99999906	Astronomical Experiment, 8-in. Telescope	55220101	Outer Corona Spectra	-	110
		55220201	Flare UV Spectra	-	30
Package Total			25 ^(a)	140	
99999907	Astronomical Experiment, 1-m Telescope	55220301	Granulation Fine Structure	-	100
		55220401	Sunspot Formation	-	100
		55220601	Flare Ejection	-	10
		55230101	UV Low Dispersion	-	900
		72010308	Photographic Observations	-	30
		72010309	Photographic Photometry	-	50
		72010310	Photoelectric Photometry	-	15
		72010311	Spectroscopy	-	85
		72010312	High-Dispersion Spectroscopy	-	300
		72010313	Spectroscopy Scan	-	75
Package Total			79 ^(c)	1,665	
99999908	Biorhythms and Genetic Effects	67010201	Plant Biorhythms	-	26
		67010301	Plant General Effects	-	260
		67020202	Animal Biorhythms	-	100
		67030303	Microorganism Genetic Effects	-	100
Package Total			60 ^(c)	486	

Footnoted letter notations appear at end of the table.

PACKAGES (Cont.)

Package		Experiment			
ID No.	Name	ID No.	Name	Manhours per Replication	Mass (kg)
99999909	Early ESS	Package Total		22	150
99999910	Later ESS	Package Total		22	150
99999911	Geochemical Package	32010101	Neutron Activation	2.2	16
		32010113	Gamma Scattering	0.1	2
		32010114	In Situ X-Ray	0.1	9
		32010115	UV and Visible Spectra	0.1	15
		33010101	Gamma Spectrometry	0.2	32
		Package Total		2.7	74
99999912	Bore-Hole Logging Package	21040411	Visual Logging	2	2.0
		40010202	Seismic Velocity	3	11
		40050326	Magnetic Susceptibility	2	2.0
		40050338	Dielectric Constant	0.2	4.0
		40060328	Self-Potential	2	2.5
		40060334	Subsurface Resistivity	0.2	2.0
		44070343	Subsurface Temperature	0.2	0.6
		34010402	Mass Spectrometer	5	20
Package Total		15	44		
99999913	100-km Package (Path)	41010405	Deep Seismic Reflection	2	12
		41010406	Deep Seismic Refraction	-	11
		21010204	Geologic Mapping	8.0	28
		Package Total		10	51
99999914	Geophysical Package - 1	21020307	Shallow Drilling	19 ^(a)	44
		40010202	Seismic Velocity	2 ^(a)	11
		40010303	Reflection Profile	2 ^(a)	11
		40010304	Refraction Profile	6 ^(a)	11
		40050324	Magnetic Susceptibility	2	2
		40060330	Electromagnetic Survey	2	4
		40060332	Surface Resistivity	1	4
		40060334	Subsurface Resistivity	2	2
		41050341	E-M Pulse	-	4
		Package Total		36	93
99999915	Thermal Package	44070047	Surface Diffusivity	1	6
		44070050	Surface Emissivity	2	1
		44070148	Subsurface Diffusivity	1	2
		44070343	Subsurface Temperature	1	1
		44070449	Subsurface Diffusivity	1	1
		Package Total		6	11

Footnoted letter notations appear at end of the table.

PACKAGES (Cont.)

Package		Experiment			
ID No.	Name	ID No.	Name	Manhours per Replication	Mass (kg)
99999916	Particle Experiment - 1	52020101	Solar Charged Particle, Low Energy	(d)	5
		52020201	Solar Charged Particle, High Energy	(d)	20
		52020401	Nuclear Radiation Environment	(d)	5
		Package Total		5	30
99999917	Particle Experiment - 2	52020102	Solar Charged Particle, Low Energy	(d)	5
		52020202	Solar Charged Particle, High Energy	(d)	25
		Package Total		5	30
99999918	Particle Experiment - 3	52020103	Solar Charged Particle, Low Energy	(d)	5
		52020203	Solar Charged Particle, High Energy	(d)	43
		Package Total		5	48
99999919	Particle Experiment - 4	52020402	Solar High Energy Electrons	(d)	20
		52030101	Galactic Nuclei	(d)	110
		52030201	Galactic Electrons	(d)	110
		53010101	Solar Wind	(d)	5
		53050101	Solar Geomagnetic Field	(d)	5
		Package Total		10	150 ^(b)
99999920	Particle Experiment - 5	52030102	Galactic Nuclei	(d)	110
		52030202	Galactic Electrons	(d)	110
		53050103	Solar Geomagnetic Field	(d)	4.1
		Package Total		5	134 ^(b)
99999921	Particle Experiment - 6	52020403	Solar High Energy Electrons	(d)	18
		52030103	Galactic Nuclei	(d)	110
		52030203	Galactic Electrons	(d)	110
		Package Total		5	166 ^(b)
99999922	Solar Astronomy, 8-in. Manned	55220101	Outer Corona Spectra	-	115
		55220201	Flare UV Spectra I	-	130
		Package Total		15 ^(c)	145

Footnoted letter notations appear at end of the table.

PACKAGES (Cont.)

Package		Experiment			
ID No.	Name	ID No.	Name	Manhours per Replication	Mass (kg)
99999923	Solar Astronomy, 40-in. Manned	55220301	Granulation Fine Structure	-	90
		55220401	Sunspot Formation	-	5
		55220601	Flare Ejecta	-	10
		55230101	UV Low Dispersion	-	905
		55230102	UV High Dispersion	-	9
		55230201	Flare UV Spectra II	-	5
		Package Total			240 (per month)
99999924	X-Ray Astronomy	73020622	X-Ray Spectral Characteristics	6	105
		73020623	X-Ray Angular Positions	26	30
		73020624	Distribution of Interstellar Material	436	-
		Package Total			468
99999925	Radio Astronomy, Automatic	75010101	Non-Directional Radio Astronomy	(d)	7
		75010102	Directional Radio Astronomy	(d)	-
		75030101	Submillimeter Radio Astronomy	(d)	-
		Package Total			0
99999926	Earth Observations, 6-in.	47010101	Heat Balance	-	78
		47020202	Albedo and Reflectance	-	78
		47030303	Air Glow	-	78
		47040404	UV Scattering	-	78
		47050505	IR Scanning	-	78
		49010101	Ocean Heat Balance	-	69
		49020101	Multiband Photo	-	73
		Package Total			55 ^(c)
99999927	Earth Observations, 40-in.	47050512	Large-Scale Phenomona	-	12
		47060606	Atmospheric Refraction	-	11
		47070707	Solar Eclipse	-	7
		49010102	Ocean Heat Balance	-	69
		49020102	Multiband Photo	-	20
		49030101	Ocean Height Measurement	-	110
		Package Total			240 (per month)
99999928	Stellar Astronomy, 40-in.	72010308	Photographic Observations (40)	-	-
		72010309	Photographic Photometry (40)	-	-
		72010310	Photoelectric Photometry (40)	-	15

Footnoted letter notations appear at end of the table.

PACKAGES (Cont.)

Package		Experiment			
ID No.	Name	ID No.	Name	Manhours per Replication	Mass (kg)
99999928	Stellar Astronomy, 40-in. (Cont.)	72010311	Spectroscopy (40)	-	30
		72010312	High-Dispersion Spectroscopy (40)	-	200
		72010313	Spectral Scanning	-	25
		Package Total			720 (per month)
99999929	Stellar Astronomy, 100-in.	72010414	High-Resolution Photography (100)	-	-
		72010415	High-Dispersion Spectroscopy (100)	-	2,000
		72010416	High-Energy Stars (100)	-	-
		72010417	Stellar Outer Envelope (100)	-	-
		72010418	Planet-Like Companions (100)	-	-
		72010419	Photoelectric Magnitude and Color (100)	-	16
		Package Total			1,440 (per month)
99999930	Geophysical Package 2	40090055	Surface Hardness	0.3	2.0
		40110277	Neutron Spectra	0.4	5
		40120479	Gamma Spectrometry	2	6
		41040281	Magnetism - Telluric	6	5
		41050322	Magnetism - Remnant	4	2
		41050423	Magnetism - Remnant	6	2
		44070742	Near-Surface Temperature	0.2	1
		Package Total			19
99999931	Point Package	21010203	Fine-Structure Definition	10 ^(a)	38.0
		21010204	Geologic Mapping	16 ^(a)	28.0
		24030310	Section Measurements	6 ^(a)	28.0
		21040411	Visual Logging	4 ^(a)	1.7
		40140357	Surface Sampling	20 ^(a)	6.0
		45030314	Gravity Survey	10 ^(a)	30.0
		Package Total			66
99999932	5-km Path Package	45030314	Gravity Survey	0.2	15.0
		45030415	Gravity Survey	0.4	15.0
		46040320	Magnetic Survey	0.1	6.0
		Package Total			0.7
99999933	10-km Path Package	40070383	Spectral Reflectance	-	12.0
		32010111	Neutron Activation	0.2	16.0

Footnoted letter notations appear at end of the table.

PACKAGES (Cont.)

Package		Experiment			
ID No.	Name	ID No.	Name	Manhours per Replication	Mass (kg)
99999933	10-km Path Package (Cont.)	32010113	Gamma Scattering	0.2	2.0
		32010114	In Situ X-Ray	0.1	9.0
		32010115	UV and Visible Spectra	0.1	15.0
		33010101	Gamma-Ray Spectrometry	0.2	32.0
		Package Total			0.8
99999934	100-km Path Package	21010309	Surface Sampling	10.0 ^(a)	4.1
		40060330	Electrical Surveying	1.5	4.3
		40060332	Surface Resistivity	0.4	4.0
		41010405	Deep Seismic Reflection	2.1	12.0
		41010406	Deep Seismic Refraction	-	11.0
		21010204	Geologic Mapping	8.0	28.0
		Package Total			22.0
99999935	200-km Path Package	21010204	Geologic Mapping	6	28
		21010203	Fine-Structure Definition	10	38.0
		21040205	Surface Photogeology	5.0	33.0
		24020210	Section Measurement	2.0	28.0
		32010301	Volatile Determination and Collection	4.3	7.0
		44070047	Surface Temperature Diffusivity	2	6.8
		44070050	Surface Emissivity	4	1.0
		44070148	Subsurface Diffusivity	2	2.6
		44070343	Subsurface Temperature	0.4	0.6
		44070449	Temperature Diffusivity	0.4	0.5
		Package Total			41
99999936	500-km Path Package	13030303	Absolute Gravity	2.2	27.0
		40010202	Seismic Velocity	0.5	11.0
		40090055	Surface Hardness	0.3	2.1
		40110277	Neutron Spectra	0.4 ^(a)	5.5
		40120479	Gamma-Ray Spectrometry	2 ^(a)	6.0
		41040281	Magnetism - Telluric	6 ^(a)	4.6
		41050322	Magnetism - Remnant	4 ^(a)	2.0
		41050423	Magnetism - Remnant	6 ^(a)	2.0
		44070742	Near-Surface Temperature	0.2	0.6
		Package Total			22

Footnoted letter notations appear at end of the table.

PACKAGES (Cont.)

Package		Experiment			
ID No.	Name	ID No.	Name	Manhours per Replication	Mass (kg)
99999937	Type I Locale Experiment 1	21010203	Fine-Structure Definition	15	38.0
		21010204	Geologic Mapping	8	28.0
		21010412	30-m Drilling	25	110.0
		21040205	Surface Photogeology	15	5.0
		24030310	Section Measuring	4(a)	28.0
		40130373	Radioactivity	2(b)	1.8
		40140357	Surface Sampling	10(a)	6.0
		21040411	Visual Logging	2	1.7
		40050326	Subsurface Magnetic Susceptibility	2	2.0
		40050338	Subsurface Electrical Permittivity	0.2	4.0
		40060328	Subsurface Self-Potential	2	2.5
		40060334	Subsurface Resistivity	0.2	2.0
		44070343	Bore-Hole Logging Temperature	0.2	0.6
		40010202	Seismic Velocity	3.2	11.0
32010108	Mineralogy and Petrography	10(a)	7.3		
Package Total				100	201.3(b)
99999938	Type I Locale Experiment 2	99999940	Type II Locale Experiment 2	30	223.5
		34010402	Mass Spectrograph	6	6.3
		Package Total			
99999939	Type II, Locale Experiment 1	Same as 99999937 except the replications of the individual experiments differ.			
		Package Total			
99999940	Type II, Locale Experiment 2	11010101	Selenodetic Astronomy	10	150.0
		13030303	Surface Gravity	2.3	27.0
		41010405	Seismic Reflection	8.2(a)	12.0
		41010406	Seismic Profiling	0.0(a)	11.0
		44070742	Temperature Shallow Probe	2.0	0.5
		45030314	Gravity Survey	10.5(a)	30.0
		68030401	Soil Bank	0.0	0.0
		Package Total			
99999941	Type I, Locale Experiment 3	21010203	Fine-Structure Definition	15.0(a)	38.0
		21010204	Geologic Mapping	8.0	28.0
		21020307	10-m Drilling	5	42.0
		21040205	Surface Photography	10(a)	5.0
		24030310	Section Measurements	4(a)	28.0

Footnoted letter notations appear at end of the table.

PACKAGES (Cont.)

Package		Experiment			
ID No.	Name	ID No.	Name	Manhours per Replication	Mass (kg)
99999941	Type I, Locale Experiment 3 (Cont.)	40130373	Radioactivity	2 ^(a)	2.0
		41040357	Surface Sample	10 ^(a)	6.0
		99999912	Logging Package	14	44
		32010108	Mineralogy and Petrography	10.0 ^(a)	7.0
		Package Total			78
99999942	Type II, Locale Experiment 3	21010203	Fine-Structure Definition	10.0 ^(a)	38.0
		21010204	Geologic Mapping	8.0	28.0
		21020307	10-m Drilling	5	42.0
		21040205	Surface Photography	5 ^(a)	5.0
		24030310	Section Measurement	10 ^(a)	28.0
		40130373	Radioactivity	2 ^(a)	2.0
		41040357	Surface Sample	10 ^(a)	6.0
		99999912	Logging Package	14	44
		32010108	Mineralogy and Petrography	10.0 ^(a)	7.0
Package Total			74	200 ^(b)	
99999943	Temporary Base Experiments	32010102	Infrared Chemical Analysis	—	16
		32010105	Wet Chemical Analysis	—	21
		32010106	Density by Floatation	—	0.5
		32010107	X-Ray Diffractometry	—	9
		32010110	Mass Spectrometry	—	23
		32010111	Neutron Activation	—	16
		32010112	X-Ray Fluorescence	—	7
		Package Total			600 (per month)
99999944	Permanent Base Experiments	32010102	Infrared Chemical Analysis	—	16
		32010103	NMR Spectrometry	—	20
		32010105	Wet Chemical Analysis	—	21
		32010106	Density by Floatation	—	0.5
		32010107	X-Ray Diffractometry	—	9
		32010108	Microminerology	—	7
		32010110	Mass Spectrometry	—	23
		32010111	Neutron Activation	—	16
		32010112	X-Ray Fluorescence	—	7
		52020101	Solar Charged Particles, Low Energy	—	5
		52020102	Solar Charged Particles, High Energy	—	25
		52030101	Galactic 'Nuclei'	—	110

Footnoted letter notations appear at end of the table.

PACKAGES (Cont.)

Package		Experiment			
ID No.	Name	ID No.	Name	Manhours per Replication	Mass (kg)
99999944	Permanent Base Experiments (Cont.)	52090101	Neutrino Flux	-	460
		53010101	Solar Wind	-	5
		53050101	Magnetic Field	-	5
		80200101	Clinical Monitoring	-	14
		80200601	Psychological Testing	-	7
		80201001	Cardiovascular Phenomena	-	7
		80201101	Bone Demineralization	-	65
		80300101	Evaluation of Algae	-	320
		80300102	Lunar Soil Use by Higher Plants	-	300
		80300104	Plant Growth, Development and Reproduction	-	470
		80300202	Animal Growth, Development and Reproduction	-	470
80340303	Exposure Effects on Materials	-	1		
Package Total				1,200 (per month)	2,400
99999945	Photographic Orbiter, Unmanned	21040101	Geologic Base Maps	-	155
		32010116	UV and Visible Spectra	-	15
		32010117	IR Spectra	-	15
		33010102	Gamma-Ray Spectrometry	-	32
Package Total				-	220
99999946	Early Emplaced Scientific Station	-	Magnetic Field	-	6
		-	Ion Detection	-	3
		-	Thermal Conductance	-	1
		-	Passive Seismology	-	9
		-	Electron/Proton Flux	-	3
		-	Active Seismology	-	3
		-	Solar Wind	-	5
Package Total				2	68(f)
99999947	Advanced Emplaced Scientific Station	-	Ion Gauge	-	3
		-	Mass Spectrometer	-	7
		-	Ion Analyzer	-	3
		-	UV Spectrometer	-	3
		-	Meteoroid Detector	-	30
		-	Electric-Field Detector	-	4

Footnoted letter notations appear at end of the table.

PACKAGES (Cont.)

Package		Experiment			
ID No.	Name	ID No.	Name	Manhours per Replication	Mass (kg)
99999947	Advanced Emplaced Scientific Station (Cont.)	-	Plasma Probe	-	5
		-	Charged-Particle Analyzer	-	5
		-	Nuclear Emulsions	-	1
		-	Scintillometer	-	7
		-	Magnetometer	-	7
		-	VLF Field Meter	-	2
		-	Gravimeter	-	14
		-	Seismometer (passive)	-	9
		-	Geophones	-	3
		-	Radiometer	-	1
		-	Temperature Probe	-	2
		-	Corner Reflector	-	2
		-	Star Tracker	-	9
Package Total				12	220 ^(f)

- (a) Accounts for several replications per package.
- (b) Total mass adjusted for equipment commonality.
- (c) Total manhours allocated for purposes of mission-mode matching.
- (d) Automatic experiment.
- (e) Total mass does not include major scientific equipment.
- (f) Includes power supply and structure.

Appendix B

EXPLORATION PROGRAM SUMMARIES
EXPLORATION PROGRAMS I, II, AND III

Page Intentionally Left Blank

EXPLORATION PROGRAM I

PROGRAM I GENERAL DESCRIPTION

This lunar exploration program evolves from a decision to develop Saturn/Apollo Applications (S/AA) hardware which is then utilized until the mid 1980's. The initial hardware consists of augmented Apollo equipment providing up to 14-day staytimes and limited mobility (total range ~ 30 Km). The later missions (after mission 14) utilize a pickup launch, where the crew is delivered and retrieved in separate launches, in order to allow for staytimes in excess of 14 days, and to provide access to the entire lunar surface.

Fourteen locales, which are shown on the Lunar Surface Pattern in Appendix A, page A-4, are visited in the following order: 17-3-13-26-1-21-11-29-2-4-12-7-15-16.

Annual costs are constrained not to exceed \$1.5 billion per year. Launch rates are constrained not to exceed three per year through 1979 and four per year thereafter.

With these objectives and constraints, Exploration Program I introduces operation of the pickup launch in 1975. The total number of Saturn launches is 51, including six Apollo missions and one test launch (personnel pickup system). The total post-Apollo cost is \$14.8 billion spread over about 17 years. The program indicates a non-recurring cost of about \$0.9 billion for development of the S/AA capability hardware for which funds must be committed beginning in FY 1968.

LUNAR SCIENTIFIC PROGRAM I

Program I constitutes that portion of the integrated scientific program which can be accomplished with S/AA lunar exploration equipment capability. The scope of scientific goals in this program is expressed by the 15 basic questions about the Moon formulated at the 1965 Summer Conference of the Space Science Board at Woods Hole, Massachusetts. Hence, the scientific investigations and experiments are directed almost exclusively to exploration of the Moon with a negligible effort involving extralunar goals, e.g., astronomy.

The lunar surface exploration pattern is shown in Appendix A, page A-4. The locale approach is used throughout this program because the permitted range of surface traverse is restricted to a radius of about 10 km from the landing sites. Fourteen locales were selected representing a widely dispersed sampling of major features and providing opportunities to make ground-truth observations essential to the most general interpretation of lunar orbiter survey data. Three of the locales were selected for their unique qualities. They are Mare Orientale, a partially filled impact basin expected to yield an understanding of the mechanism and history of the formation of maria; Center Farside, which is an important site for lunar gravity measurements and surface structure, composition and subsurface structure determinations to shed light on the gross configuration, asymmetry and degree of differentiation of the Moon; and the South Pole, an area of prime interest concerning formations shielded from the cyclic erosive effects of solar radiation and possible deposits of frozen volatile materials.

No major scientific equipment is called out in Program I. The 300-m core drill would have been most desirable because core samples from the greatest possible range of depths are needed to provide data concerning the elastic parameters of subsurface materials. These data are essential to an accurate interpretation of results from seismic experiments. The best compromise on deep drilling within S/AA capabilities was estimated to be a 100-m core drill, which was used at three locales. The 100-m drill is not treated as an item of major scientific equipment in this study.

The total mass of minor scientific equipment employed in this program is 22,000 kg, of which 17,000 kg represents geoscientific equipment. An additional 14,000 kg of explosives are delivered to the lunar surface for active seismology experiments.

A total of 4,200 manhours is expended in scientific activity in this program, of which 3,200 manhours are assigned to lunar geoscientific experiments.

PROGRAM I SUMMARY

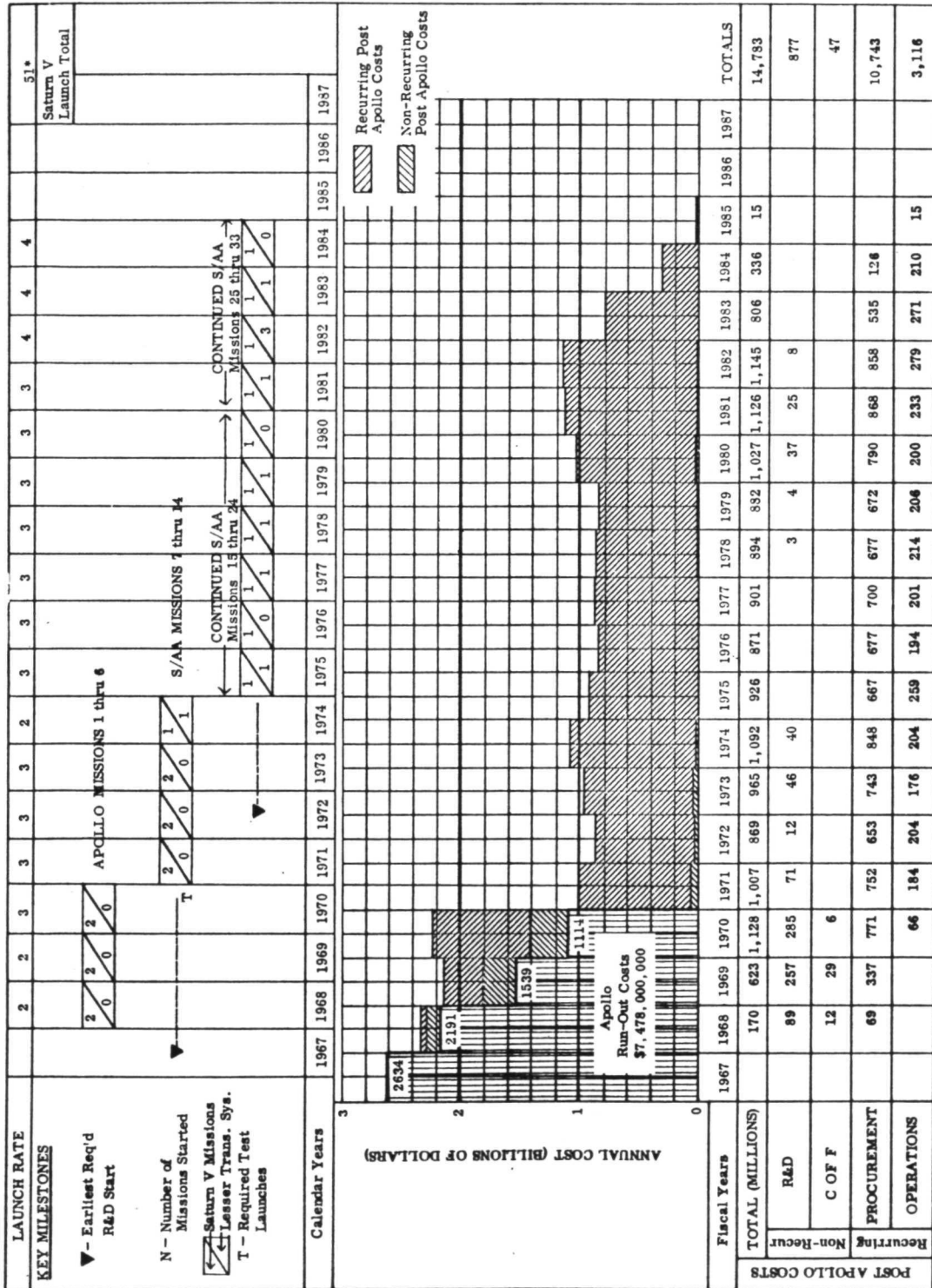

PROGRAM I POST-APOLLO MISSION SUMMARY

No.	Start	Mission		Mode Identification Number	Number of Saturn V Launches	Map Reference	Stay Time (days)	Total Man-hours	Scientific Man-hours	Total Cargo (kg)	Scientific Equipment (kg)	Mass Reserve (kg)	Total Traverse (km)
		Location (paths - locales)											
7	71A	Manned Orbiter No. 1		303-11001-01	1	-	27.6	1,989	(654)	(14,072)	(1,818)	(7,442)	-
8	71B	Ranger 8 Locale		402-11001-01	2	17	13.2	631	106	9,253	1,003	1,917	194
9	72A	Manned Orbiter No. 2		303-11001-01	1	-	27.6	1,989	(654)	(14,072)	(1,818)	(7,442)	-
10	72B	Capella M Locale		402-11001-01	2	3	12.5	600	97	9,096	846	2,074	194
11	73A	Manned Orbiter No. 3		303-11001-01	1	-	27.6	1,989	(654)	(14,072)	(1,818)	(7,442)	-
12	73B	Oceanus Procellarum Locale		402-11001-01	2	13	12.3	588	94	9,180	980	1,990	190
13	74B	Photographic Orbiter No. 1		200-11001-01	-	-	-	-	-	(1,060)	(0)	(52)	-
14	74B	Moltke B Locale		402-11001-01	2	26	12.4	596	95	9,431	1,181	1,739	200
15	75A	Photographic Orbiter No. 2		200-11001-01	-	-	-	-	-	(1,060)	(0)	(52)	-
16	75A	Hyginus Rille Locale		402-11011-01	3	1	11.8	568	101	7,798	470	1,942	136
17	76A	Grimaldi Locale		402-11011-01	3	21	13.6	653	118	7,803	475	1,937	146
18	77A	Photographic Orbiter No. 3		200-11001-01	-	-	-	-	-	(1,060)	(0)	(52)	-
19	77A	Tycho Locale		402-11011-01	3	11	12.5	602	94	9,307	979	1,433	203
20	78A	Photographic Orbiter No. 4		200-11001-01	-	-	-	-	-	(1,060)	(0)	(52)	-
21	78A	Copernicus Locale		402-11011-01	3	29	12.9	618	96	7,815	487	1,925	224
22	79A	Photographic Orbiter No. 5		200-11001-01	-	-	-	-	-	(1,060)	(0)	(52)	-
23	79A	Alphonsus Locale		402-11011-01	3	2	13.5	648	110	7,948	620	1,792	188
24	80A	Hadley's Rille Locale		402-11011-02	3	4	25.3	1,213	218	9,646	1,296	94	365
25	81A	Communications Orbiter No. 1		200-11021-01	-	-	-	-	-	(?)	(?)	(?)	-
26	81A	Mare Orientale Locale		402-11011-02	3	12	24.7	1,184	210	9,666	1,316	74	362
27	82A	Marius Hills Locale		402-11041-02	4	7	29.0	1,392	290	11,679	2,218	2,461	220
28	82B	Explosives Delivery Probe No. 1		100-11011-01	-	-	-	-	-	(6,100)	(5,900)	(0)	-
29	82B	Explosives Delivery Probe No. 2		100-11011-01	-	-	-	-	-	(6,100)	(5,900)	(0)	-
30	82B	Photographic Orbiter No. 6		200-11001-01	-	-	-	-	-	(1,060)	(0)	(52)	-
31	83A	Communications Orbiter No. 2		200-11021-01	-	-	-	-	-	(?)	(?)	(?)	-
32	83A	Central Farside Locale		402-11041-02	4	15	29.3	1,406	289	12,235	2,764	1,905	251
33	84A	South Pole Locale		402-11041-02	4	16	28.8	1,381	282	12,078	2,620	2,062	252
Total					44		334.6	18,047	2,200*	131,935*	17,205*	23,345*	3,125

*Parenthetical Data Not Included In Sums Nor In Cumulative Performance Calculations.

PROGRAM I EQUIPMENT USAGE AND COST SUMMARY

ID No.	Equipment Identification		R&D Start	First/Last Use	Number Procured		Cost Summary (Millions of Dollars)				Total Cost	
	Name	Operations			Test & Spares	Nonrecurring		Recurring		Operation		
						R&D	C of F	Procurement	Operation			
1211-01	<u>LAUNCH VEHICLES</u>											
1212-01	Atlas-Agena		-	70A/70A	0	2	.0	.0	6.4	1.5	7.9	
1213-01	Atlas-Centaur		-	74B/83A	8	1	.0	.0	203.4	35.1	238.5	
1231-04	Saturn IB-Centaur		79B	82B/82B	2	1	64.0	.0	150.0	30.0	244.0	
	111% Saturn V		67B	71A/84A	44	5	387.0	53.0	4,663.5	896.7	6,000.2	
	SUBTOTAL						451.0	53.0	5,023.3	963.3	6,490.6	
1311-03	<u>FLIGHT SYSTEMS</u>											
1324-02	Command Module LOR - 3 Man		-	71B/84A	41	5	.0	.0	2,643.9	694.6	3,338.5	
1331-02	Service Module LOR		67B	71A/84A	44	5	42.8	.0	1,119.4	215.6	1,377.8	
	Descent Stage LOR		68B	71B/84A	31	4	46.6	.0	1,622.2	133.0	801.8	
	SUBTOTAL						89.4	.0	4,385.5	1,043.2	5,518.1	
2121-01	<u>MISSION EQUIPMENT</u>											
2211-03	Orbit Launched Probe		68B	71A/73A	24	3	57.5	.0	78.4	8.1	144.0	
2222-02	Unmanned Orbiter		71B	74A/79A	6	1	73.0	.0	64.2	4.2	143.4	
2321-03	Orbiter Rack		69A	71A/73A	3	3	1.0	.0	2.4	.0	3.4	
2421-01	Manned Orbiter - 3 Man		-	71A/73A	3	1	.0	.0	243.0	60.4	303.4	
2511-02	Personnel Shelter - 2 Man (ALM)		68A	71B/84A	14	2	117.0	.0	576.4	147.2	840.6	
2711-13	LRV - No Cabin		68B	71B/84A	28	3	58.0	2.0	122.8	15.5	198.3	
2712-99	LFV Exploration - 1 Man		72B	75A/84A	8	1	9.2	.0	6.3	.0	15.5	
	LFV Fuel Resupply		-	75A/84A	8	1	.0	.0	.0	.0	.0	
	ALM Shelter Resupply		77B	80A/84A	5	1	7.4	.0	.0	.0	7.4	
	SUBTOTAL						325.1	2.0	1,093.5	235.4	1,656.0	
	TOTAL						865.5	55.0	10,502.3	2,241.9	13,664.7	

PROGRAM I
SCIENTIFIC PROGRAM OPERATIONAL SUMMARY

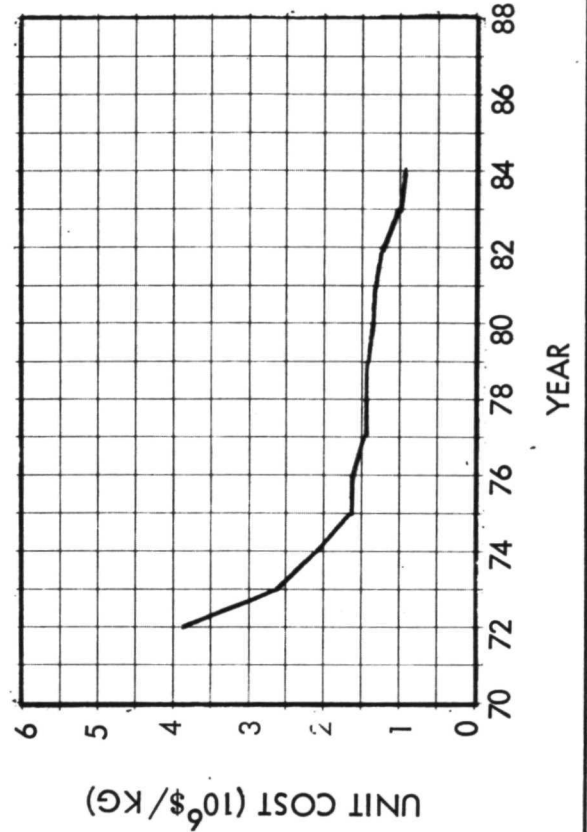
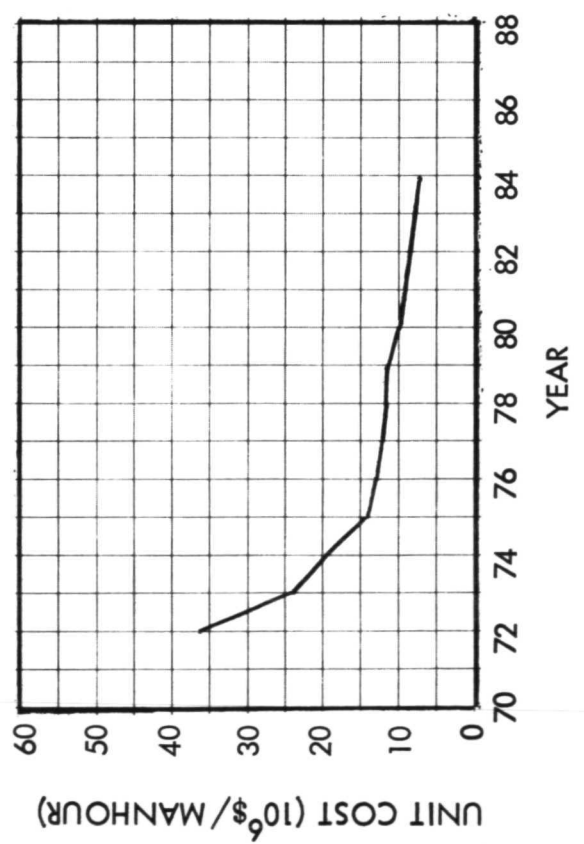
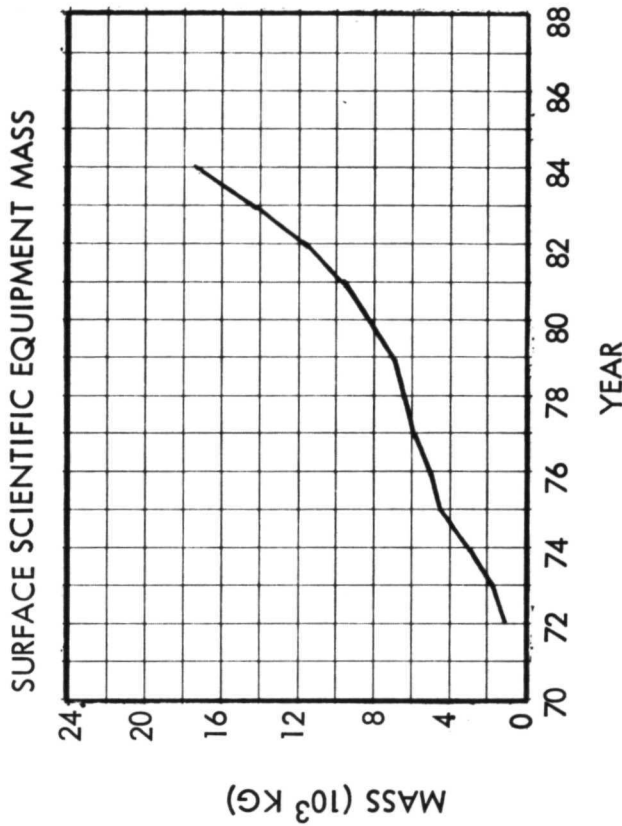
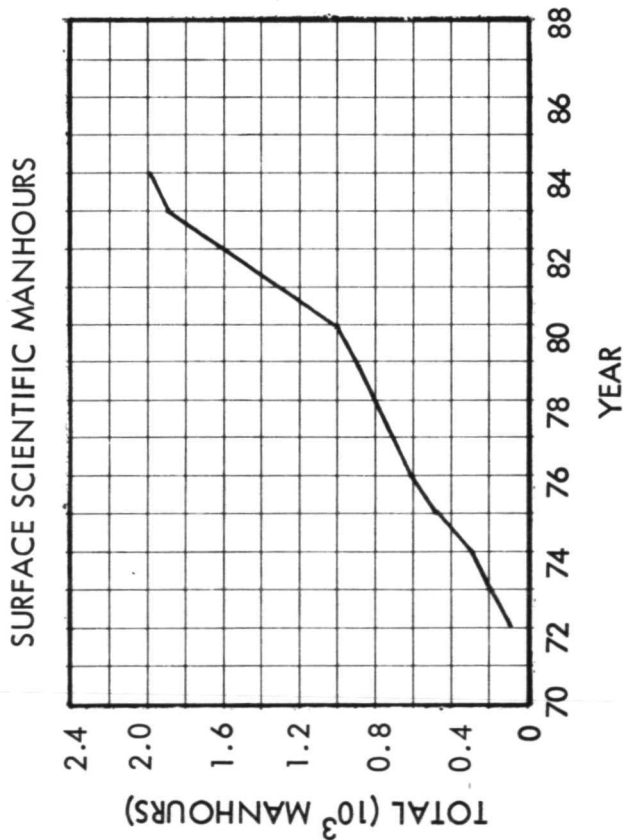

Page Intentionally Left Blank

EXPLORATION PROGRAM II

PROGRAM II GENERAL DESCRIPTION

This lunar exploration program evolves from a first decision to introduce Saturn/Apollo Applications (S/AA) hardware in FY 1971. This hardware consists of augmented Apollo equipment providing up to 14-day stay-times and limited mobility (total range ~ 30 km). A second decision is made to introduce medium capability hardware in FY 1975. This hardware consists of an uprated Saturn V (111%), a Lunar Logistics Vehicle (LLV), and a three-man Lunar Roving Vehicle (LRV) with a range up to 1600 km. Finally, as a result of a third decision to continue at the medium capability level, additional equipment is introduced in FY 1981. This equipment consists of a long duration six-man shelter with nuclear power.

Nine locales, which are shown on the lunar surface pattern in Appendix A, page A-10, are visited in the following order: 17-3-13-26-1-21-29-16-27. Fifteen paths are traversed in the following order: n-d-g-h-c-e-f-a-b-j-m-i-k-l-t.

Annual costs are constrained not to exceed \$1.5 billion per year. Launch rates are constrained not to exceed 3 per year through 1977, 4 per year through 1983, and 6 per year thereafter.

A total of 85 Saturn launches are used including 6 Apollo missions and 1 test launch (for the LLV). The total post-Apollo cost is \$23.8 billion spread over about 23 years. The program indicates a nonrecurring cost of about \$1.0 billion for development of the medium capability hardware, for which funds must be committed in FY 1970.

LUNAR SCIENTIFIC PROGRAM II

Program II follows precisely the pattern of Program I through the first eight S/AA lunar missions and then uses the option of an early uprating of the transport system to increase the payload and extend the staytime on the lunar surface. The scope of the scientific program is broadened by 10 basic questions, in addition to the 15 questions about the Moon formulated at Woods Hole. The 10 additional questions identify extralunar goals in the areas of astronomy, planetology, solar physics, biology, oceanography, and meteorology.

The lunar surface exploration pattern for Program II, shown in Appendix A, page A-10, emphasizes the path approach because the uprated transport system permits delivery of surface rovers with trailers that provide life support and range sufficient to accomplish traverses of several months' duration and of distances greater than 1,000 km. For scientific exploration of the Moon, the path approach is much preferred over the locale approach because the path approach favors the conduct of gravitational and magnetic surveys across large lunar features, permits systematic sampling and inspection of contacts between different geologic formations, and facilitates the use of active seismology in probing the deep lunar subsurface structure. Program II comprises 14 paths, representing a total path length of 7,500 km, and 9 locales. Except for the crater Tycho, the path approach in Program II provides for visiting all of the locales in Program I, in addition to many more points of interest than could be incorporated in any feasible program based on the locale approach.

The major scientific equipment used in Program II includes 300-m core drills at 5 different places on the Moon and an array of radio, optical, and x-ray telescopes associated with a six-man base at Grimaldi. The total mass of major scientific equipment is 130,000 kg, which is about three and a half times the 36,500 kg of minor scientific equipment employed in this program.

About 42,000 kg of explosives are delivered to the Moon in connection with active seismic experiments. Only about 12,000 kg are soft-landed and deployed by men. The bulk of explosives is delivered directly by unmanned direct delivery and detonated at the desired sites in a hard-landing mode.

A total of 58,000 scientific manhours is expended in this program, of which 22,000 manhours are assigned to geoscientific activities and 27,000 manhours to astronomy.

PROGRAM II SUMMARY

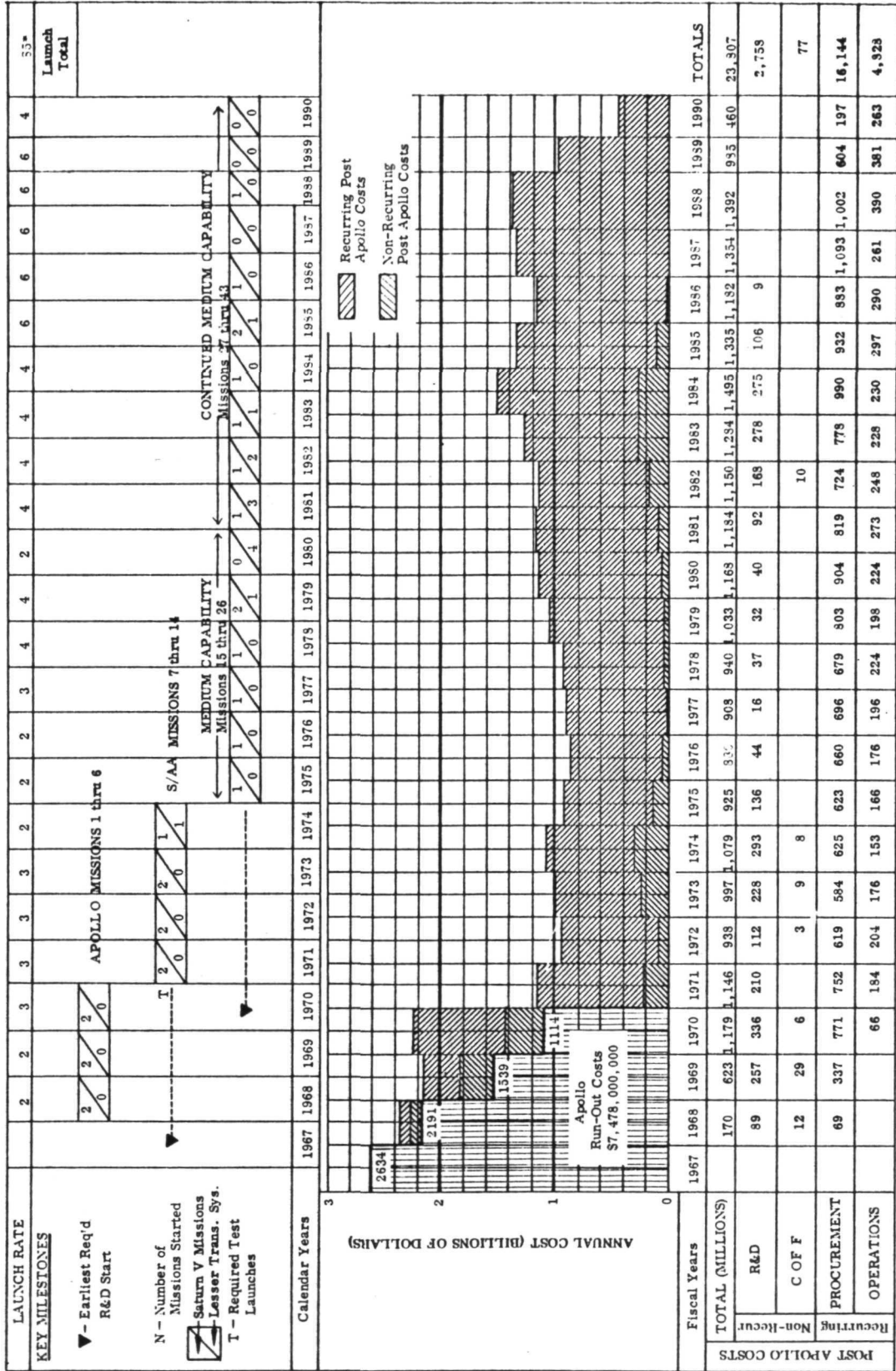

PROGRAM II POST-APOLLO MISSION SUMMARY

No.	Start	Mission		Mode Identification Number	Number of Saturn V Launches	Map Reference	Stay Time (days)	Total Man-hours	Scientific Man-hours	Total Cargo (kg)	Scientific Equipment (kg)	Mass Reserve (kg)	Total Traverse (km)
		Location (paths - locales)											
7	71A	Manned Orbiter No. 1		303-11001-01	1	-	27.6	1,989	(654)	(14,072)	(1,818)	(7,442)	-
8	71B	Ranger VIII Locale		402-11001-01	2	17	13.2	631	106	9,253	1,003	1,917	194
9	72A	Manned Orbiter No. 2		303-11001-01	1	-	27.6	1,989	(654)	(14,072)	(1,818)	(7,442)	-
10	72B	Capella M Locale		402-11001-01	2	3	12.5	600	97	9,096	846	2,074	194
11	73A	Manned Orbiter No. 3		303-11001-01	1	-	27.6	1,989	(654)	(14,072)	(1,818)	(7,442)	-
12	73B	Oceanus Procellarum Locale		402-11001-01	2	13	12.3	588	94	9,180	930	1,990	190
13	74B	Photographic Orbiter No. 1		200-11001-01	2	-	-	-	-	(1,060)	(0)	(52)	-
14	74B	Moltke B Locale		402-11001-01	2	26	12.4	596	95	9,431	1,181	1,739	200
15	75B	Hyginus Rille Locale		503-21001-01	2	1	13.0	935	280	7,886	986	6,214	80
16	76A	Grimaldi Locale		503-21001-01	2	21	12.6	910	271	8,615	1,715	5,485	80
18	77A	Copernicus Locale and Path N		503-21001-02	3	29	33.3	2,401	724	13,432	6,502	668	400
19	78A	Path D		503-21002-02	4	-	82.0	5,903	1,787	27,313	15,279	887	500
20	79A	Path G and Path H		503-21002-01	3	-	67.0	4,824	1,372	12,744	1,091	1,356	900
21	79B	Photographic Orbiter No. 2		200-11001-01	-	-	-	-	-	(1,060)	(0)	(52)	-
22	79B	Path C, Path E, and Path F		503-21002-01	3	-	74.0	5,330	1,341	12,600	948	1,500	1,600
23	80B	Explosives Delivery Probe No. 1		100-11011-01	-	-	-	-	-	(6,100)	(5,900)	(0)	-
24	80B	Explosives Delivery Probe No. 2		100-11011-01	-	-	-	-	-	(6,100)	(5,900)	(0)	-
25	80B	Photographic Orbiter No. 3		200-11001-01	-	-	-	-	-	(1,060)	(0)	(52)	-
26	80B	Photographic Orbiter No. 4		200-11001-01	-	-	-	-	-	(1,060)	(0)	(52)	-
27	81A	Path A and Path B		503-21002-02	4	-	90.3	6,502	1,880	27,102	15,035	1,098	900
28	81B	Explosives Delivery Probe No. 3		100-11011-01	-	-	-	-	-	(6,100)	(5,900)	(0)	-
29	81B	Explosives Delivery Probe No. 4		100-11011-01	-	-	-	-	-	(6,100)	(5,900)	(0)	-
30	81B	Photographic Orbiter No. 5		503-21002-02	4	-	56.1	4,036	1,123	26,690	14,667	1,510	600
31	82A	Path J		100-11011-01	-	-	-	-	-	(6,100)	(0)	(52)	-
32	82A	Explosives Delivery Probe No. 5		200-11001-01	-	-	-	-	-	(1,060)	(0)	(52)	-
33	82A	Photographic Orbiter No. 6		200-11021-01	-	-	-	-	-	(1,060)	(0)	(52)	-
34	83A	Communications Orbiter No. 1		503-21002-03	4	-	86.1	6,200	1,627	25,067	12,820	3,133	1,200
35	83A	Grimaldi Base and Path M		503-21002-03	4	21	-	-	-	(?)	(?)	(?)	-
36	84A	South Pole Locale and Path I		503-21002-02	4	16	56.4	4,064	1,159	28,340	15,317	0+	500
37	85A	Communications Orbiter No. 2		200-11021-01	-	-	-	-	-	(?)	(?)	(?)	-
38	85A	Path K		503-21001-02	3	-	32.7	2,351	583	13,068	6,148	1,032	800
39	85B	Path L		503-21002-02	4	-	58.9	4,239	1,135	26,696	14,673	1,504	800
40	86A	Grimaldi Base		406-21001-01	3	21	898.7	129,406	41,306	158,783	100,318	10,417	240
41	88B	North Pole Locale and Path T		503-21002-01	8	27	44.6	3,212	951	13,444	1,864	656	400
42	87B	Supplement to Mission 40		406-21001-02	8	21	-	-	-	-	-	-	-
43	89A	Supplement to Mission 40		406-21001-03	8	21	-	-	-	-	-	-	-
Total					78			188,695	55,931*	438,740*	211,323*	42,900*	9,778

*Parenthetical Data Not Included in Sums Nor in Cumulative Performance Calculations.
+Expendables Offloaded to Increase Mass of Other Cargo.

PROGRAM II EQUIPMENT USAGE AND COST SUMMARY

ID No.	Equipment Identification		R&D Start	First/Last Use	Number Procured		Cost Summary (Millions of Dollars)				Total Cost
					Operations	Test & Spares	Nonrecurring		Recurring		
							C of F	R&D	Procurement	Operation	
LAUNCH VEHICLES											
1211-01	Atlas - Agena				0	2	.0	.0	6.4	1.5	7.9
1212-01	Atlas-Centaur		70A 70A	8	1	1	.0	203.4	35.1	238.5	
1213-01	Saturn 1B-Centaur		74B 85A	5	1	1	64.0	300.0	60.0	424.0	
1214-01	Saturn 1B		80B 82A	0	2	2	.0	.0	.0	.0	
1231-04	Saturn V		75A 75A	75	3	3	387.0	7,528.5	1,573.8	9,542.3	
	SUBTOTAL		71A 90B				451.0	53.0	8,038.3	1,670.4	10,212.7
FLIGHT SYSTEMS											
1311-03	Command Module LOR - 3 Man		71B 74B	8	1	1	.0	.0	547.4	135.9	683.3
1313-02	Command Module LOR - 4 Man		75B 90B	36	4	4	62.4	.0	2,341.3	601.0	3,007.7
1324-02	Service Module LOR		67B 71A 90B	47	5	5	42.8	.0	1,184.3	228.8	1,455.9
1331-02	Descent Stage LOR		71B 90B	44	5	5	46.6	.0	849.8	186.2	1,052.6
1342-02	Personnel Ascent Stage LOR - 3 Man		75B 90B	36	4	4	.0	.0	1,322.2	360.0	1,682.2
1442-08	Logistics Braking and Landing Stage		75B 89B	31	4	4	420.0	20.0	467.4	80.5	987.9
	SUBTOTAL						571.8	20.0	6,712.4	1,593.4	8,899.6
MISSION EQUIPMENT											
2121-01	Orbit Launched Probe		71A 73A	24	3	3	57.5	.0	78.3	8.1	143.9
2221-03	Unmanned Orbiter		74B 82A	6	1	1	75.0	.0	64.2	4.2	143.4
2222-02	Orbiter Rack		71A 73A	3	3	3	1.0	.0	2.4	.0	3.4
2321-03	Manned Orbiter - 3 Man		71A 73A	3	1	1	.0	.0	243.2	60.4	303.6
2321-05	Personnel Shelter - 2 Man (ALM)		71B 74B	4	1	1	117.0	.0	186.4	46.0	349.4
2325-03	Personnel Shelter - 6 Man		81A 86A 86A	1	1	1	415.4	.0	82.3	11.0	508.7
2421-01	LRV No Cabin		69A 71B 86A	10	1	1	58.0	2.0	51.6	5.5	117.1
2423-04	LRV - 3 Man, 30 Day, 800 km		70A 75B 88B	14	2	2	328.0	.0	191.7	.0	519.7
2434-xx	Trailer, Multipurpose		75B 78A 88B	11	2	2	23.5	.0	20.8	.0	44.3
2511-02	LFV - Exploration - 1 Man		73A 75B 88B	13	2	2	9.2	.0	9.8	.0	19.0
2711-13	LFV Fuel Resupply		75B 88B	13	2	2	.0	.0	.0	.0	.0
2722-04	Nuclear Power Supply (Isotope)		80B 86A 86A	1	1	1	58.6	10.0	59.6	.0	128.2
	SUBTOTAL						1,143.2	12.0	990.3	135.2	2,280.7
MAJOR SCIENTIFIC EQUIPMENT											
3213-02	300 Meter Drill with Fuel Cell		79A 85B	5	1	1	11.3	.0	10.8	.0	22.1
3222-01	Radio Telescope - Mills Cross		83A 83A	1	1	1	2.0	.0	1.1	.0	3.1
3223-01	15 Meter Parabolic Radio Telescope		82B 86A 86A	1	1	1	4.1	.0	3.6	.0	7.7
3224-01	Radio Telescope Mills Cross		80B 86A 86A	1	1	1	30.0	.0	8.0	1.0	39.0
3231-01	X-Ray Telescope		86A 86A	1	1	1	38.8	.0	6.2	1.0	46.0
3231-02	X-Ray Telescope Wide Angle		83A 83A	1	1	1	.0	.0	.0	.0	.0
3242-02	Optical Telescope 1 Meter		80B 83A 83A	1	1	1	28.7	.0	11.2	1.0	40.9
3242-05	Optical Telescope Solar		80B 86A 86A	1	1	1	122.0	.0	54.4	.0	176.4
3243-01	Optical Telescope 2.5 Meter		79B 86A 86A	1	1	1	226.8	.0	31.2	1.4	259.4
	SUBTOTAL						463.7	.0	126.5	4.4	594.6
TOTAL							2,629.7	85.0	15,867.5	3,405.4	21,987.6

PROGRAM II
SCIENTIFIC PROGRAM OPERATIONAL SUMMARY

SURFACE SCIENTIFIC MANHOURS

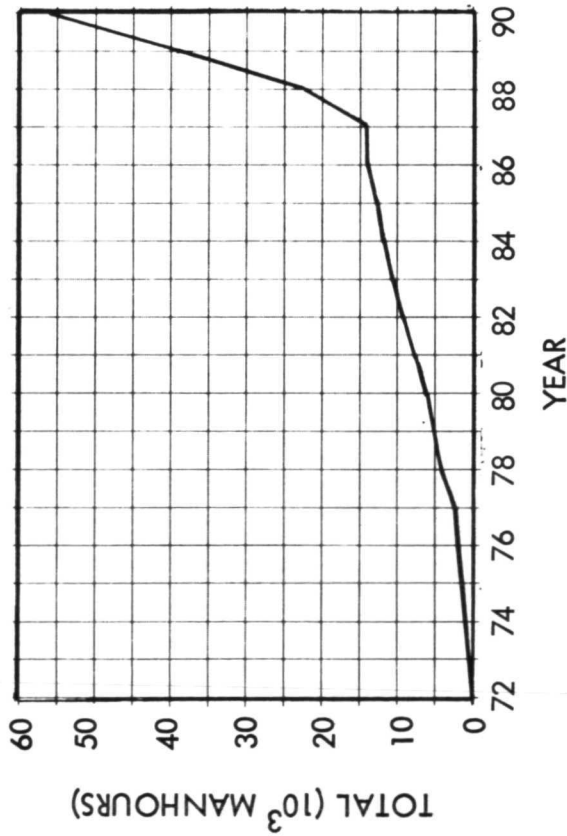

SURFACE SCIENTIFIC EQUIPMENT MASS

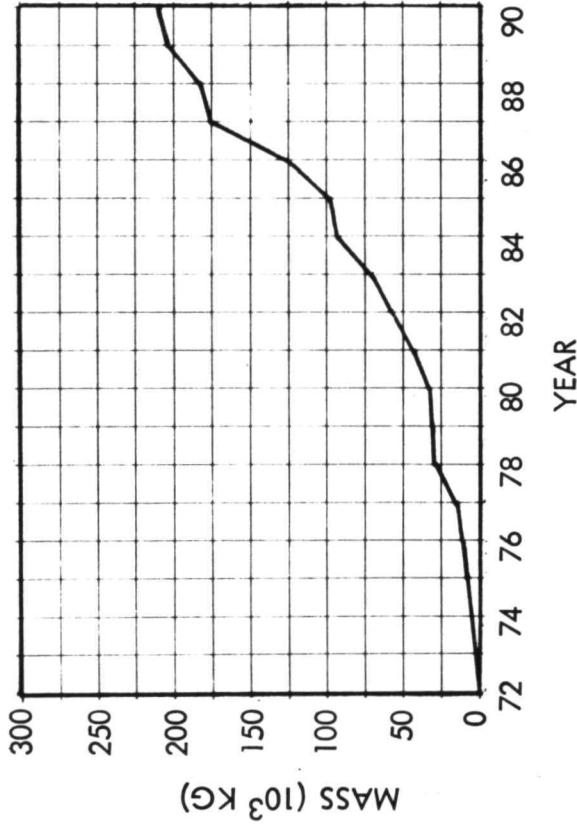

UNIT COST (10⁶\$/MANHOUR)

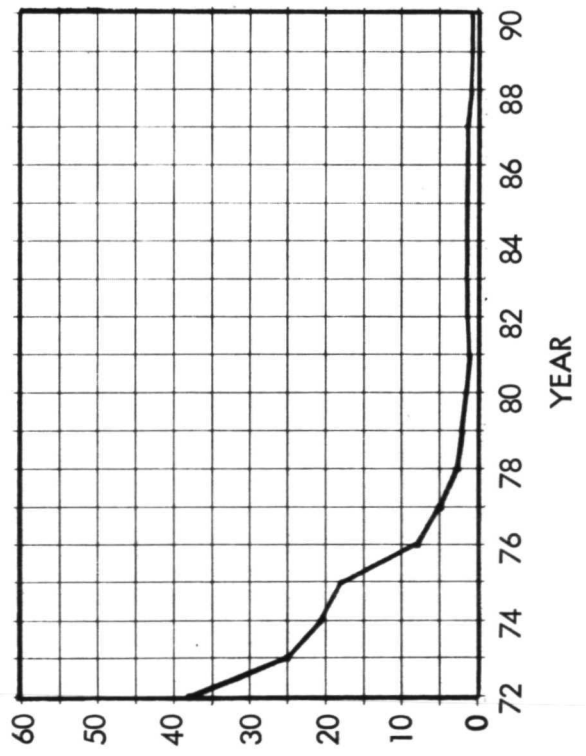

UNIT COST (10⁶\$/KG)

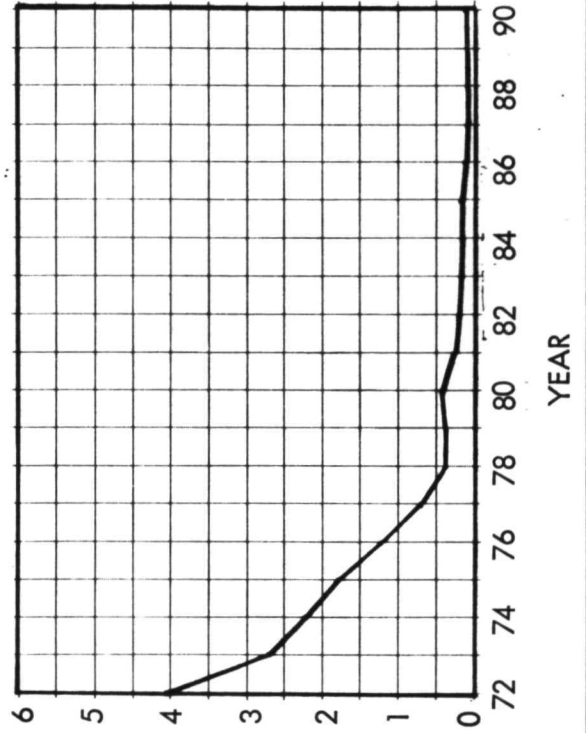

Page Intentionally Left Blank

EXPLORATION PROGRAM III

PROGRAM III GENERAL DESCRIPTION

This lunar exploration program evolves from a first decision to introduce Saturn/Apollo Applications (S/AA) hardware in FY 1971. This hardware consists of augmented Apollo equipment providing up to 14-day staytimes and limited mobility (total range ~ 30 km). A second decision is made to introduce medium capability hardware in FY 1975. This equipment consists of an uprated Saturn V (111%), a Lunar Logistics Vehicle (LLV), and a three-man Lunar Roving Vehicle (LRV), with a range up to 1600 km. Finally, as a result of a third decision to develop large capability hardware, new equipment is introduced in FY 1981. This consists of an uprated Saturn V (188%), a direct six-man delivery system, and a twelve-man long-duration shelter with nuclear power.

Nine locales, which are shown on the lunar surface pattern in Appendix A, page A-16, are visited in the following order: 17-3-13-26-1-21-29-16-27. Fifteen paths are traversed in the following order: n-d-g-h-c-e-f-a-b-h-m-1-k-l-t.

Annual costs are constrained not to exceed \$1.5 billion/year. Launch rates are constrained not to exceed 3 per year through 1976, 4 per year through 1981, and 6 per year thereafter.

A total of 69 Saturn launches are used including 6 Apollo missions, and 3 test launches (1 for the LLV and 2 for the Saturn upratings). The total post-Apollo cost is \$22.9 billion spread over about 22 years. The program indicates a cost of about \$1.0 billion for development of the medium capability hardware for which funds must be committed in FY 1970. The program also indicates a cost of about \$2.8 billion for development of the large capability hardware for which funds must be committed beginning in FY 1977.

LUNAR SCIENTIFIC PROGRAM III

Program III follows exactly the schedule of Program II through the 19th mission, whereupon a second option to uprate the transport system is used. Program III pursues a scientific program with the same goals and scope of Program II, i. e., the 15 basic questions about the Moon and the 10 questions about extralunar goals provide the guidelines for identifying required scientific investigations and selecting appropriate scientific experiments.

The lunar surface exploration pattern for Program III with emphasis upon the path approach is precisely the same as for Program II, i. e., 14 paths with a total length of 7,500 km and 9 locales.

The second uprating of the transport system permits a more generous use of major scientific equipment. There are 8 locations in Program III where a 300-m core drill is used, and 1-m optical telescopes are set up at the South Pole and at the Center Farside to evaluate the potentialities of these locations for lunar-based astronomy. A 12-man permanent base for astronomy, biology, and applied science is established at Grimaldi. The total mass of major scientific equipment is 154,000 kg, of which 56,000 kg consists of deep drills. The remainder comprises a variety of telescopes. The minor scientific equipment mass is 38,500 kg, two-thirds of which is geoscientific instrumentation.

A total mass of 47,500 kg of explosives is used for active seismology on the Moon. A direct delivery mode with detonation upon impact at the desired sites is used for 30,000 kg of these explosives. The remainder is soft-landed and deployed by men.

Approximately half of the 99,500 scientific manhours in this program is assigned to astronomy, while slightly more than a third is used for geoscience.

PROGRAM III SUMMARY

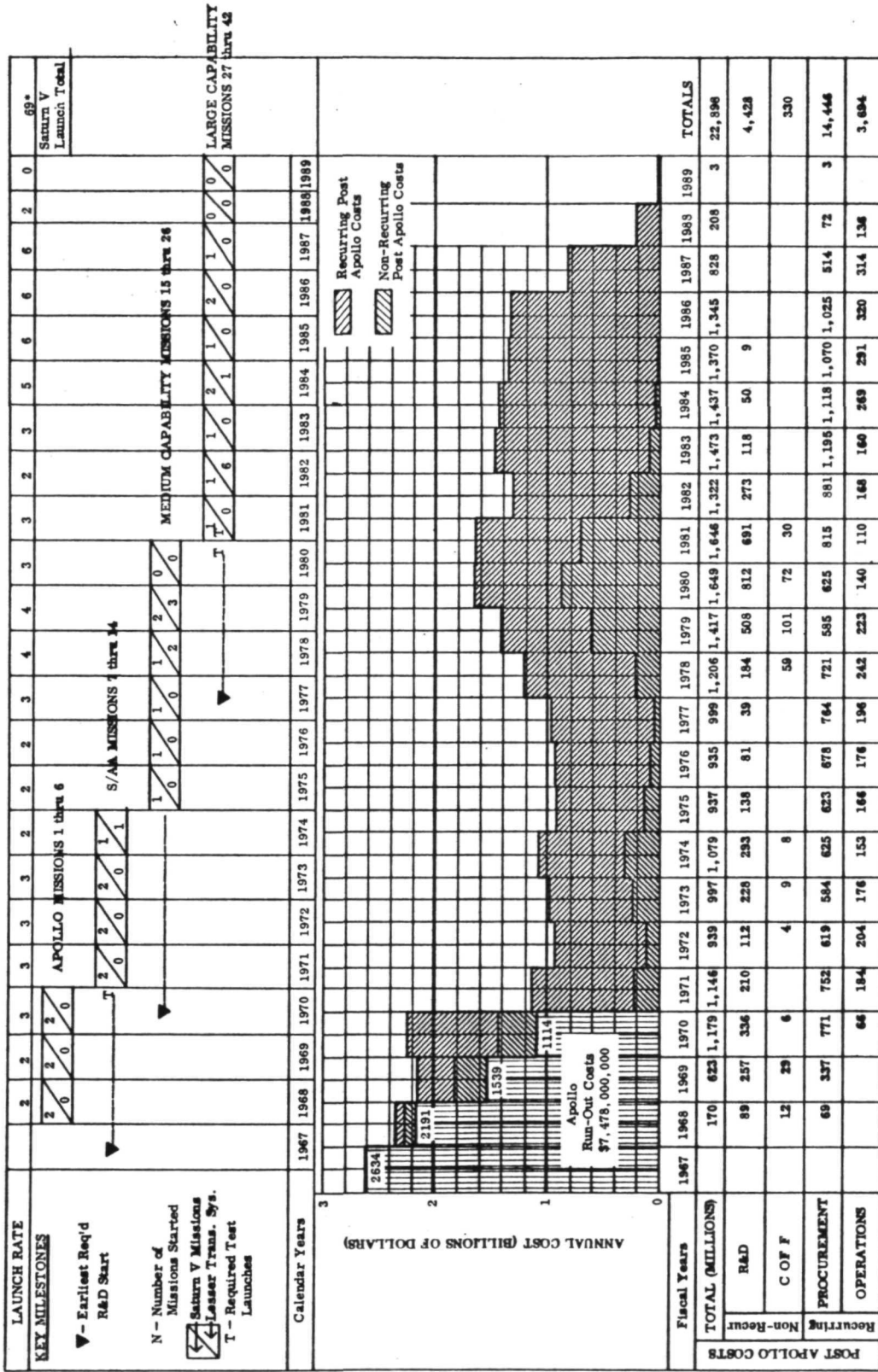

PROGRAM III POST-APOLLO MISSION SUMMARY

No.	Start	Mission		Mode Identification Number	Number of Saturn V Launches	Map Reference	Stay Time (days)	Total Man-hours	Scientific Man-hours	Total Cargo (kg)	Scientific Equipment (kg)	Mass Reserve (kg)	Total Traverse (km)
		Location (paths - locales)											
7	71A	Manned Orbiter No. 1		303-11001-01	1	-	27.6	1,989	(654)	(14,072)	(1,818)	(7,442)	-
8	71B	Ranger VIII Locale		402-11001-01	2	17	13.2	631	106	9,253	1,003	1,917	194
9	72A	Manned Orbiter No. 2		303-11001-01	1	-	27.6	1,989	(654)	(14,072)	(1,818)	(7,442)	-
10	72B	Capella M Locale		402-11001-01	2	3	12.5	600	97	846	2,074	2,074	194
11	73A	Manned Orbiter No. 3		303-11001-01	1	-	27.6	1,989	(654)	(14,072)	(1,818)	(7,442)	-
12	73B	Oceanus Procellarum Locale		402-11001-01	2	13	12.3	588	94	9,180	930	1,990	190
13	74B	Photographic Orbiter No. 1		200-11001-01	-	-	-	-	-	(1,060)	(0)	(52)	-
14	74B	Moltke B Locale		402-11001-01	2	26	12.4	596	95	9,431	1,181	1,739	200
15	75B	Hyginus Rille Locale		503-21001-01	2	1	13.0	935	280	7,886	986	6,214	80
16	76A	Grimaldi Locale		503-21001-01	2	21	12.6	910	271	8,615	1,715	5,485	80
18	77A	Copernicus Locale and Path N		503-21001-02	3	29	33.3	2,401	724	13,432	6,502	668	400
19	78A	Path D		503-21002-02	4	-	82.0	5,903	1,787	27,313	15,279	887	500
20	79A	Path G and Path H		503-21002-01	3	-	67.0	4,824	1,372	12,744	1,091	1,356	900
21	79A	Photographic Orbiter No. 2		200-11001-01	-	-	-	-	-	(1,060)	(0)	(52)	-
22	79B	Path C, Path E, and Path F		503-21002-01	3	-	74.0	5,330	1,341	12,600	948	1,500	1,600
23	78B	Explosives Delivery Probe No. 1		100-11011-01	-	-	-	-	-	(6,100)	(5,900)	(0)	-
24	79B	Explosives Delivery Probe No. 2		100-11011-01	-	-	-	-	-	(6,100)	(5,900)	(0)	-
25	78B	Photographic Orbiter No. 3		200-11001-01	-	-	-	-	-	(1,060)	(0)	(52)	-
26	79B	Photographic Orbiter No. 4		200-11001-01	-	-	-	-	-	(1,060)	(0)	(52)	-
27	81B	Path A and Path B		503-31011-01	2	-	103.1	7,422	1,912	26,319	15,035	607	1,800
28	82A	Explosives Delivery Probe No. 3		100-11011-01	-	-	-	-	-	(6,100)	(5,900)	(0)	-
29	82A	Explosives Delivery Probe No. 4		100-11011-01	-	-	-	-	-	(6,100)	(5,900)	(0)	-
30	82A	Photographic Orbiter No. 5		200-11001-01	-	-	-	-	-	(1,060)	(0)	(52)	-
31	82A	Path J		503-31011-01	2	-	65.3	4,702	1,154	25,890	14,667	1,036	1,200
32	82B	Explosives Delivery Probe No. 5		100-11011-01	-	-	-	-	-	(6,100)	(5,900)	(0)	-
33	82B	Photographic Orbiter No. 6		200-11001-01	-	-	-	-	-	(1,060)	(0)	(52)	-
34	82B	Communications Orbiter No. 1		200-11021-01	-	-	-	-	-	(7)	(7)	(7)	-
35	83B	Grimaldi Locale and Path M		406-31011-01	3	21	94.2	13,567	3,832	65,688	22,621	0+	2,000
36	84A	South Pole Locale and Path I		406-31021-01	3	16	177.7	25,583	8,667	52,466	20,909	534	1,000
37	84A	Communications Orbiter No. 2		200-11021-01	-	-	-	-	-	(7)	(7)	(7)	-
38	84B	Path K		503-31011-01	2	-	56.5	4,065	932	26,478	15,307	448	1,200
39	85A	Grimaldi Base		412-31011-01	7	21	661.1	191,837	65,252	182,991	100,318	2,509	240
40	87B	Path L		406-31021-01	3	-	178.5	25,710	8,296	51,864	20,265	1,136	2,100
41	86B	North Pole and Path T		503-31011-01	2	27	22.5	4,893	1,334	26,808	15,583	118	800
42	86A	Supplement to Mission 39		412-31011-02	8	21	-	-	-	-	-	-	-
Total										577,964*	255,186*	30,218*	14,678

*Parenthetical Data Not Included in Sums Nor in Cumulative Surface Performance Calculations.
 +Surplus Expendables were Offloaded to Increase Mass of Other Cargo.

PROGRAM III EQUIPMENT USAGE AND COST SUMMARY

ID No.	Equipment Identification	R&D Start	First/Last Use	Number Procured		Cost Summary (Millions of Dollars)				Total Cost
				Operations	Test & Spares	Nonrecurring		Recurring		
						C of F	Procurement	Operation		
1211-01	<u>LAUNCH VEHICLES</u>									
1212-01	Atlas Agena	-	70A/70A	0	2	.0	.0	12.8	3.0	15.8
1213-01	Atlas - Centaur	-	74B/84A	8	1	.0	.0	203.4	35.1	238.5
1214-01	Saturn IB - Centaur	75B	75B/82B	5	1	64.0	.0	300.0	60.0	424.0
1231-01	Saturn IB	-	75A/81A	0	6	.0	.0	.0	.0	.0
1231-04	Saturn 50,500 kg	67B	71A/80A	28	3	387.0	53.0	3,153.0	567.3	4,160.3
1251-04	Upgraded Saturn V (185 ⁵⁰)	77B	81B/88A	32	4	755.4	228.2	4,227.5	669.6	5,880.7
	SUBTOTAL					1,206.4	281.2	7,896.7	1,335.0	10,719.3
1311-03	<u>FLIGHT SYSTEMS</u>									
1313-02	Command Module LOR - 3 Man	-	71B/74B	8	1	.0	.0	547.3	135.9	683.2
1324-02	Command Module LOR - 4 Man	73A	75B/80A	10	1	62.4	.0	671.7	166.1	900.2
1331-02	Service Module LOR	67B	71A/80A	21	3	42.8	.0	565.7	105.6	714.1
1342-02	Descent Stage LOR	68B	71B/80A	18	2	46.6	.0	366.5	76.0	489.1
1412-03	Personnel Ascent Stage LOR - 3 Man	-	75B/80A	10	1	.0	.0	388.1	99.0	487.1
1421-04	Command Module - Direct - 6 Man	77B	81B/88A	15	2	509.0	.0	1,295.0	253.3	2,057.3
1431-05	Personnel Braking Stage-Direct-6 Man-Cryo	78B	81B/88A	32	4	35.0	12.0	278.9	57.6	383.5
1442-08	Personnel Landing Stage-Direct-6 Man-Cryo	79A	81B/88A	15	2	21.0	.0	168.7	28.9	218.6
1451-03	Logistics Braking & Landing Stage	71B	75B/87B	24	3	420.0	20.0	371.7	62.1	573.8
	Personnel Earth Return Stage-Dir.-6 Man-Cryo	77B	81B/88A	13	2	299.0	12.0	312.1	54.4	477.5
	SUBTOTAL					1,435.8	44.0	4,965.7	1,038.9	7,484.4
2121-01	<u>MISSION EQUIPMENT</u>									
2211-03	Orbit Launched Probe	69A	71A/73A	24	3	57.5	.0	78.4	8.1	144.0
2222-02	Unmanned Orbiter	72A	74B/82B	6	1	75.0	.0	64.2	4.2	143.4
2222-03	Orbiter Rack	69A	71A/73A	3	3	1.0	.0	2.4	.0	3.4
2321-05	Manned Orbiter - 3 Man	-	71A/73A	4	1	117.0	.0	243.2	60.4	303.6
2423-01	Personnel Shelter - 2 Man (ALM)	68A	71B/74B	4	1	117.0	.0	186.3	46.0	349.3
2423-04	Personnel Shelter - 6 Man	73B	83B/87B	5	1	422.0	.0	258.4	34.9	715.2
2434-02	LRV - No Cabin (LSSM)	68B	71B/85A	10	1	55.0	2.0	51.6	5.5	117.1
2511-02	Trailer - Multipurpose	70A	75B/87B	15	2	328.0	.0	202.6	.0	530.6
2711-13	LFV Exploration - 1 Man	75B	78A/87B	11	2	23.5	.0	20.8	.0	44.3
2722-04	LFV Fuel Resupply	73A	75B/87B	13	2	9.2	.0	9.8	.0	19.0
	Nuclear Power Supply - Isotope	-	75B/87B	13	2	.0	.0	.0	.0	.0
	SUBTOTAL					1,149.8	12.0	1,177.3	139.0	2,498.1
3213-02	<u>MAJOR SCIENTIFIC EQUIPMENT</u>									
3222-01	300 Meter Drill with Fuel Cell	74B	78A/87B	8	1	11.3	.0	15.9	.0	27.2
3223-01	Radio Telescope - Mills Cross	80A	83B/83B	1	1	2.0	.0	1.1	.0	3.1
3224-01	15 Meter Parabolic Radio Telescope	81B	85A/85A	1	1	4.1	.0	3.6	.0	7.7
3231-01	Radio Telescope - Mills Cross	79B	85A/85A	1	1	30.0	.0	8.0	1.0	39.0
3231-02	X-Ray Telescope	78B	85A/85A	1	1	38.8	.0	6.2	1.0	46.0
3242-02	X-Ray Telescope - Wide Angle	-	83B/83B	1	1	.0	.0	.0	.0	.0
3242-05	Optical Telescope - 1 Meter	79A	83B/87B	3	1	28.7	.0	22.4	2.0	53.1
3243-01	Optical Telescope - Solar	79B	85A/85A	1	1	122.0	.0	54.4	.0	176.4
	Optical Telescope - 2.5-Meter	78B	85A/85A	1	1	226.8	.0	31.2	1.4	259.4
	SUBTOTAL					463.7	.0	142.8	5.4	611.9
	TOTAL					4,255.7	337.2	14,152.5	2,538.3	21,313.7

PROGRAM III
SCIENTIFIC PROGRAM OPERATIONAL SUMMARY

SURFACE SCIENTIFIC MANHOURS

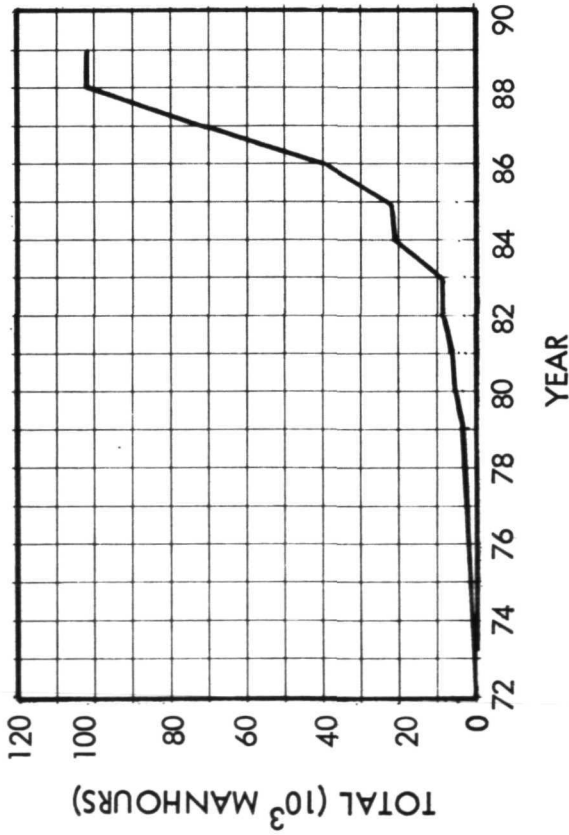

SURFACE SCIENTIFIC EQUIPMENT MASS

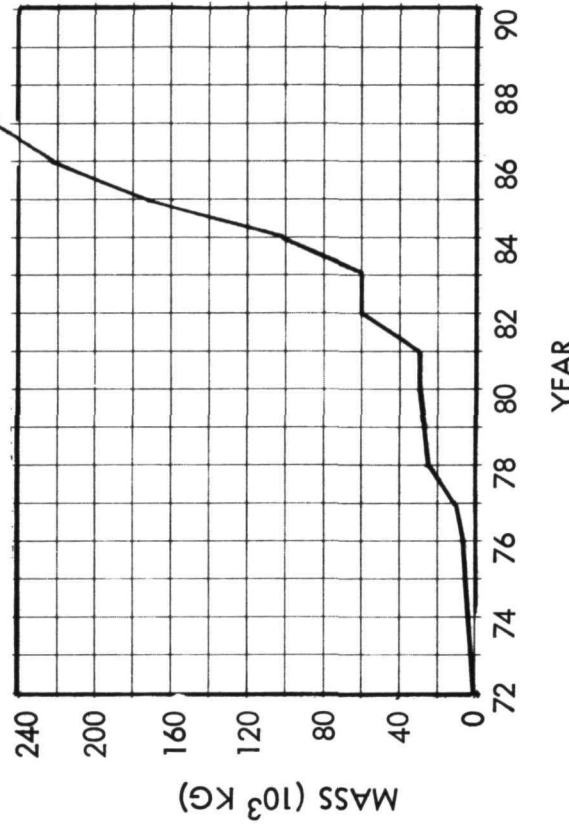

SURFACE SCIENTIFIC EQUIPMENT MASS

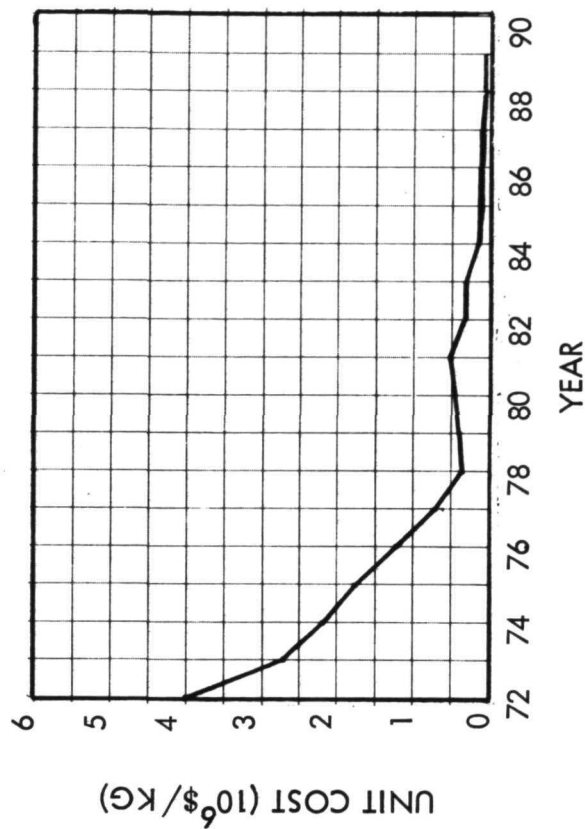

SURFACE SCIENTIFIC MANHOURS

