

UNCLASSIFIED

AD 4 2 2 2 7 4

DEFENSE DOCUMENTATION CENTER

FOR

SCIENTIFIC AND TECHNICAL INFORMATION

CAMERON STATION, ALEXANDRIA, VIRGINIA



UNCLASSIFIED

NOTICE: When government or other drawings, specifications or other data are used for any purpose other than in connection with a definitely related government procurement operation, the U. S. Government thereby incurs no responsibility, nor any obligation whatsoever; and the fact that the Government may have formulated, furnished, or in any way supplied the said drawings, specifications, or other data is not to be regarded by implication or otherwise as in any manner licensing the holder or any other person or corporation, or conveying any rights or permission to manufacture, use or sell any patented invention that may in any way be related thereto.

⑥ ⑤ 192 350

LUNAR SHELTER CONCEPTS

422274

by UNIVERSITY of CINCINNATI
DEPT. OF ARCHITECTURE
and INDUSTRIAL DESIGN

INSTRUCTORS

K.H. MERKEL J. ALEXANDER

CO-ORDINATED & DIRECTED BY
F. FORBES and A. VASILOFF
FLIGHT ACCESSORIES LAB
ASD, USAF

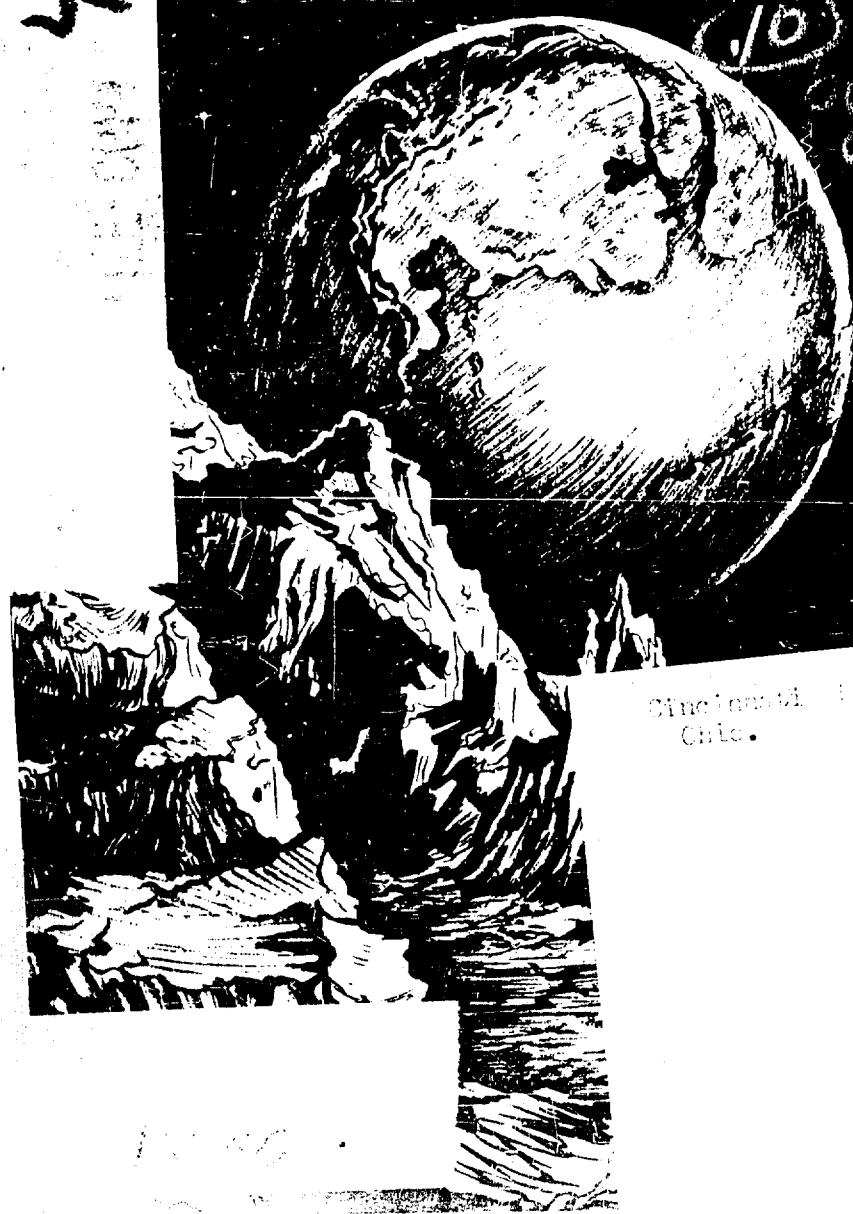

Cincinnati: U. Coll. of Design, Architecture and Art
Chgo. 192 350

[Handwritten signature]

UNIVERSITY OF CINCINNATI
COLLEGE OF DESIGN, ARCHITECTURE, AND ART
CINCINNATI 21, OHIO

November 11, 1963

Defense Documentation Center
Cameron Station
Alexandria, Virginia

Gentlemen:

SUBJECT: Request for photo copies of report.

Enclosed you will find a copy of the report, "Lunar Shelter Concepts", originally printed by the Air Force Aero Propulsion Lab at Wright-Patterson Air Force Base and covering a collaborative design project undertaken by two departments of the College of Design, Architecture, and Art at the University of Cincinnati.

Requests for copies of the report have exceeded our supply and that of the Aero Propulsion Lab. At the Lab's direction, we are forwarding this copy to you with the request that photo copies be made. We will refer future requests for copies to you.

Very truly yours,

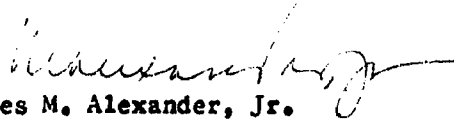

James M. Alexander, Jr.
Professor of Design
Head, Department of Industrial Design

JMA:jpc

Preface

.

The Flight Accessories Laboratory, Aeronautical Systems Division, wishes to extend its sincere appreciation to the Applied Arts College of the University of Cincinnati for their organization of this Lunar Shelter Research Program. Special appreciation is given to Dean E. Pickering, Dean R. Ketchum, Mr. R. Deshon, Mr. K. Merkel, and Mr. J. Alexander who were mainly responsible for the undertaking of this effort. Considering the time interval for this research problem, the results are considered exceptional. It is hoped that the University of Cincinnati and other Universities will initiate other similar studies. The Flight Accessories Laboratory also wishes to extend its sincere appreciation to Aeromedical Laboratory and Flight Dynamics Laboratory for assistance in the organization of the design program requirements.

Further appreciation is expressed by Mr. F. Forbes and Mr. A. Vasiloff to Lt/Col L. Winebrenner, Chief, Flight Accessories Laboratory; Mr. L. Hildebrandt, Technical Director, Flight Accessories Laboratory; Mr. H. Amli, Chief, Support Techniques Branch; Mr. R. Gafvert, Assistant Chief, Support Techniques Branch; Mr. J. Tackis, Chief, Logistics, Maintenance and Support Techniques Section and Mr. C. Martel, Chief, Liquid Propellant and Gas Servicing Techniques Section for their stimulation, interest, and advice in this collaborative effort.

DDC
RECEIVED
NOV 14 1963
RECEIVED
TISIA B

Table of Contents

	Page
Preface	1
Introduction.	1
Lunar Shelter Program	4
Problem 1	9
Problem 2	35
Problem 3	48
Problem 4	62
Problem 5	80
Problem 6	105
Problem 7	140
Problem 8	159
Problem 9	173
Problem 10.	195
Problem 11.	207
Problem 12.	216
Problem 13.	228

INTRODUCTION

Background: In January 1962 contact was initially made between Flight Accessories Laboratory personnel and the officials of the University of Cincinnati, College of Applied Arts, to discuss the feasibility of the University undertaking an unfunded student design study of a Lunar Shelter. It was agreed that such a study, although not an official Air Force Program, would mutually benefit the University and the Air Force. The Flight Accessories Laboratory agreed to submit a list of Lunar Shelter requirements and assumptions to the University. This program, shown in the following section, created guide lines for the student. This problem was officially assigned to the fourth year architects and the third and fourth year industrial design students of the University for a period of seven weeks. Approximately sixty students were divided into thirteen teams to participate in this design program. The students utilized the first week doing a literature survey. The remaining six weeks were spent on the solution of the problem and the final presentation. The personnel of the Flight Accessories Laboratory made three visits to the University during the problem's assignment, two of which were for guidance, and the final visit was for the final critique and grading of the student teams.

The students' final solution to the problem is represented in this report by both graphic and written material. As some of the student teams presented their final solution with the use of 35 mm slides and models, it was necessary to eliminate some of the slides to keep this report to a minimum volume.

Purpose: The main intent of this report is to disseminate the thirteen solutions of the Lunar Shelter design problem; however, the solutions contained in this report do not necessarily reflect the technical position of the Air Force. The reports are published as presented by the students, and contain no comments or critiques by the U. S. Air Force.

Scope: The solutions to the lunar shelter design problem contained in this manuscript are limited to a general design philosophy, general floor plan arrangements and general details. Since the designs were done by upper class students in the Department of Architecture and Industrial Design, the problem was initiated and completed in a period of seven consecutive weeks, and it was impossible for the solutions to be very detailed.

Assumptions: Several assumptions were made for the students. These were in the areas of requirements for radiation shielding, lunar environment, and power supply. It was assumed that ten feet of lunar dust would be adequate for shielding purposes. It should be realized that this figure is an average of many sources ranging from a few feet to a hundred feet of lunar dust. Further, the students were given an option to use other materials using a simplified approach. The students were also given a wide choice of structural techniques to use, such as airmat, expandable honeycomb, and foaming techniques, although it is recognized that some of these techniques are at this time beyond the state of the art. It was felt, however, that some of these techniques would be feasible by the 1970 time period. The environment of the moon was taken from many sources, but again it has been standardized for the benefit of the student. A solar collector was chosen as a power supply, but it is realized that an atomic reactor could also

be utilized in actual practice. During the lunar night the power would be supplied by either battery or an Auxiliary Power Unit (APU). These assumptions were made to allow the student to spend the majority of time on actual design rather than deciding on power supply, radiation protection required, etc. The actual program guidance and assumptions as given to the student appears in the next section.

Lunar Shelter Program

1. GENERAL:

Current missile and space emphasis indicate that successful landings on the moon will come within the next 5 - 10 year period. When man is landed on the moon, facilities must be provided for the proper shelter of personnel and maintenance of equipment. The designing of a shelter to meet the harsh environment of the moon presents many problems. Not only must the shelter provide protection against vacuum, radiation, meteoroids, temperature extremes, and other conditions, but the ability of the personnel to fabricate and erect the shelter on the moon in a minimum of time must be considered.

The technical feasibility of a lunar shelter has been established by previous Air Force studies. These shelters will complement a manned lunar base, which is indicated will be established in the 1970 time period. Although the moon's environmental conditions are not thoroughly known, enough data is available to allow a preliminary concept to be outlined. As most knowledge is gained about the moon's environment, a more direct type of permanent lunar base could be designed. However, since clear cut solutions to problems now do not exist, and since the time period of investigation is critical, the design concepts ~~that~~ must be utilized will be those that can be investigated and adapted in a minimum of time.

A thick walled concrete and steel structure would be ideal for providing a shelter on the moon. However, weight limitations on the transportation of such articles, and the hazardous, unsuitable environment for construction, make it impractical to consider this type of structure at the present time. Further, any shelter and/or equipment must be packaged in a manner that will be compatible with a booster rocket. Assembly or construction of complicated facilities are unfeasible in a vacuum. Present pressurized space suits make complicated space assemblies unfeasible. Probably after the first base is set up underground facilities would be constructed, however, there is a specific requirement for a shelter that can be transported to the moon or extraterrestrial bodies in either prefabricated modules and/or expandable structural modules.

The architects and industrial designers of today should become familiar with requirements of space architecture or scientists and engineers will be the architects and designers of the future.

2. LUNAR ENVIRONMENT ASSUMPTIONS:

- a. Atmosphere, for all practical purposes, consider it to be a hard vacuum.
- b. Temperature ranges -250°F in Lunar shadow, +225°F in sun light.
- c. Lunar day 14 days long, lunar night 14 days.
- d. Surface conditions, most areas of the moon are covered with at least six inches of fine dust particles.

- e. Terrain, mountains, plains and craters.
- r. Seismic effects, not critical.
- g. Lunar surface material is not a radiological hazard.
- h. Water, although there may be ice deposits. It is assumed that there is no water on or below the surface of the moon.
- i. Radiation protection. It is assumed that ten feet of lunar dust will protect the crew and equipment from solar and cosmic radiation.
- j. Gravity. One-sixth that of earth.
- k. Moon personnel capable of working outside in space suit, but time must be held to minimum.

3. SHELTER REQUIREMENTS:

- a. Crew, nine men. (3 working, 3 off duty, 3 sleeping)
- b. Thirty day mission.
- c. 243 cubic feet of refrigeration equipment and food storage required. 50 cubic feet of the 243 is food storage.
- d. Water. 250 gallon for drinking, cooking, etc., 100 gallon for non-potable systems.
- e. Power supply 10 KW (Provide by a solar collector). Solar collector is 40 feet in diameter parabolic reflector. See sketch for schematic of equipment necessary for operation.

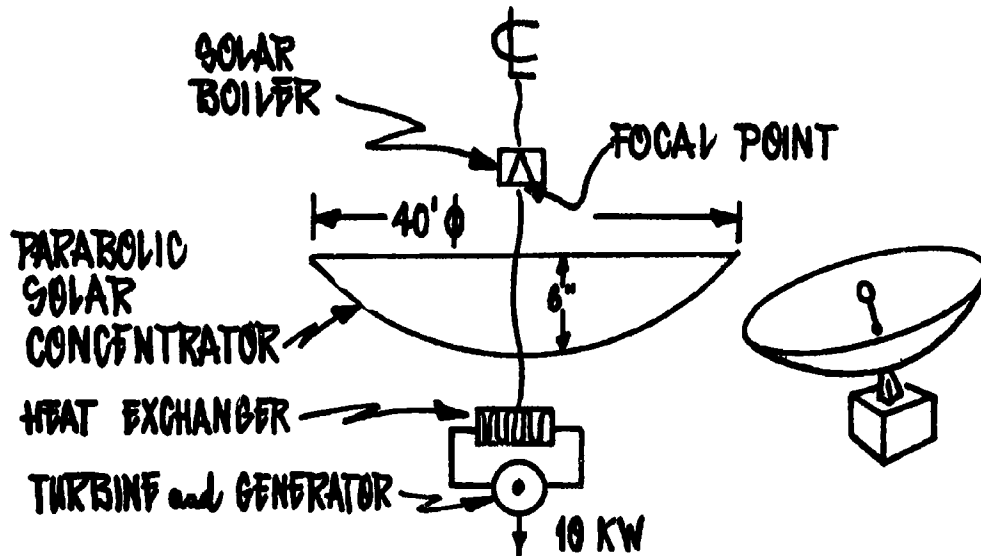

- f. Sleeping area for three (3) men. 2 Emergency bunks for sickness, etc.
- g. Recreation area or areas for 3-4 men.
- h. Bathroom facilities, shower, lavatory, and water closet.
- i. Work area or areas-Communications, Biological Lab., Lunar mineral analysis Lab., Reconnaissance Lab., and Multi-purpose Lab. area.
- j. Noise reduction, noise producing equipment should be isolated and/or accoustical treatment integrated into the design to eliminate noises.

- k. Careful consideration should be given to color selection.
- l. Lighting requirements 40 foot candles.
- m. An airlock or airlocks should be an integral part of the design.
- n. All door openings or windows will have large radius corners.
- o. Atmosphere 10 psia.
- p. Environmental Control: air conditioners, dehumidifiers, odor filters.
- q. Temperature control techniques are as follows:

Case 1. If shelter is covered with Lunar dust, etc. place radiators away from shelter in a permanent shadow area to radiate excess heat and place black body in sun light area for thermal absorption. However, for this case little if any thermal absorption is required.

Case 2. If shelter is not covered, all surfaces facing the sun would have glossy white type of coating, while surface facing lunar terrain would have a polished gold or aluminum type coating. This would need to be accomplished by movable lens because the sun would move with respect to the shelter. There would be several black bodies covered by venetian type blinds located on the dark and light side of the shelter for the purposes of absorbing or radiating thermal energy.

Case 3. If shelter not covered, coat entire exterior of structure with polished aluminum and locate black bodies as in Case 2.

- r. Shelter and equipment should be in a launch package of 14 feet diameter by 35 feet long.
- s. Shelter and equipment not to weigh more than 25,000 lbs.
- t. Shelter should be easily erected and will be erected during lunar night. (Equal to full moon night on earth)
- u. Shelter should be easily expanded by adding other modules.
- v. Possible methods of protecting a crew from radiation are as follows:

Case 1. Cover the entire surface with ten feet of lunar dust.

Case 2. Design structure as a double wall container and fill space with ten feet of lunar dust or equivalent.

Case 3. Design a double wall structure with possibly two feet of lunar dust between walls and design into the structure a storm cellar in the center with an eight foot wall of lunar dust or equivalent.

Case 4. Other materials such as water, plastic foam, steel, lead, etc. may be used in place of lunar dust. The thickness of these materials varies inversely as density of lunar dust (100 lb./cu. ft.) over density of desired radiation material. Example for water density (62.5 lb./cu. ft. $100/62.5 = x/10$, where x equal number of feet of water required).

- w. Ultra Violet radiation can be stopped by a thin layer of metallic foil.

4. CURRENT SHELTER CONCEPT:

- a. Prefabricated Module. The concept is based on the use of prefabricated cylindrical tanks boosted to the moon. These tanks would be part of the lunar booster's final stage. The advantage of this concept is that current construction techniques can be employed, that the launch package is compatible with the booster and that the life support equipment is already inside the module. The main disadvantage is that assembly of the individual modules must still be accomplished in a lunar environment.
- b. Inflatable-Goodyear Aircraft Co. has developed an expandable structure called "Airmat." This concept is based on a pressurized envelope that will retain its shape by internal pressure. Shape other than circular can be maintained by using light weight cross hairs between the two skins. The main disadvantage of this approach is that puncture results in a structural failure.
- c. Foamed in Place Structures. Here a light weight balloon structure is inflated as a form. Then polyurethane foam is allowed to foam over this form. After the foam is hardened, the structure is self-supporting without internal pressure. The main disadvantage of this concept is that it will weigh about 5-6 times as much as inflatable concepts.
- d. Expandable Honeycomb. This is based on fabricating the structure from a flexible honeycomb core and outer skins. After arrival on the moon, the package is inflated and rigidized by plasticizer boil off, ultra violet cross linking or vaporized catalysis. This concept would weigh about 1.5 as much as inflatable concepts, but would not require internal air pressure for structural integrity.
- e. Unfurlable. These concepts are based on unfolding links and/or telescoping links. These concepts would weigh about 2-3 times as much as inflatable concepts. The main disadvantages are mechanical problems in joints and high weight penalty.

5. ASSUMPTIONS:

- a. Lunar dust or rubble exists to depth of 6 inches at shelter site, and the site area is approximately level.
- b. A manned controlled lunar traversing device, capable of moving rubble and having manipulator techniques, shall be available at time of shelter landing.

6. DESIGN SOLUTIONS INCLUDE:

- a. Floor plan or plans.
- b. Cross Section or Sections.
- c. One exterior perspective (color)
- d. Two interior perspectives (color)
- e. Elevations
- f. Perspectives, plans, etc. of interior furnishings (kitchen console, furniture, etc.) (color)

- g. Model(s) optional
 - h. Drawings of structure, equipment, etc., in packaged condition, assembly or exploded diagrams, etc., as necessary to explain concept adequately.
 - i. Two-Three typed pages describing concept as per format issued by instructor.
- 7. RESEARCH: as assigned by instructor
 - 8. PRESENTATION OF RESEARCH DUE: 1 p.m., June 25, 1962
 - 9. PRESENTATION OF DESIGN SOLUTIONS DUE: 1 p.m., July 30, 1962

LUNAR SHELTER CONCEPTS

BY:

Dennis Scott Malone Arch., '64

James Daniel Spinnenweber Arch., '64

Howard Edwin Fischer Ind. Des. '63

David Ralph Moehring Ind. Des. '64

DESIGN PHILOSOPHY

The concept of this team is based on four basic factors: first, the structure should arrive on the moon in as fully a completed stage as possible; second, whatever erection techniques required on the lunar surface should be as simple as possible; third, the shelter as an entity should function as a precision machine with a minimum of human attendance; fourth, the structural capabilities of the transporting cylinder should be utilized to their fullest.

Therefore, this concept involves a basically completed shelter before it actually lands on the moon. The mechanics of transforming the cylinder into working and living space are simple and can be accomplished in a "shirt-sleeve" environment.

Very little time and effort are involved in these processes, thus enabling the crew to proceed with their various tasks soon after arrival.

PACKAGE & ERECTION TECHNIQUES

Due to the relatively short time involved and the adverse working conditions, a system as fully automatic and efficient as possible is desirable. The process of transforming a 14' x 35' cylinder fully packed with equipment into a working-living space is very simple. The bulk of static equipment requiring no supervision (storage facilities, etc.) is located in

movable "pods" within the transporting cylinder.

When the shelter is on the lunar surface, the pods are moved to the exterior of the shell, thus opening the interior for working and living space. The pods are automatically actuated, pressurized and tested before the crew actually arrives. In case of malfunction or meteorite hit, the "pods" can be easily withdrawn into the shell for emergency repairs.

The bottom pods, extending to 16 feet each, will serve as a 3-point stabilizer for final leveling of the shelter. Enclosed within the leveling pods are emergency supplies with which the crew will be able to "sit out" solar flares, meteorite bombardments, and other similar crises.

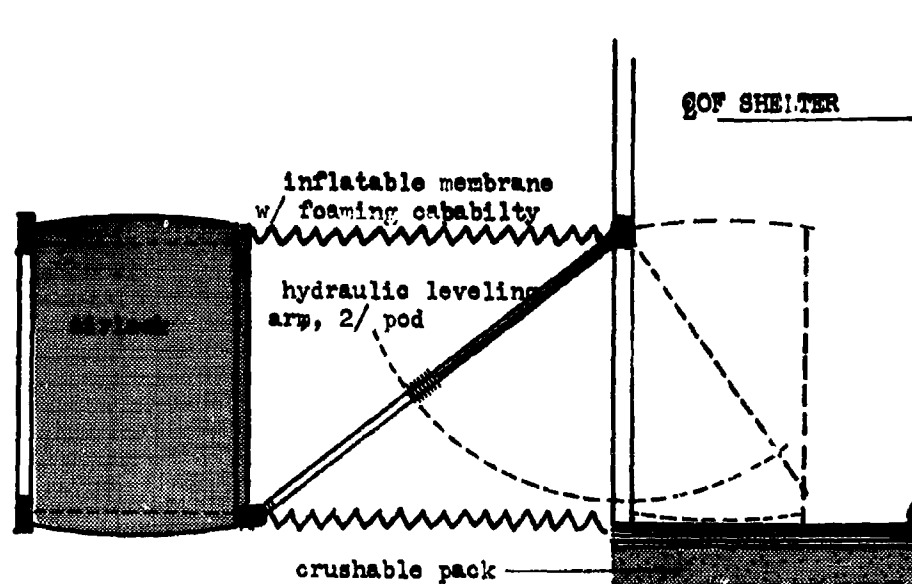

DETAIL OF 3 STABILIZER AT BASE OF SHELTER

STRUCTURES AND MATERIALS

The construction of the shelter walls shall be double wall with honeycomb between. The thicker walls on the outside will furnish protection from meteorites. The honeycomb will provide insulation both thermally and acoustically. The thinner walls on the inside form the primary pressure shell. These three layers, in conjunction with various masses of equipment around the perimeter, are to supply adequate protection from ordinary radiation.

Equipment housed within the "pods" will be enclosed in an inflatable structure with the capability of being rigid and providing thermal insulation.

Floors will be aluminum plate, sandwich honeycomb construction. Ceilings will be luminescent panels and will provide 40 footcandles.

Interior walls are to be truss-like in character with access panels to equipment and storage units. This will provide lateral stability to the whole structure. Communication and observation domes will be an inflatable, transparent, polarized material.

ENVIRONMENTAL PROTECTION

Basically the shelter is enclosed within the cylindrical package. The shelter stands in a vertical position and

is divided into five levels. The entire cylindrical shell is double wall construction with insulation between, providing for protection from extreme heat and cold and for protection from meteorites.

Each level and equipment pod is independent of the others at all times ~~except~~during passage from one level to another. This allows repairs to be made in one area without disrupting activities in another area. Airlocks and decontamination chamber is located in the bottom level to isolate the remainder of the shelter from noisy and possibly hazardous radiological conditions. Protection from solar flare radiation is provided in two lunar-dust covered "pods" at the surface level. Stored within these are emergency water, food and medical supplies.

INTERIOR FURNISHINGS AND EQUIPMENT INTEGRATION

Sleeping facilities consist of nylon webbing mounted between two horizontal bars which unroll from a fixed end located in each "pod" on the sleeping level. These can be rolled up and the area utilized for changing clothes or hygienic activities.

Tables and work surfaces fold down from walls, exposing various storage facilities and equipment related to each area. When closed they provide a smooth wall surface. All equipment is fully integrated into the walls of the shelter or within the pods. Hence, nothing will need to be moved about by the crew.

Chairs are to be foamed in place over wire mesh frame preformed to the contour of the chair. Cushions will be foam rubber. Color selections on all equipment is discussed in the plan analyses.

STATISTICAL INFORMATION

Launch package	5390 cu. ft.
Shelter expanded and erected	10568 cu. ft.
Storage	
Electronic & communications equipment	280 cu. ft.
Heat exchanger and food storage	140 cu. ft.
Refrigeration and food storage	243 cu. ft.
Non-potable water and waste disposal	210 cu. ft.
Odor filters and air-conditioning	150 cu. ft.
Exercising equipment	22 cu. ft.
Biological lab equipment	210 cu. ft.
Mineral analysis lab equipment	210 cu. ft.
Multi-purpose lab equipment	210 cu. ft.
Batteries	210 cu. ft.
Oxygen and water storage	210 cu. ft.
Oxygen and water storage	210 cu. ft.
Mechanical core	430 cu. ft.
Storm cellar and emergency equipment	350 cu. ft.
Exploration equipment and space suit	319 cu. ft.
Storage	
Misc. other fixed equipment	870 cu. ft.
	4274 cu. ft.
Working and living area	6294 cu. ft.
Average ceiling height of 6.85'	918 sq. ft.
Area per crew member	102 sq. ft.

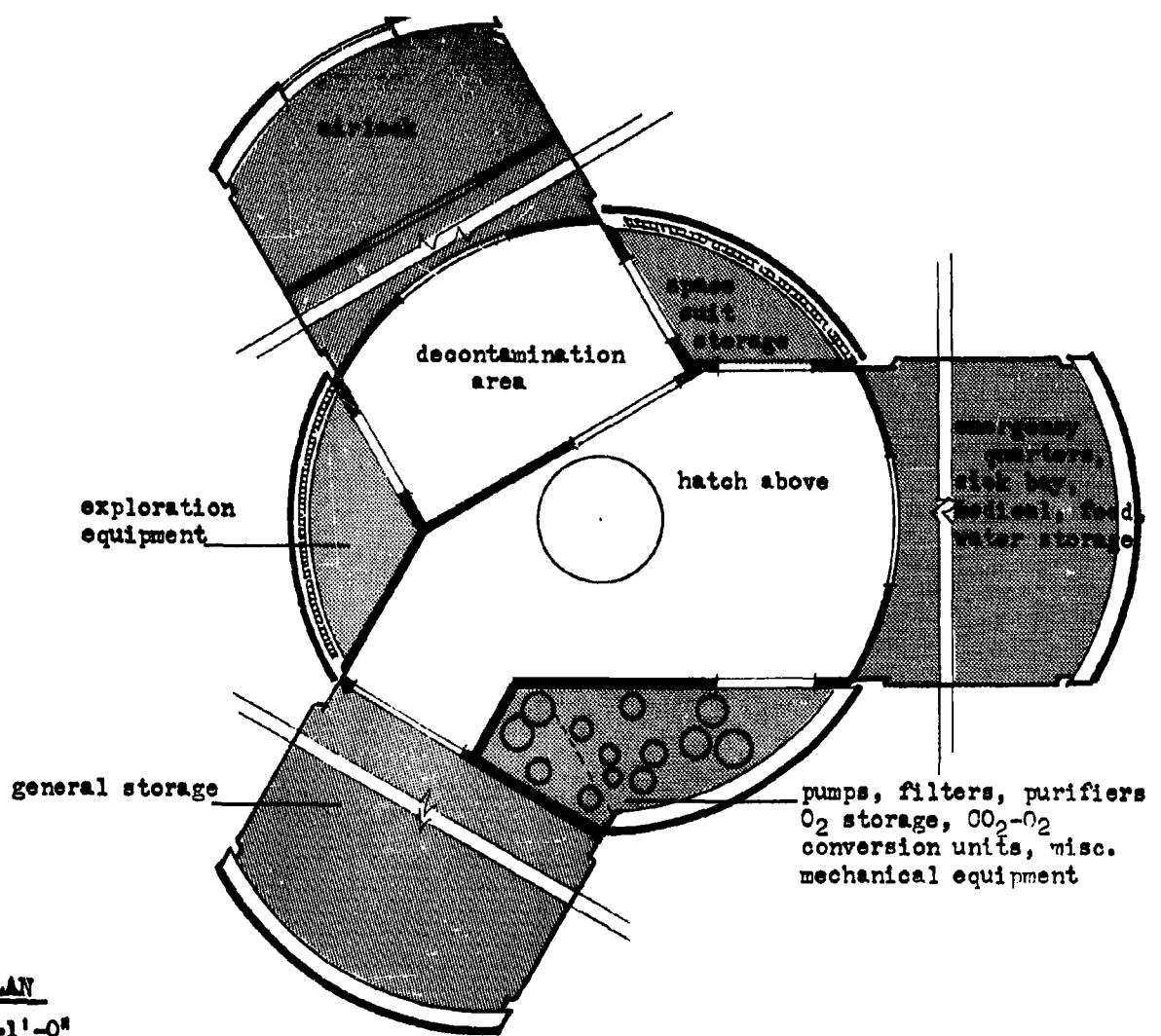

SERVICE LEVEL 1

This the lowest level, when erected will contain three basic elements: air-locks, storm cellars, and miscellaneous heavy mechanical equipment. Adjacent to the air-locks are provided decontamination facilities as well as exploration equipment storage and hot materials lift to the analysis laboratories above,

The storm cellars will contain emergency food, water and survival equipment which will be used in time of excess solar radiation, and similar crises. This area is also to be the sick bay as any injured men would have to be moved to this area.

The colors used are dull gold and yellow-tan. These colors were selected to provide a warm, receptive atmosphere as opposed to the desolate barrenness of the lunar surface.

LABORATORY LEVEL 2

On this level are located the bulk of laboratory and analysis equipment. It is located immediately above the air-lock level. This allows efficient access from lab to lunar surface. Rock samples, etc., can be easily transported to the lab without disturbing other work areas. In conjunction with this function, a shielded lift for heavy and/or radiologically hazardous materials is provided.

Electronic and chemical testing units are within the pods and in the perimeter storage units of the snell. Fold-down work surfaces are employed on this level also, making possible a versatility of work space.

Dark olive green and pale gray-green are the colors used on this floor to minimize eyestrain and provide a non-offensive background for concentrated work.

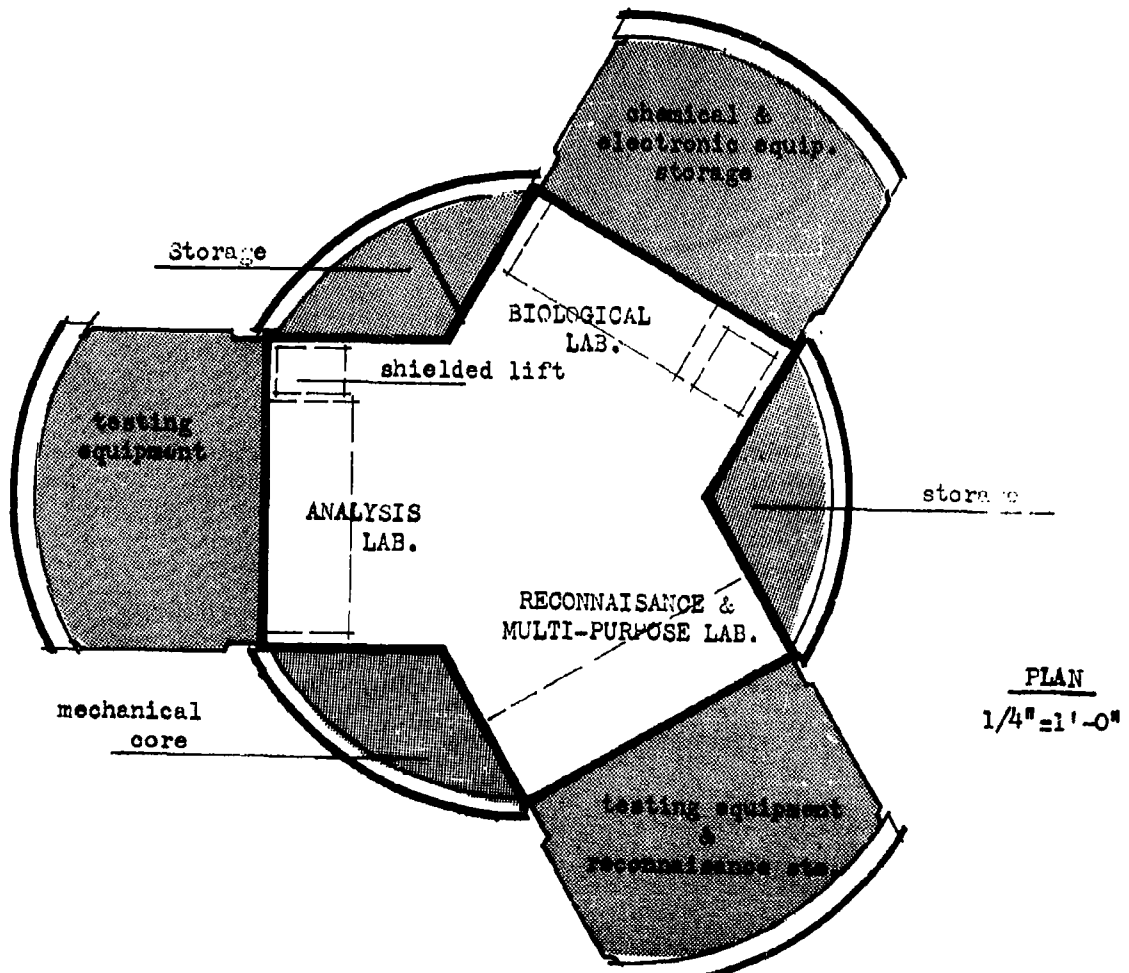

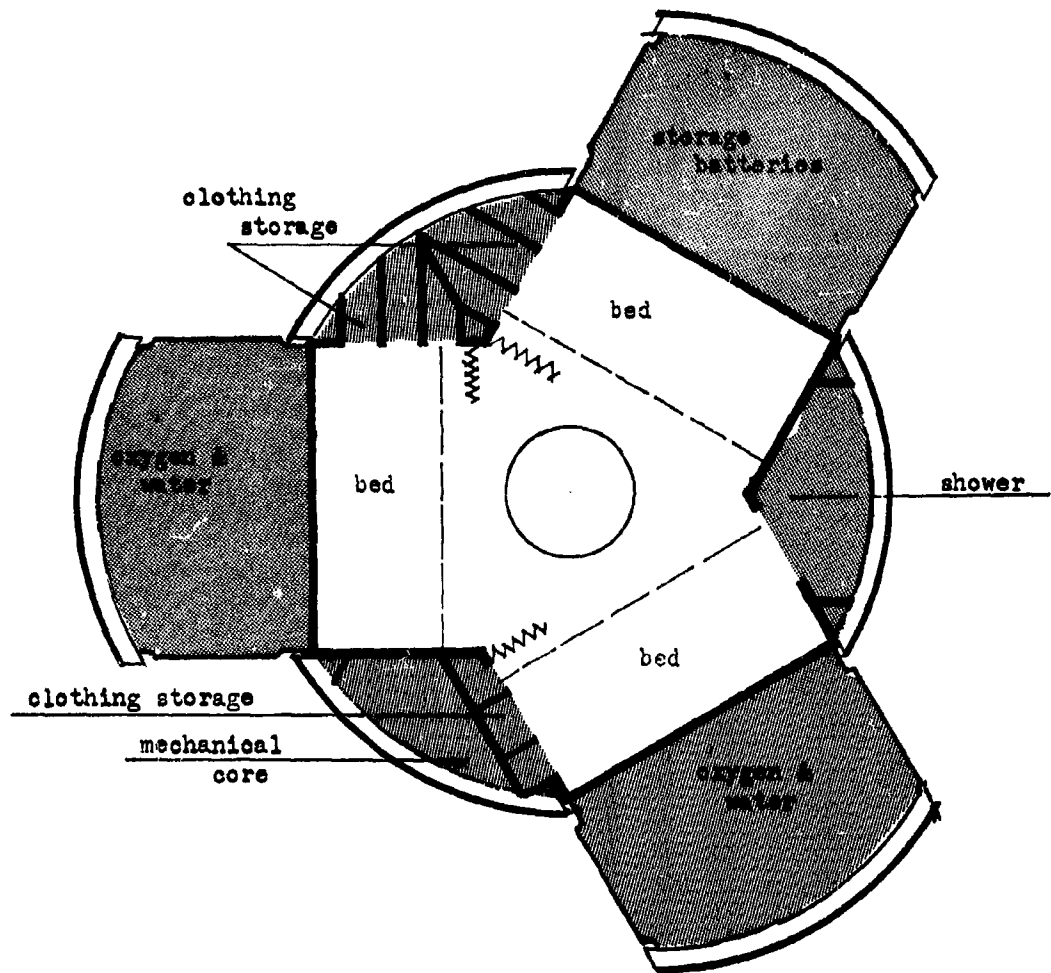

PLAN
1/4"=1'-0"

SLEEPING LEVEL 3

On this level are located the facilities for sleeping and personal hygiene.

The three smaller spaces within the whole area provide a relative degree of privacy for each of the three men occupying this area at any one time. Privacy is further accomplished by a folding screen which shields out stray light, sound and other minor annoyances.

Included in each "berth" are storage facilities for each of the nine men. Also included is a fingertip control panel for individual temperature control, lighting levels, etc. Provided here also is storage space for personal items, such as books, pictures and souvenirs.

The colors in this area should be restful and conducive to sleep. Hence the selection of dark gray-blue for quietness and dulled turquoise to provide some degree of warmth.

EATING AND RECREATION LEVEL 4

This level furnishes space for four off-duty activities: food preparation, eating, exercising and recreation.

The activities of eating and recreation are centered around a "pull-down" table mounted in the wall. Also in this area is a television monitor for recreation viewing, and a toilet and lavatory.

This area includes facilities for exercising and removing tensions of the day-to-day grind.

Food storage and facilities necessary for preparation of same are on this level. Work surfaces of the "pull down" are employed here also.

Warm, gay colors are desirable as a psychological morale booster. Therefore the colors of medium yellow-gold and orange were selected.

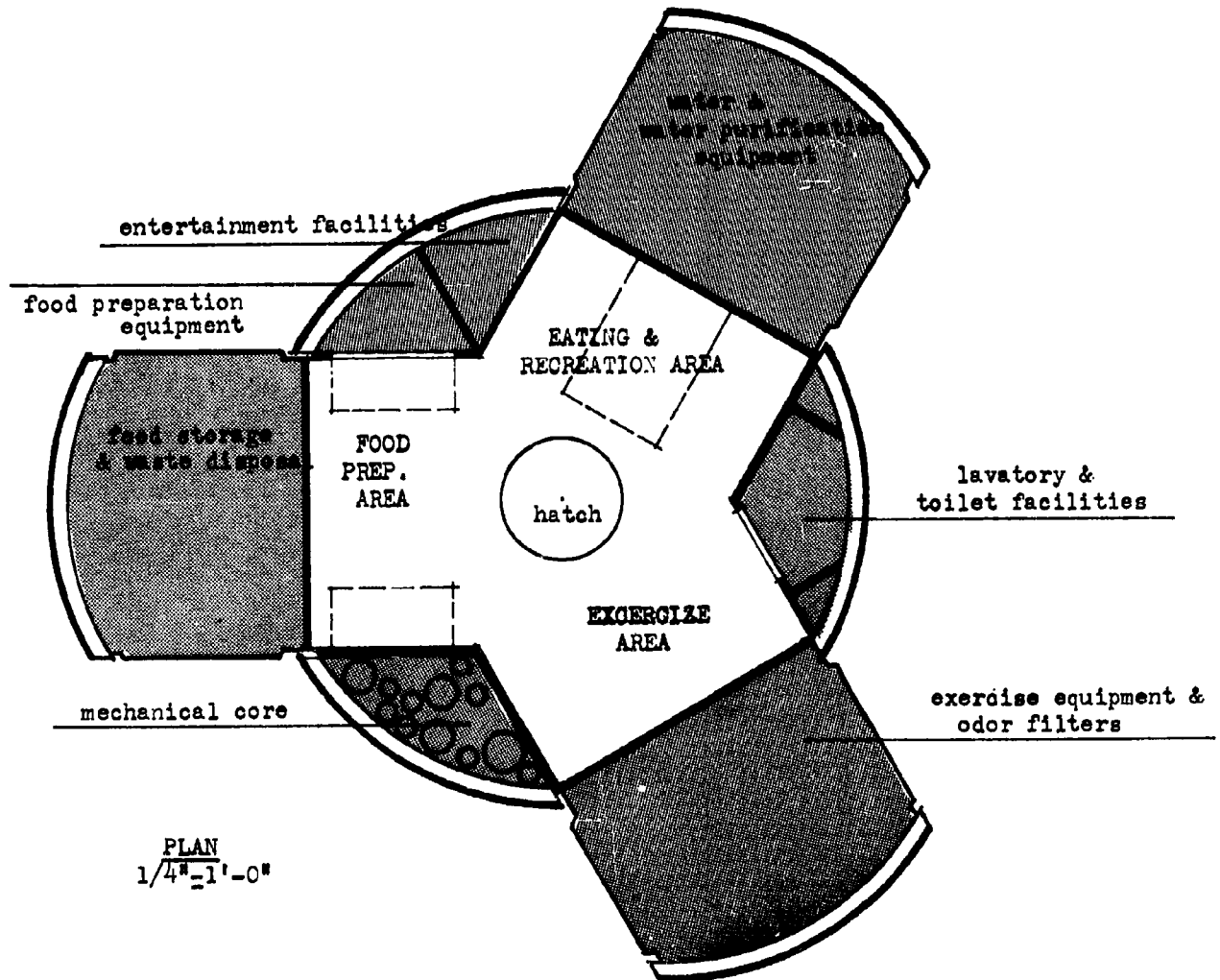

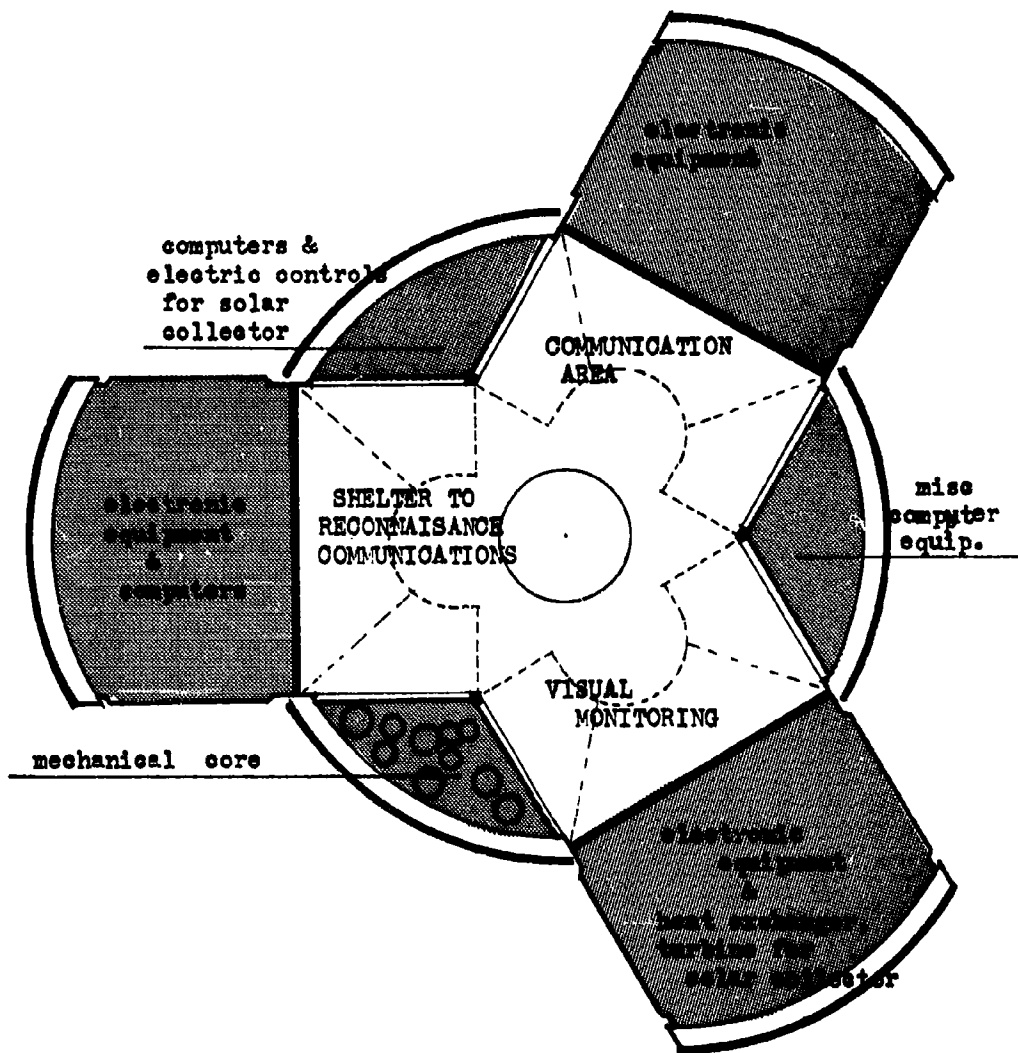

COMMUNICATIONS AND OBSERVATION LEVEL 5

This level being located in the uppermost section of the shelter will provide for all communications and electronic operations. It will also provide for limited observation via inflatable, polarized "bubbles" and telescoping seats. Three stations are provided; thus duties of a monotonous nature can be easily exchanged.

Controls and operating mechanisms for the solar collector mounted immediately above the communications and observation level are located in this area. The heat exchanger and turbine associated with the solar collector are located in one of the pods.

Dark, non-reflective colors are most suited to monitoring electronic equipment; thus the selection of flat black and dark, olive green was made.

THEORETICAL ADVANTAGES OF THIS CONCEPT

1. Elimination of time-consuming and complicated assembly of shelter.
2. Automatic expansion, pressurization and testing of shelter prior to occupancy by crew.
3. Automatic and efficient leveling procedure.
4. Complete segregation between area, each acting as an air-tight compartment.
5. Complete utilization of transporting package.
6. Minimum site preparation.
7. No excavation necessary.
8. Readily adaptable for future expansion of up to a 54-man expedition.
9. Easily contracted and moved to another site.
10. Relatively easy effecting of emergency repairs.

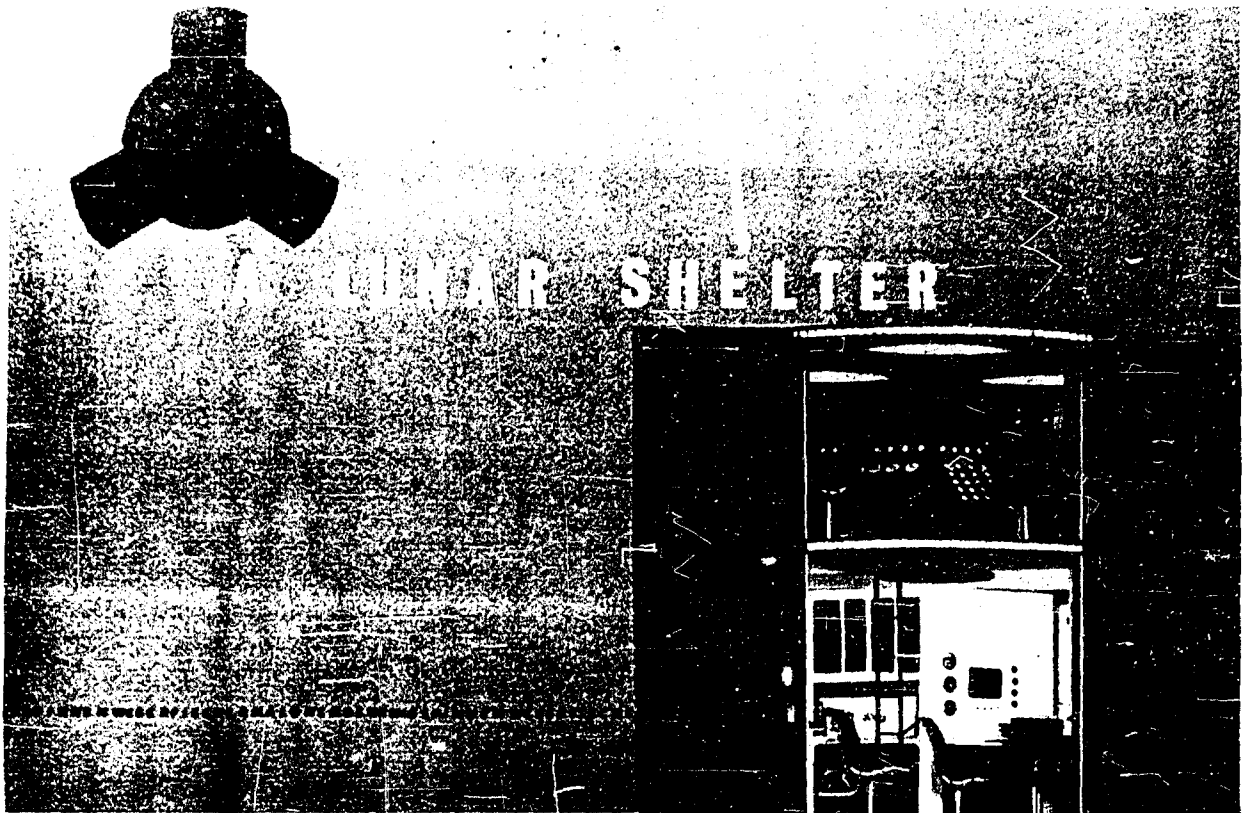

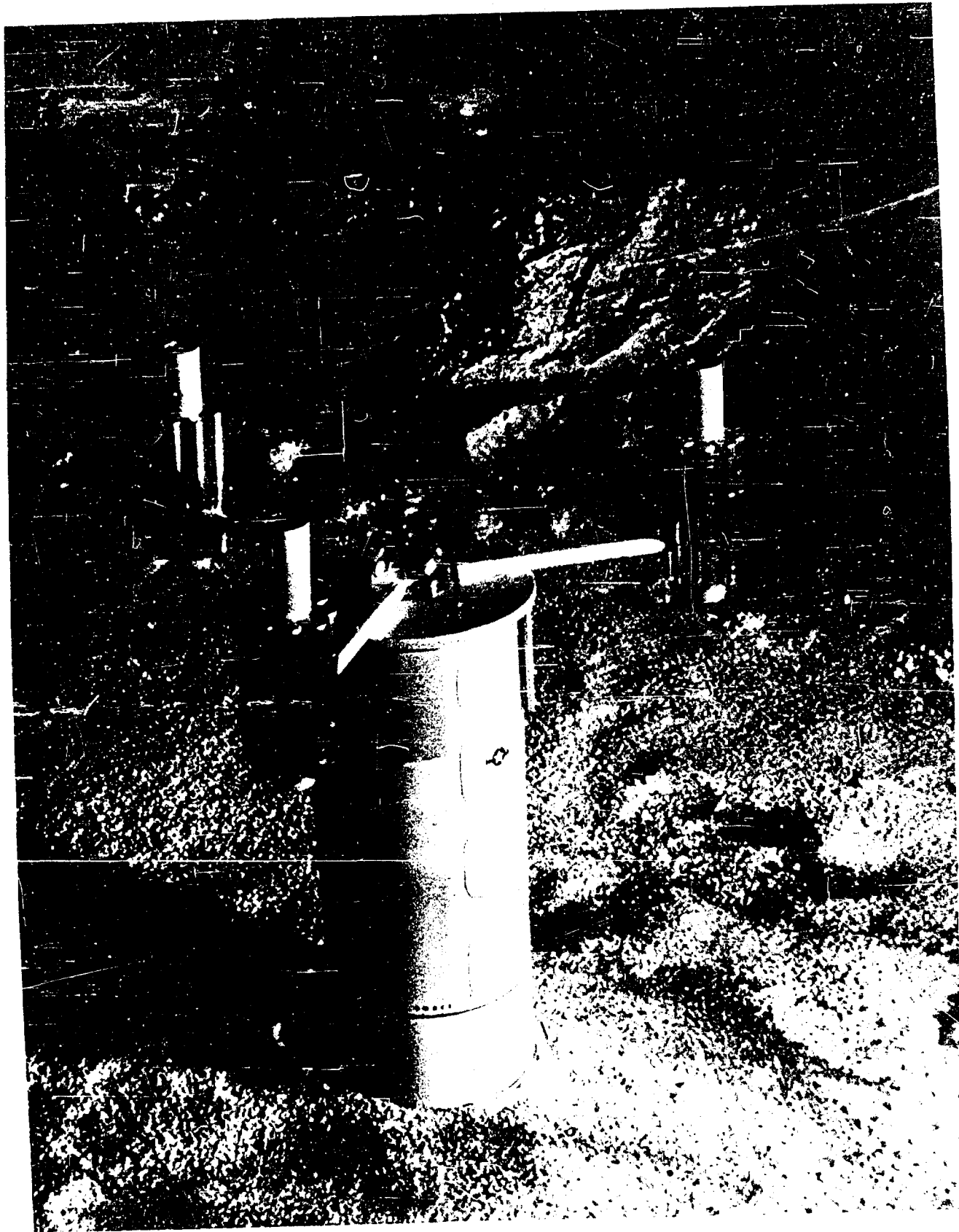

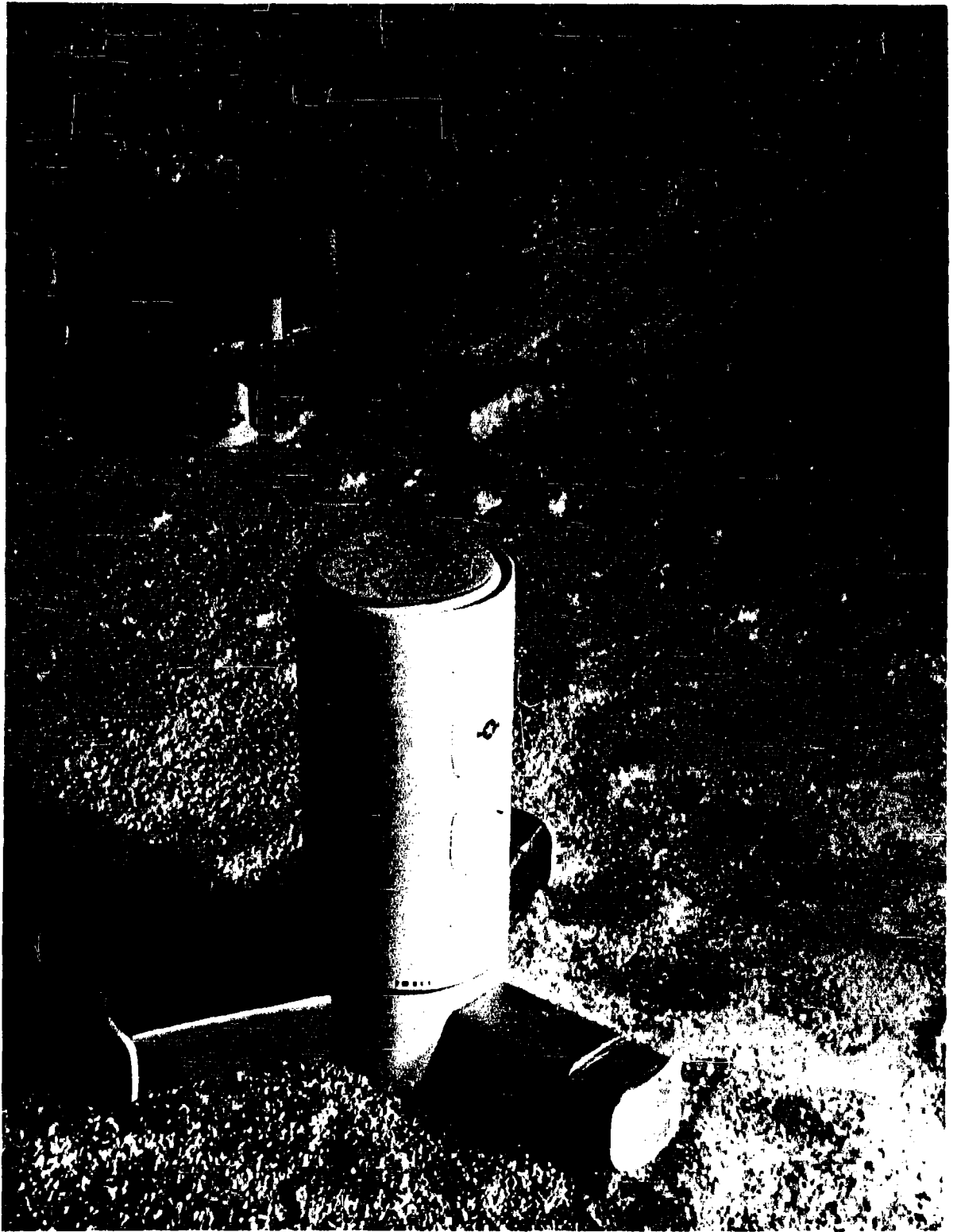

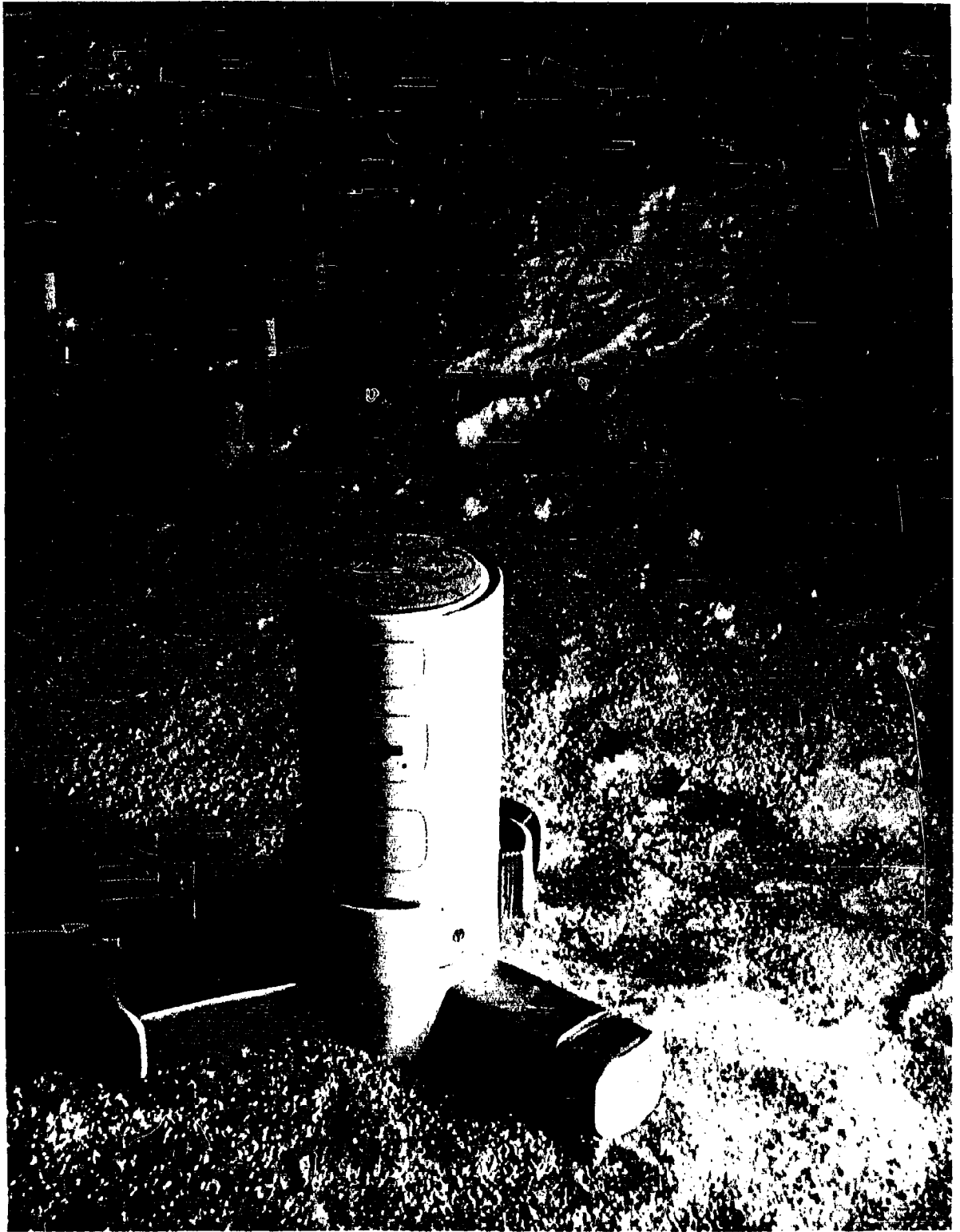

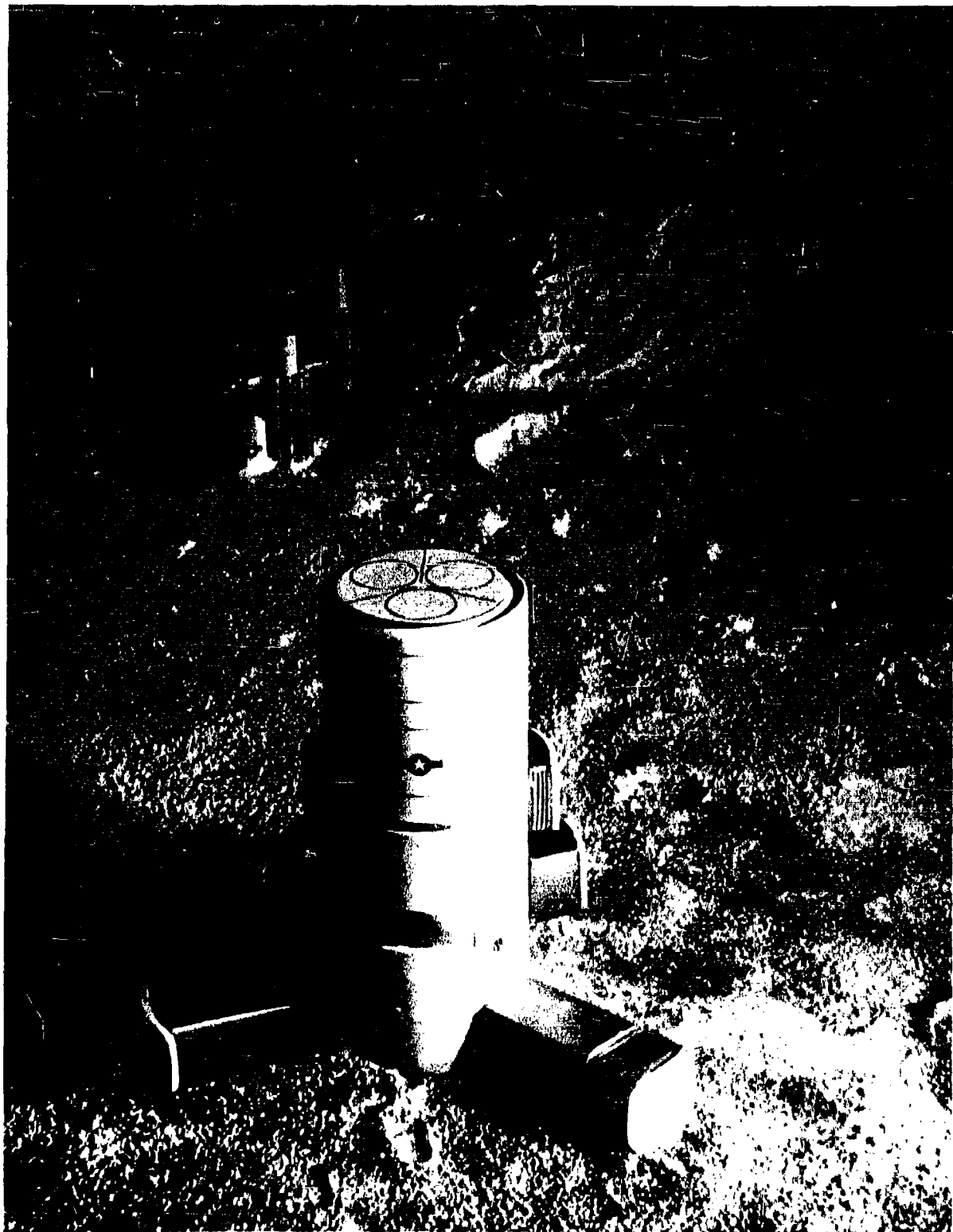

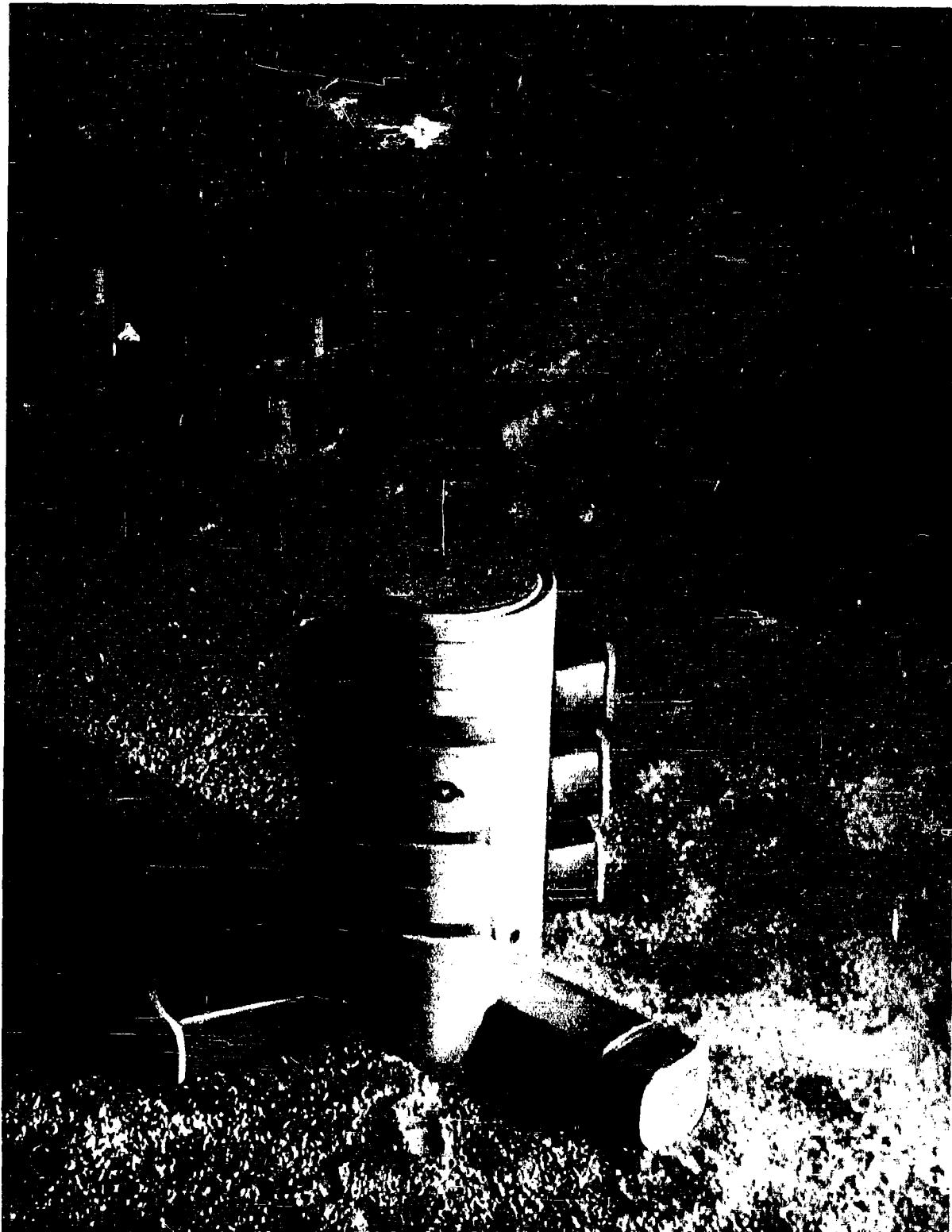

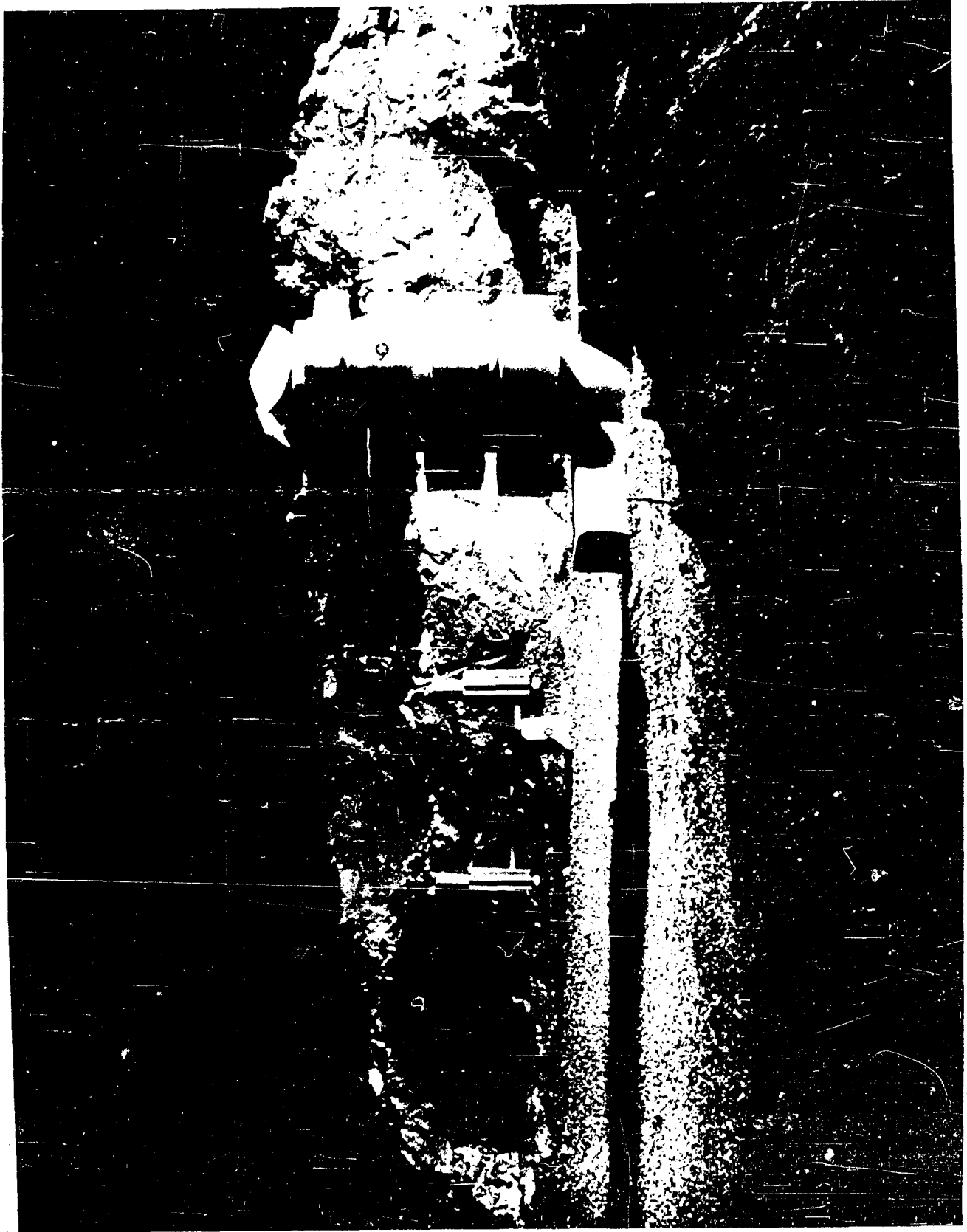

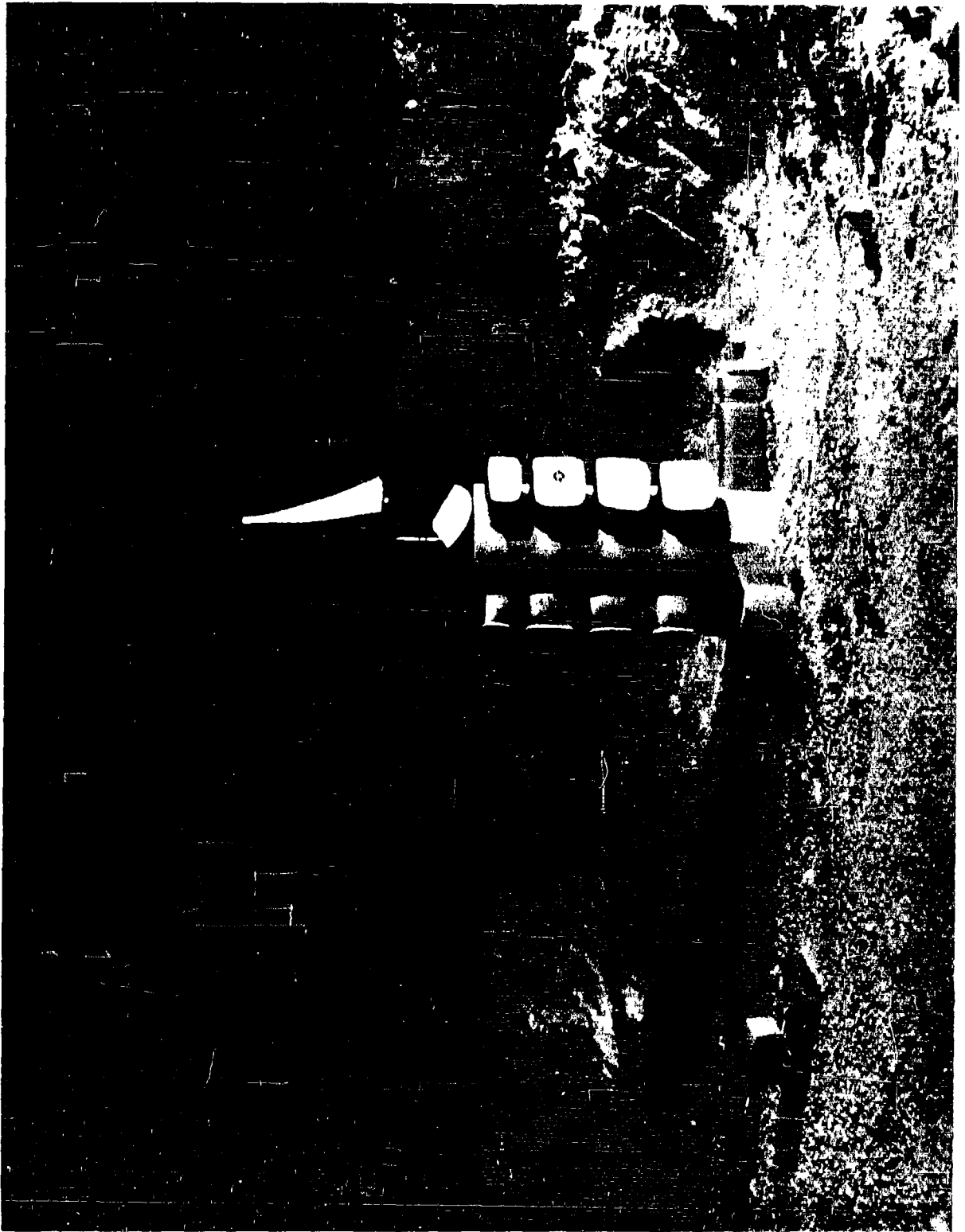

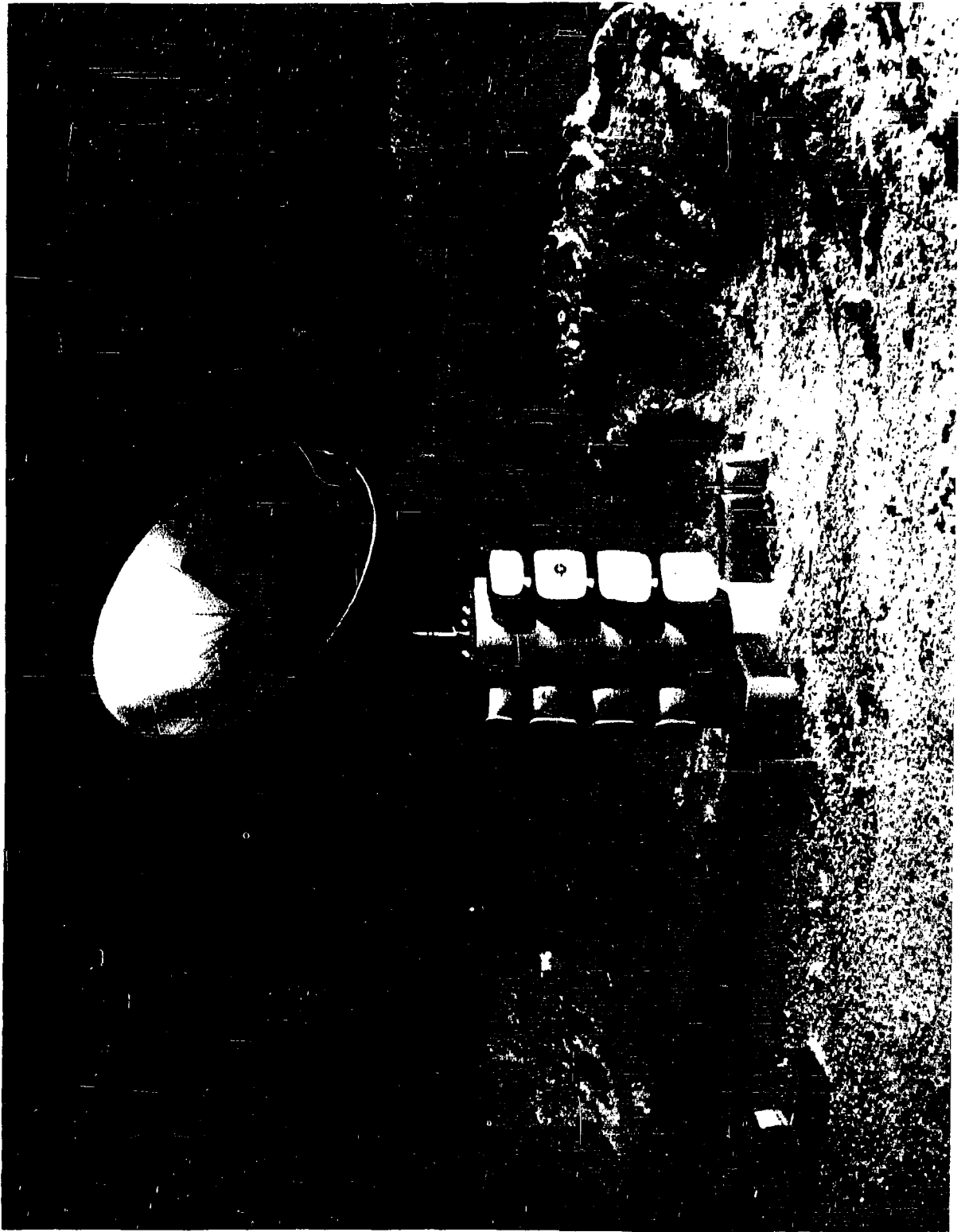

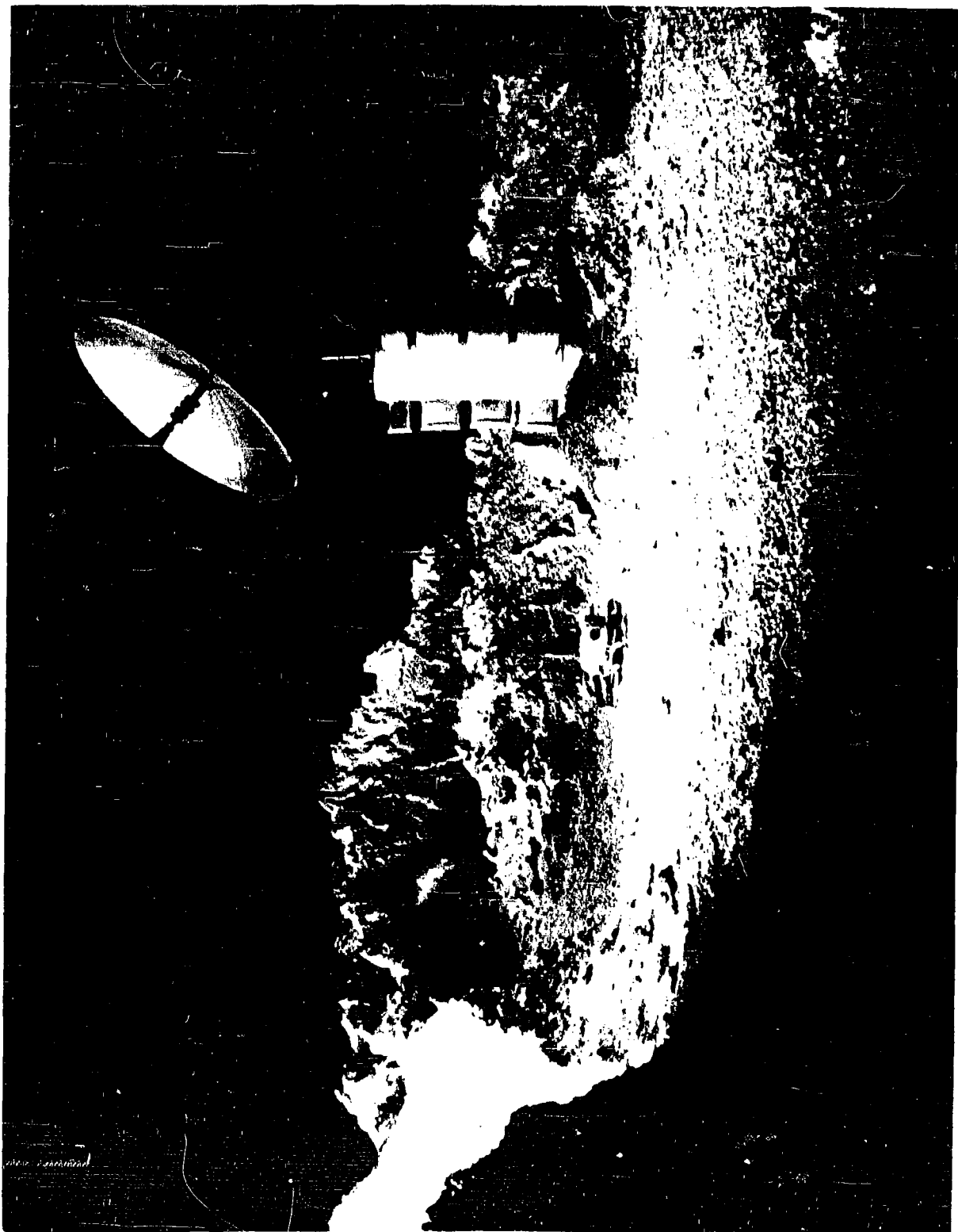

1950

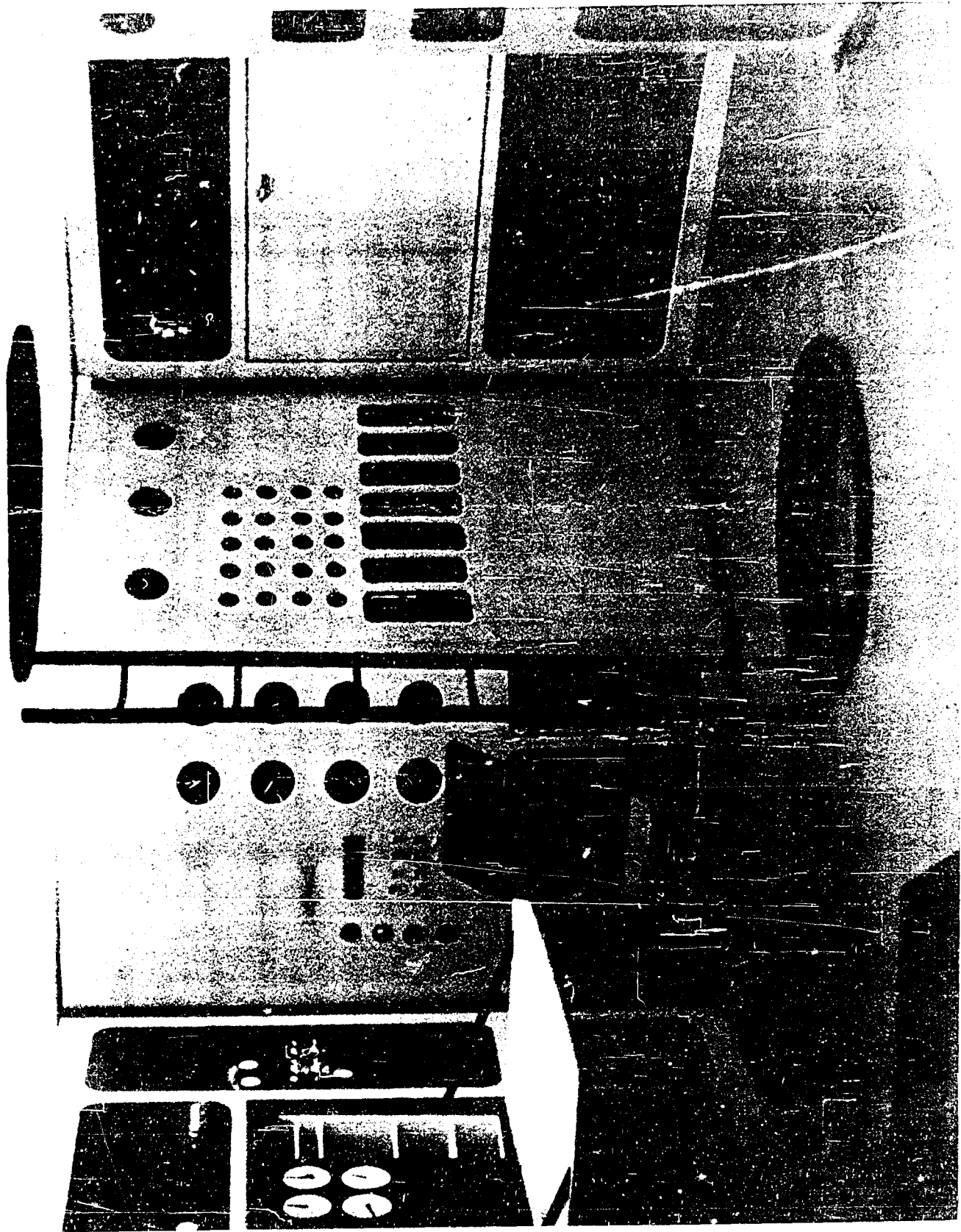

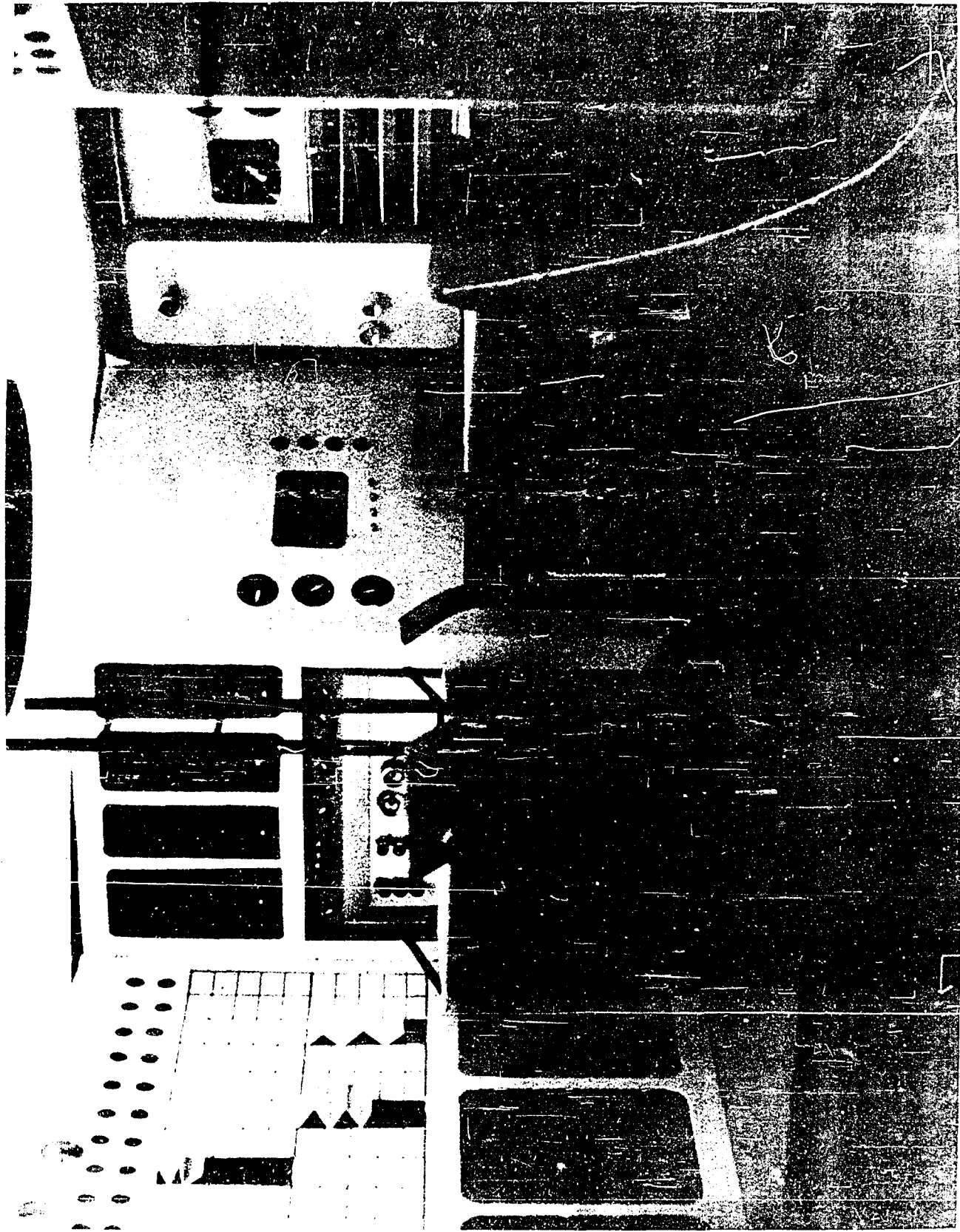

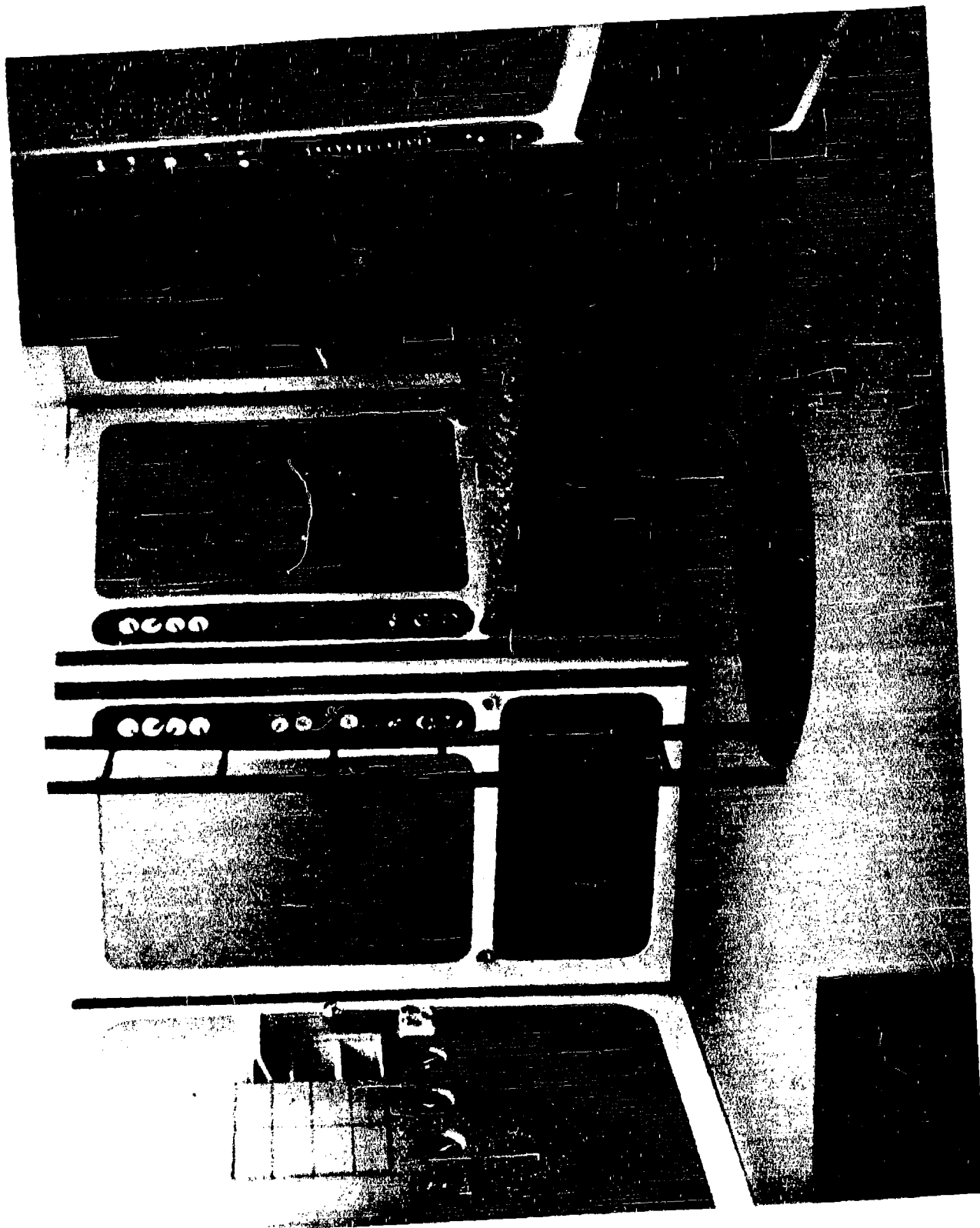

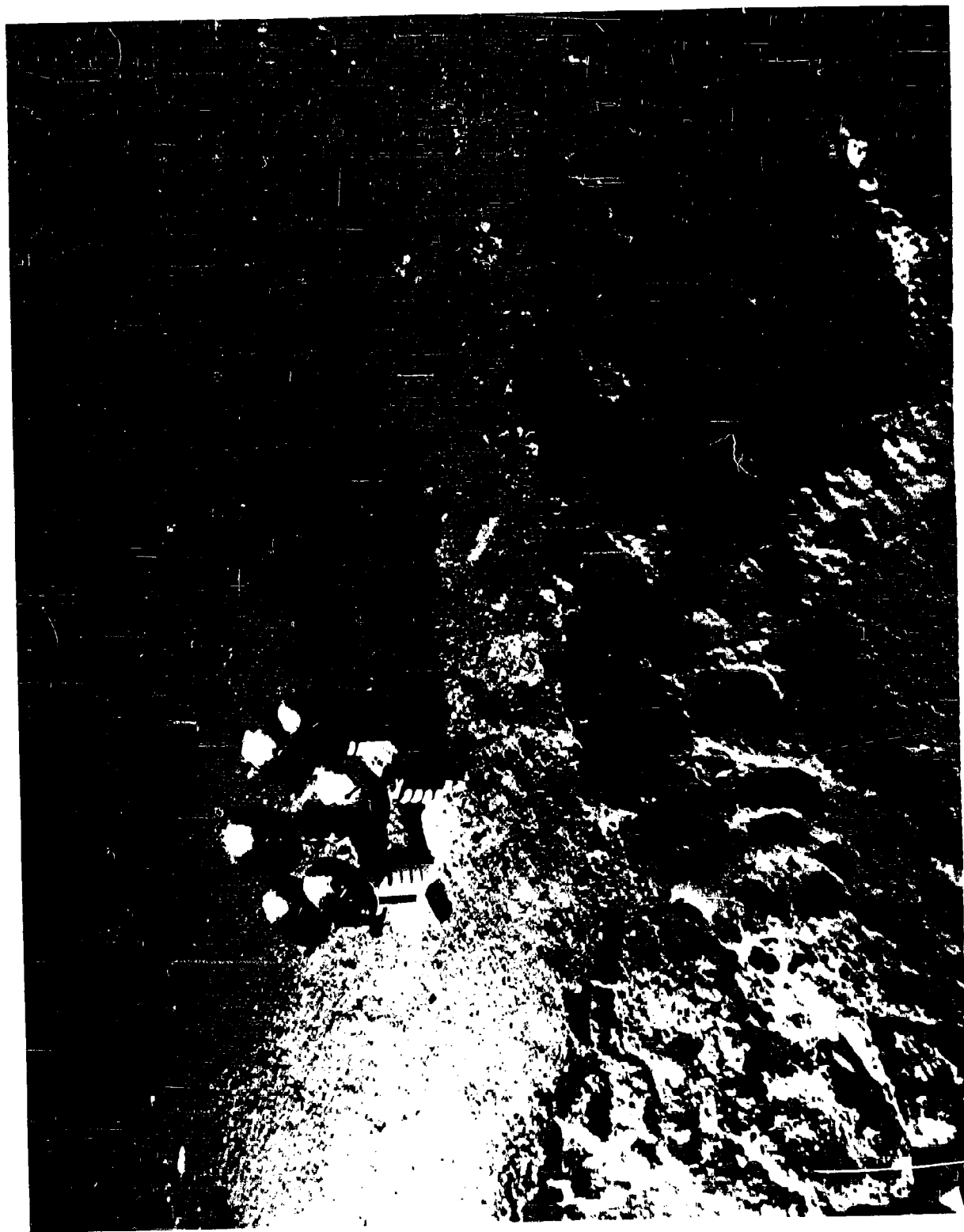

LUNAR SHELTER CONCEPTS

by

Thomas W. Berkhouse, Ind. Des. '63
Frank E. Conboy, Ind. Des. '64
Philip J. Franz, Arch. '64
Garnet S. Hoffmann, Arch. '64

1. DESIGN PHILOSOPHY

The concept of the lunar shelter is based on expandable prefabricated structural module units of housing. After these individual units have expanded, the micro-encapsulated foam reactants, which have been made to adhere to the inflatable structure, are activated by melting away the capsule covering.

It would seem wasteful to spend valuable time assembling a complicated shelter when time could otherwise be utilized for accomplishing the proposed mission. Therefore, a simple lunar shelter erected in a minimum of time and work is an integral part of this design philosophy. The high cost per pound for this shelter dictated the possible use of all parts of the rocket ship.

Another phase of our concept was to provide for conditions as close to those on earth as possible. As opposed to the buried shelter where man cannot relate himself to the exterior form, this lunar shelter with its four individual, definable shapes provides this important relationship of experiencing the external as well as the internal space as man does on earth.

2. PACKAGE AND ERECTION TECHNIQUES

The package techniques employed are designed to contain the four huts in the hull of the space ship along with the solar reflector, supplies and equipment necessary to sustain life in and around the shelter. A unique packaging feature is that the four shelter huts are able to fold to a height of 38 inches each and still have all the equipment contained within the hut thus eliminating the job of transporting furnishings and equipment into the hut after expansion.

The first step toward complete erection of the shelter is to remove the nose from the space ship and lift the four huts out of the space ship hull with the lunar roving vehicle. After the retro-rockets have been removed, the huts are "plugged" into the hull of the ship. The next step is to remove the solar collector and drop the movable sides of the upper 23 feet of the space ship hull, thus forming the protective ceiling over the huts.

The huts are expanded by internal air pressure and then foamed in place.

The space left between the structural members (space ship hull) is filled with balloon-shaped foam.

After everything is in place, lunar dust is piled on top of the roof. A lunar "stockade" is formed around the huts to afford protection from radiation and micrometeorites. The height of the lunar dust "stockade" walls and the ceiling line determine the angle of light and radiation permitted into the stockade.

3. STRUCTURES AND MATERIALS

The structure in the individual expandable huts is first provided by interior air pressure and then by activated hardened foam.

The 34 inch bases of the huts are of a double wall construction of the same type as used in the space ship hull, while the upper inflatable membrane is covered with micro-incapsulated foam reactants. After the huts are positioned in place and inflated, the capsules are melted away and the foaming action is initiated.

The structure in the ceiling covering of the stockade is made up of ribs of the space ship hull. At landing time these ribs form the upper 23 feet of the shell of the space ship hull. After the huts are in place, these ribs fall away on hinges at the lower ends. These ribs are held in a near-horizontal position by tension rings, and the voids left between the ribs are filled with balloon-shaped foam. The lower 12 foot portion serves as the central structural column for the umbrella-type stockade ceiling.

Lunar dust is used as a protective covering on the roof of the stockade and by forming walls around the lunar shelter.

4. FLOOR PLAN ANALYSIS

The lunar shelter is composed of an outer stockade wall which provides for a protected exterior space surrounding the huts. The reason for this space is to allow the men to experience the shape of the hut and relate themselves to both the exterior as well as the interior of the shelter.

The shelter proper is entered through the center core of the lower 12 feet of the space ship hull. By entering the central core, one first steps into an airlock which contains a shower to aid in decontamination of the space man's suit. The central core also contains storage compartments for lunar probing equipment and suits.

In the 5 feet 6 inch space above the central core, is positioned the central water supply system and mechanical equipment.

From the central core one may enter any one of the four individual room huts. By placing different activities of lunar shelter life in different room huts, a condition as near to earth living has been provided. Each room hut contains its own air supply.

One hut contains food preparation equipment as well as dry food and refrigerated food storage. Another hut contains recreational and conference facilities while another contains the laboratory equipment. The fourth hut contains the sleeping and infirmiry facilities along with personal clothing and toilet facilities.

The solar collector is centrally-mounted over the lunar shelter.

5. ENVIRONMENTAL PROTECTION

Environmental protection is achieved through a series of lunar dust and foam layers on the different shelter parts.

The outermost protection is the lunar dust stockade walls. The umbrella roof of the shelter is made up of 5 feet of lunar dust, 2 feet of foam and structural ribs of the expanded space ship hull.

The lunar huts themselves offer additional protection with their structural foam skin.

6. INTERIOR FURNISHINGS AND EQUIPMENT INTEGRATION

All furnishings and equipment will be packaged in their places of use. All furnishings in the huts will be built in and expanded into place when the huts are expanded. During flight these furnishings will be packaged in the 30 inches of uncollapsible hut.

7. STATISTICAL INFORMATION

Areas and Volumes

Unexpanded Hut - 156 sq.ft. - 467 cu.ft.
Expanded Hut - 156 sq.ft. - 1250 cu.ft.
Central Core - 175 sq.ft. - 1400 cu.ft.
Mechanical Equipment - 175 sq.ft. - 960 cu.ft.

Lunar dust required to build stockade - 47,760 cu.ft.

8. THEORETICAL ADVANTAGES OF THIS CONCEPT

The advantages of this concept are simplicity in assembling high ratio of volume to package volume of built-in equipment and furnishing, and the personal relationship of the exterior to the interior shape by the individual.

LUNAR SHELTER

BERKHOISE
CONBOY
FRANZ
HOFFMANN

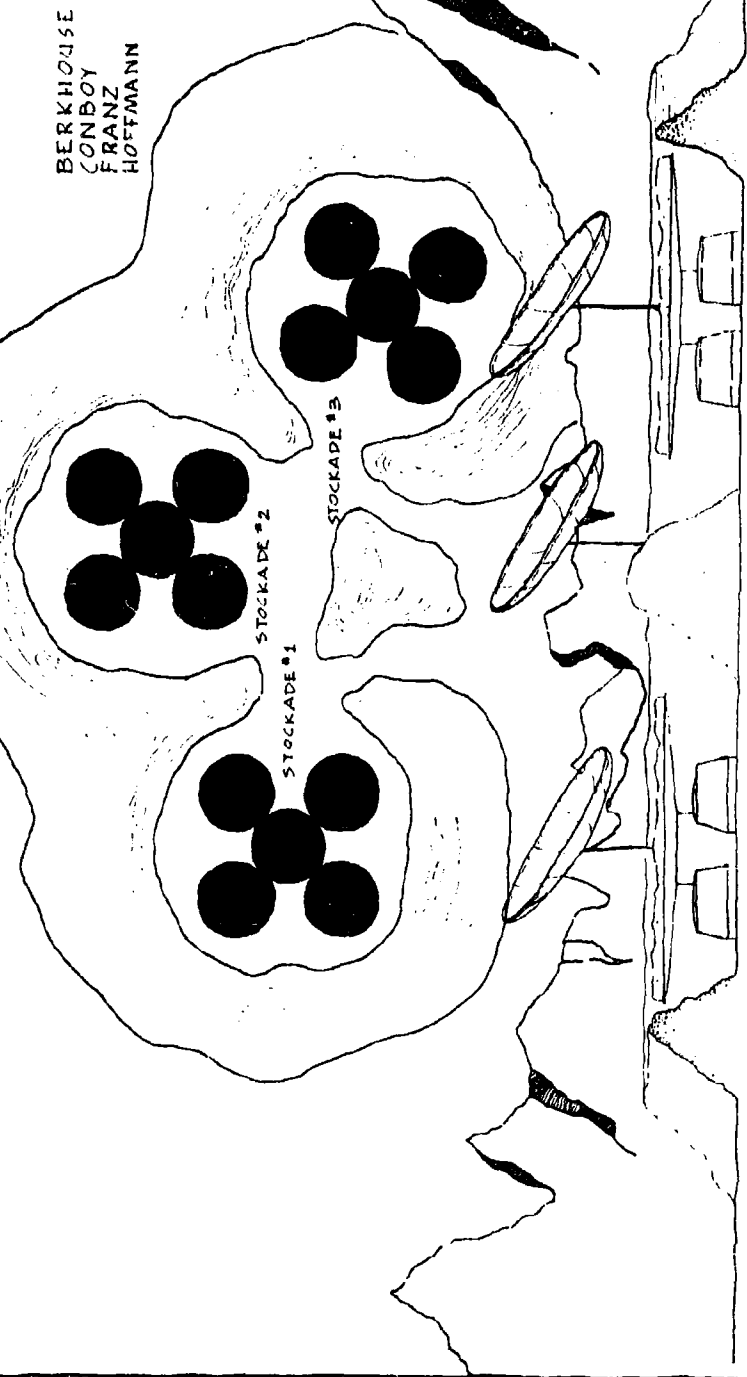

COLONY

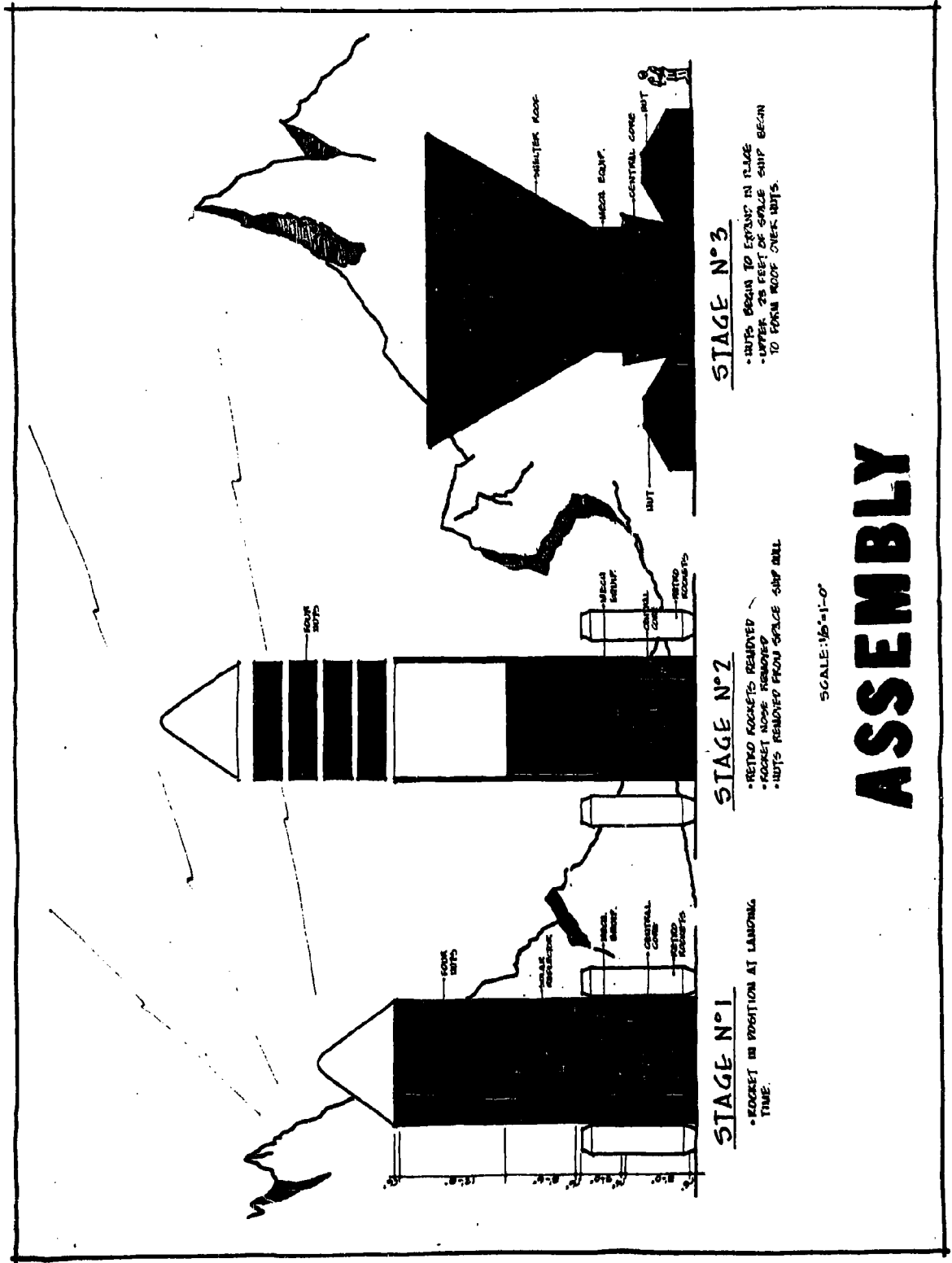

ASSEMBLY

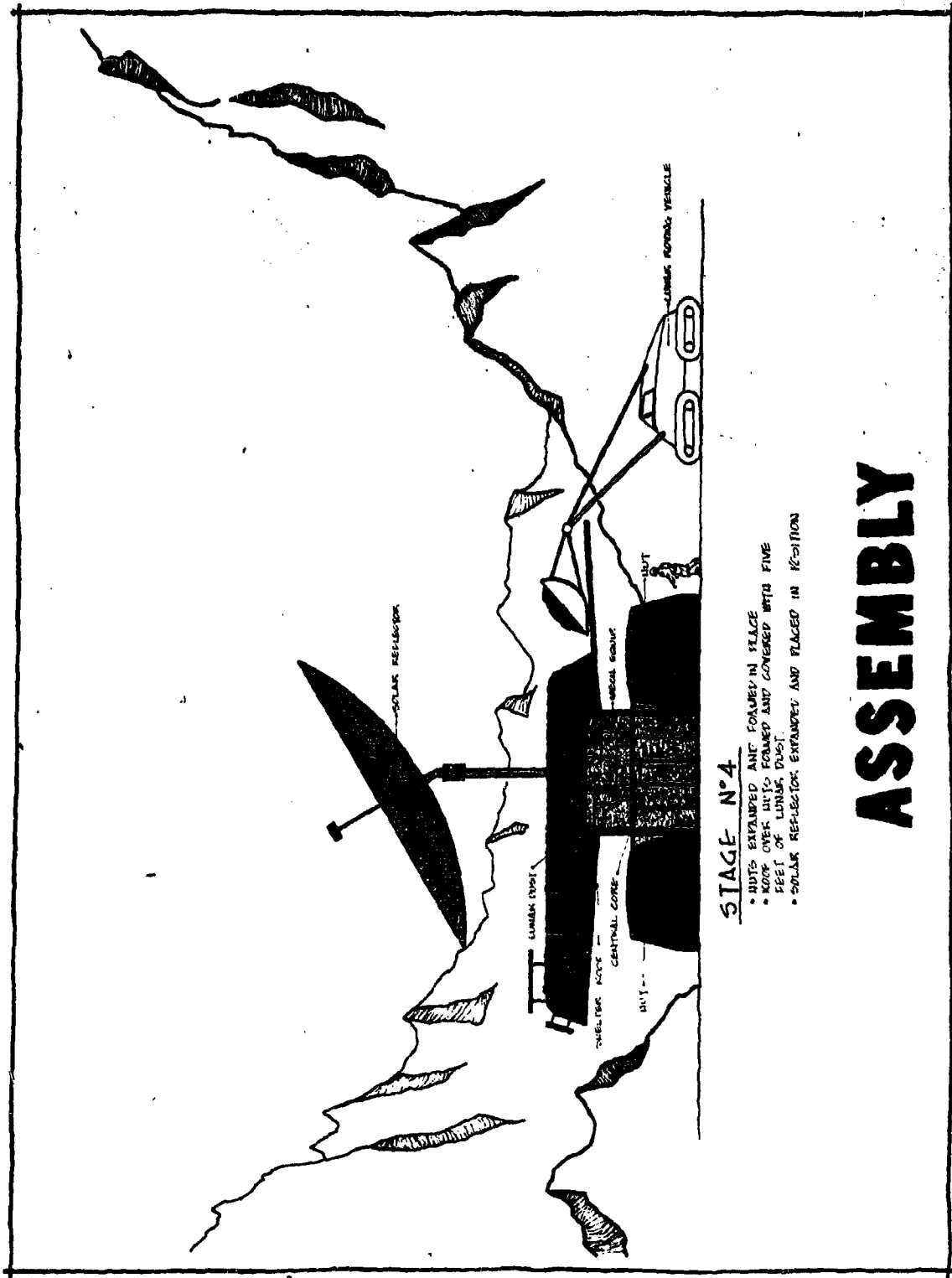

ASSEMBLY

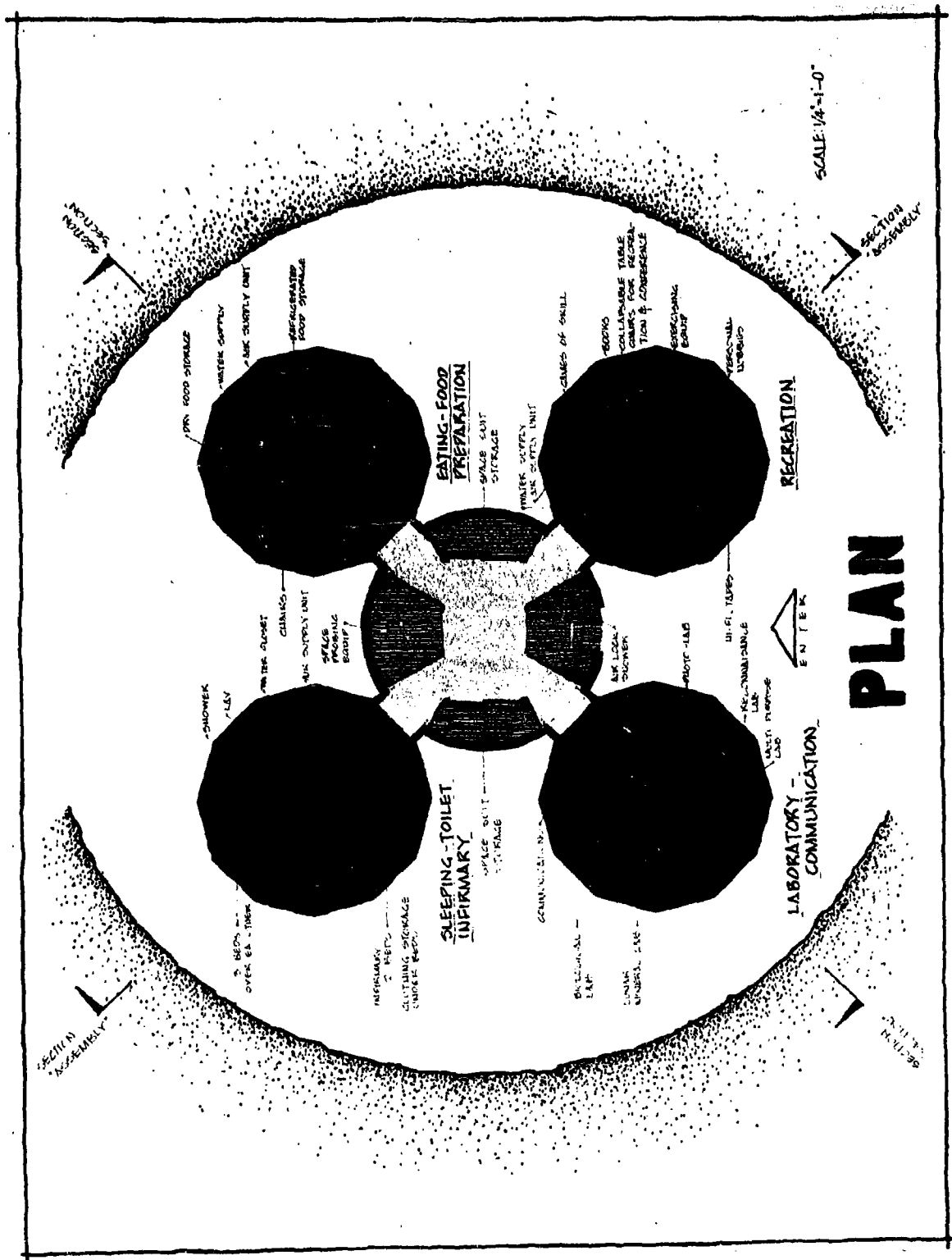

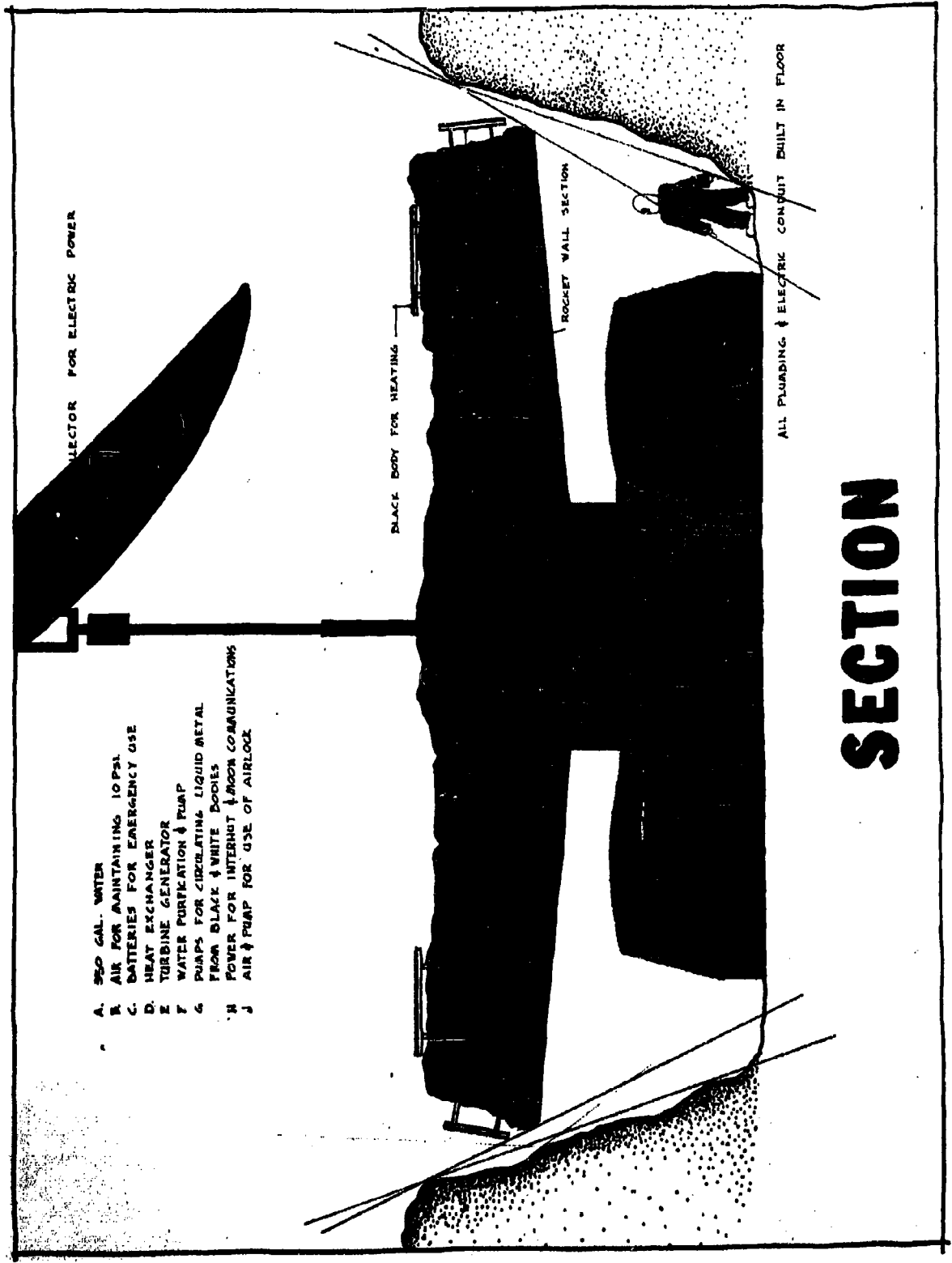

COLLECTOR FOR ELECTRIC POWER

BLACK BODY FOR HEATING

ROCKET WALL SECTION

ALL PLUMBING & ELECTRIC CONDUIT BUILT IN FLOOR

- A. 550 GAL. WATER
- B. AIR FOR MAINTAINING 10 PSI
- C. BATTERIES FOR EMERGENCY USE
- D. HEAT EXCHANGER
- E. TURBINE GENERATOR & PUMP
- F. WATER PURIFICATION & PUMP
- G. PUMPS FOR CIRCULATING LIQUID METAL FROM BLACK & WHITE DOORS
- H. POWER FOR INTERCOM & MOON COMMUNICATIONS
- J. AIR & PUMP FOR USE OF AIRLOCK

SECTION

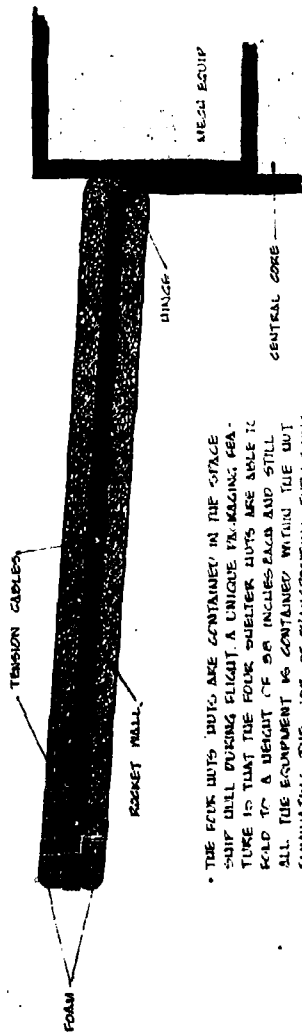

SHELTER ROOF DETAIL
SCALE 3/8"=1'-0"

THE FOUR HUTS ARE CONTAINED IN THE SPACE SHIP HULL DURING FLIGHT. A UNIQUE PACKAGING FEATURE IS THAT THE FOUR SHELTER HUTS ARE MADE TO HOLD TO A HEIGHT OF 80 INCHES EACH AND STILL ALL THE EQUIPMENT IS CONTAINED WITHIN THE HUT ELIMINATING THE JOB OF TRANSPORTING PROVISIONS AND EQUIPMENT INTO THE HUT AFTER EXTENSION. THE FOUR HUTS ARE LIFTED OUT OF THE HULL AND PLUNGED INTO THE CENTRAL CORE THE HUTS ARE EXTENDED BY INTERNAL AIR PRESSURE AND PLACED IN PLACE. THE NEXT STEP IS TO DRAP THE WATER 25 FEET OF THE SPACE SHIP HULL. THE SPACE LEFT BETWEEN THE STRUCTURAL MEMBERS OF SPACE SHIP HULL IS FILLED WITH POLYURETHANE FOAM.

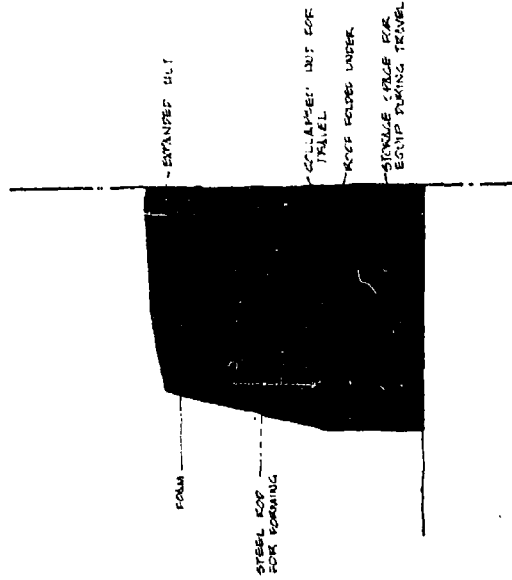

HUT DETAIL
SCALE 9/8"=1'-0"

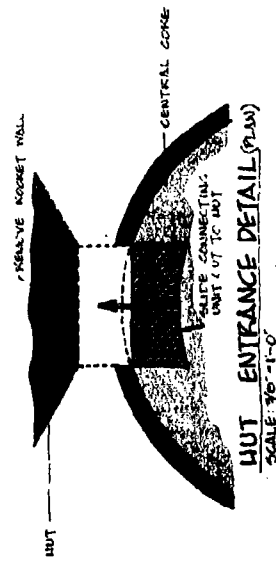

HUT ENTRANCE DETAIL (PLAN)
SCALE 3/8"=1'-0"

DETAILS



RECREATION

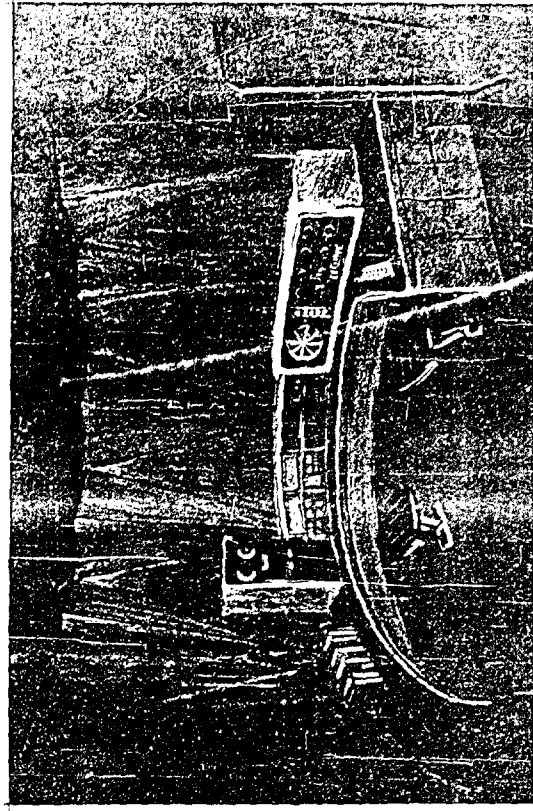

LAB - COMMUNICATION

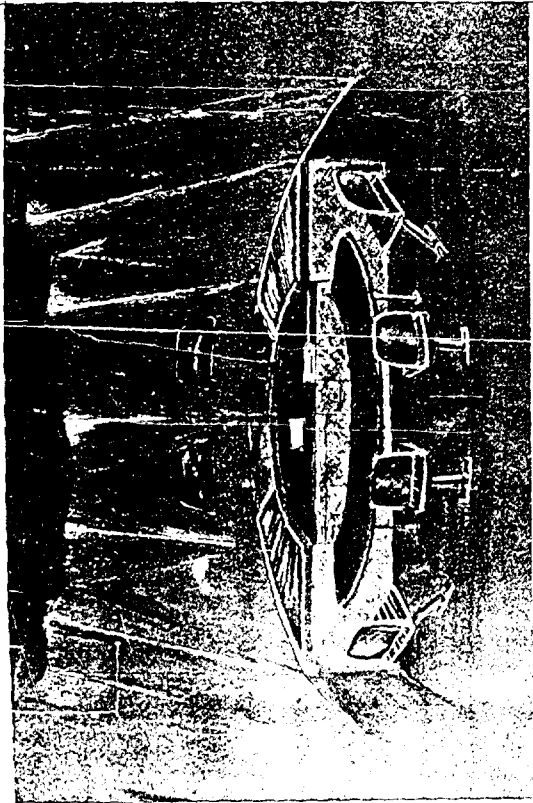

DINING

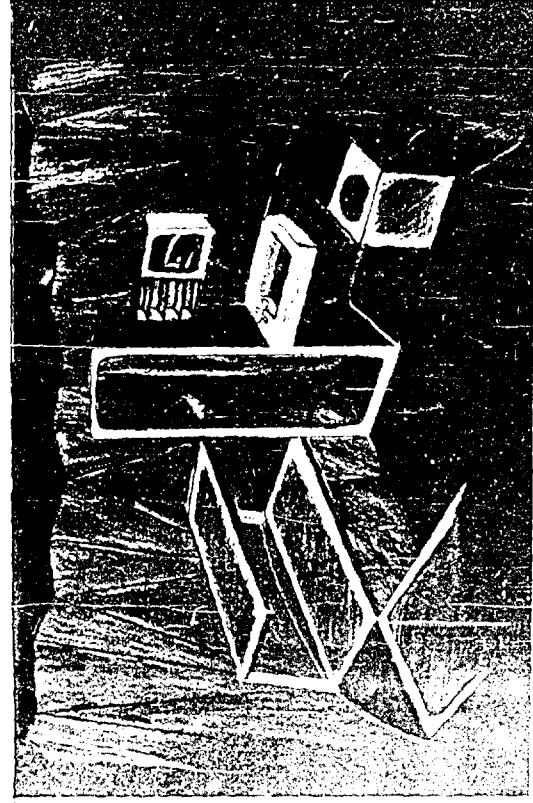

SLEEPING

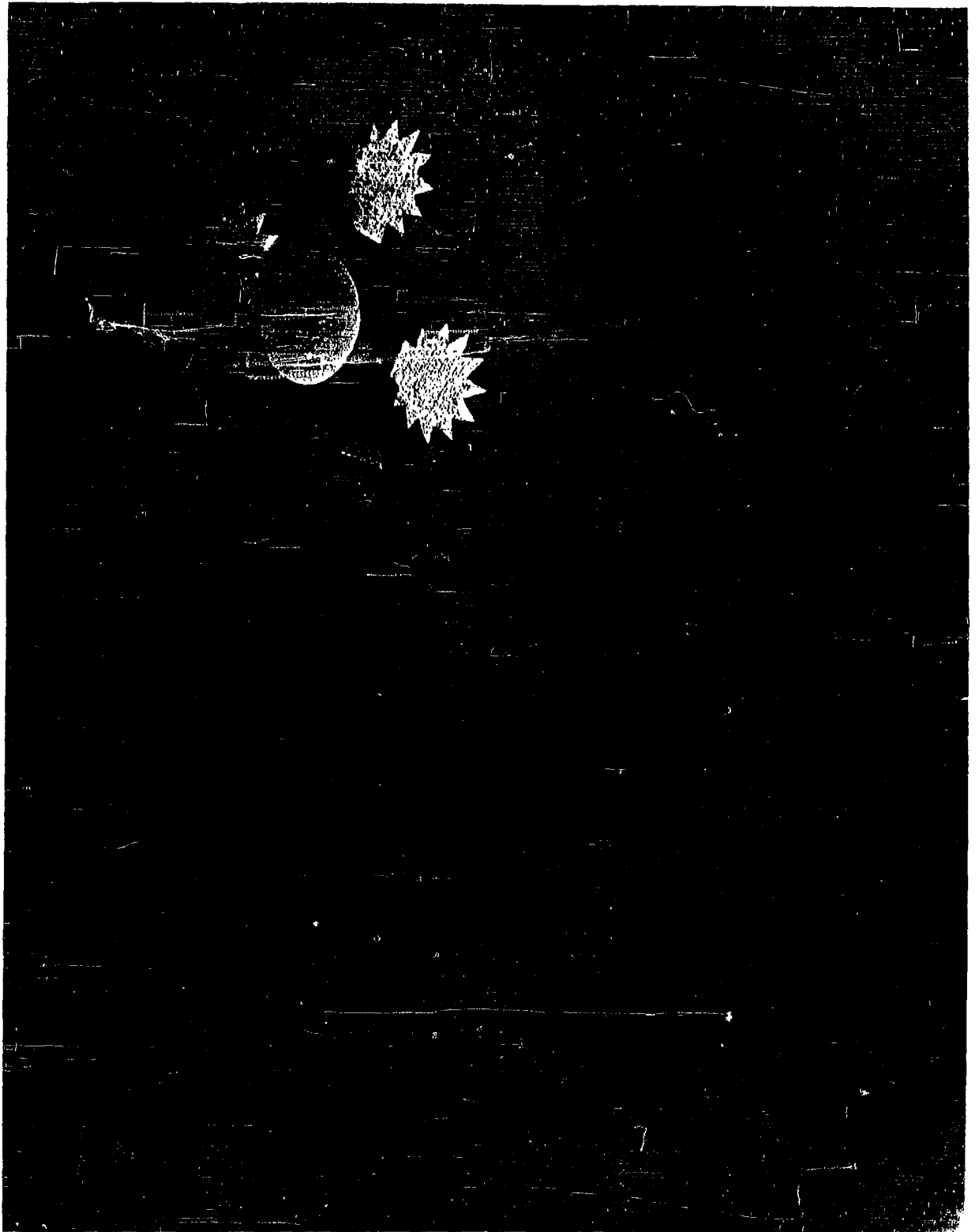

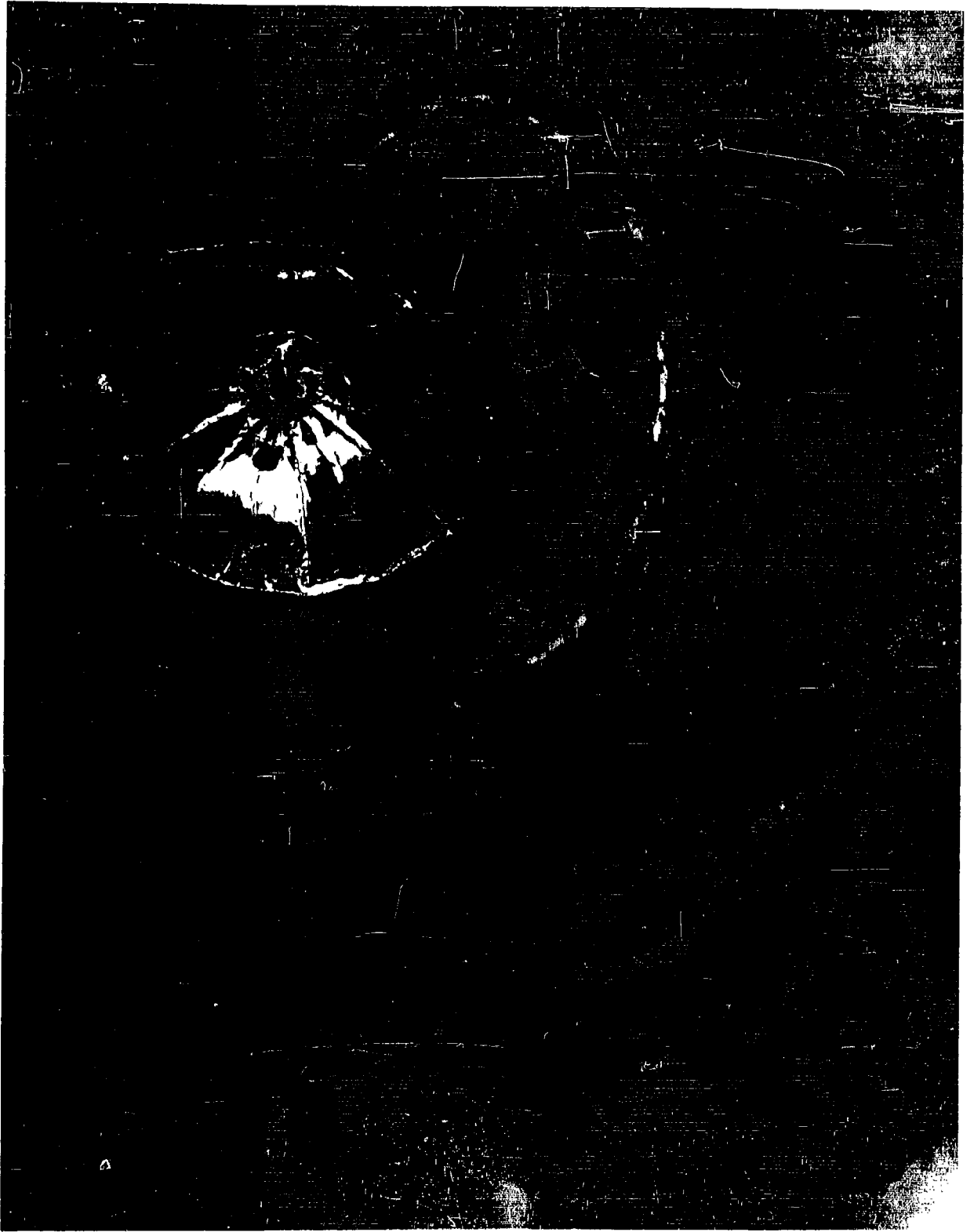

LUNAR SHELTER CONCEPTS

by: De Baum, Howard (Ind. Des. '63)

Wells, John (Arch. '64)

Wyler, John (Arch. '64)

Yelton, Robert (Arch. '64)

DESIGN PHILOSOPHY

The approach to design was based upon certain critical, but fundamental, criteria. This shelter had to be a self-contained unit for nine men for thirty days, with the ability to satisfy both physical and mental desires. Due to the conditions of launching a vehicle out of earth's gravity through the cold voids of space onto the lunar surface, it became necessary to conceive a shelter both structurally sound and light in weight, and with the ability of functioning as a shelter on dropping to the moon's surface. For these reasons, the package casing will be the structural units with the whole shelter being opened automatically, producing a fixed environment into which the men can escape.

In doing this we made certain necessary assumptions, which, in the future, will have to be proven before this concept could become functional. The first and most necessary is that the men, the lunar vehicle, and the shelter will arrive in different rockets but will land in very close proximity to each other.

PACKAGE AND ERECTION TECHNIQUE

The rocket will be sent directly from earth with a lunar package thirty-five feet in length by fourteen feet six inches in diameter. The upper five feet will house pod rockets with adjustable legs capable of securing the rockets in the vertical position. This upper portion

contains the solar reflector, heat transfer equipment, communications equipment, and television cameras.

This tower-like structure will also act as a gantry for lowering the thirty foot shelter (with the aid of the lunar vehicle) into the appropriate horizontal position in a hole produced by explosives fired from the descending rocket. At placement, the package would automatically be split open, separating into equal halves ready for habitation. Leg-like structures will then level the shelter in preparation for covering with lunar substance. All cables and lines would be already connected to the gantry. This whole procedure would take a minimum amount of time saving the men for more useful research.

STRUCTURES AND MATERIALS

The lunar shelter is to be completely prepackaged, supplied, and built on earth using the capsule shell of the package as the structural members. This shell will be filament-wound asbestos-phenolics. The cylindrical shell will fuse into equal halves using silicone - hydraulics to separate the sections nine feet apart, with solid insulated folding partitions expanding simultaneously with the division of the shells guaranteeing always an earth-type environment within the station.

FLOOR PLAN ANALYSIS

The layout selected is based upon the necessity for individuality of function. The shelter therefore has been sectionalized, helping to ensure safety measures to the adjoining areas. The two-floor arrangement produces the most efficient uses of the existing cubic footage.

On entering the shelter, it is necessary to pass through the air locks and adjoining dressing area, then into the circulation area where the control and communication console and the elevator are located. The upper level is assigned to work and research, while the lower contains the living and sleeping area; This creates an atmosphere commensurable with one's proclivity to earth.

ENVIRONMENTAL PROTECTION

Due to the tremendous environmental difficulties, it became necessary to shield the shelter from direct contact with the outside. This shield is basically designed to protect against radioactivity, but also provides protection against meteorite bombardment. The shield is based upon using lunar materials rather than having to carry materials from earth. The solution most reasonably derived is to place the shelter below grade insuring a constant temperature, and, after covering, yielding protection against radioactivity and meteorite.

INTERIOR FURNISHINGS AND EQUIPMENT INTEGRATION

All interior equipment is prepacked and ready for use before leaving earth. The equipment has been arranged

to afford accoustical isolation of each function. Extraneous noises therefore will be reduced to a bare minimum. All furniture selected is light weight, folding, and with the capability for multi-purpose use. All sitting areas will be aluminum frame with nylon webbing and magnetic legs for greater stability. Color selection has been pointed toward insuring high mental stability. Besides this, each man's equipment will be individually colored. The over-all appearance of the interior will be bright with a multitude of colors.

STATISTICAL INFORMATION

DESCRIPTION	AREA	VOLUME
Upper Level		
Air lock	24 sq. ft.	150 cu. ft.
Changing area (including spacesuit storage)	81 sq. ft.	575 cu. ft.
Exterior equipment storage	25 sq. ft.	150 cu. ft.
Thermal control equipment		70 cu. ft.
Circulation area	63 sq. ft.	430 cu. ft.
Elevator	25 sq. ft.	
Control panel	49 sq. ft.	275 cu. ft.
Emergency power		90 cu. ft.
Laboratory (including benches)	350 sq. ft.	2100 cu. ft.
Lower Level		
Sleeping area (including storage and beds)	150 sq. ft.	1125 cu. ft.
Air storage (two)		250 cu. ft. each
Circulation	63 sq. ft.	450 cu. ft.
Elevator	25 sq. ft.	
Toilet area	25 sq. ft.	175 cu. ft.

Waste purification equipment		125 cu. ft.
Air purification equipment		125 cu. ft.
Living area	110 sq.ft.	825 cu. ft.
Food storage and preparation		200 cu.ft.
First aid and study area	25 sq. ft.	175 cu. ft.
Recreation equipment and storage	27 sq. ft.	175 cu. ft.
Air storage		150 cu. ft.
Water storage		150 cu. ft.

THEORETICAL ADVANTAGES OF THIS CONCEPT

This concept has many advantages over the more idealistic presentations normally associated with space research. Here are just a few of this concept's more pronounced advantages: (1) It yields a high percentage of efficiency of over-all volume-to-package weight. (Every portion of the lunar package is utilized). (2) It is rather easy to increase volume with a minimal increase in weight. (3) The package is "self-constructing" (decreasing building time immensely because everything is prepackaged, self-sealing, and ready to use on opening). (4) It also would be very easy to design a colony around this space shelter by merely connecting entrance tubes to a multi-shelter air lock.

The simplicity of design, construction and circulation all illustrate the reason that this concept is essentially the most advantageous for the first lunar shelter.



EXTERIOR VIEW

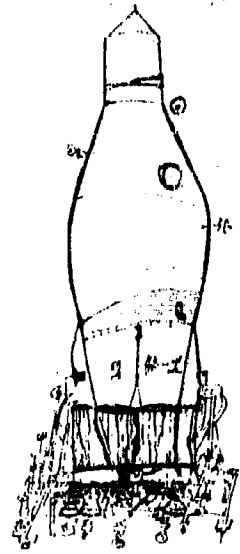

LUNAR SHELTER
DEBAUN WELLS WYLER YELTON

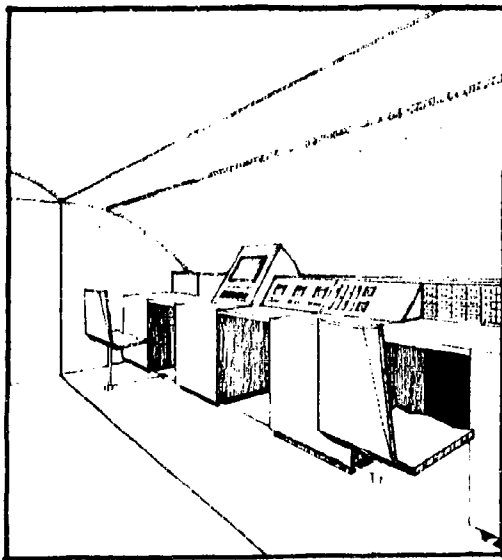

LABORATORY AREAS

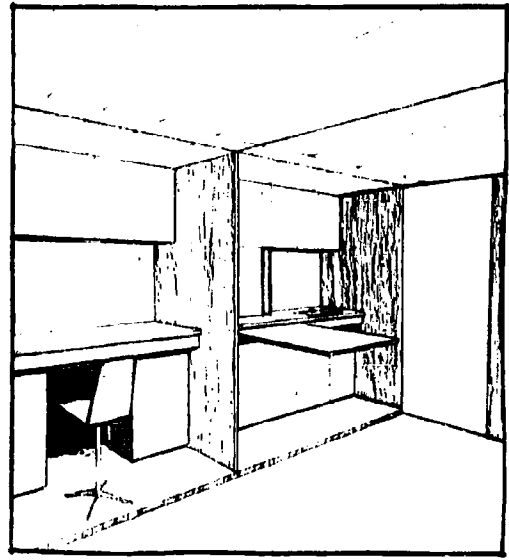

LIVING & RECREATION

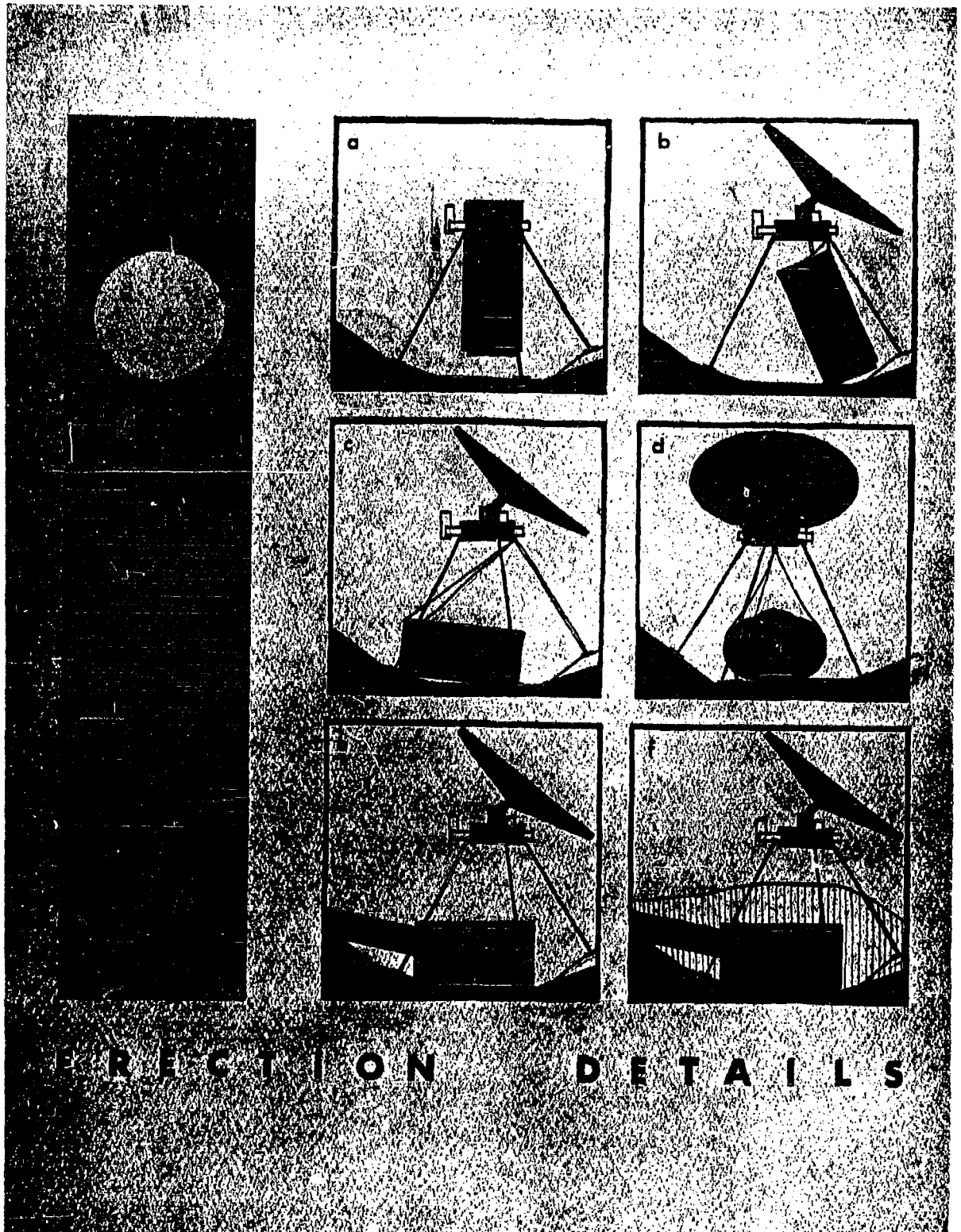

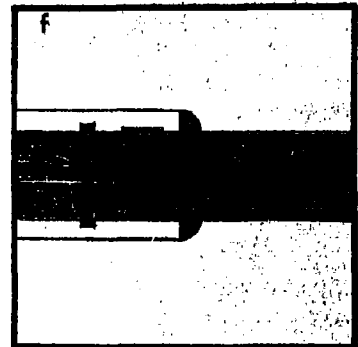
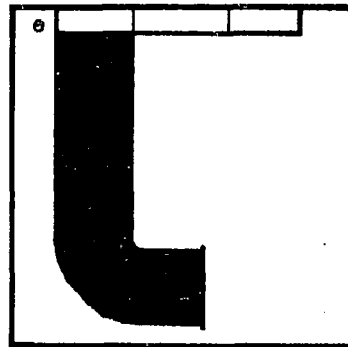
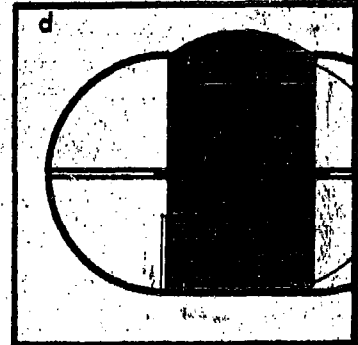
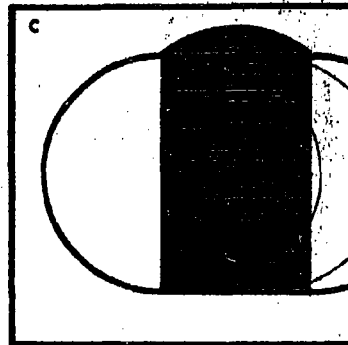
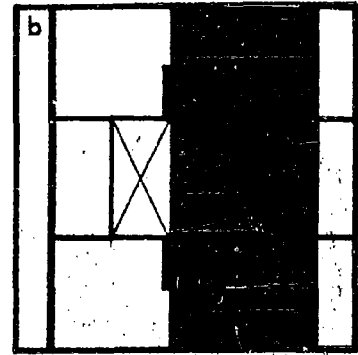
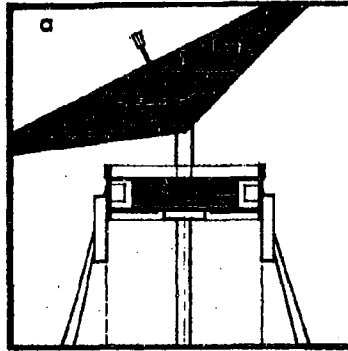

E R E C T I O N D E T A I L S

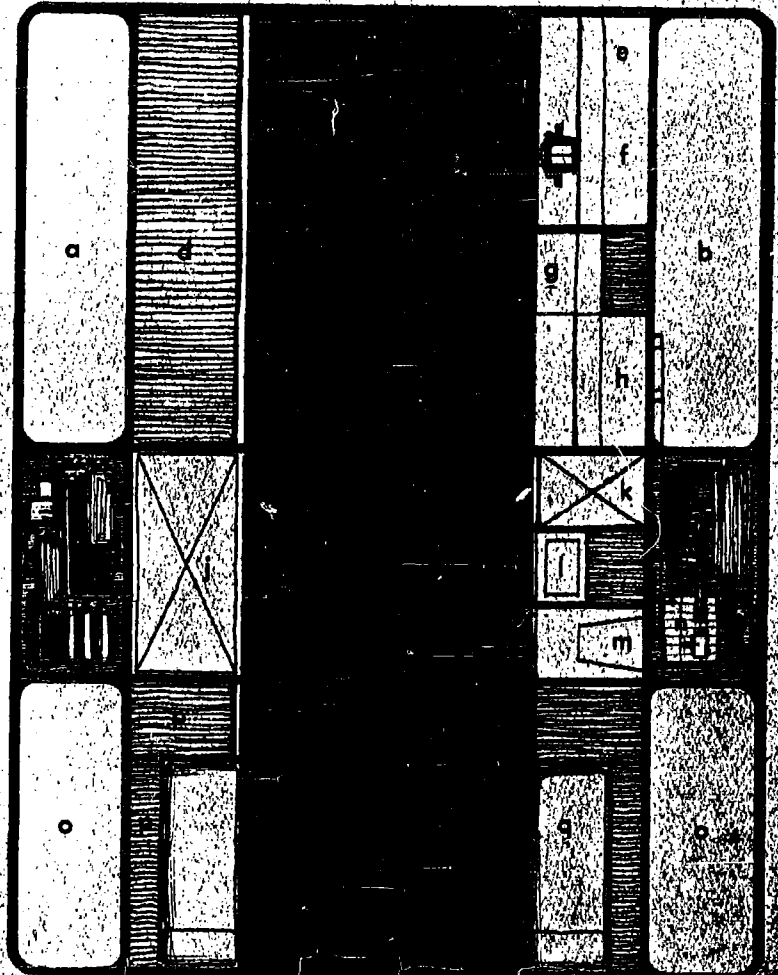

LOWER LEVEL PLAN

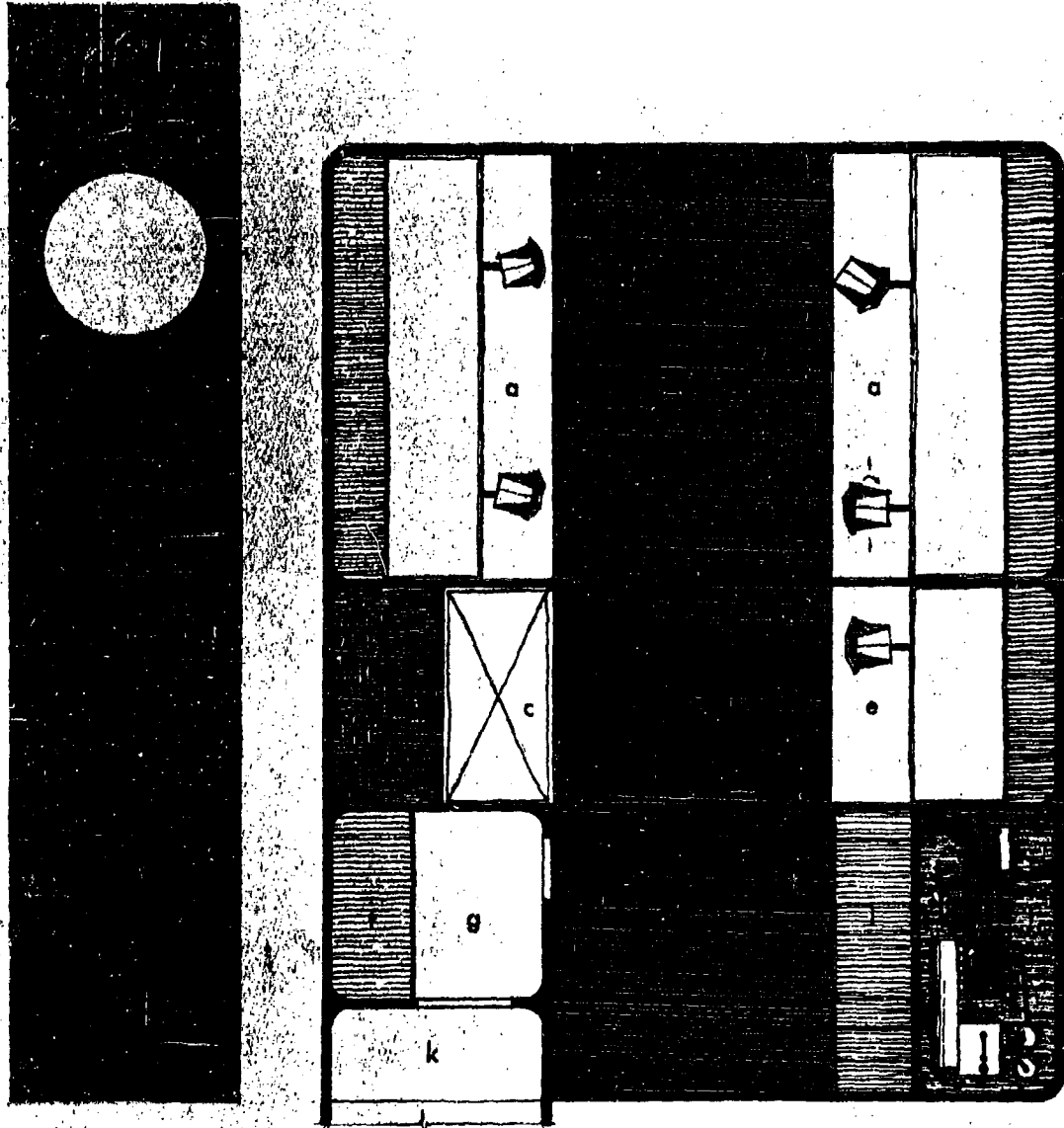

U P P E R L E V E L P L A N

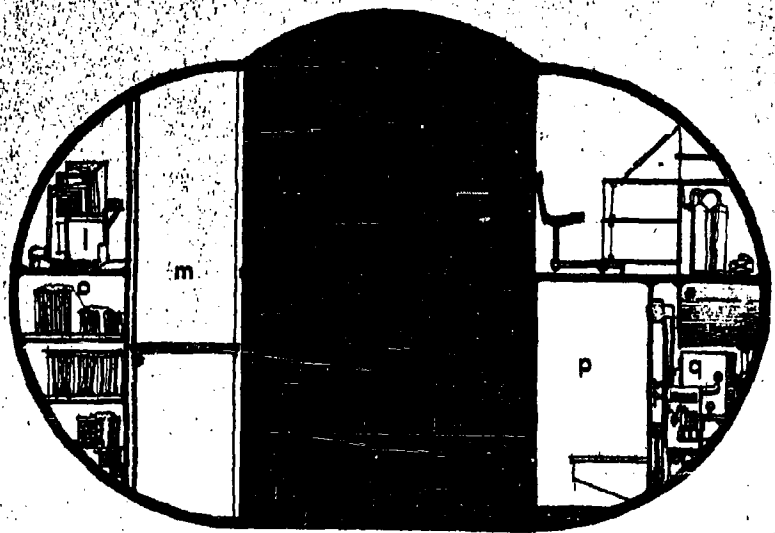
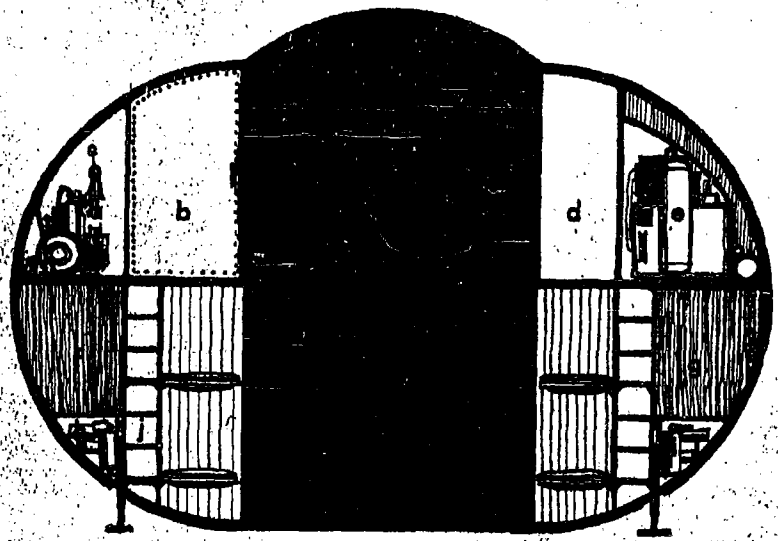
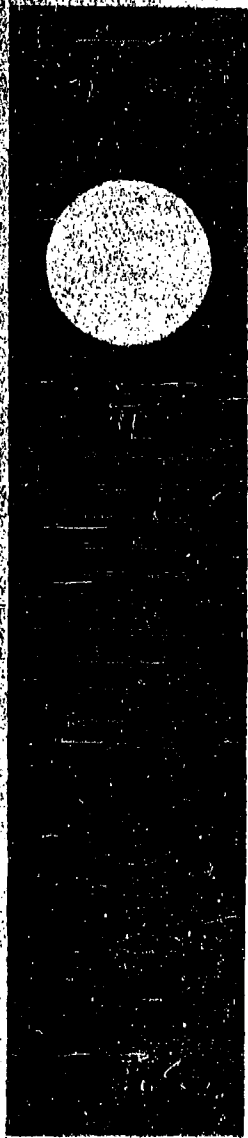

CROSS SECTIONS

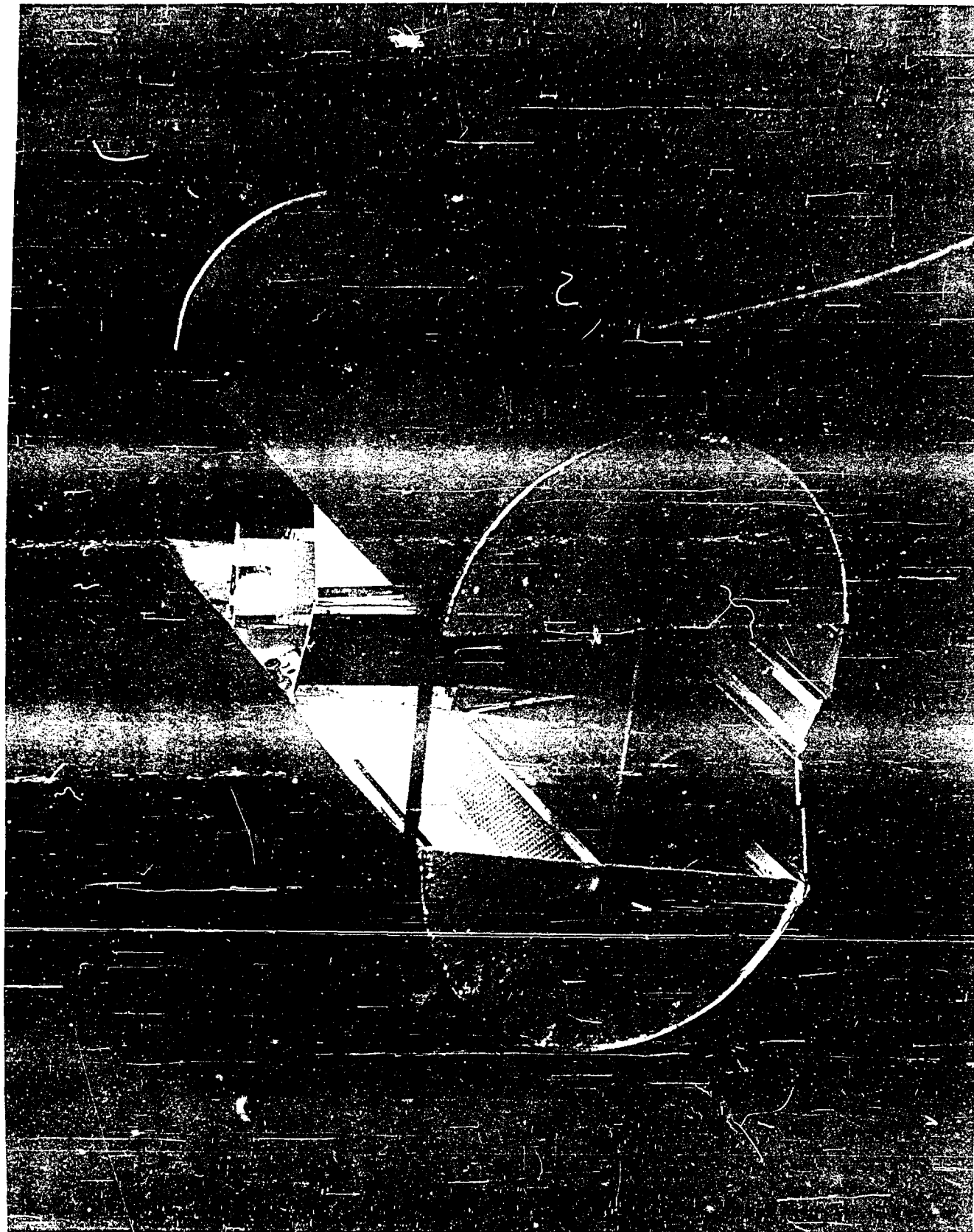

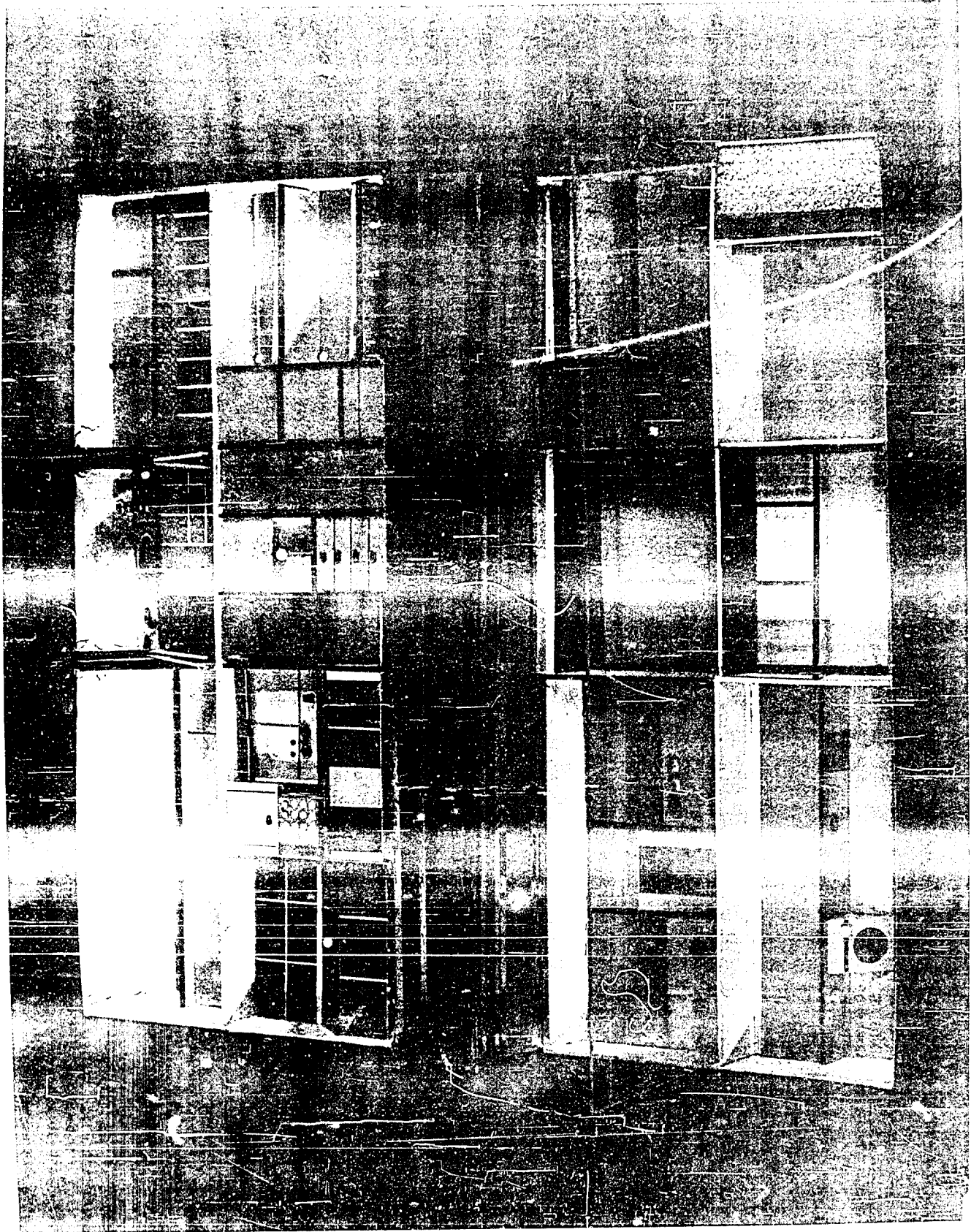

LUNAR SHELTER CONCEPT

Gene Brethauer	Architecture	'64
Lee Coburn	Architecture	'64
Mike Proffitt	Ind. Design	'64
Stan Waechter	Ind. Design	'63

DESIGN PHILOSOPHY

The mission, of which this shelter is a vital part, to establish a manned exploratory base of operations on the Moon will be subject to hazards and harsh demands indigenous to space travel and Moon environment and will, therefore, tax heavily the minds and bodies of the crew.

We feel this taxation must be balanced by use of a shelter on the Moon providing adequate, at least, food, rest, work and recreation to restore and maintain the physical condition of the men during the mission and for the return trip to Earth.

Our objectives then, were to design an easily erected, compact and yet spacious, complete and reasonably comfortable shelter.

PACKAGE AND ERECTION TECHNIQUES

Our solution took shape as a self-contained, semi self-erecting unit requiring virtually no manual labor for exterior set-up and very little for the interior.

LUNAR SHELTER CONCEPT

Upon arrival, the Moon vehicle using a portable crane will remove the shelter package from its booster rocket and transport it to the erection site. Then;

1. Remote controlled latches release the storage compartments forming the upper missile body
2. The floor sections forming the lower missile body are released by explosive bolts and swung downward exposing the inflatable shelter.
3. Canned "atmosphere" shapes the inflatable section of the shelter, followed by introduction of gasses into the wall cavities of same activating and rigidizing the foaming plastic placed there during manufacture. Noxious gasses resulting from the chemical reaction are vented to the outside via small vent holes provided in the outer skin.
4. The umbrella-like solar reflector may then be raised to the top of the elevator-airlock shaft freeing the elevator capsule for use.

The shelter may now be entered and work may progress inside as well as outside (in the space of approx. one hour)

5. The exterior of the shelter is now covered by ten feet of Lunar dust by use of the Lunar vehicle. The unfolding of the solar reflector completes the setup and the shelter may swing into operation.

LUNAR SHELTER CONCEPT

STRUCTURE AND MATERIALS

Since the entire structure is prefabricated, there is nothing for the crew to construct on the Moon site save the remote shelters which are strictly optional.

The central core assembly is basically an aluminum space-frame covered with an aluminum skin - the spaces between uprights being filled with polyurethane foam for rigidity and insulation. The elevator capsule and solar reflector base have their outside diameters coated with "Teflon" to prevent sticking in the center shaft before air is introduced to provide a bearing cushion.

Utilizing the inherent structural strength of plastic foam as applied to a dome shape, the inflatable portion of the shelter is constructed as a sandwich - that is, it consists of two layers of flexible skin spaced apart by cross hairs 'a la Goodyear "Airmat".

The cavity between skins is filled by the foam as it expands. The foam material is laminated to the insides of the skins during assembly.

This construction allows increased space without proportionate increases in weight.

With the shelter inflated, gas is introduced to the wall cavity via tubes built into the wall, and the chemical reaction expands and rigidizes the foam making the

LUNAR SHELTER CONCEPT

structure self-supporting and able to support the load of Lunar dust to be placed upon it.

The central core supports the remainder of the shelter including the solar generating unit and reflector.

FLOOR PLAN ANALYSIS

By creating a centralized circulation area, a logical room configuration developed. From this area, all rooms are easily and readily accessible.

Water and food storage is located near the greatest need.

Airlock doors slide to the side to avoid being hit by the descending elevator capsule.

ENVIRONMENTAL PROTECTION

Site conditions;

1. An existing crater may be used.
2. A depression may be made by explosives or by the Lunar vehicle.
3. The shelter may be erected on a flat open site.

In all three cases the shelter would be covered with ten feet of Lunar dust for radiological and meteoroid protection.

LUNAR SHELTER CONCEPT

Protection at the top of the elevator shaft is achieved by thick shielding within the solar reflector base and by shielding in the walls of the entrance cone.

Additional protection is available to field workers in the form of emergency shelters constructed (as an option) from the storage compartments from the upper section of the shelter package.

INTERIOR FURNISHINGS AND EQUIPMENT INTEGRATION

The majority of the interior furnishings will be pre-positioned during prefrabrication and will be of construction similar to the inflatable walls- namely plastic foam -and are actuated by a special gas injection machine.

A number of moveable furniture pieces of similar construction are also used.

Additional prefrabricated units for cooking, refrigeration, etc., are small and easily carried to position in the rooms. The main refrigeration unit is built into the central core above the bottom floor and functions also as an air purification device. It is accessible from the elevator shaft should repair be necessary.

Adequate facilities are provided for bathroom, lab., sleeping and recreation (music, reading, gymnastics) and meditation.

LUNAR SHELTER CONCEPT

THEORETICAL ADVANTAGES

Easy rapid set-up of this shelter will allow the crew to establish operations very quickly and with a positive minimum of exposure to the hostile Lunar environment.

The livability of this shelter will promote a continued high level of moral and physical fitness with a correspondingly high degree of efficiency in evidence in the performance of the crew.

The obvious advantages of prefabricated airlock, air-tight doors, plumbing system, etc., coupled with excellent strength and acoustical properties of the foam plastic dome (not to mention the spaciousness) are some of the merits of this concept.

STATISTICAL INFORMATION

Dome height (inside).....	Max. 13'-0",	Min. 8'-0"
Circulation area.....	78	sq. ft.
Physical Exercise area.....	110	" "
Recreation area.....	330	" "
Chapel area.....	18	" "
Laboratory area.....	98	" "
Sleeping area.....	105	" "
First Aid area.....	98	" "
Kitchen area.....	130	" "
Bath area.....	38	" "
Storage area.....	40	" "

TOTAL AREA 1043 sq. ft.



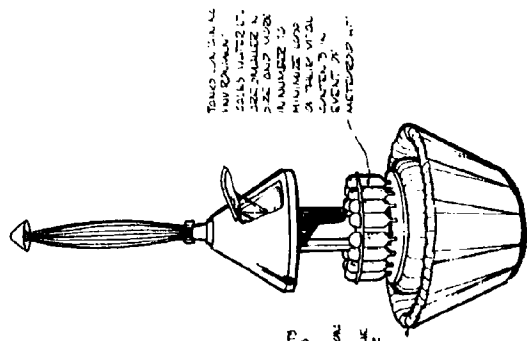

THIS IS THE
 THE SKIRT
 IS MADE OF
 220 MILITARY
 220 MILITARY
 IN AN AREA OF
 2. THE SKIRT
 IS MADE OF
 220 MILITARY

WITH JORDAN SEGMENTS
 SHOWN - EXPLOSIVE BOLTS
 MAY BE ACTIVATED
 THE INFLATOR PORTAL
 OF THE SKIRT IS
 THIS UNCOILS AS THE
 FLUID SECTIONS LOWER

ALUMINUM
 CAN DOME



FLUID WITH LUNAR FLUID

COULD SCARCITY OF OXYGEN
 BODY ARE USED AS STORAGE
 PRIMARY FLIGHT AND SECONDARY
 FLIGHT FUNCTION IS
 SECONDARY EMERGENCY SHIELDS

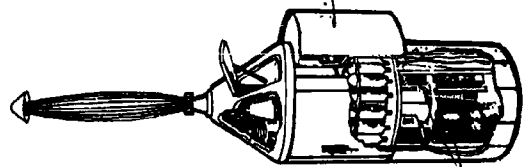

SPARE CONCENTRIC POINT
 BEING STRAIN FROM
 FROM JUDGE BOLTS

CENTER OF GREE PERIODS
 HOLDING SHIRT FOR
 CENTERING ELEVATOR
 CENTERING ELEVATOR
 STORAGE AREA FOR JUDGE
 BOLTS DURING JUDGE
 TRAVEL

ELEVATOR-OR-LACK CAPABLE OF
 JUMPING AT ENTRANCE-EXIT
 POSITION.
 AS CAPABLE OF MOVING, IT BECOMES
 A CENTERING ELEVATOR
 OF CENTERING ELEVATOR
 OF CENTERING ELEVATOR
 THEN DELIVERED CENTERING
 TO LUNAR AREA (BOTTOM)

HIGH PRIORITY
 CASED STRIP
 HERE FOR HIGH
 PRIORITY
 PRIMARY FLIGHT

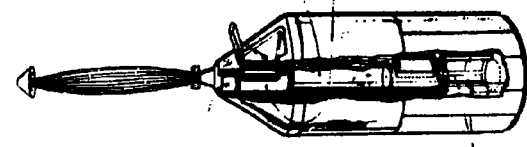

RELOCATE BACK
 CONTAINS HEAVY
 CHIPPING FOR
 AIR-LINK SHIRT

ELEVATOR
 TRAVEL (BOLTS)

GUIDE BOLLS
 FOR ELEVATOR
 POSITION

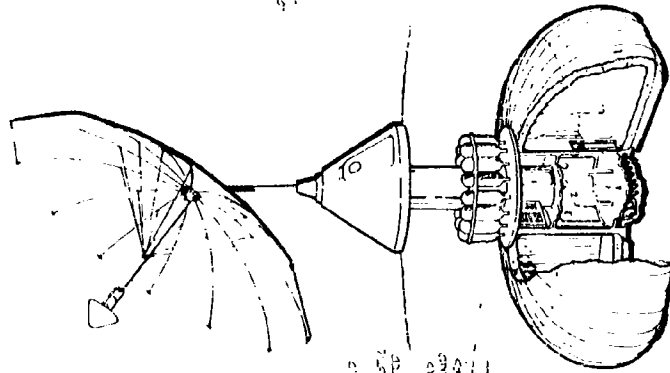

WALLS OF LIGHT
 AT THE POINTS
 INTERSECTING
 WATER WALLS
 THE PLASTIC FORMS
 AND RODS ARE
 THE NORMAL MASS
 ARE ALIGNED
 OUTSIDE IN THE
 HOUSE IN THE
 HOUSE

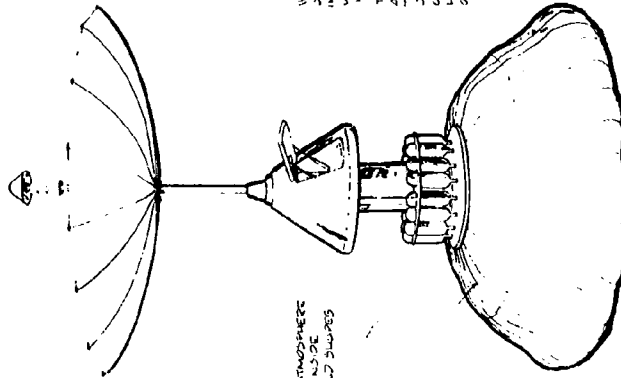

ARTIFICIAL ATMOSPHERE
 INTRODUCED INSIDE
 AIRWAYS AND SHIPS
 DUCTS

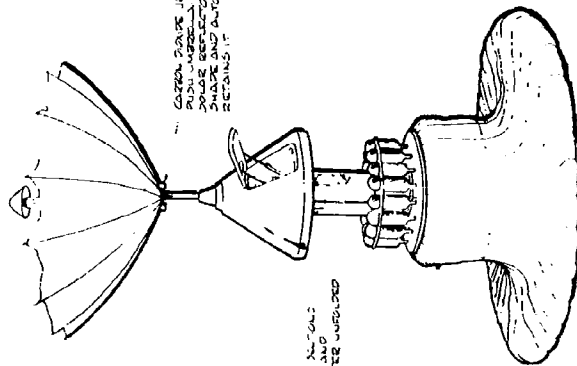

CONCRETE FORMS
 PUSH WATER INTO
 SHIP REFLECTOR AND
 SHIP AND AUTOMATICALLY
 RETURNS IT

FOR NO
 SHIP REFLECTOR

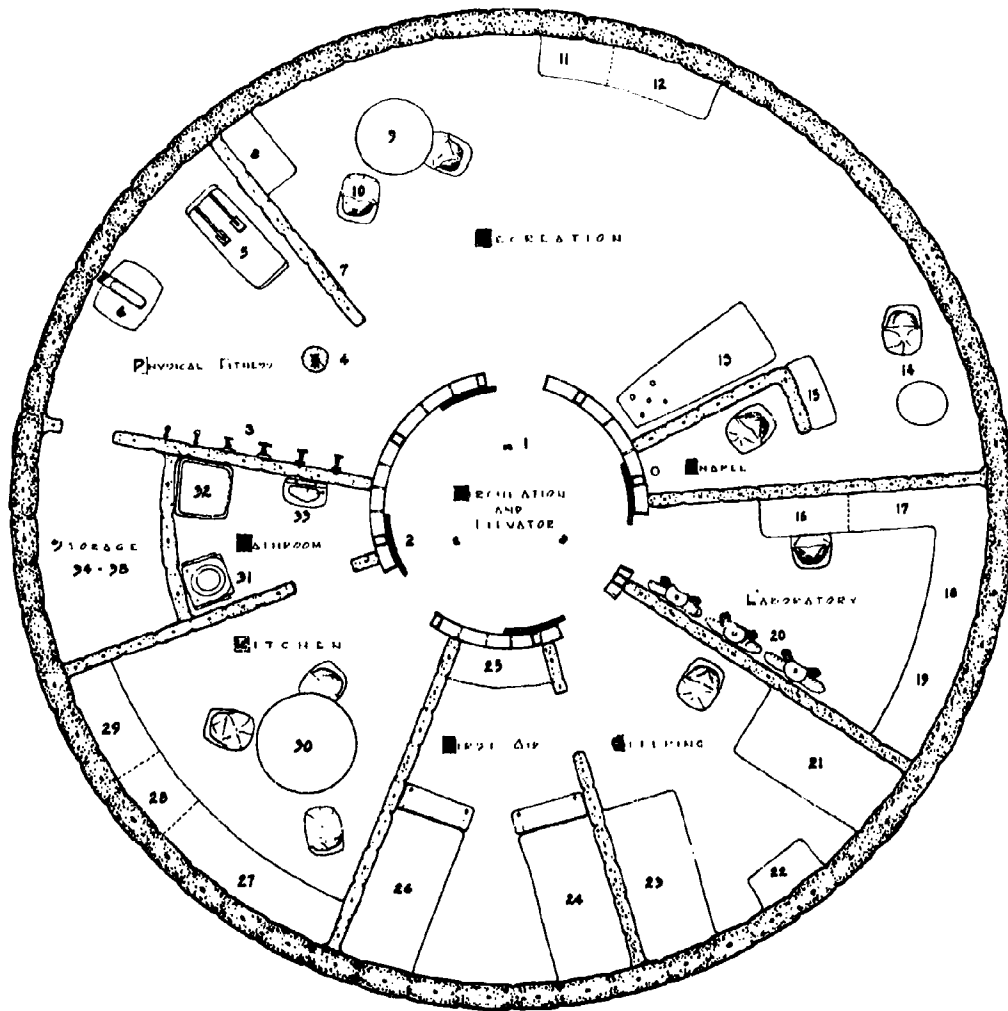

■ CIRCULATION AND ELEVATOR AREA
 1 VERTICAL GUIDED FOR ELEVATOR
 2 PRESSURE SEALED SLIDING DOORS

□ PHYSICAL FITNESS
 3 WALL MOUNTED SPRINGS
 4 PUNCHING BAG
 5 LEG EXERCISER
 6 BACK EXERCISER

■ RECREATION
 7 WALL GAME
 8 GAME STORAGE
 9 TABLE
 10 CHAIRS
 11 MUSIC AND VISUAL RECREATION
 12 CRAFT AND HOBBIES
 13 FLOOR GAME
 14 READING AREA
 15 BOOK STORAGE

■ CHAPEL
 □ LABORATORY
 16 COMMUNICATIONS
 17 BIOLOGY AREA
 18 LUNAR MINERAL ANALYSIS
 19 RECONNAISSANCE
 20 PRESSURE UNIT STORAGE

□ SLEEPING
 21 SINGLE BUNK STORAGE BELOW
 22 PERSONAL STORAGE
 23 DOUBLE BUNK

■ FIRST AID
 24 SINGLE BUNK WITH END SHELF
 25 MEDICAL SUPPLY STORAGE
 26 SINGLE BUNK

□ KITCHEN
 27 LINN STORAGE
 28 VENTILATION
 29 WATER AND HEATING UNIT
 30 TABLE

■ BATHROOM
 31 WATER CLOSET
 32 STEAM SHOWER UNIT
 33 PLASTIC WATER BASIN

□ STORAGE
 34 WATER PURIFICATION
 35 FILTER
 36 PUMP
 37 WATER AND GAS STORAGE
 38 REPAIR EQUIPMENT AND PARTS

□ MOVABLE FURNITURE

□ FURNITURE ATTACHED TO SHELTER

SQUARE FOOTAGE BY ROOM

CIRCULATION	78
PHYSICAL FITNESS	118
RECREATION	140
CHAPEL	18
LABORATORY	78
SLEEPING	105
FIRST AID	98
KITCHEN	130
BATHROOM	74
STORAGE	40
TOTAL AREA	1043
TOTAL VOLUME	12608

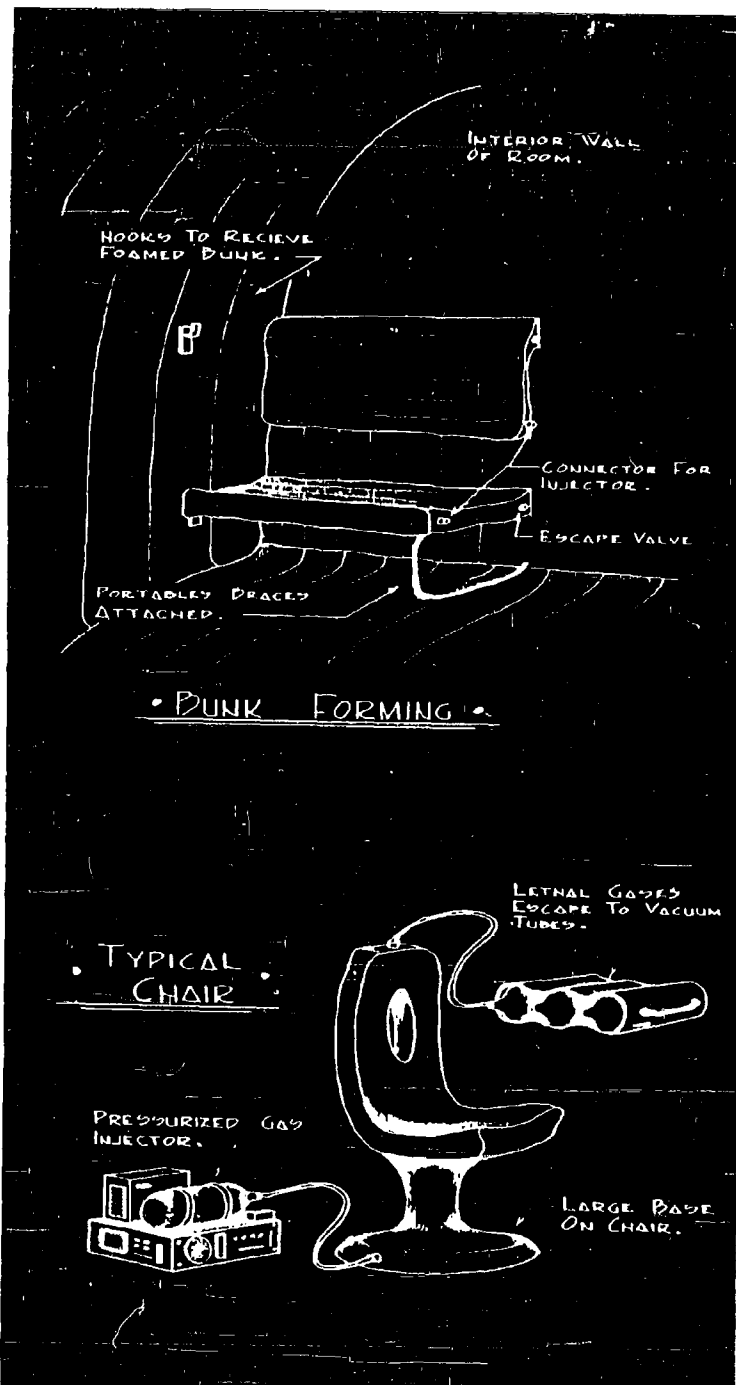

VERTICAL GAS FLOW

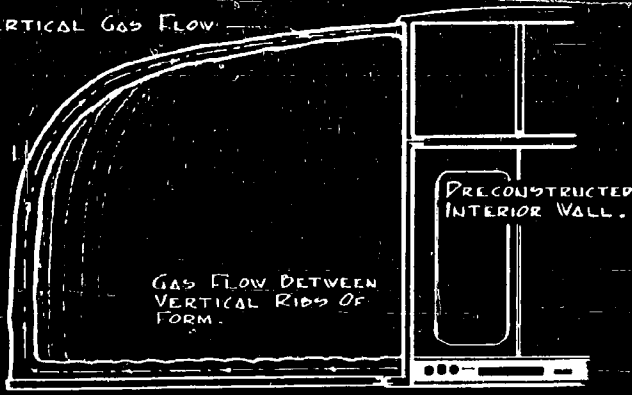

GAS FLOW BETWEEN VERTICAL RIBS OF FORM.

PRECONSTRUCTED INTERIOR WALL.

• SECTION SHOWING GAS FLOW •

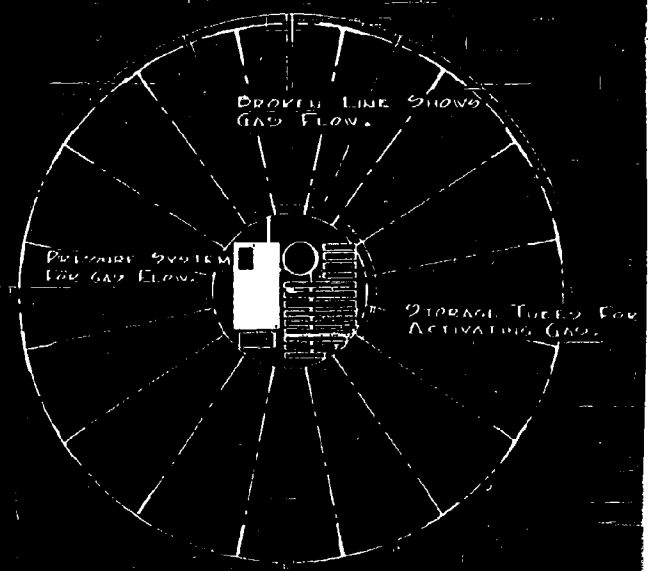

BROKEN LINE SHOWS GAS FLOW.

PRESSURE SYSTEM FOR GAS FLOW.

STORAGE TUBES FOR ACTIVATING GAS.

• PLAN SHOWING GAS FLOW •

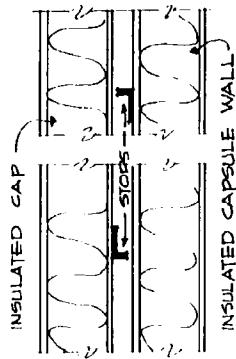

CAP IN LAUNCH POSITION
SCALE - A

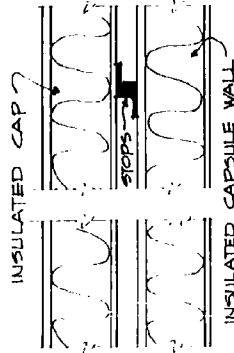

CAP IN OPEN POSITION
SCALE - A



SCALE - A

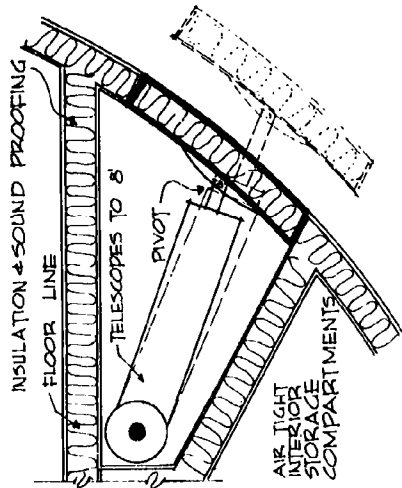

FOOTING DETAIL
SCALE - B

NOTE:
MOVABLE CAP WILL BE SO LUBRICATED THAT DURING OPENING PROCESS IT WILL NOT FUSE TO CAPSULE. CAP WILL BE OPERATED ELECTRICALLY FROM PANEL LOCATED OUTSIDE ON CAPSULE.
CAP WILL BE LOCKED TO CAPSULE DURING LAUNCH AND LANDING. LOCKS WILL BE RELEASED ELECTRICALLY AFTER PLACING IN POSITION.
TO FUSE STOPS TOGETHER AND CREATE AIRTIGHT SEAL, A SEALANT WILL BE PLACED BETWEEN STOPS AND ELECTRICALLY CHARGED TO AID IN FUSING.



SCALE - B

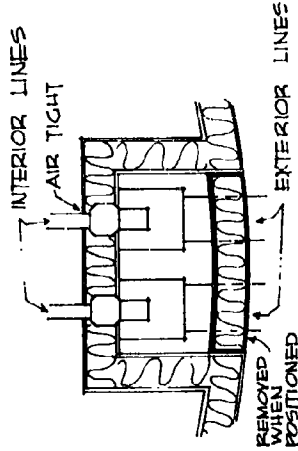

HORIZONTAL SECTION
SCALE - B

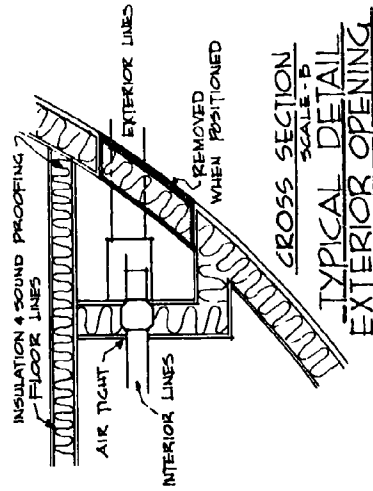

CROSS SECTION
SCALE - B
TYPICAL DETAIL
EXTERIOR OPENING

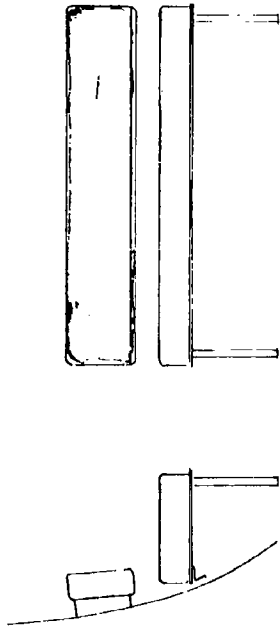

COUCH

SECURED TO CAPSULE WALL BY ANGLE LEGS AND SUPPORTS TO BE OF ALUMINUM.

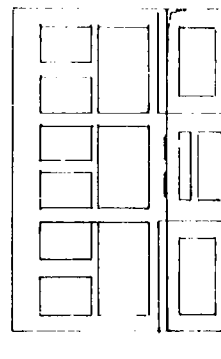

FOOD CENTER

COMPACT UNIT CONTAINS FOOD, FREEZER AND STORAGE, PREPARATION CENTER, AND WATER.

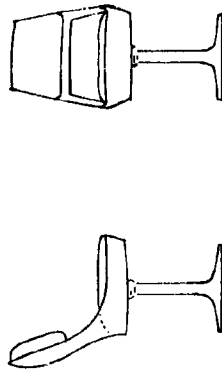

AUX. CHAIRS

CHAIR TO BE OF .063 ALUMINUM SHEET WITH FABRIC SEAT AND BACK REST. 3 UNITS TO BE SECURED DURING FLIGHT.

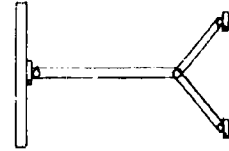

TABLE

PIVOT JOINTS ALLOW UNIT TO BE COLLAPSED DURING FLIGHT & WHEN NOT IN USE

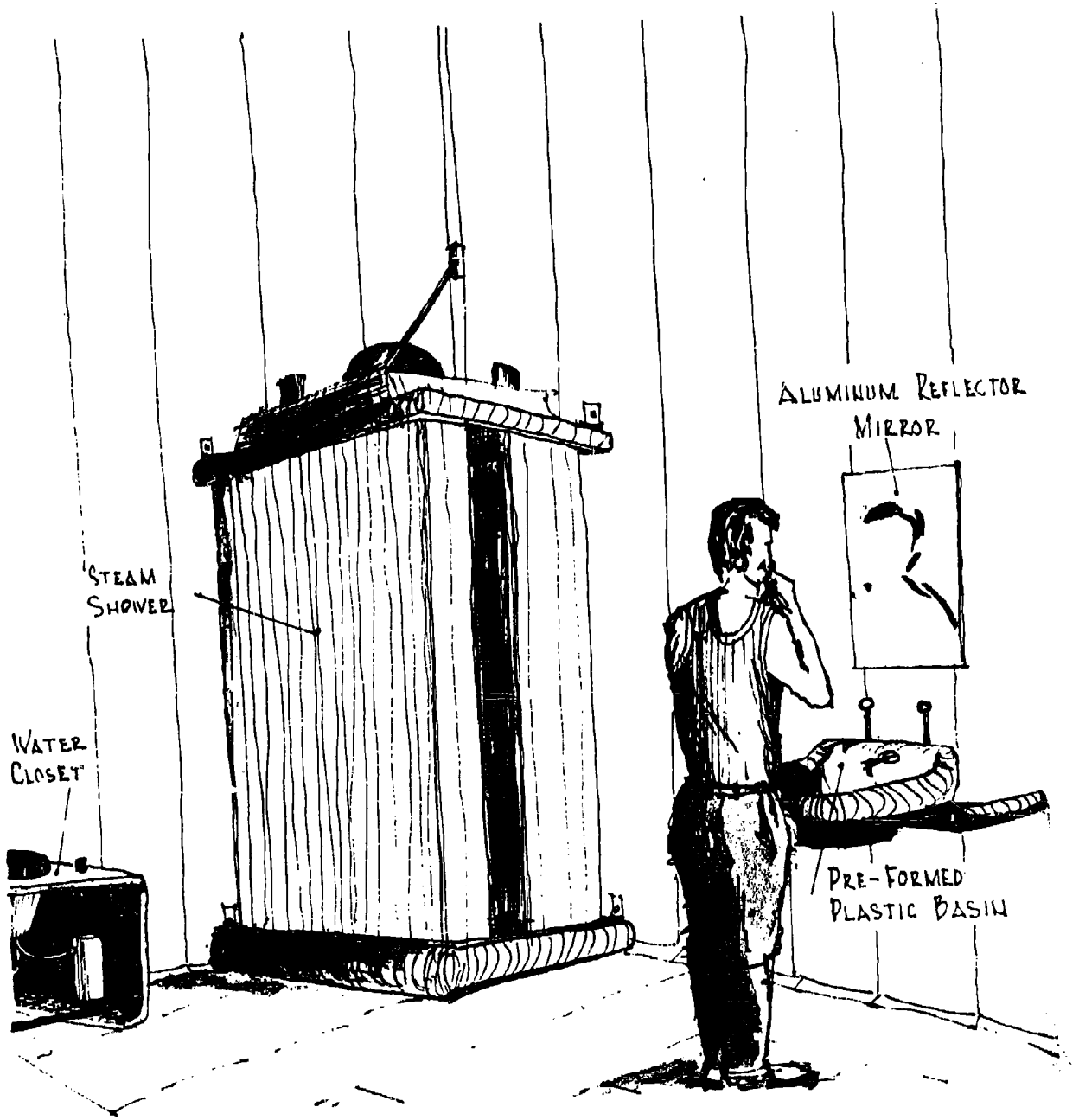

WATER
CLOSET

STEAM
SHOWER

ALUMINUM REFLECTOR
MIRROR

PRE-FORMED
PLASTIC BASIN

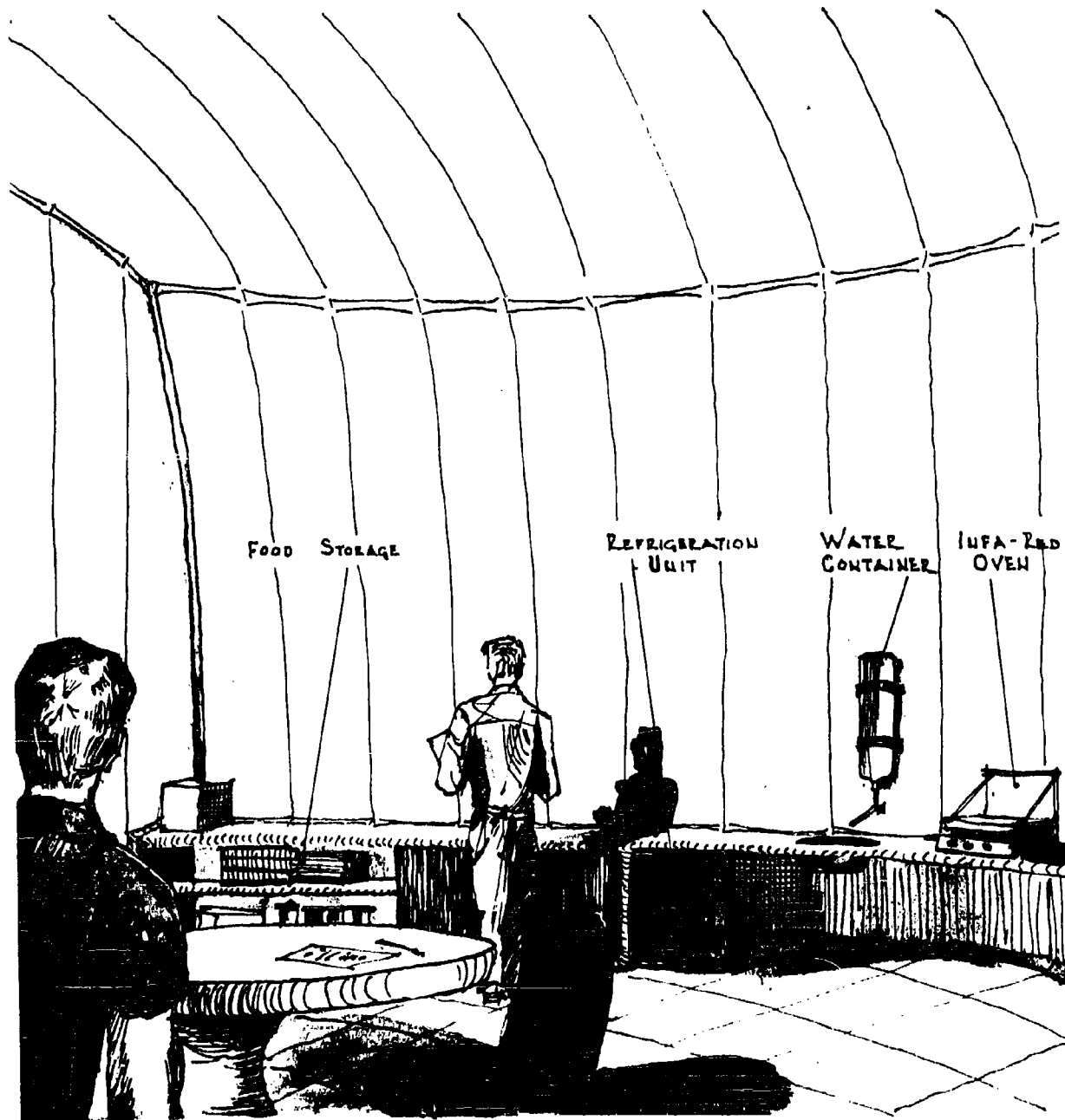

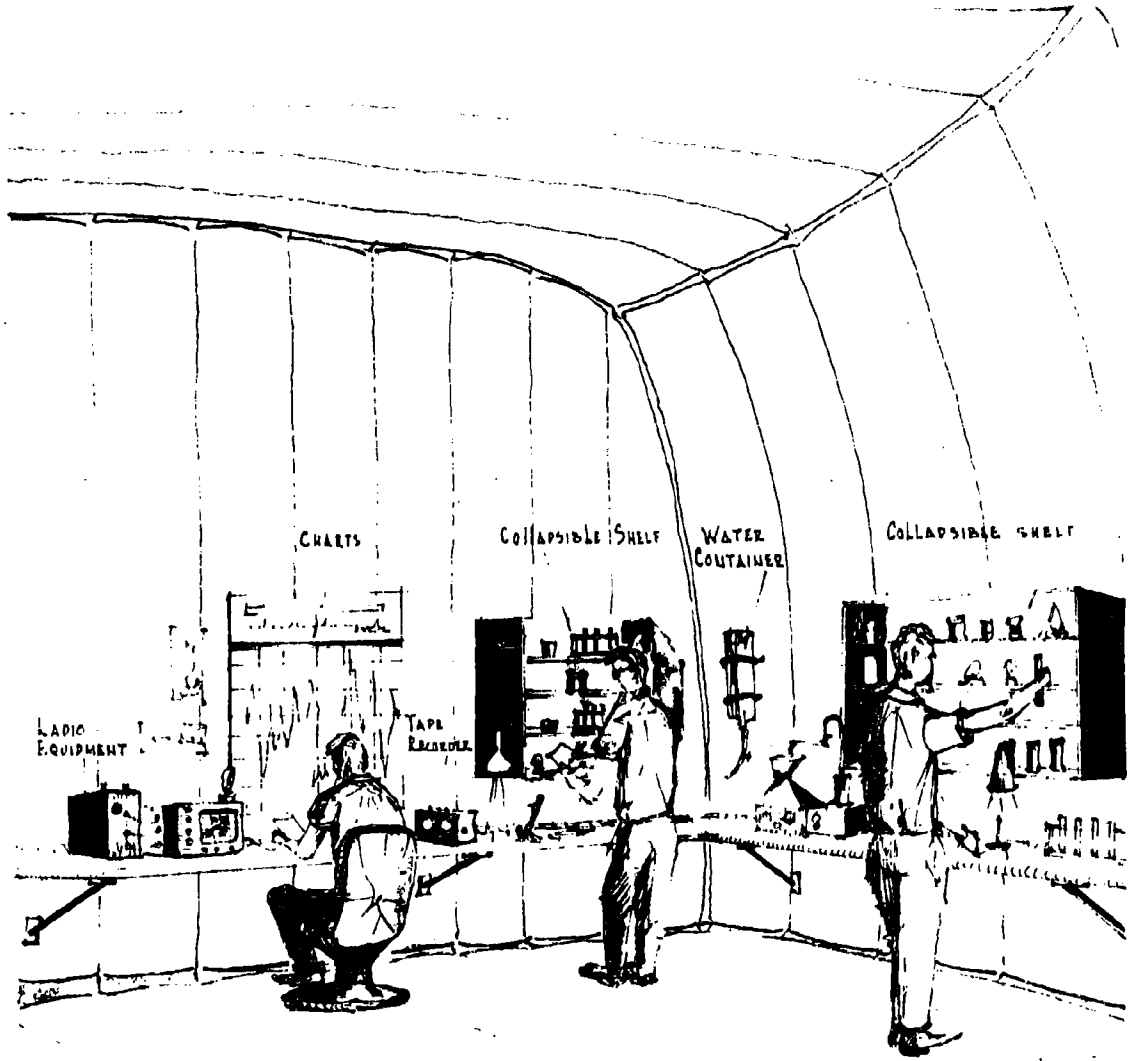

COMMUNICATIONS

BIOLOGY

LUNAR MINERAL ANALYSIS

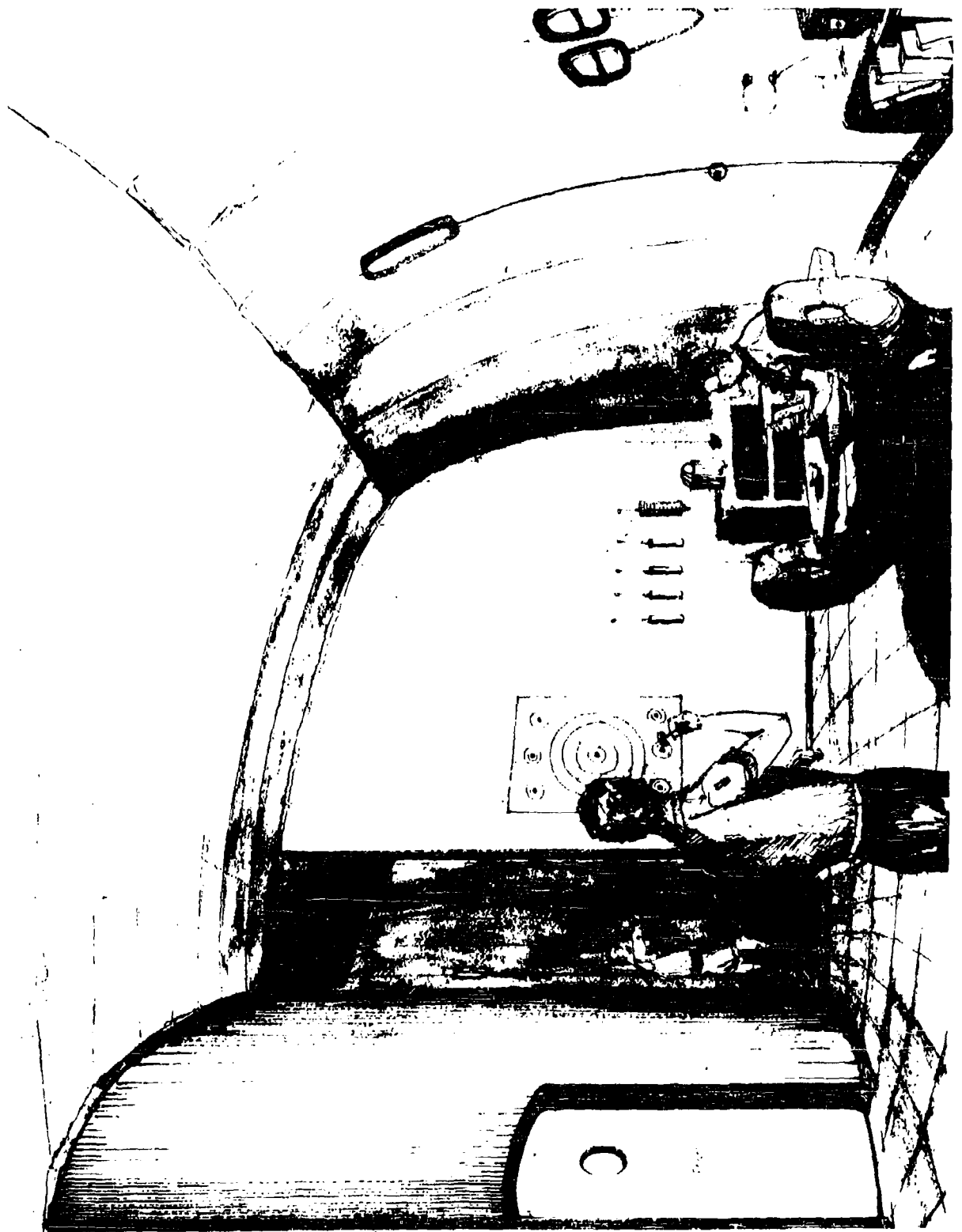

LUNAR SHELTER CONCEPTS

H. Goerke,	Ind. Des., '64
H. Rominger,	Arch., '64
J. Buchman,	Ind.Des., '63
J. Helgeson,	Arch., '64
J. Blackwood,	Arch., '64

1. DESIGN PHILOSOPHY

The philosophy involved in designing a lunar shelter is little different than the philosophy involved in designing an earth structure. Lunar design is, however, much more limited. We are forced to reproduce the earth's atmosphere, provide for servicing; or in other words, build a self-sufficient structure in a completely alien environment.

We have attempted to make our shelter a pleasing living space and at the same time a compact, highly functional structure. We have attempted to present a design solution which is functional psychologically as well as mechanically.

2. PACKAGE & ERECTION TECHNIQUES

The structure is packaged within the required cylindrical volume: length of 35 feet, diameter of 14 feet. The package itself is split longitudinally into halves and utilized as an entry canopy at the two air locks. The exterior equipment is packaged within a second cylinder that is 4 feet in diameter and 22 feet in length. The cylinder fits through the central air lock and is anchored to one of the expandable entrance tube doors.

Steps in process of erection:

- a. The package is lowered from the rocket and positioned on a relatively smooth area by the vehicle.
- b. The exterior package is removed by the vehicle and placed near by.
- c. The cylinder is hydraulically leveled.
- d. The shelter is then expanded as follows:
 - (1) Cylinder is depressurized.
 - (2) Entry tubes and bottom of the cylinder are released.
 - (3) The shelter is repressurized slowly and allowed to expand. The exterior

equipment is pulled forward in one tube as the shelter expands.

(4) The shelter is depressurized.

(5) The floor is allowed to solidify, and the exterior equipment cylinder is removed by the vehicle.

e. The canopies are erected, and the conduit is laid for the exterior equipment.

f. The exterior equipment is erected, and the shelter is covered with lunar dust.

g. The interior furnishings and panels are put in place.

3. STRUCTURE & MATERIALS

The structure is essentially mechanical. The hinged joints would be under atmospheric conditions at times of expansion and then released in order to rigidize.

The interior panels are to be 3 inches thick porcelain enamel panels, perforated and insulated.

The floor is two layers of flexible plastic, reinforced with cables and foamed in place plastic between the two layers. The cables

would also act as spacers, insuring the proper degree of expansion. The exterior walls would be at least double thickness cavity walls to provide for perimeter heating and cooling.

The structure is made up of 3 transverse frames stabilized by the end air locks, the exterior skin and the floor.

4. FLOOR PLAN ANALYSIS

Structure and packaging have dictated to a great extent the layout of the plan. The living area of the structure has five major areas. The recreation area has the least necessity for built-in equipment, therefore, it is centrally located. All major equipment is built into the wall and ceiling cavities. The other four spaces (kitchen, sleeping, toilet and sick bay) relegate themselves to their positions due to their size. The primary air lock and the lab areas are adjacent, thereby placing the maintenance and scientific aspects of the shelter in one area. A secondary recreation and exercise area is included in the lab section in order to isolate potentially noisy activities. The acoustically-treated partition walls and resilient flooring system should decrease the transmission of sound and vibration to an acceptable level. The panels would act in the same manner to stop reverberation.

5. ENVIRONMENTAL PROTECTION

The structure is covered with 10 feet of lunar dust to protect the men and ship from meteorites and harmful amounts of solar radiation.

The structure maintains an atmospheric pressure of 10 psi.

The air is dehumidified, filtered, deodorized, regenerated and then recirculated.

Temperature is maintained by radiating excess heat (black body) during the day cycle and utilization of the energy stored by the solar collector during the night cycle.

The shelter is divided into two airtight sections, each capable of maintaining pressure and temperature until repairs could be made. Each section is serviced by an exterior air lock. Water, air, etc. are compartmented so that a failure of any one compartment would not seriously affect the total supply. Extra space suits are stored in the top cavity of the emergency airlock for repair work. The airlocks act as decontamination points.

6. INTERIOR FURNISHINGS & EQUIPMENT INTEGRATION

All interior furnishings, with the exception of a few chairs, are built into the walls. The panels fit against the exterior walls during flight and can be easily folded out after expansion of the structure.

The mechanical equipment is built into the ceiling cavities. All generators, compressors, etc., are to be suspension-mounted to decrease vibration. Tables and couches fold or slide out of the panels and walls.

7. STATISTICAL INFORMATION

a. Volume and area by section:

Laboratory #1	760 cu. ' 39 sq. '
Laboratory #2	760 cu. ' 39 sq. '
Main Recreation	1,010 cu. ' 112 sq. '
Secondary Recreation	810 cu. ' 90 sq. '
Kitchen	600 cu. ' 42 sq. '
Toilet	350 cu. ' 12 sq. '
Sleeping	600 cu. ' 42 sq. '
Sick Bay	350 cu. ' 14 sq. '
Ceiling (Mechanical Equipment)	1,085 cu. ' - sq. '
Area for Exterior Gear	360 cu. ' 40 sq. '
Air Locks (Mechanical Equipment)	672 cu. ' - sq. '
Extra Space Suit Storage	224 cu. ' - sq. '
Passage and Decontamination	236 cu. ' 32 sq. '
TOTAL	6,635 cu. ' 464 sq. '

b. Major Equipment Included:

- (1) Water storage and system for reprocessing wash water, system for heating and cooling water and system for recovering water from waste.
- (2) Air storage and system for purification, circulating, deodorizing, regenerating, heating, cooling, compressing, and maintaining the proper pressure of atmosphere.
- (3) Storage batteries and solar collector to provide energy. Electrical system to service stove, refrigerator, lights, radio, etc.
- (4) Heating and cooling system.

8. THEORETICAL ADVANTAGES OF THIS CONCEPT

- a. The structure requires no intricate exterior assembling.
- b. The structure is compact, requiring a minimum amount of power, and atmosphere.
- c. This concept could be used as a module by attaching similar shelters (groups of 4) at the expandable entry tube.

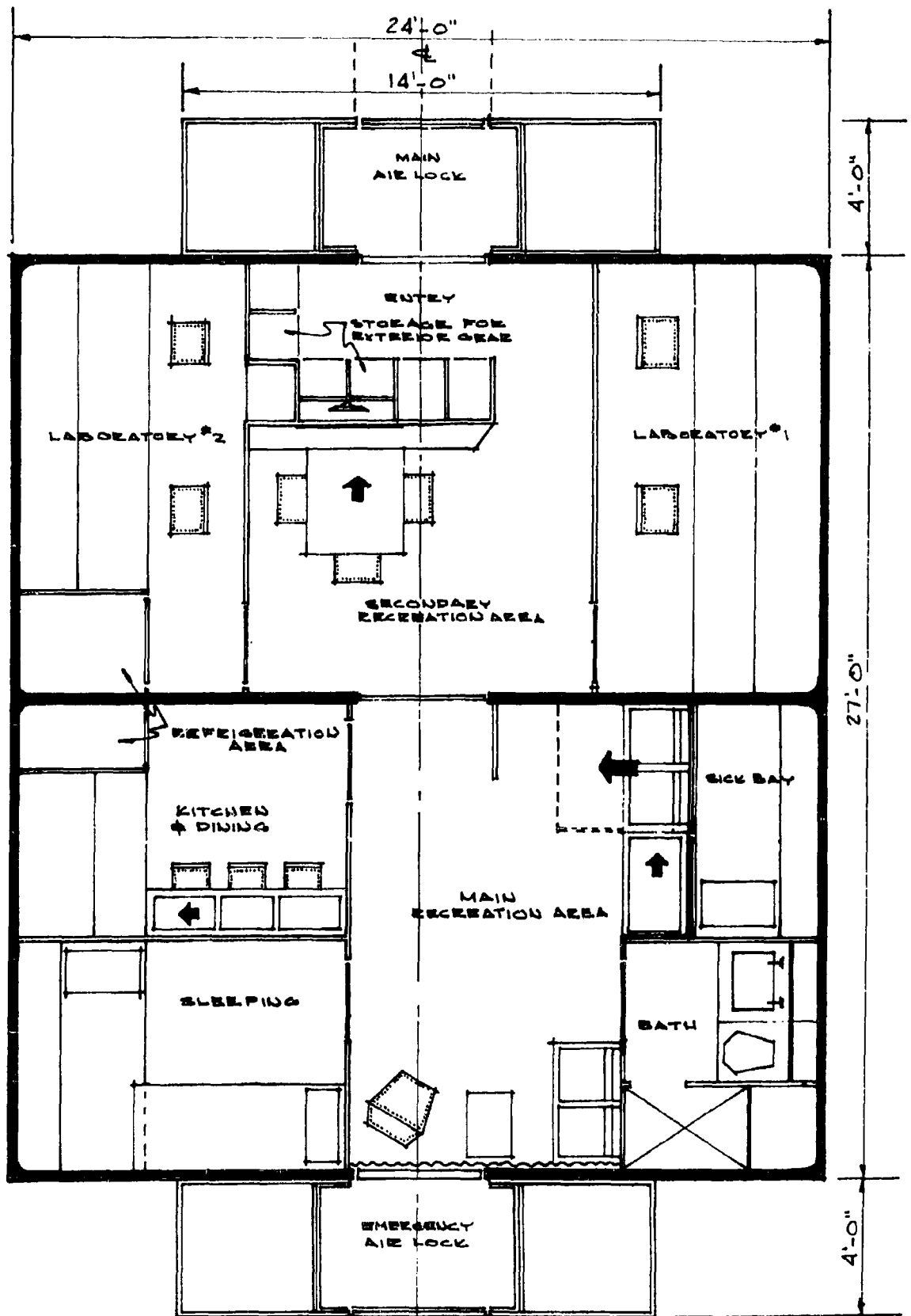

FLOOR PLAN

1/4" SCALE

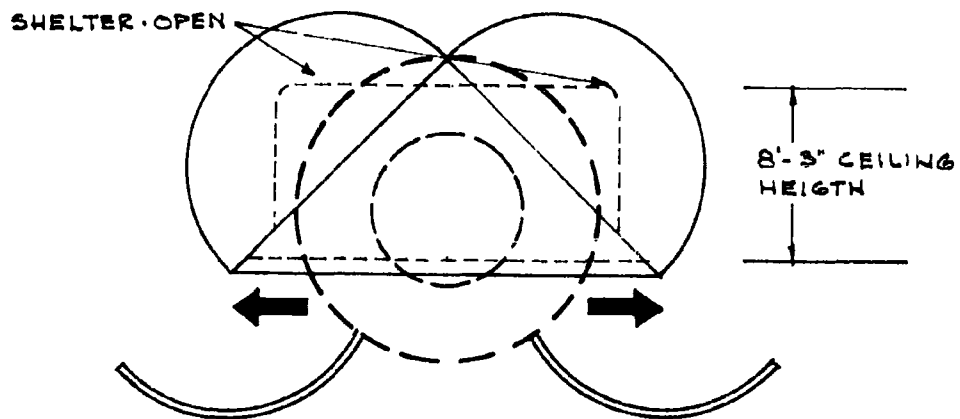
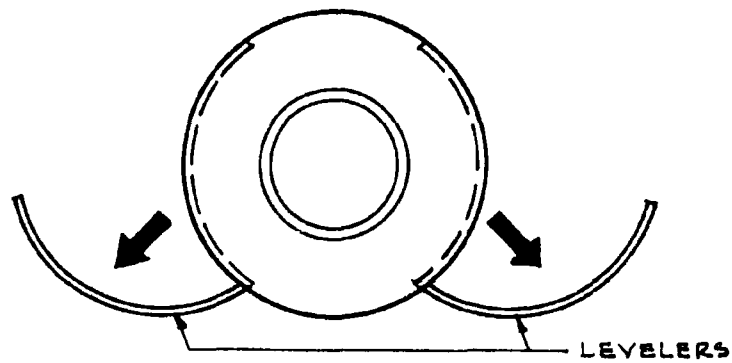
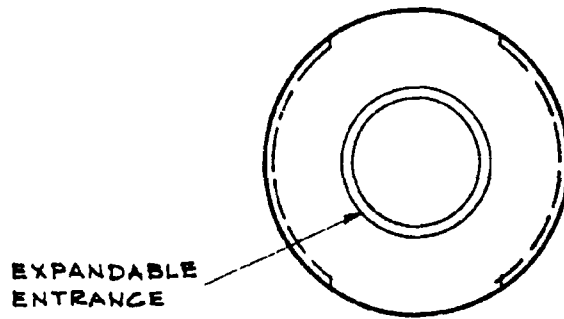

SHELTER OPENING

1/8" SCALE

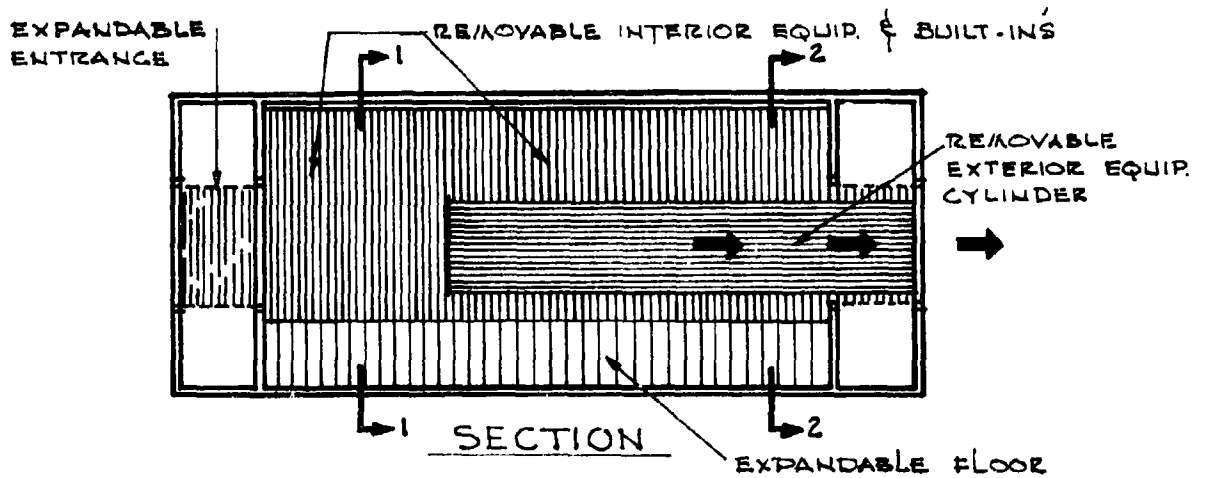
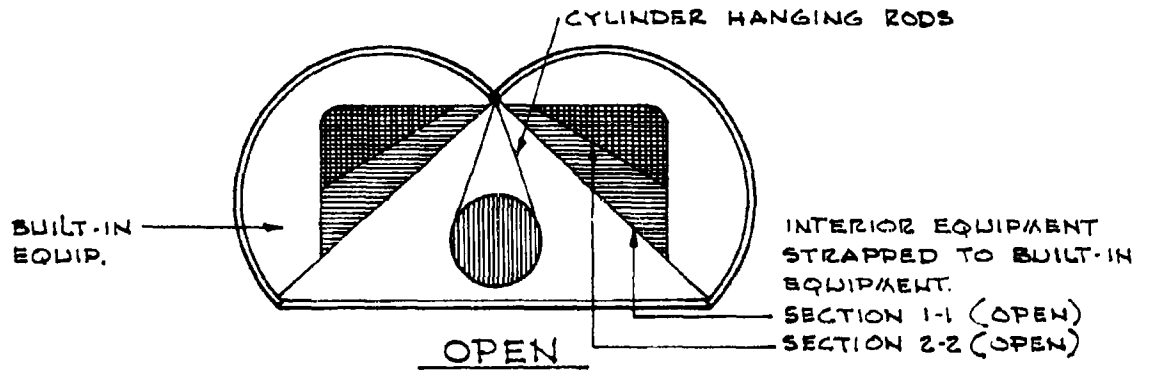
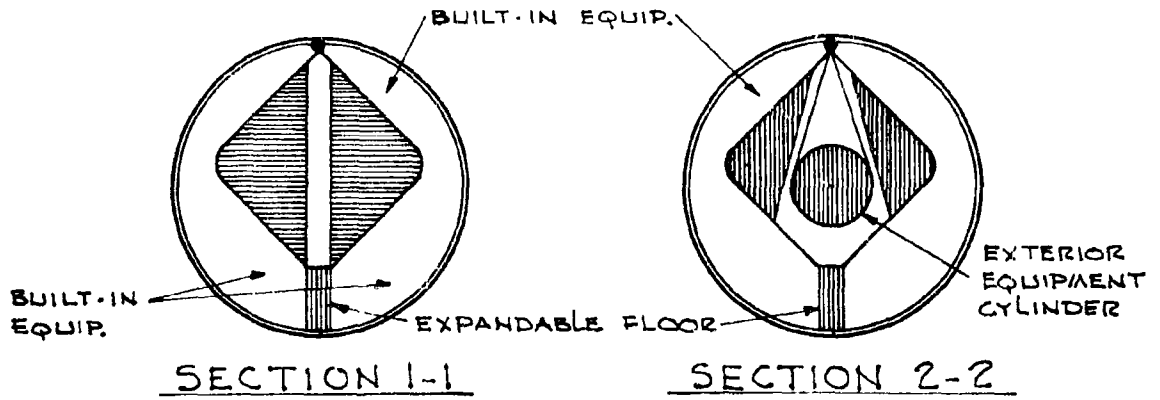

PACKAGING

1/8" SCALE

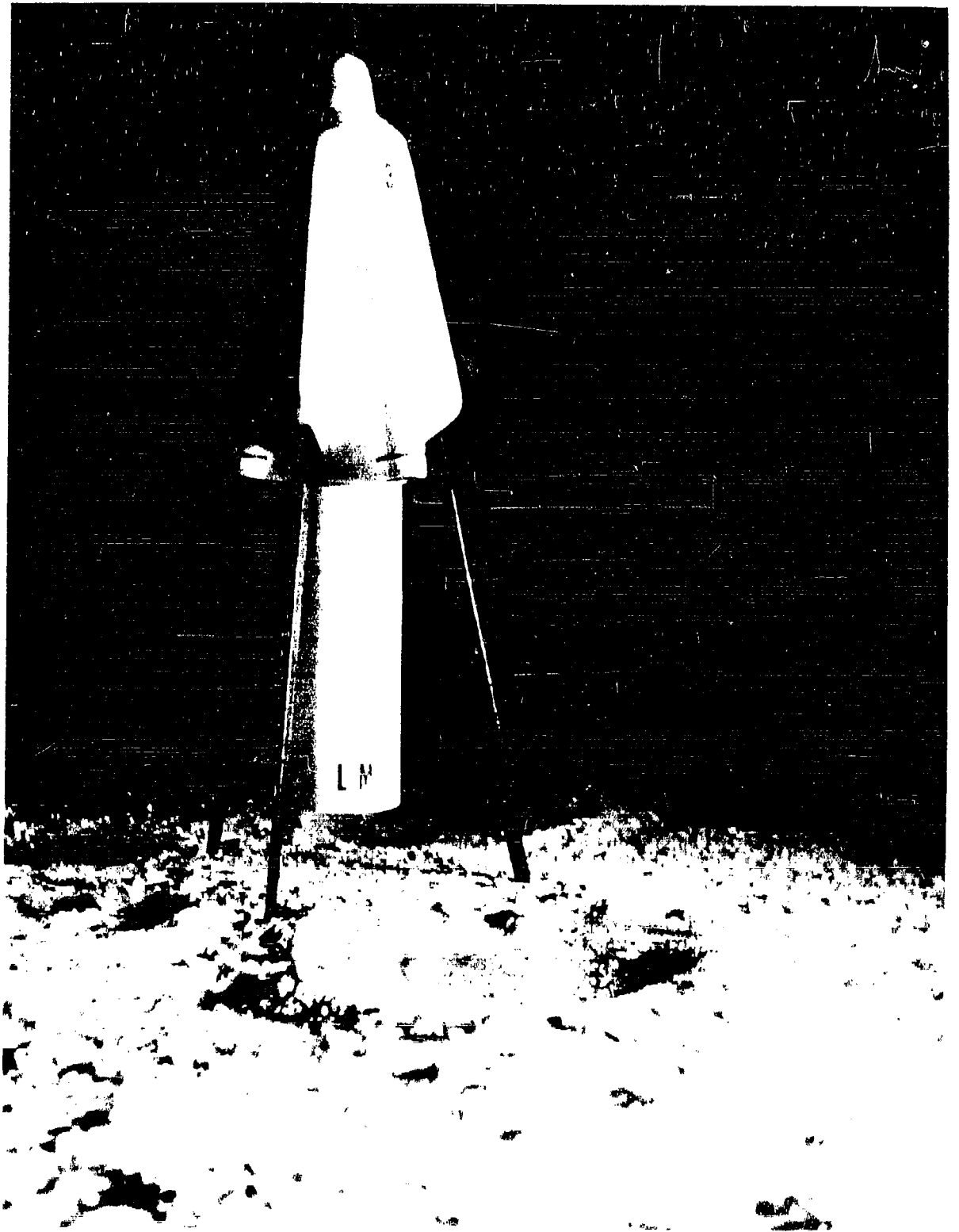

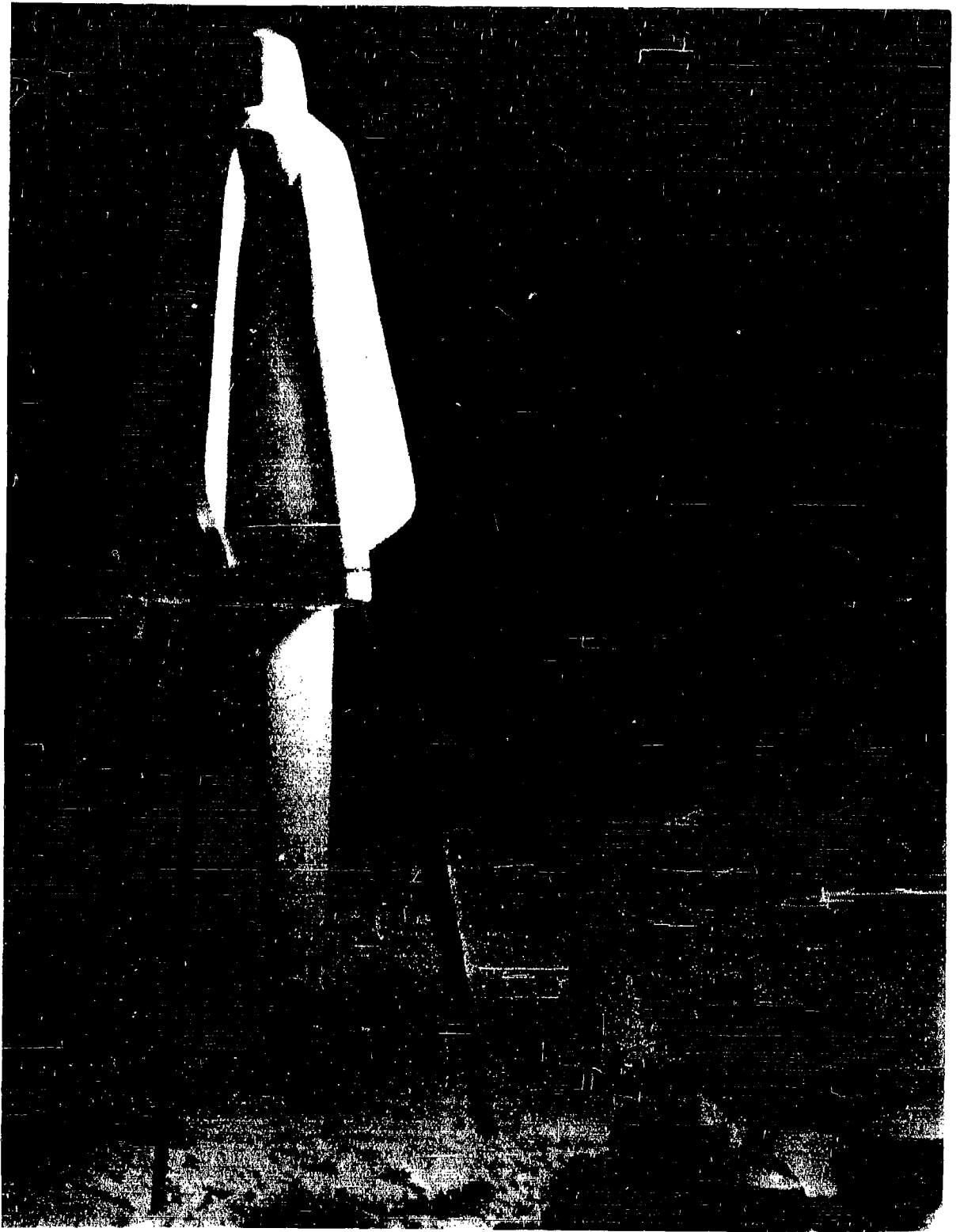

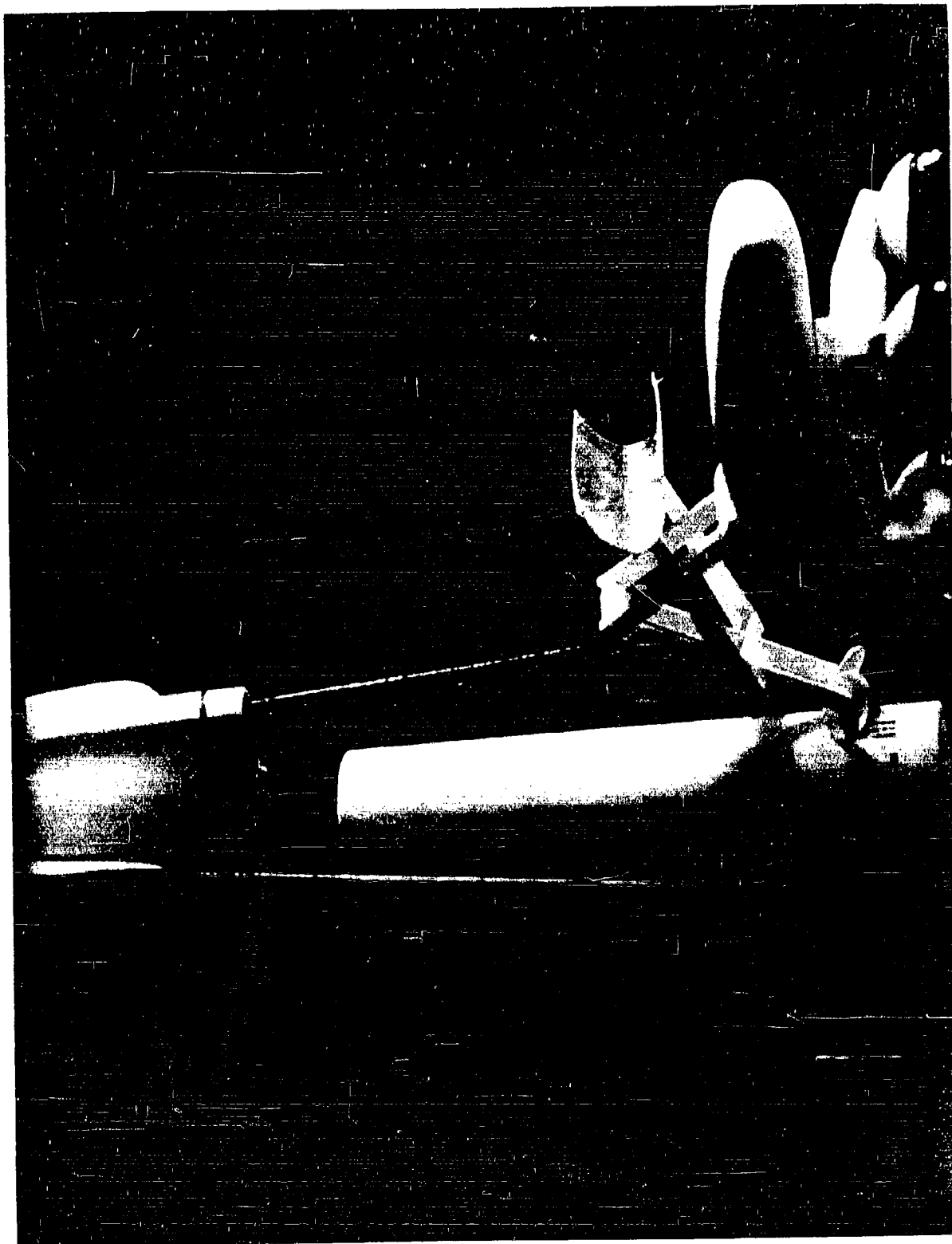

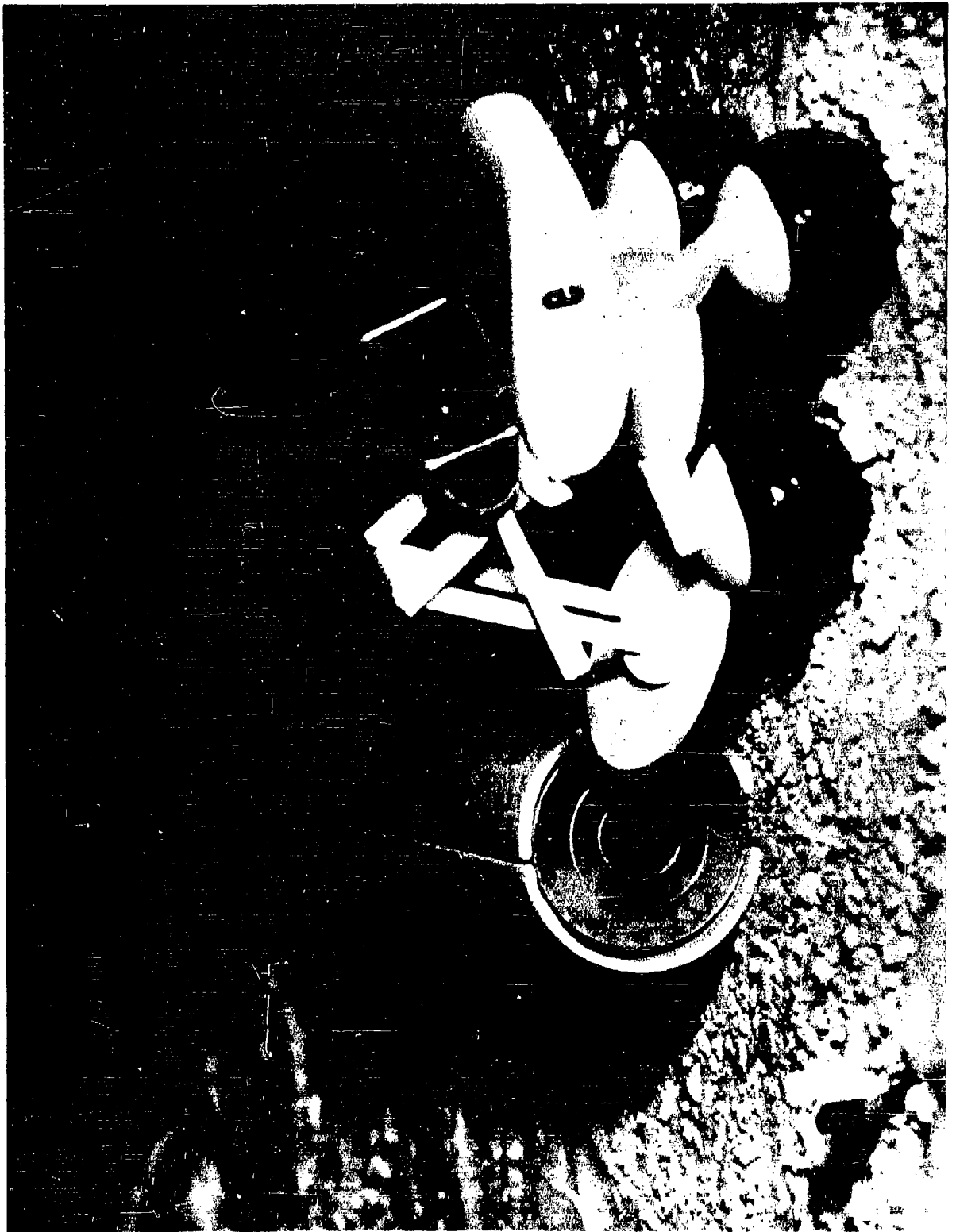







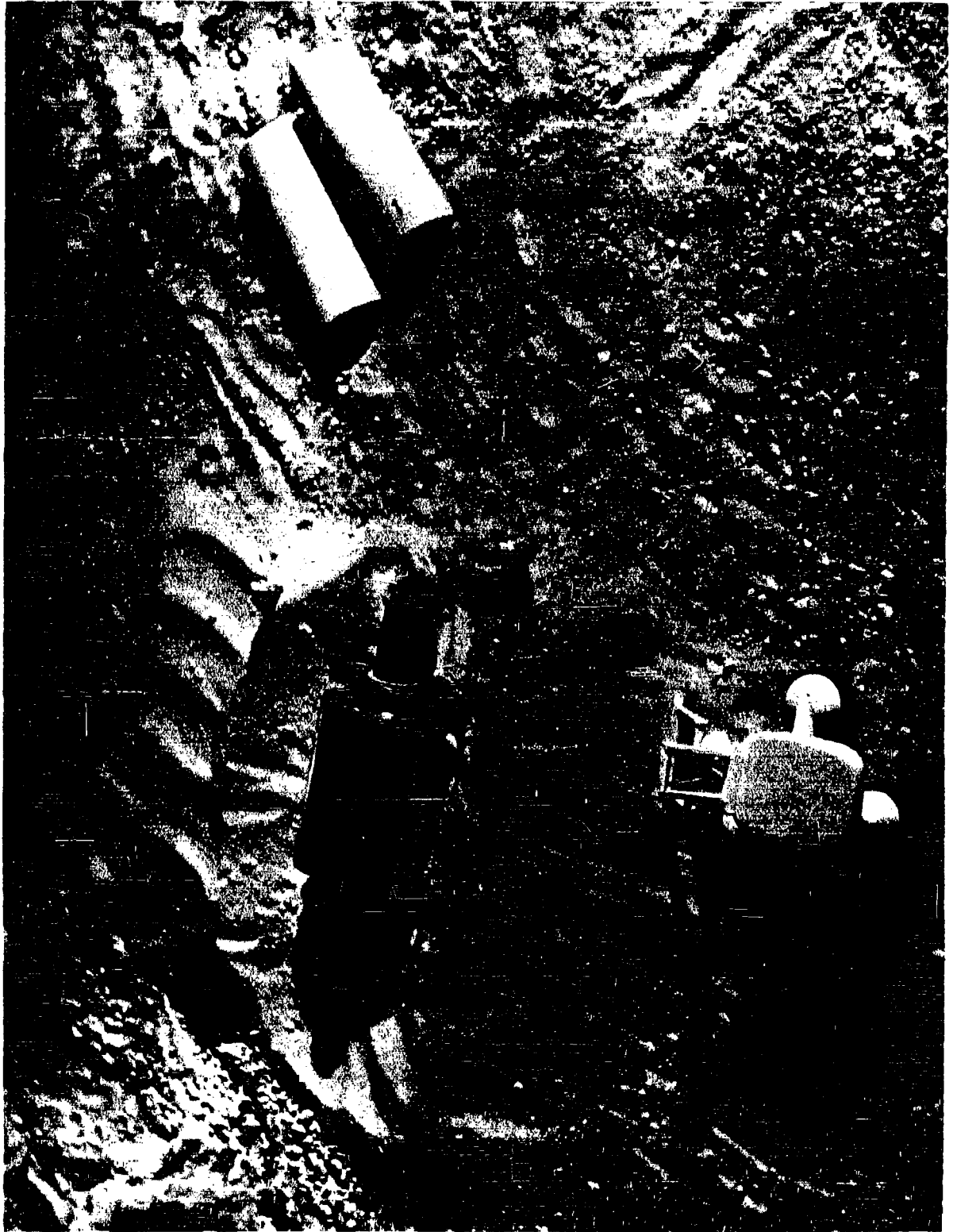



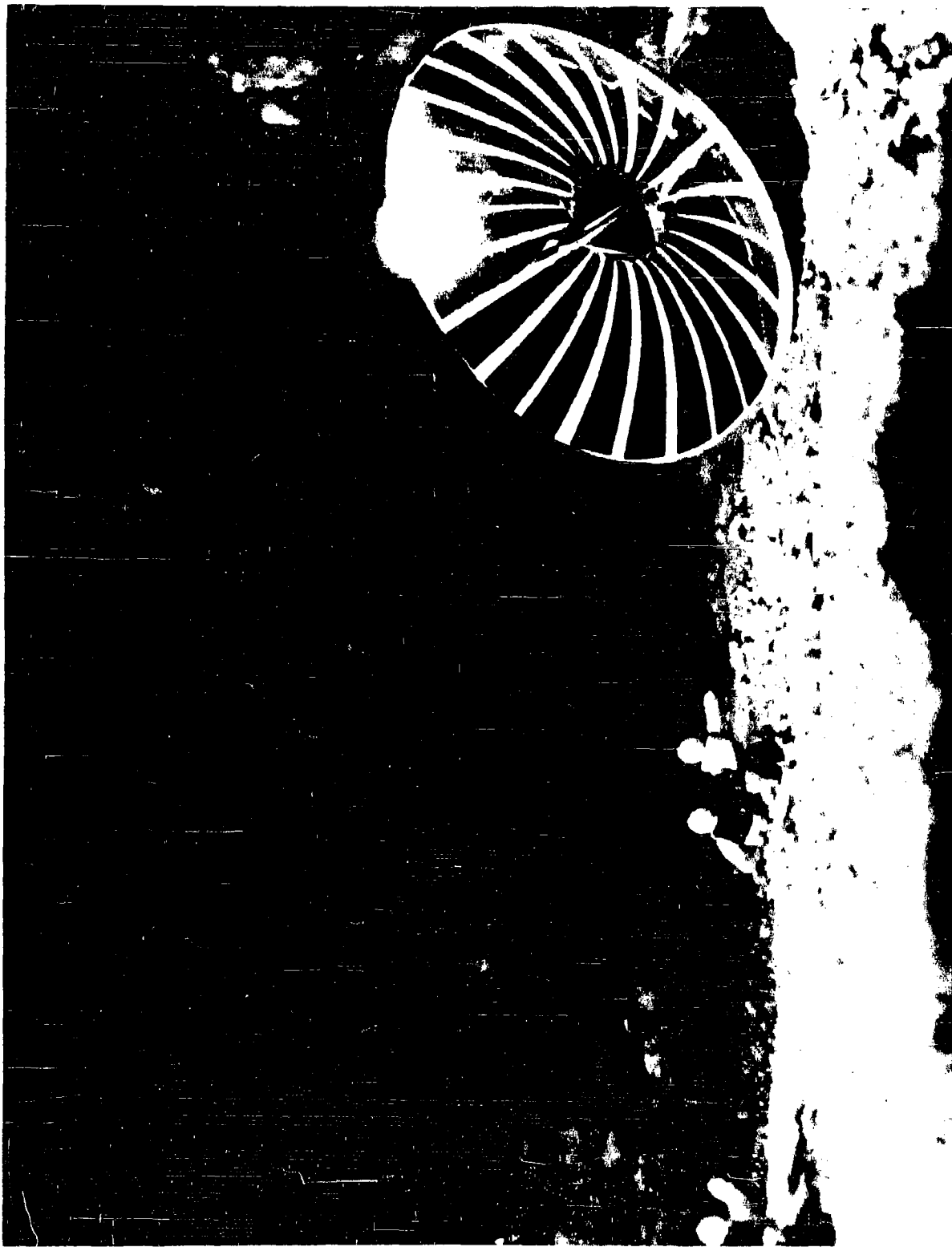

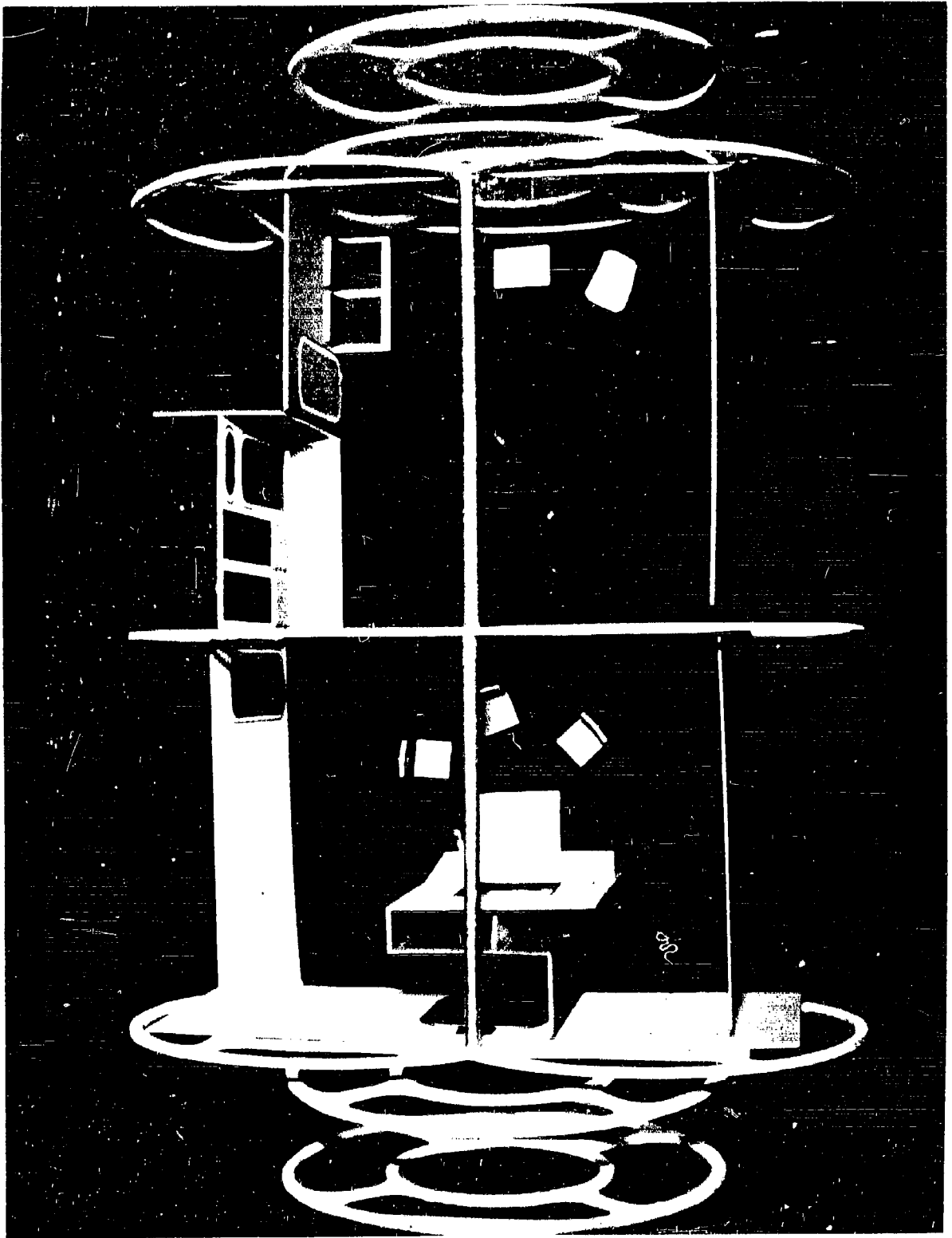

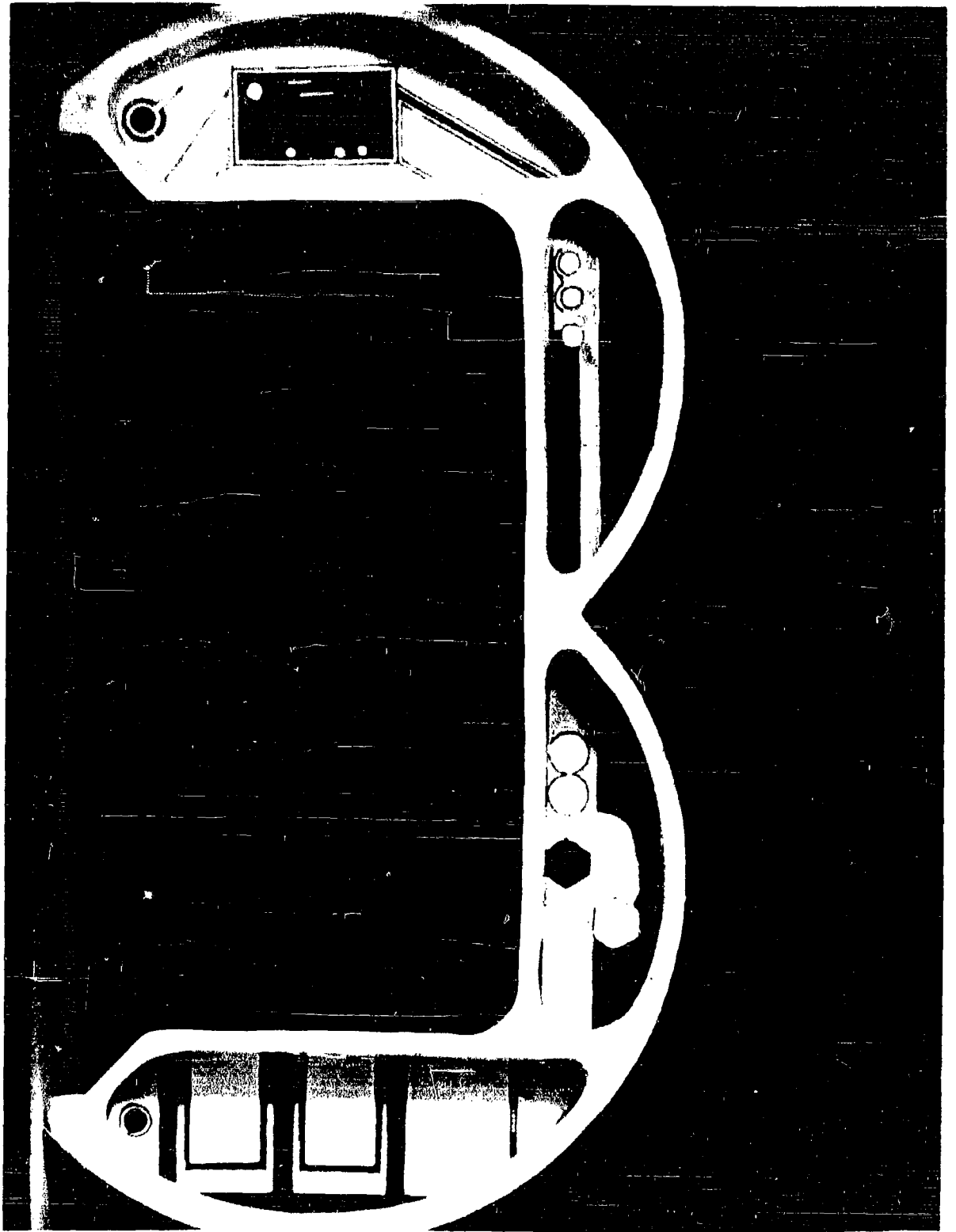

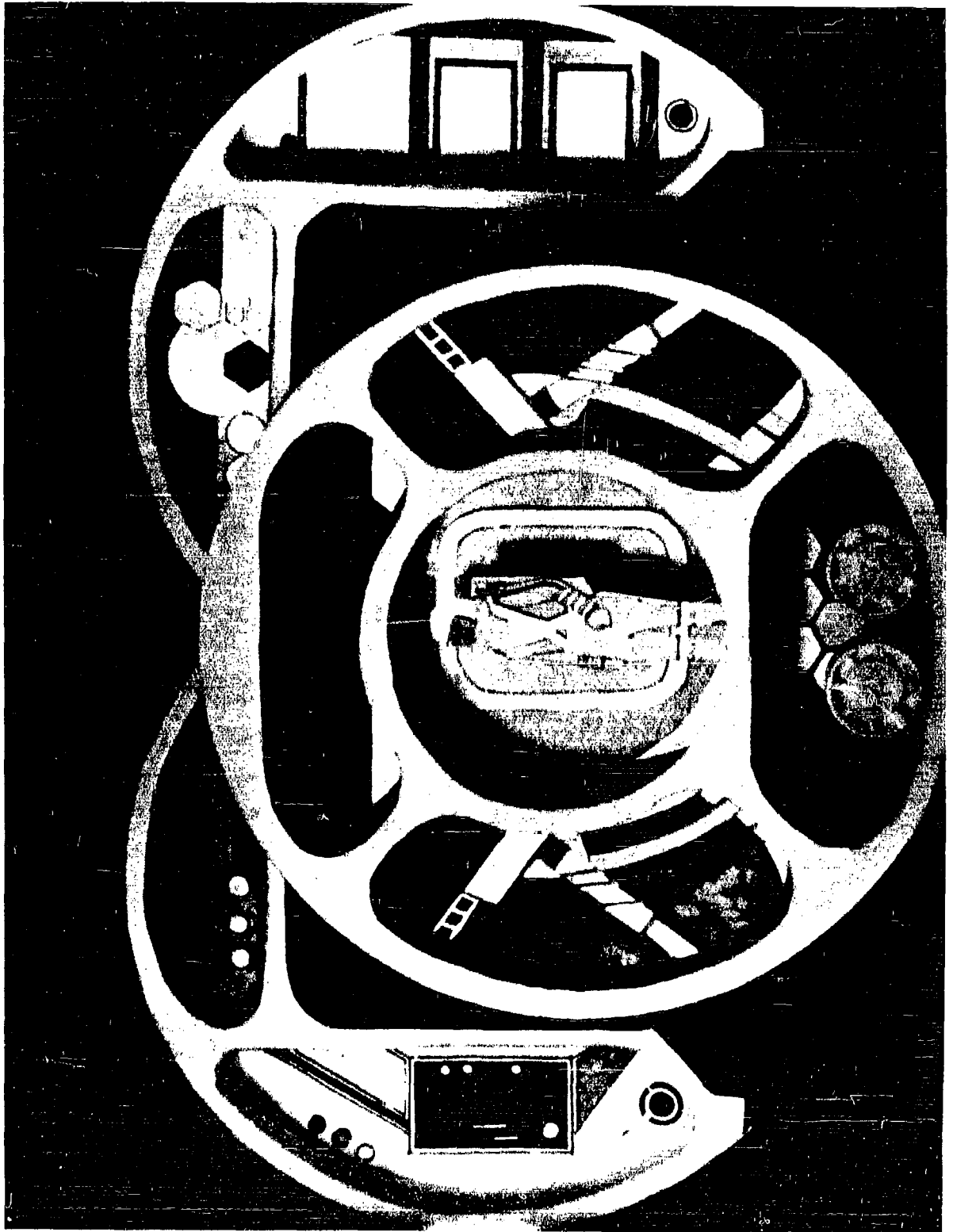

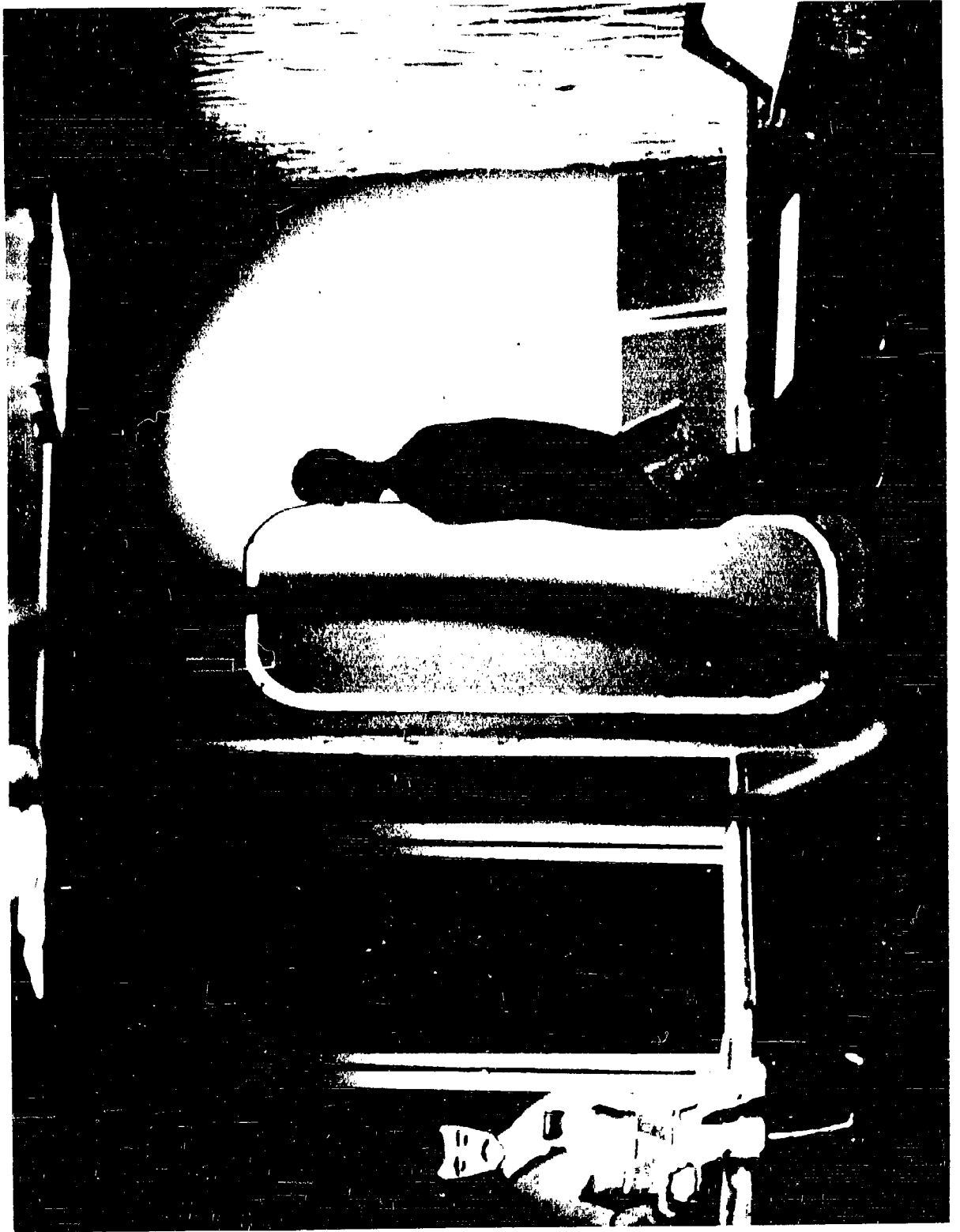

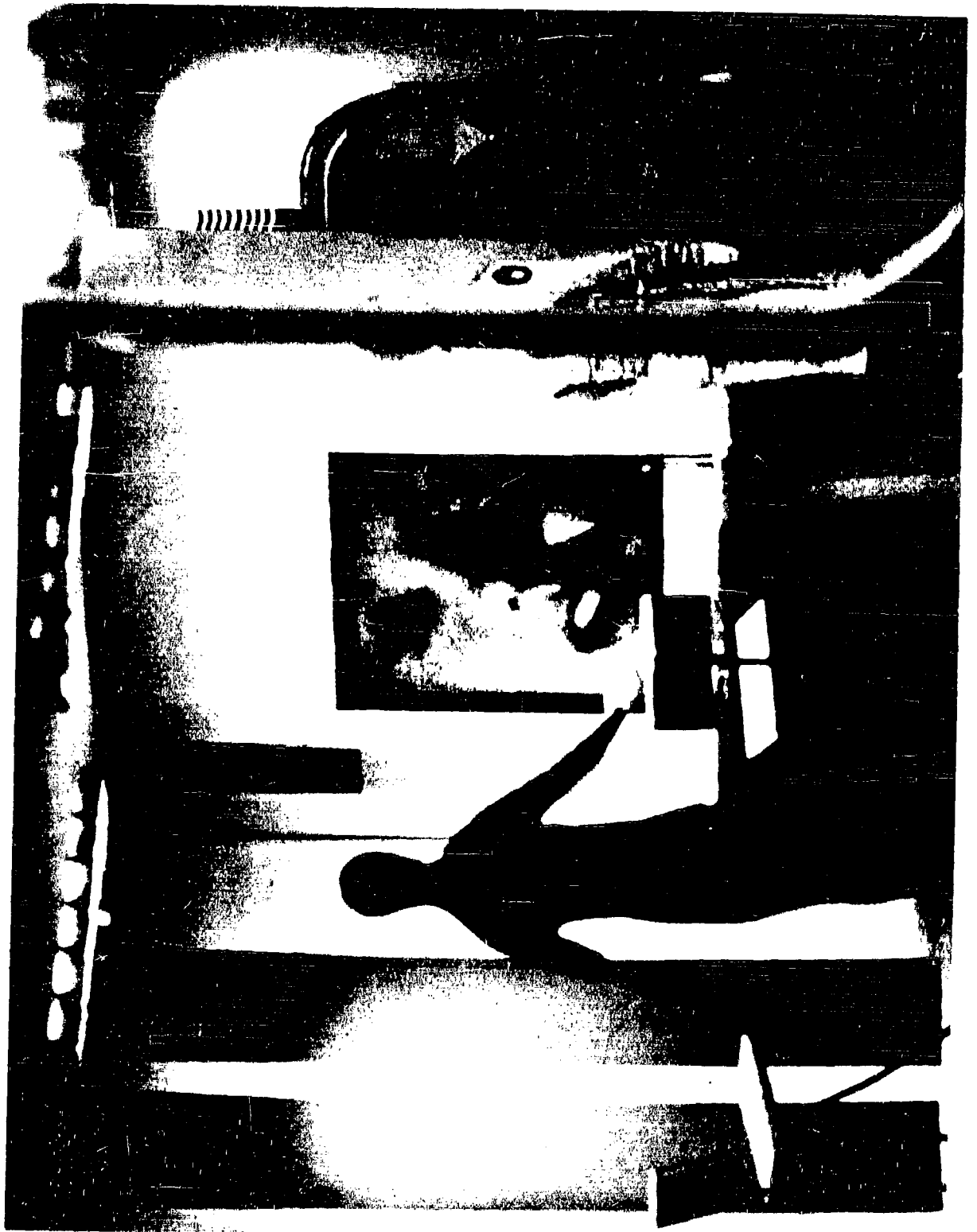

LUNAR SHELTER CONCEPT

Team #7

1. David G. Heckman I.D. 63
2. Chang G. Kim Arch 64
3. Martin H. Pitstick I.D. 65
4. Robert Turner Arch 64

I. DESIGN PHILOSOPHY

In order to make clear the concept, a few assumptions will be made:

1. 6" minimum of lunar dust and rubble on the surface of the moon.
2. Atmosphere consists of a hard vacuum.
3. Temperature varies from -250°F to $+225^{\circ}\text{F}$ in a period of 4 hours or more.
4. Water as such will not exist.
5. Lunar dust and rubble will not be a radiological hazard.
6. Assume 10' of dust for maximum protection and 2 feet of dust for normal protection.
7. Men will be capable of working outside for a period of not more than 3 hours.
8. Assume that the space-ship will be launched from a manned space base.
9. Assume that the Lunar Rubble will easily support the weight of two units without undue settling of dust.

Criteria for Design

The shelter must be protected from materials and radiation. In case of puncture, the shelter must provide adequate protection from total decompression. The shelter must provide for the socialological and phycho-logical needs of the men. The shelter must be easily expanded in order to include more units.

Our team decided that it would be most advantageous to use a module as the basic unit of the shelter. In this way, the shelter could most easily be expanded. In using separate units, adequate sound protection could be achieved without the use of mechanical devices.

The erection of the units should be done (for the most part) by automation. The men would assist only in a minor capacity. The idea of psychological well-being will be greatly reinforced through the use of windows; thereby, connecting the interior of the capsule with the exterior. This, of course, could most easily be done if the units were not covered with 10' of dust.

II. PACKAGE AND ERECTION TECHNIQUES

A cargo ship will land on the moon after being launched from the space station. The units themselves will have been packaged into 4 primary packages: The first package will contain the 3 lower units and the access tube. The second package will contain the two upper units. The third package will contain the solar batteries. The last package will contain the solar unit, and black body radiators for heat dissipation.

The packages will be dropped by means of a winch. Each unit will be attached one to the other with a mechanically operated detonating couple. The detonator will be set off by means of rip cord attached to the side of the packages. When the cargo ship lands on the moon, the rover will unlatch a bottom hatch of rocket allowing the packages to be dropped by means of an operating panel in one leg of the ship. The weight of the packages will cause the winch to unwind. (see board #1)

As the bundles hit ground, a crew member will detonate the couples. The rover will pick up the packages and carry them to a pre-planned point. By means of the rover the packages will be pulled apart, and the units will begin to inflate. By the time the rover has pulled the units apart, they will have become fully inflated and dropped into position for sealing. (see slides) The right hand unit will be attached to center unit by means of a hinge in the floor. The left unit will be attached to main unit by means of a hinge at the top of door. The main access tunnel will be hinged to the top of air lock door. When the honeycomb walls are injected with carbon dioxide, a rigidizing action will go into effect. The skins will bond to the expandable honeycomb by means of an encapsulated epoxy resin plasticiser.

The sealing action will be as follows: The rover will exert an upward pressure at the base of the right unit; thereby, causing a vacuum welded seal at door and in the floor. At this time all necessary mechanical connections for air, water, power, and communications will be made (see detail #4, board #8). Moon rover will now proceed to door hinge between center and left units. By exerting upward pull at hook above hinge a vacuum, welded seal at door frame and in the floor will take place. The main tunnel will be attached in same manner, and dropped into position to seal. Lower units are now ready to be occupied. The moon rover will now start the covering operation.

Men inside center unit will now actuate the expansion and rigidizing process in the vertical access tube. By this time the second bundle will have been separated from winch and be ready to be positioned on pile of dust above lower units. The rover will pull upward unit package apart centering it over access tube. Connecting air lock of the upper units will be integrally attached to the recreation unit and hinged at the top of the door at the laboratory unit. After upper units have been properly positioned over the access tube, the sealing operation will commence as

follows:

Exerting upward pull above door at laboratory unit will cause hinges in floor and door to seal.

Note: By this time the upper units will have been fully inflated and ready for the main sealing operation.

By means of contact pressure, an encapsulated epoxy resin plasticizer will proceed to bond the outer skins of units together (see board #8, detail #6). A foamed-in-place tube will form a seal between the upper units and the access tube and upper emergency air lock. Access tube and air lock will now be ready for service. Connection of mechanical equipment will be done by crew members at the top of the access tube. (see board #8 detail #8).

Note: See board #8, detail #5) for vacuum-welded seal at door.

As soon as connections have been made, the upper units will be ready for occupation. The rover will have by this time completed a two foot layer of dust, above the floor line of the upper units. (see board #7 also board #8 detail #2), (see detail #1 for walls of lower units). The rover will fill the 2 foot space between walls of upper units with dust. By this time the last bundle will have been lowered and disconnected from winch. The rover will unpackage and set up foamed-in-place 40 ft. diameter solar collector and attached generator, and set up the black body radiators. Radio

antenna will be part of solar collector. The samples buckets will be left in rocket. This completes the moon shelter erection.

Time required will be approximately 5 hours. The samples buckets will be foamed up around a pile of samples and hoisted into the base of rocket. Power for winch will come from the solar generator. A rocket in this case will serve as a cargo ship in that it will transport the shelter to the moon, and carry back samples to the space base for further study.

III. STRUCTURE AND MATERIALS

As has been mentioned before, our design concept employs modular units. The material for walls will be expandable honeycomb attached to skins by means of an epoxy resin plasticizer. The floors of the units will be prefabricated on earth and serve as protection at the tops and bottoms of the bundles during the flight. Floors will be made of a 5 inch styrofoam sandwiched between 2-12 gauge sheets of aluminum. "T" bars 3 feet on center will further strengthen the floors. At the time of fabrication, all interior walls, fittings, and all mechanical units will be fastened to the floors.

Shelves other than base cabinets will

be attached to the walls. Wall skins at these points will be reinforced. Interior walls will be secured to floor and to ceiling. When being fabricated the exterior skins will be pulled down over the equipment and fastened to floor by means of a clamping bar. (see board # 8, detail #1 and 2)

The outer skins of upper units will be coated with a white aluminized finish. This coating will reflect most of the solar heat radiation. The two foot fill space will act as further insulating protection against the severe Lunar temperature variations. The units, by means of access tunnels, can be positioned in a number of different ways. (see board #6)

We chose the vertical solution due to the fact that less area of dust had to be gathered in order to give adequate protection. There will be a 2" clearance between the top of the vertical access tube and sealing slot of the upper units to allow for settling (see board #8 detail #8)

The upper units will be equipped with adjustable 18" in diameter double pane polarized windows. In the event of a solar flare, all windows will immediately rotate to black position.

The mouth of the main tunnel will be protected by an eight foot high mound of dust.

IV. FLOOR PLAN ANALYSIS

Attention is called to boards #2 & 4.

The lower units will contain all necessary equipment in order to sustain life in case of an emergency. The units are planned so that privacy from noise and human activity will be shielded from the sleeping area. Also contained in the sleeping units will be the toilet, lavatory and shower.

In case of sickness, one of the sleeping areas will serve as an emergency sick bay. (see board #3)

The center unit will contain the major mechanical equipment facilities: air rejuvenation & power supply, emergency communication systems, and waste rejuvenation and disposal equipment. Decontamination and the main space suit storage area is connected with the entrance of the air lock. This area will be the pivot point for all circulation. The Kitchen Unit will contain oxygen and water storage. This unit will also contain tools for minor repairs, as well as food preparation and facilities for food storage.

The two upper units will be used for the laboratory group and recreation area. The windows in the laboratory area could be used for observation of the lunar surface, and observation of the earth and other planets.

Notice that all equipment is placed around the units allowing maximum circulation space in the center.

Just across the airlock is the recreation area. We have allowed more space here because we thought that this would be the area where the men could relax. It could also be a place where one can do a mild form of exercise in order to keep physically fit for the atmosphere of earth. As many as 6 persons might use this area at a time. The recreation unit can be used to show movies, read books, and play mildly active games.

Windows are also provided here, not so much for observation, but as a visible connection with the moon. This is necessary in order to keep up morale and prevent a fear of a cave-like existence.

V. ENVIRONMENTAL PROTECTION

In order to keep the pressure up in the units, a procedure had to be planned into the shelter. The result was a series of pressure tight doors connecting the units. These doors must be closed at all times. Therefore, all doors except the vertical access hatch will have automatic closing devices.

In case one of the upper units is punctured by a small meteorite, it will normally be stopped by the dust blanket. If the meteorite passes through the blanket, then the dust will tend to keep the air pressure from dropping rapidly, allowing personnel a fighting chance of evacuating the unit.

If, however, a large meteorite happens to puncture the unit, then at least the other units will remain intact.

Puncturing the access tube will isolate the men in the upper units, but the men below could enter the access tube at the top emergency air lock and repair the tube.

The most disastrous case would be if both of the access tube and center unit were knocked out. All of the units would be sealed off from each other. In this case an alarm will sound in the sleeping unit. These men will put on the three or four spare space suits, depressurize the unit, and make the necessary repairs. For this purpose there will be four spare space suits in the sleeping unit.

VI. INTERIOR FURNISHINGS AND EQUIPMENT

At the time of fabrication on earth, all equipment will be bolted to the floors. The furnishings will also be integrally built as part of the units. Only the round table in the kitchen unit plus the collapsible stools in the mechanical equipment unit and laboratory unit will be left loose.

All of the units will have individual air supply and return ducts to the air rejuvenation center. This will greatly decrease the possibility of total decompression in all units at the same time. Heat will be dissipated through the black body radiators located just beyond the complex.

Power and water will also be supplied to every unit through ducts, and conduits in the floor (see board #8 detail #4)

Air pressure panels and alarms will be located in every unit. In case of an emergency, one will only have to observe the panel in order to locate the stricken area. All shelves and interior walls will be hung from the interior walls of the shells. (see board #3) Communications panels will also be located in every unit.

The color scheme will be beige with spot color accents.

Variable moods can be created through the use of lighting. Incandescent lighting will be used throughout. Colors will be gold, white, pink, and blue. Intensities will vary from zero foot candles to a maximum of forty foot candles. Lights will either be located in the top of equipment, or in metal troughs around the perimeter of the units. All lighting will be indirect. (For multi purpose table in recreation unit see board #2)

VII. STATISTICAL INFORMATION

Area	
One Unit	154 Ft. ²
Five Units	770 Ft. ²
Cubage	5,900 Ft. ³
Total Weight	3680#.
Food Preparation	14 Ft. ²
Recreation Area	154 Ft. ²
Toilet	14 "
Shower	30 "
Tools	6 "
Communication	8 "
Labs.	40 "
Space Suit	16 "
Decontamination	40 "
Air-lock	30 "
Batteries	8 "

VIII. THEORETICAL ADVANTAGES OF THIS CONCEPT.

The advantages of this concept are many. We shall compare this method with that of using the 14 x 35 capsule.

In the first place, the ship which carries the shelter to the moon can also be used for a return trip. Naturally some samples of the lunar materials samples, as well as the result of many experiments, will want to be returned to the earth for further study. Using this concept, the cargo will return to the space station and be transferred to an earthbound ship.

Only $1 \frac{3}{4}$ acres of dust will be needed to cover the base. This is less than $\frac{2}{3}$ of the dust required for a capsule structure. The entire structure will weigh only 4000 pounds, allowing 1000 lbs. for more much needed equipment.

Erection time should be about the same as for the capsule. Total usable area is 770 square feet, much more than can be achieved from the capsule method.

Finally, the psychological advantage of this concept could mean the difference between a level-headed crew, and a group of irritable individuals.

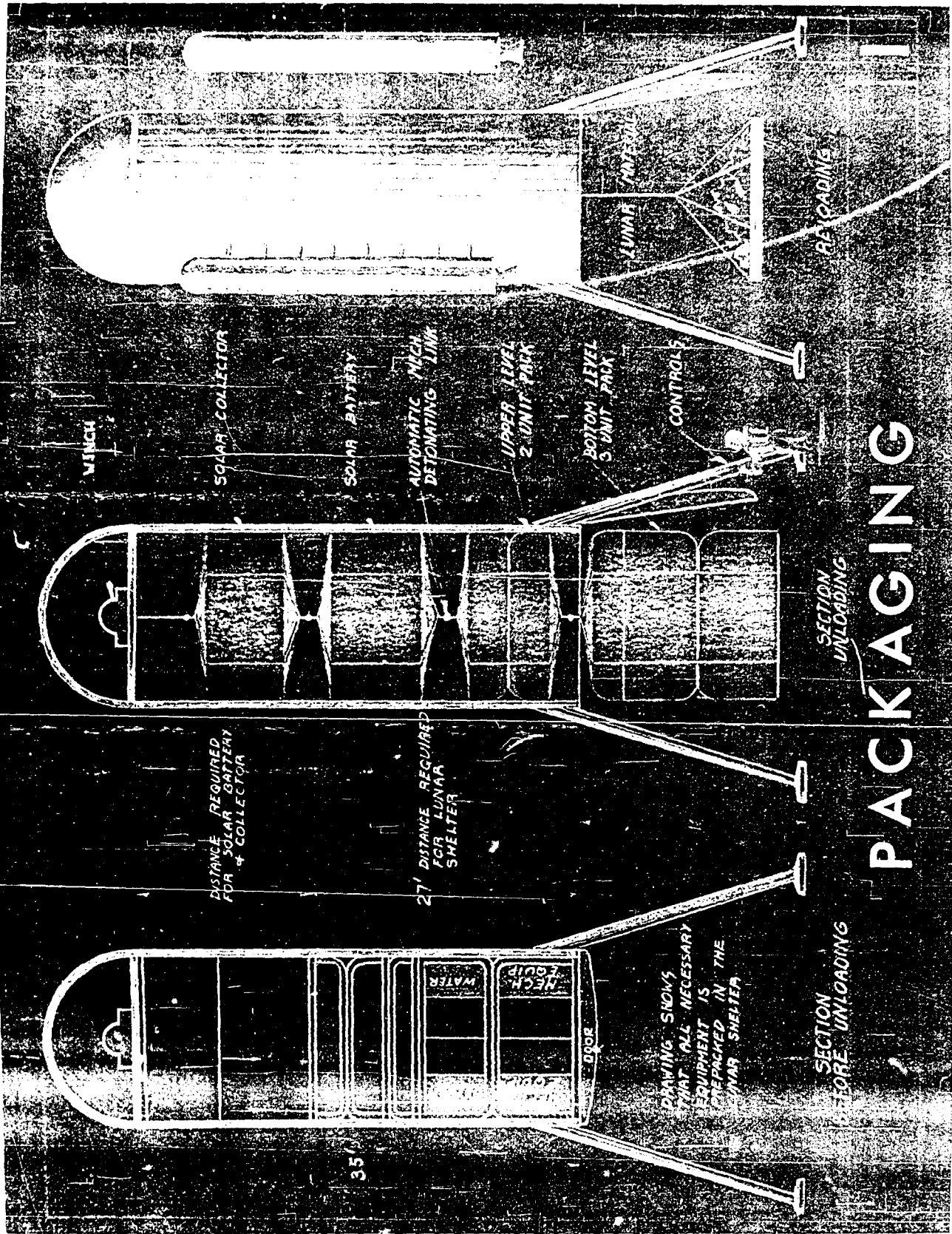

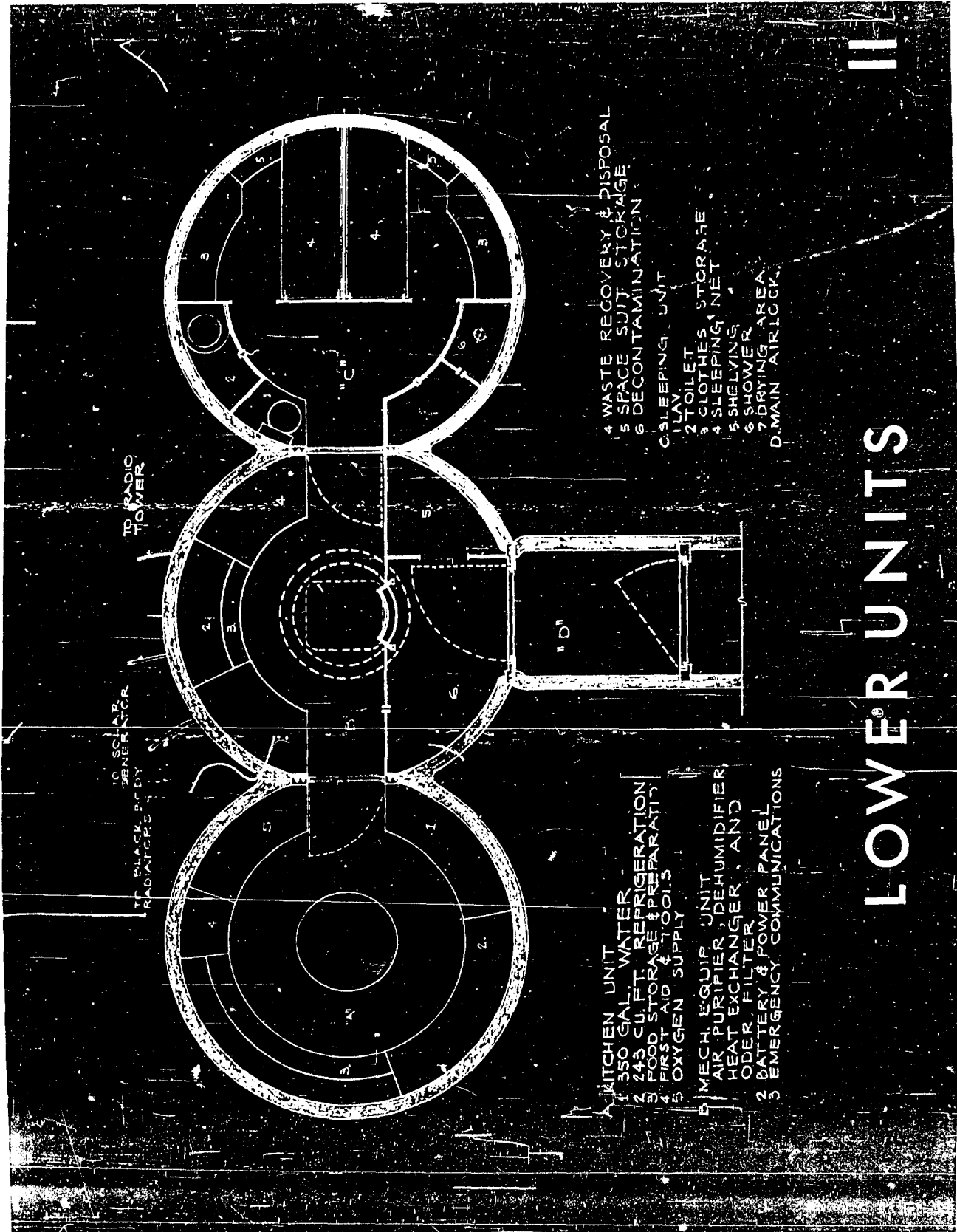

LOWER UNITS

III

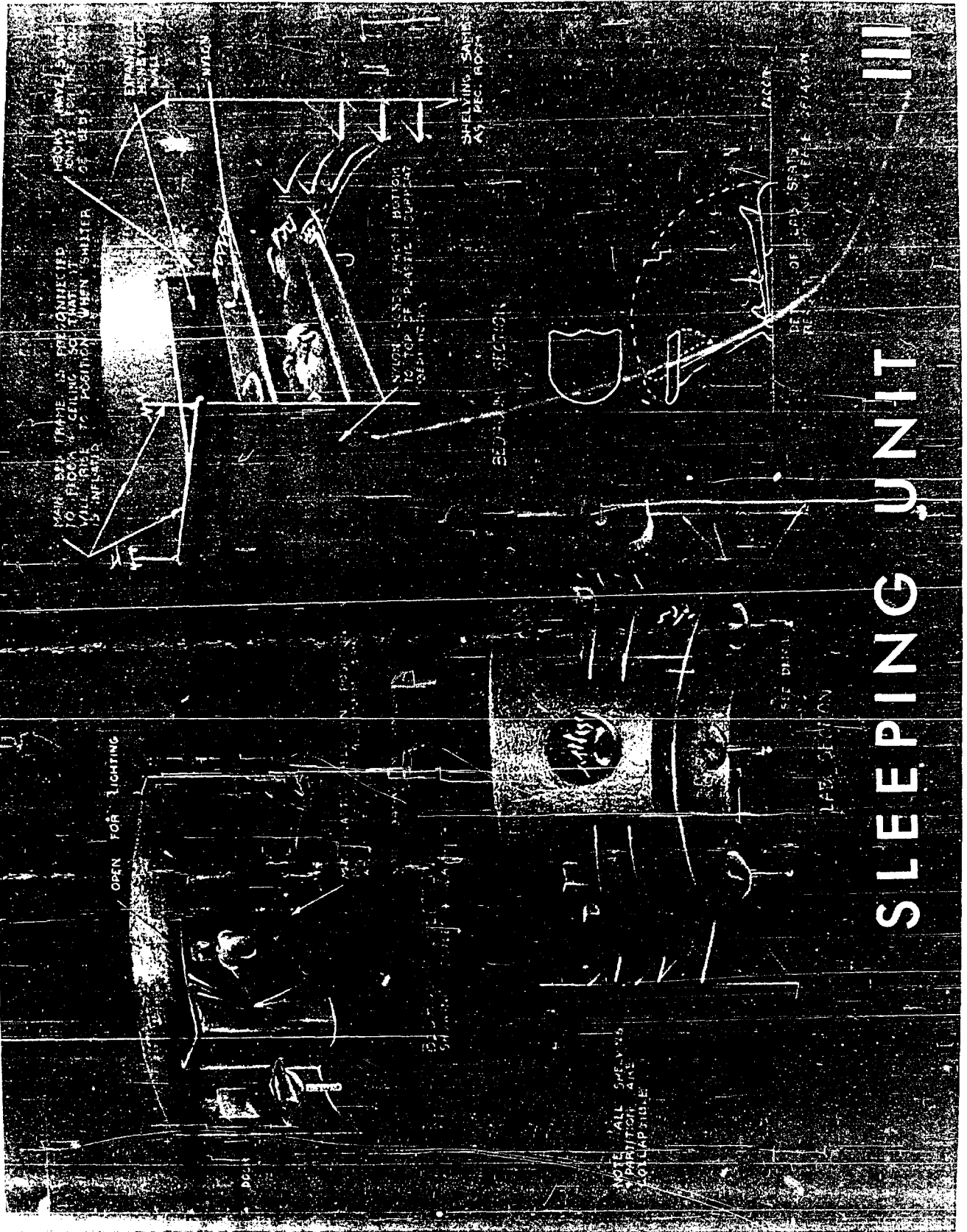

SLEEPING UNIT



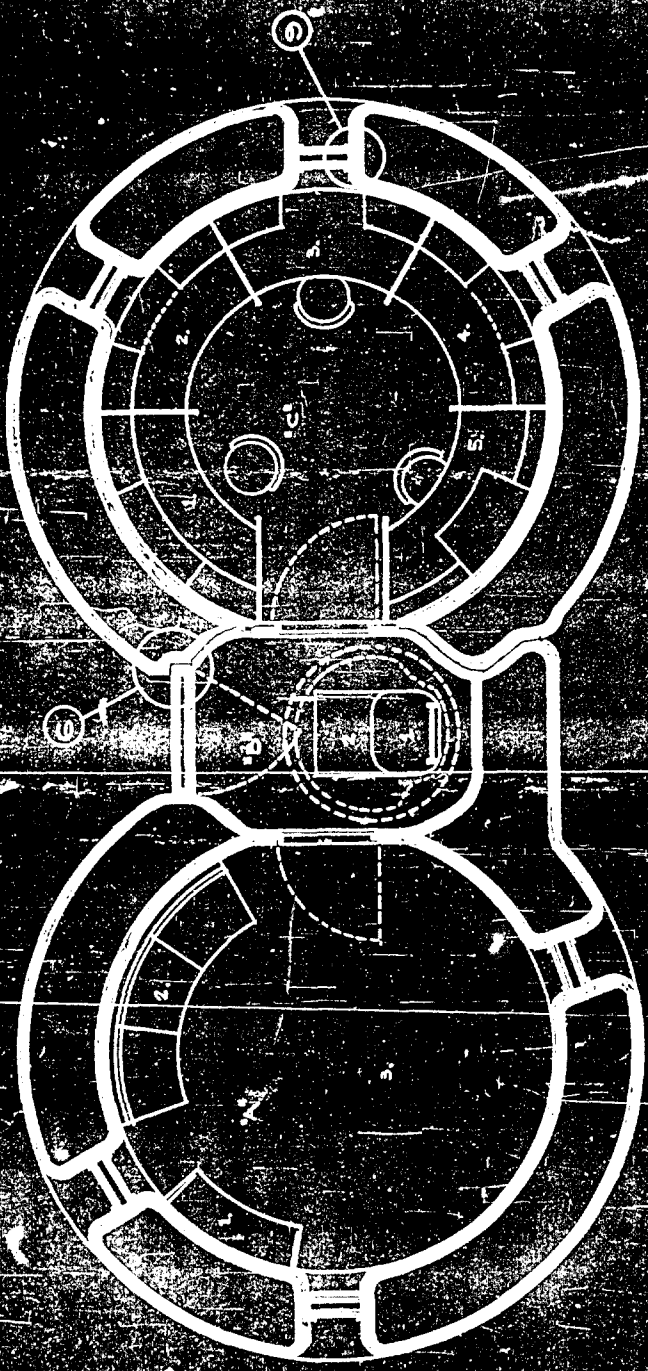

A RECREATION UNIT
 1 COLLAPSIBLE BHELYING
 CHAIRMAN'S SEAT TABLE
 3 ALL PURPOSE

6 LABORATORY UNIT
 1 MULTI-PURPOSE LAB
 2 BIOLOGICAL LAB
 3 ANALYSIS LAB
 4 GENERAL PURPOSE LABORATORY
 5 COMMUNICATIONS AREA
 7 EMERGENCY COMMUNICATIONS
 8 EQUIPMENT UNIT

UPPER UNITS

IV

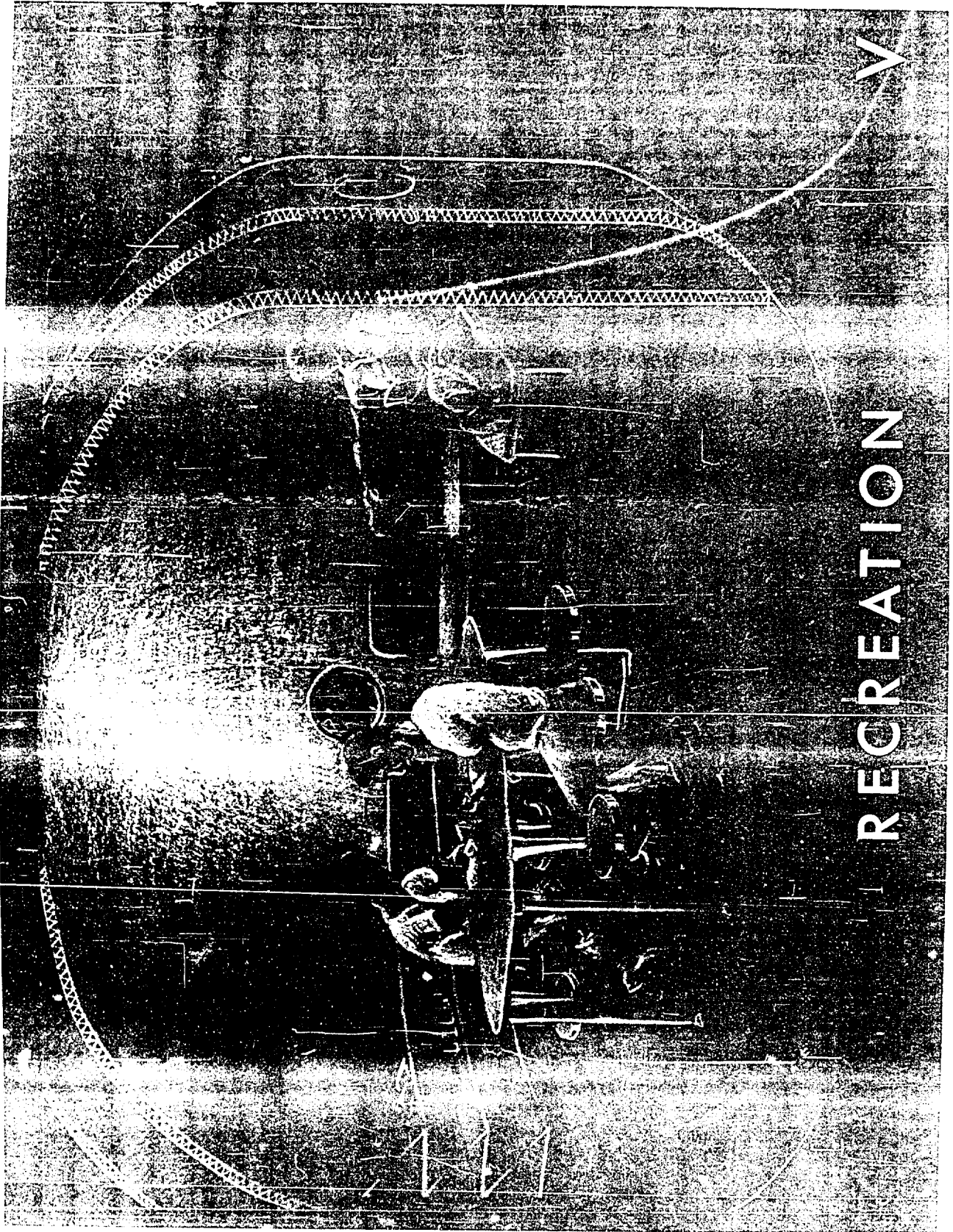

SOLUTION

ALT. METHOD

VI



VII

SECTION

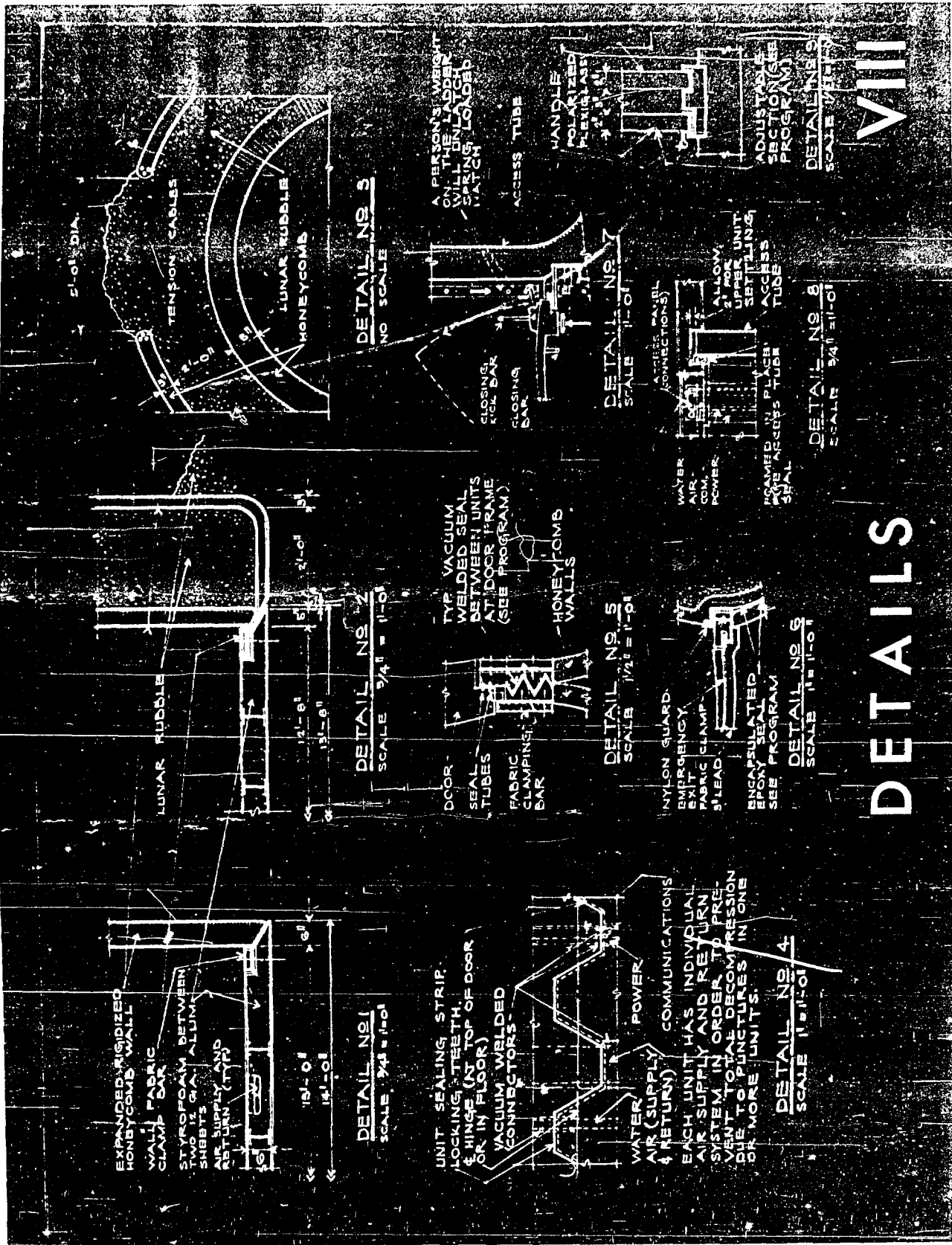

DETAILS

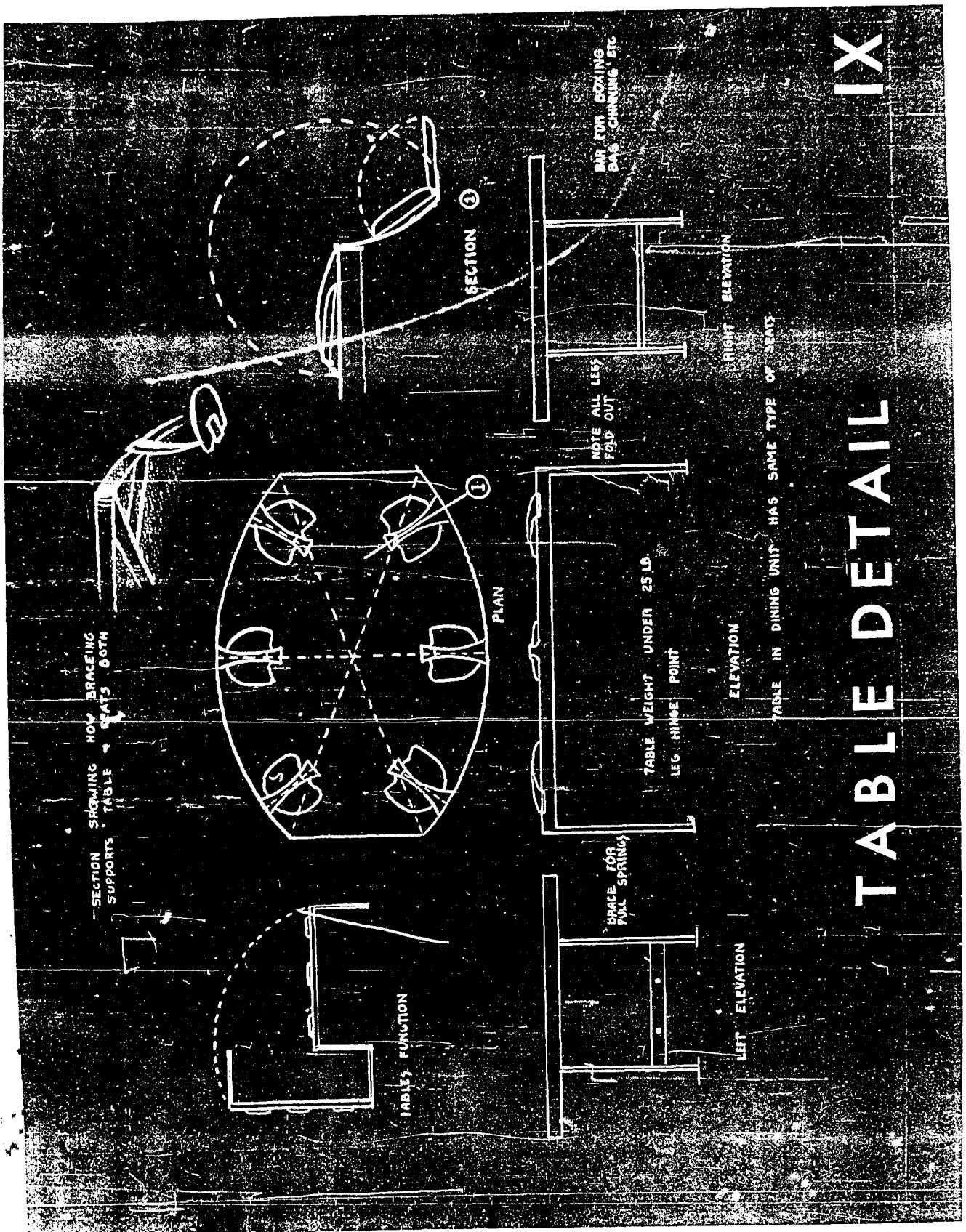

IX

TABLE DETAIL

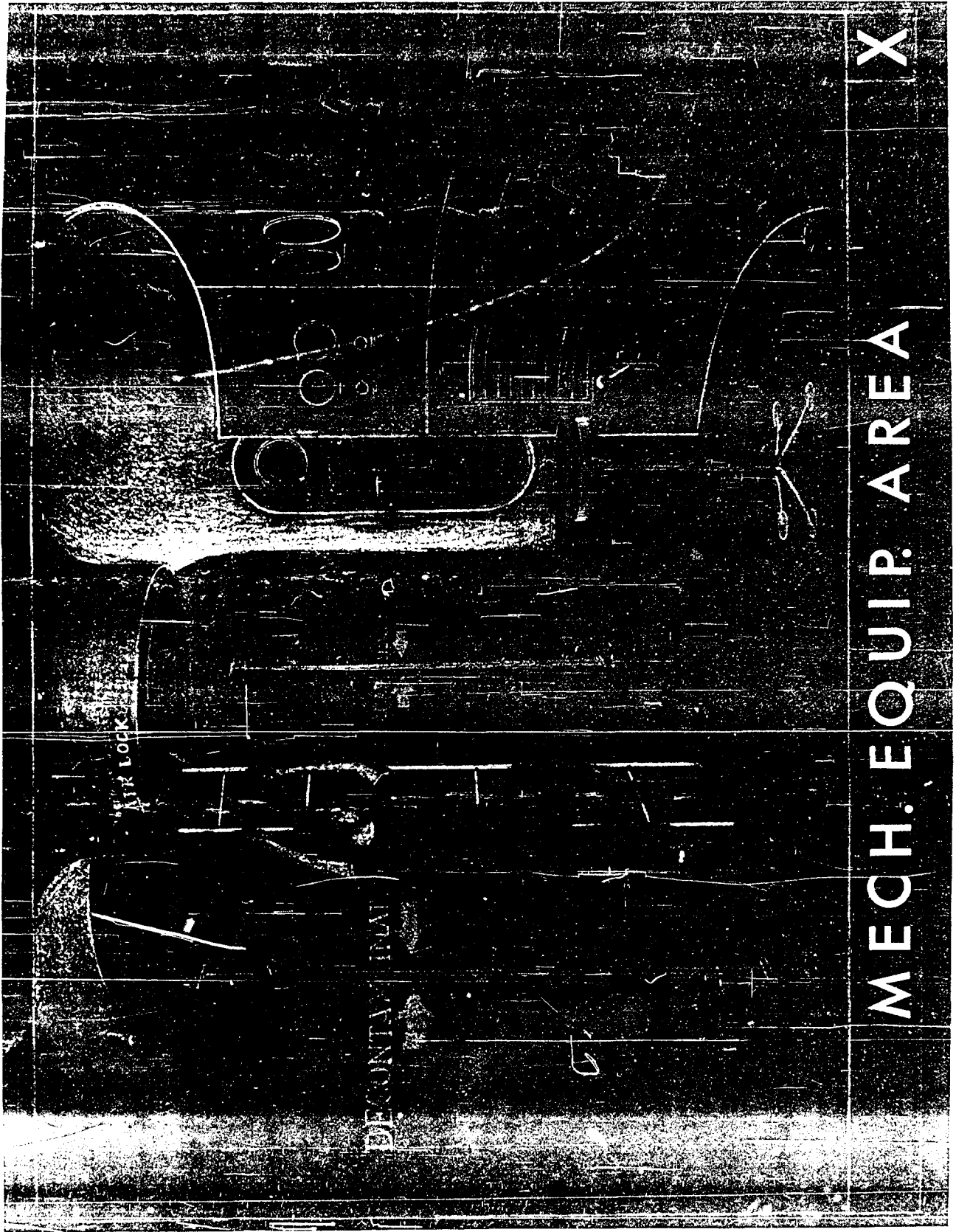









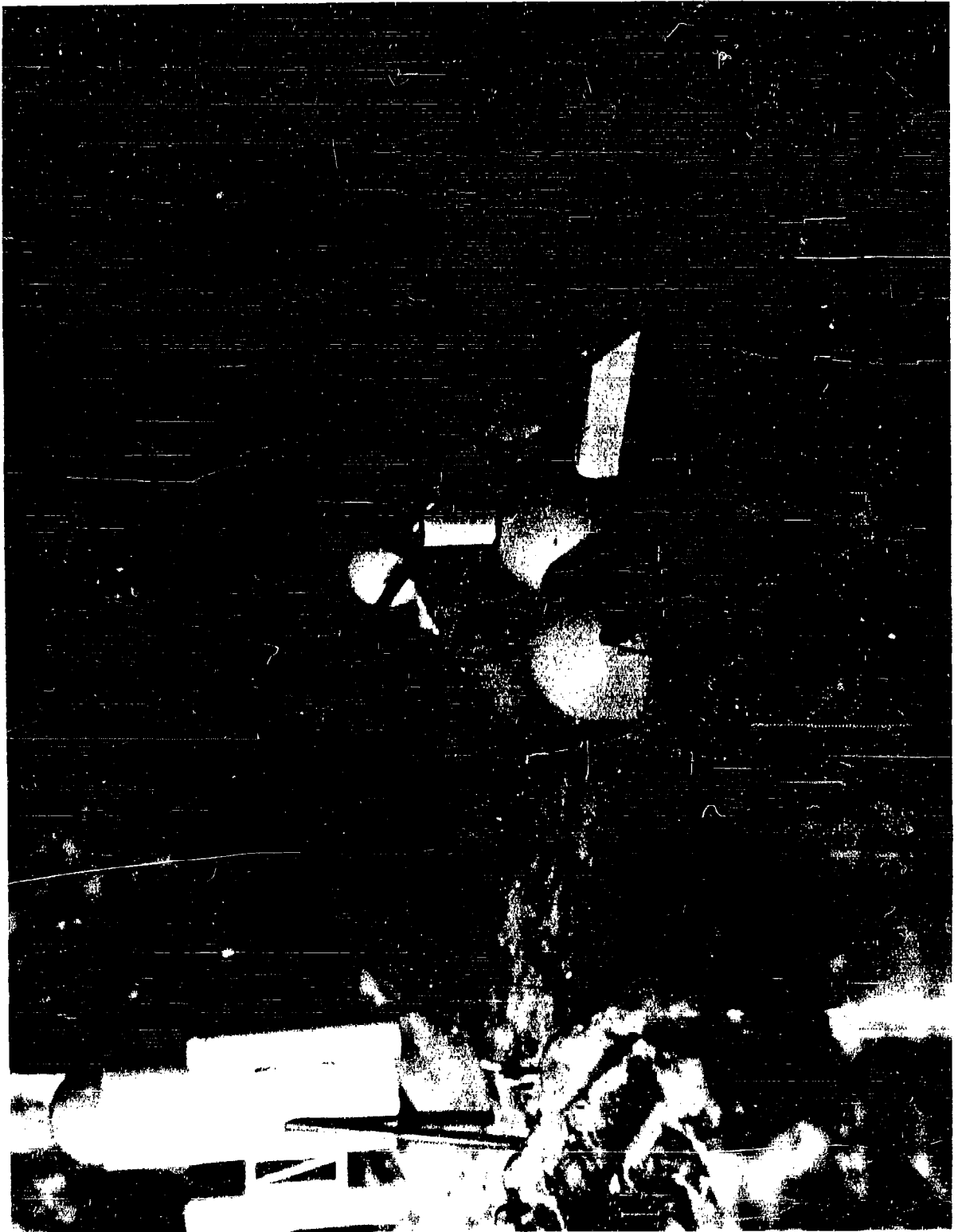





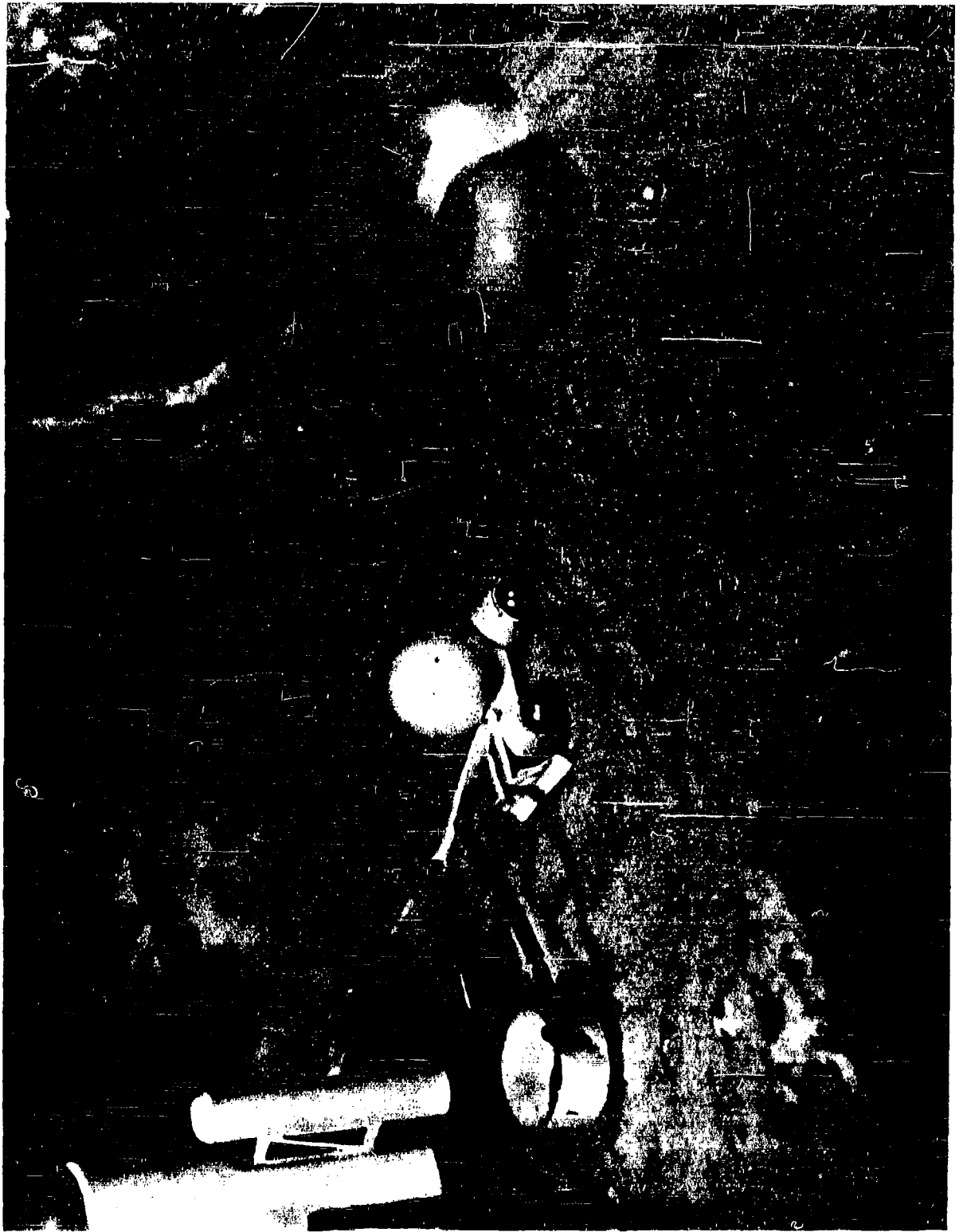





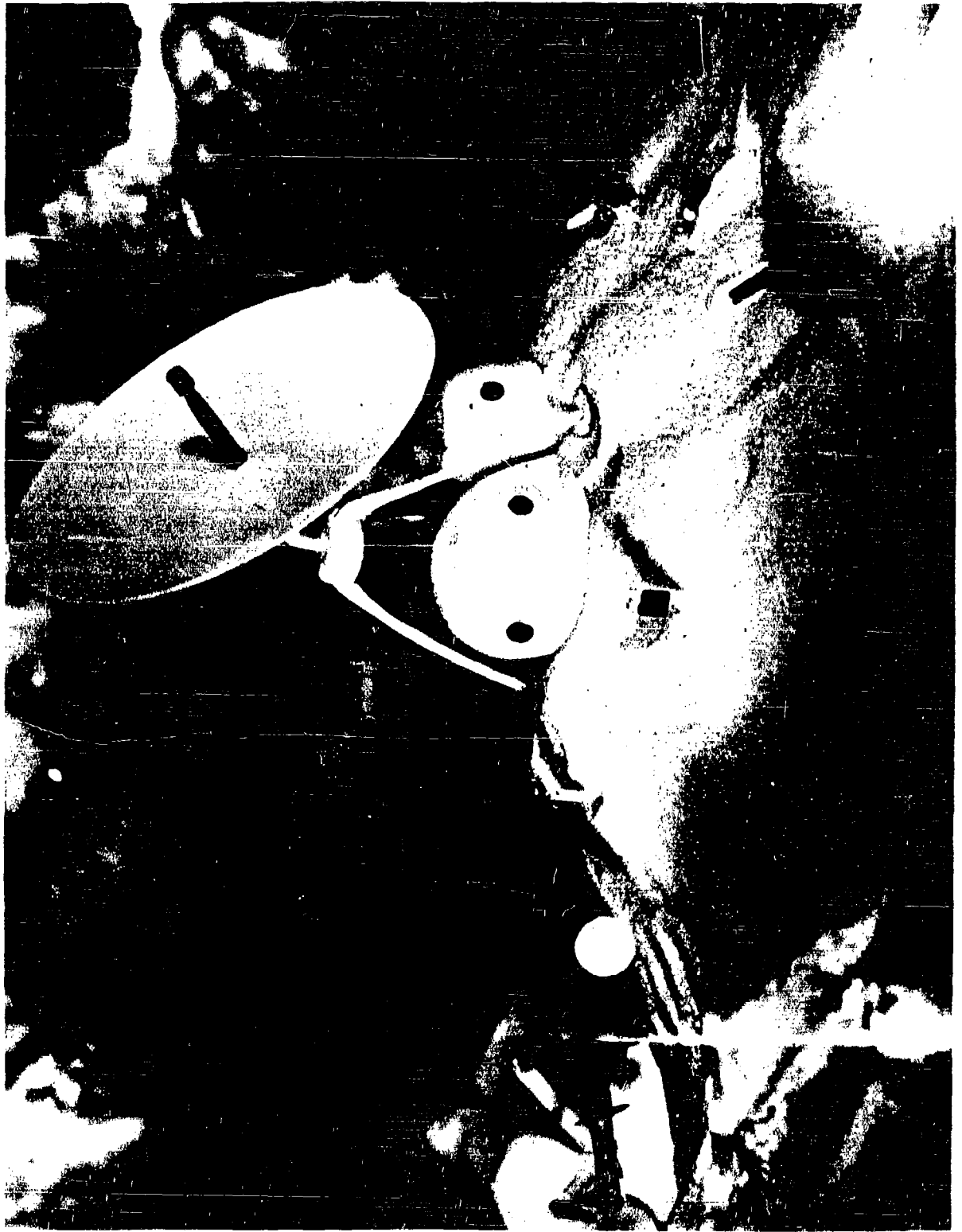



LUNAR SHELTER CONCEPTS

Ronald Batterson,	Arch.	'64
Larry Blackman,	Arch.	'64
John Bulcroft,	Ind. Des.	'64
William Duchek,	Arch.	'64

DESIGN PHILOSOPHY

The main points of our design philosophy are listed below in outline form:

- * The shelter should be erected in the shortest possible time with minimal labor by the crew.
- * There should be as few moving parts in the actual erection of the shelter as possible.
- * All materials and equipment transported to the moon should be utilized to their fullest capacity.
- * Due to the harsh environment of the moon and other unknown factors, the shelter should provide as large a safety factor as possible.
- * The design solution reached by our team is to be compatible with existing technology and be able to be implemented in the immediate future.
- * The shelter should contain a built in system for survival if part of it is damaged.
- *F For better circulation and environmental comfort, the shelter's components should be on one level.

PACKAGE & ERECTION TECHNIQUES

The shelter is composed primarily of the capsule in which it is transported to the moon. All equipment and materials to be used are in place, thus there is a

minimal amount of labor required from the crew.

Erection technique is as follows:

- * The capsule is lowered to a horizontal position by the Moon Traversing Vehicle.
- * A panel on each side of the shelter is removed (these serve as Black Body Radiators), and an airmat room extends on each side. (Expansion powered by high pressure air in capsule.)
- * An airmat entrance tunnel and the solar reflector are added.
- * All airmat structures are stabilized by foam.
- * Entire shelter is then covered with lunar rubble to a depth of ten feet.

STRUCTURES & MATERIALS

No radical materials are proposed. Shelter as conceived can be built primarily with "off the shelf" hardware. Typical Aircraft/Rocket construction is to be used as main body of shelter. Airmat will be used for auxiliary appendages. Lunar rubble will be used as protection against radiation and meteorites.

FLOOR PLAN ANALYSIS

The shelter is divided into three main areas: laboratory, sleeping/personal hygiene and recreation/eating. The floor plan has been designed to allow

access to any area or the exterior of the shelter without passing through another area. Through a system of hatches, each area is a separate entity and, in event of the loss of pressure in one area, the other two would not be affected. Also, each area has access to space suits and emergency exits. Noisy equipment has been separated from sleeping and communication areas.

ENVIRONMENTAL PROTECTION

The shelter is covered with ten feet of rubble. This should be quite sufficient protection against all known environmental problems.

INTERIOR FURNISHINGS & EQUIPMENT INTEGRATION

All equipment will be built into the capsule. The core walls between the labs and sleeping and recreation areas will serve both areas. All mechanical and electrical equipment is built into the periphery areas of the shelter, thus utilizing all space to the utmost. All equipment and furnishings will be designed to stand shocks of blast off and landing of capsule. The entrance chamber adjacent to the airlock will be used as a preparation area for men and equipment leaving the shelter environment.

STATISTICAL INFORMATION

AREAS AND CUBAGE:

<u>AREA</u>	<u>SIZE</u>	<u>SQ.FT.</u>	<u>CU.FT.</u>
Entrance chamber	8'x9'x8'	72	576
Air lock	8'x3'x8'	24	192
Recreation	12'x16'x8'	192	1536
Sleeping	12'x16'x8'	192	1536
Lab	8'x16'x8'	128	1024
Lab	3'x3 $\frac{1}{2}$ 'x8'	10	80
Totals		618	4944

LUNAR RUBBLE ON SHELTER

46,000 cu. ft.

92,000 sq. ft.

2.1 Acres

THEORETICAL ADVANTAGES OF THIS CONCEPT

- * Complete use of capsule. No extraneous material carried to build a shelter.
- * No relocation of equipment; everything mounted in place and ready to use.
- * Erection simple and fast. Labor is minimal as expansion of capsule is handled by interior air pressure.
- * All movement between areas is on a horizontal plane.
- * Shelter is still able to function and escape provided in the event of loss of pressure or other mishap in any of the areas.
- * Shelter can be built utilizing present day technology and materials.

A LUNAR SHELTER

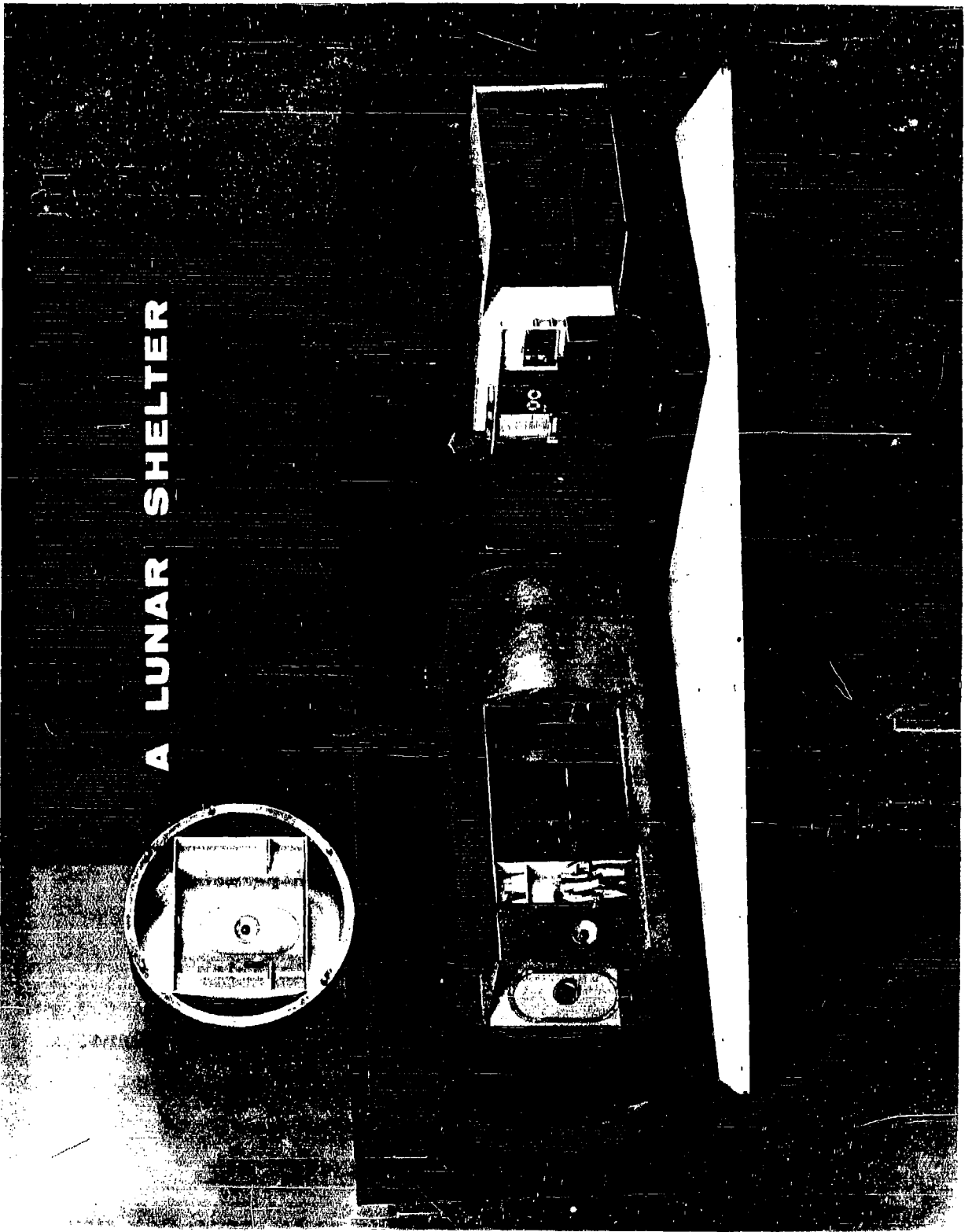



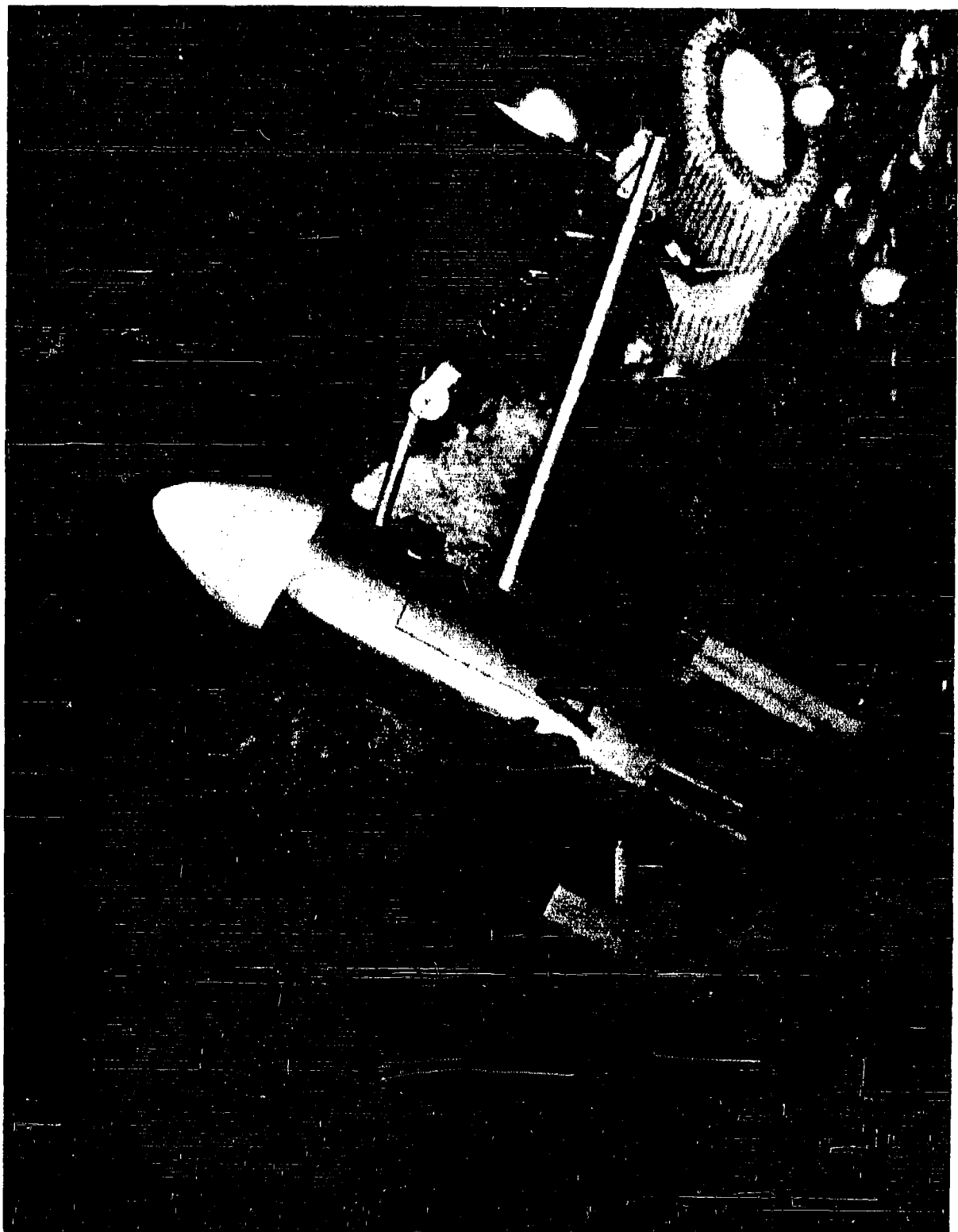

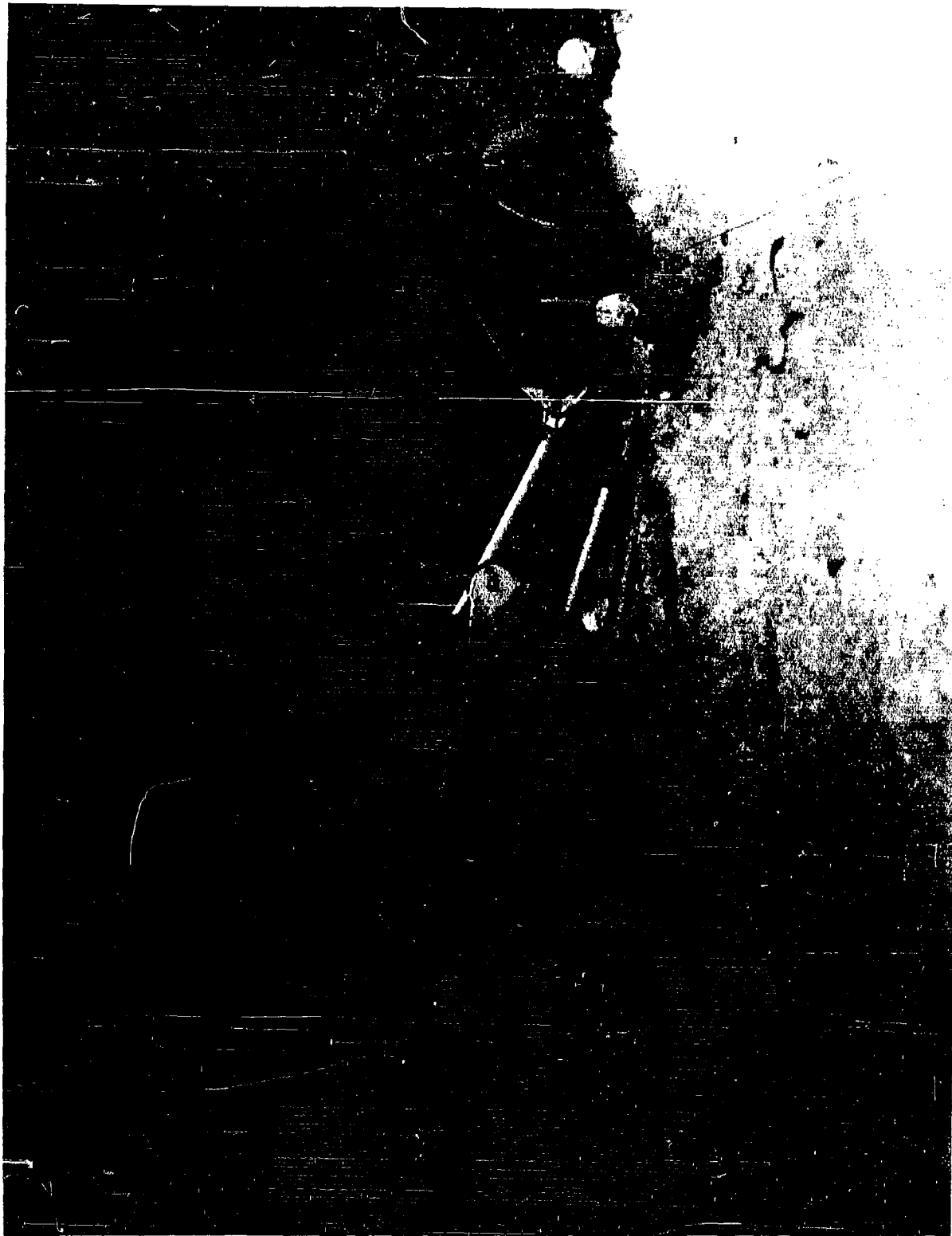



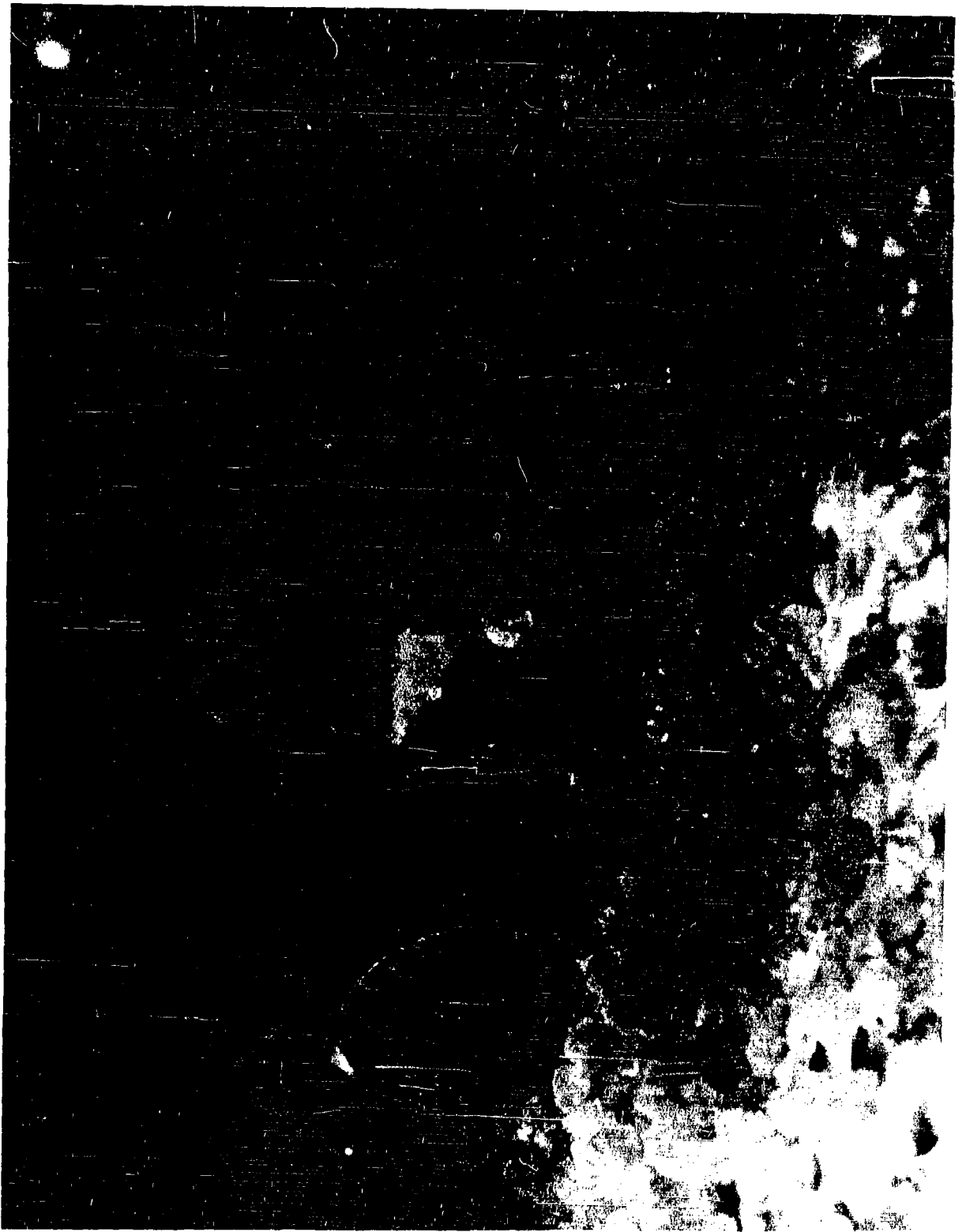

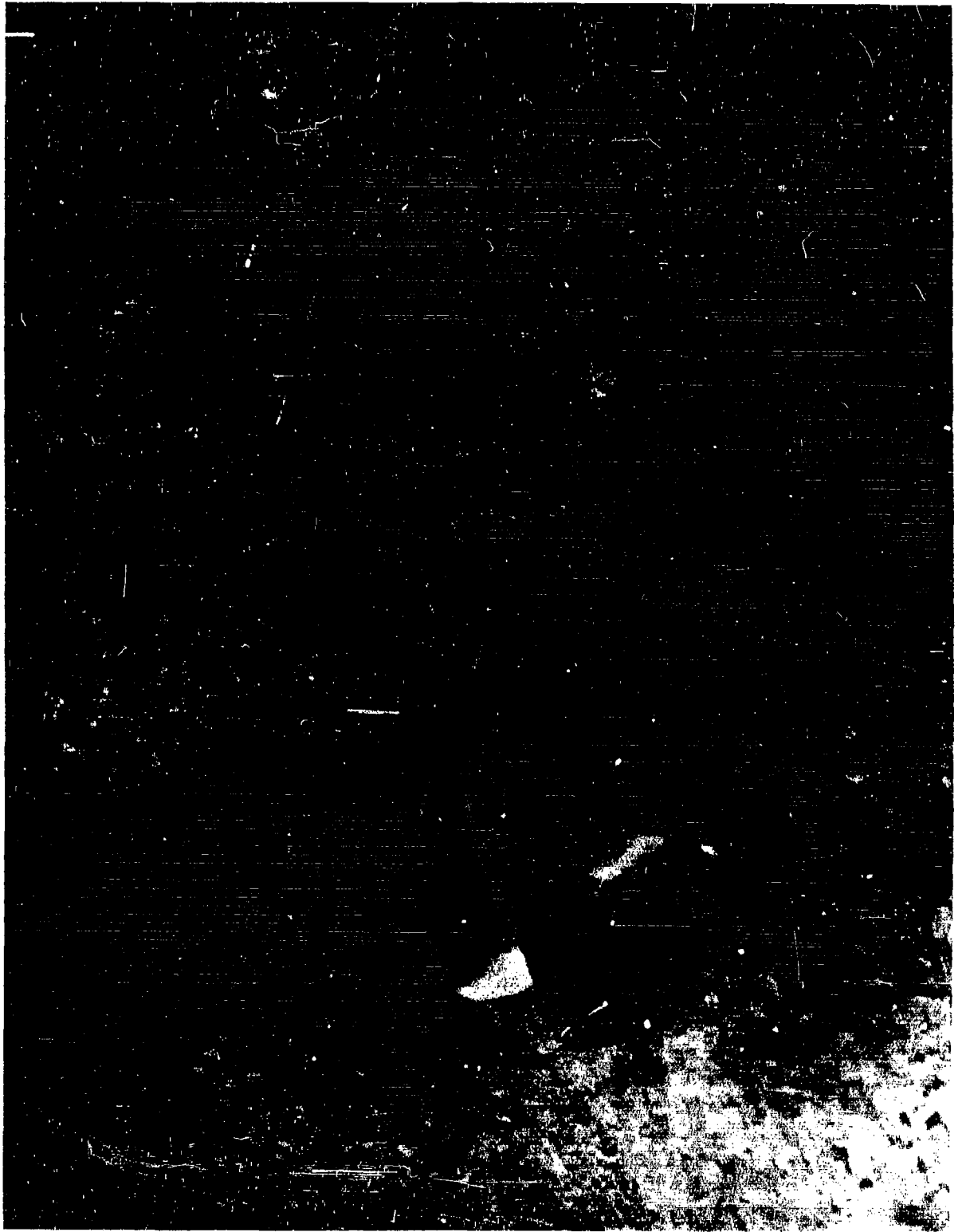



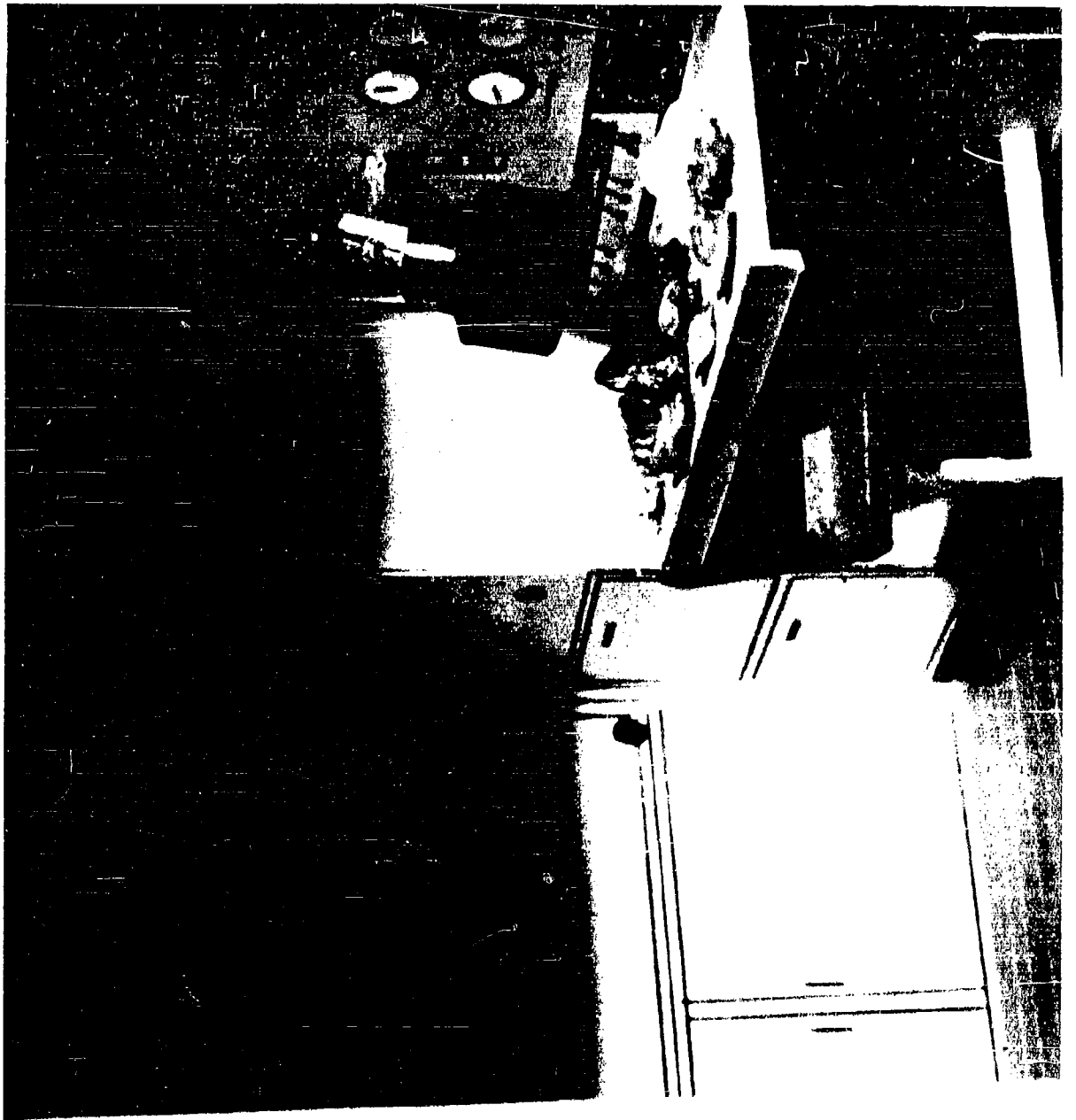

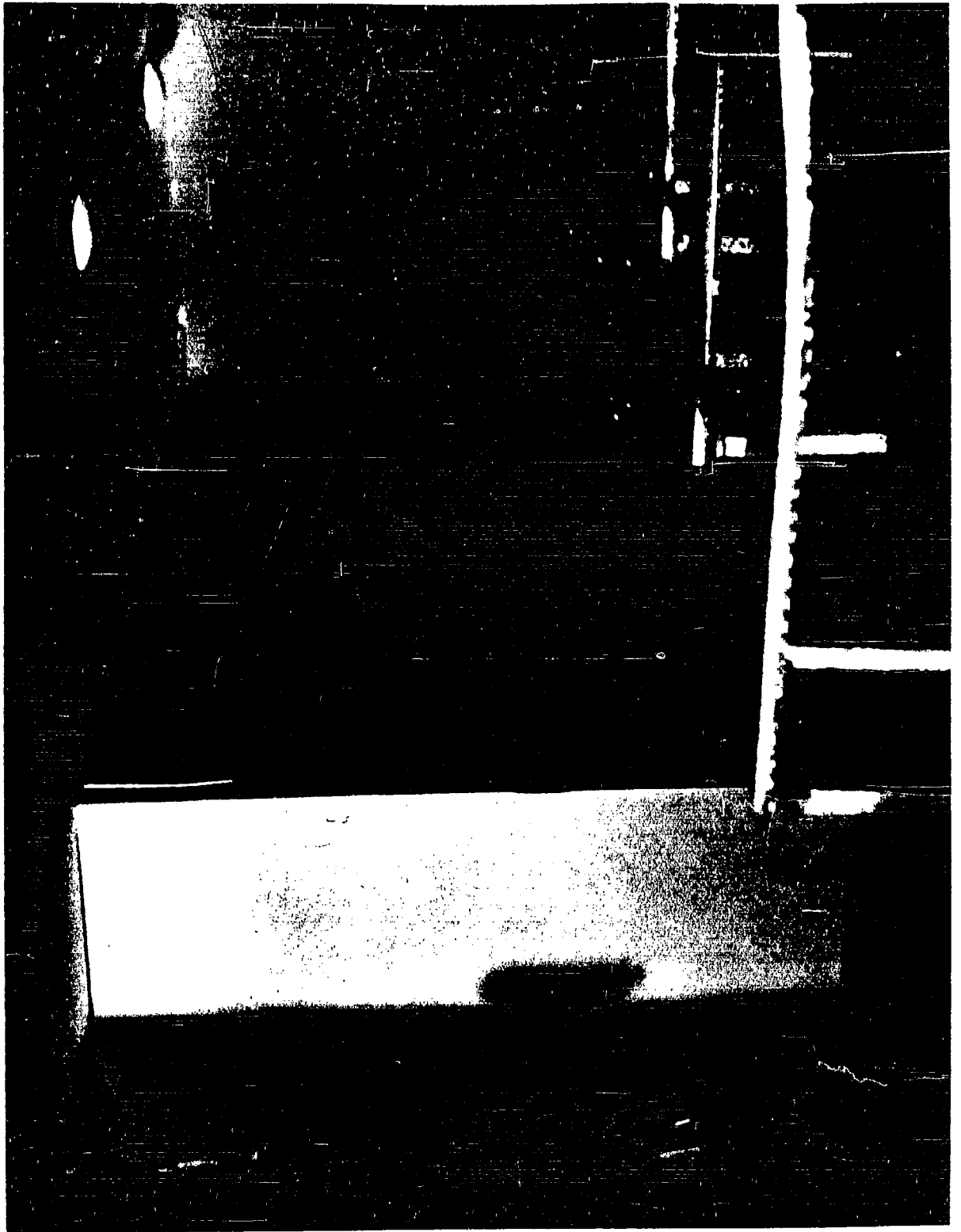

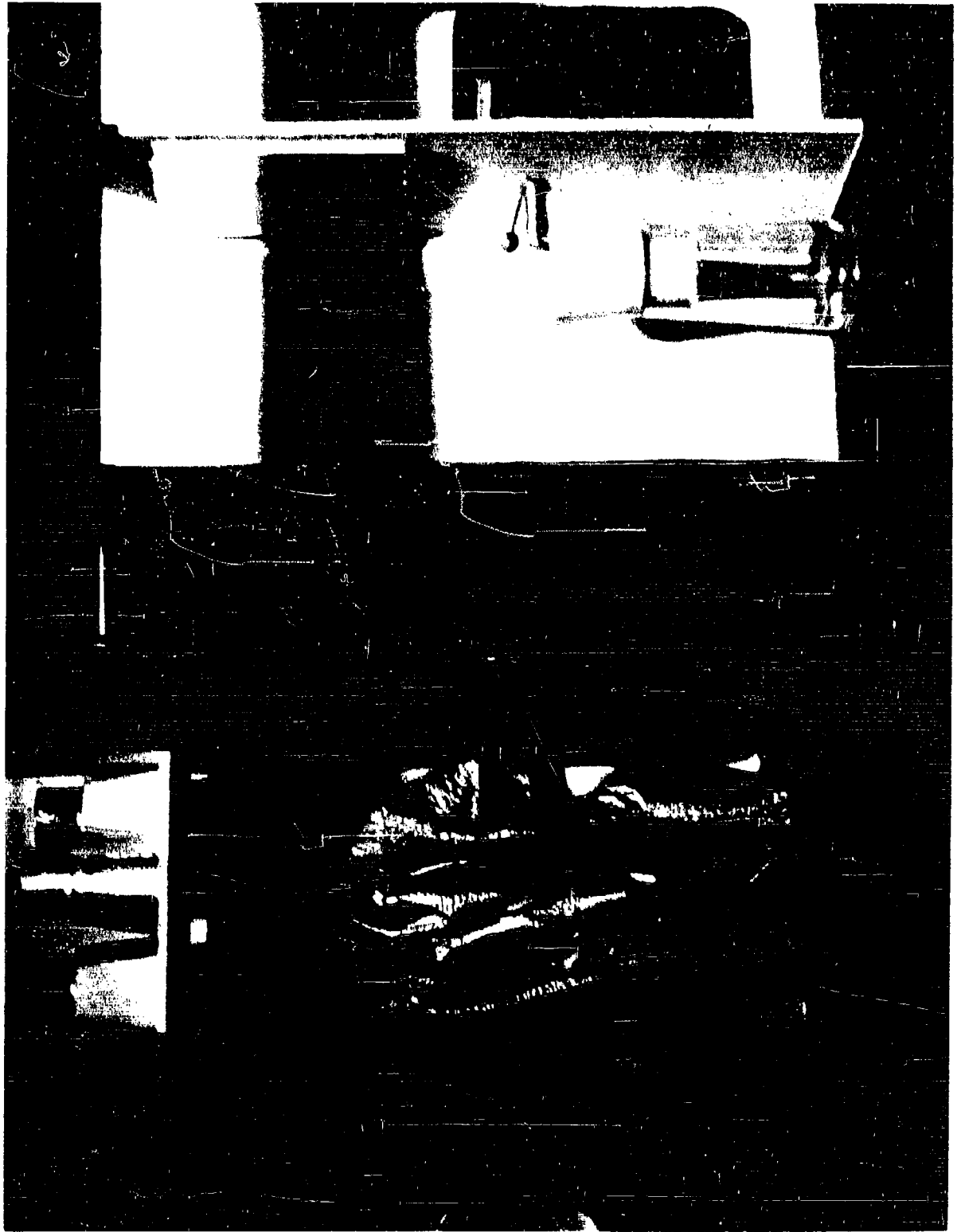

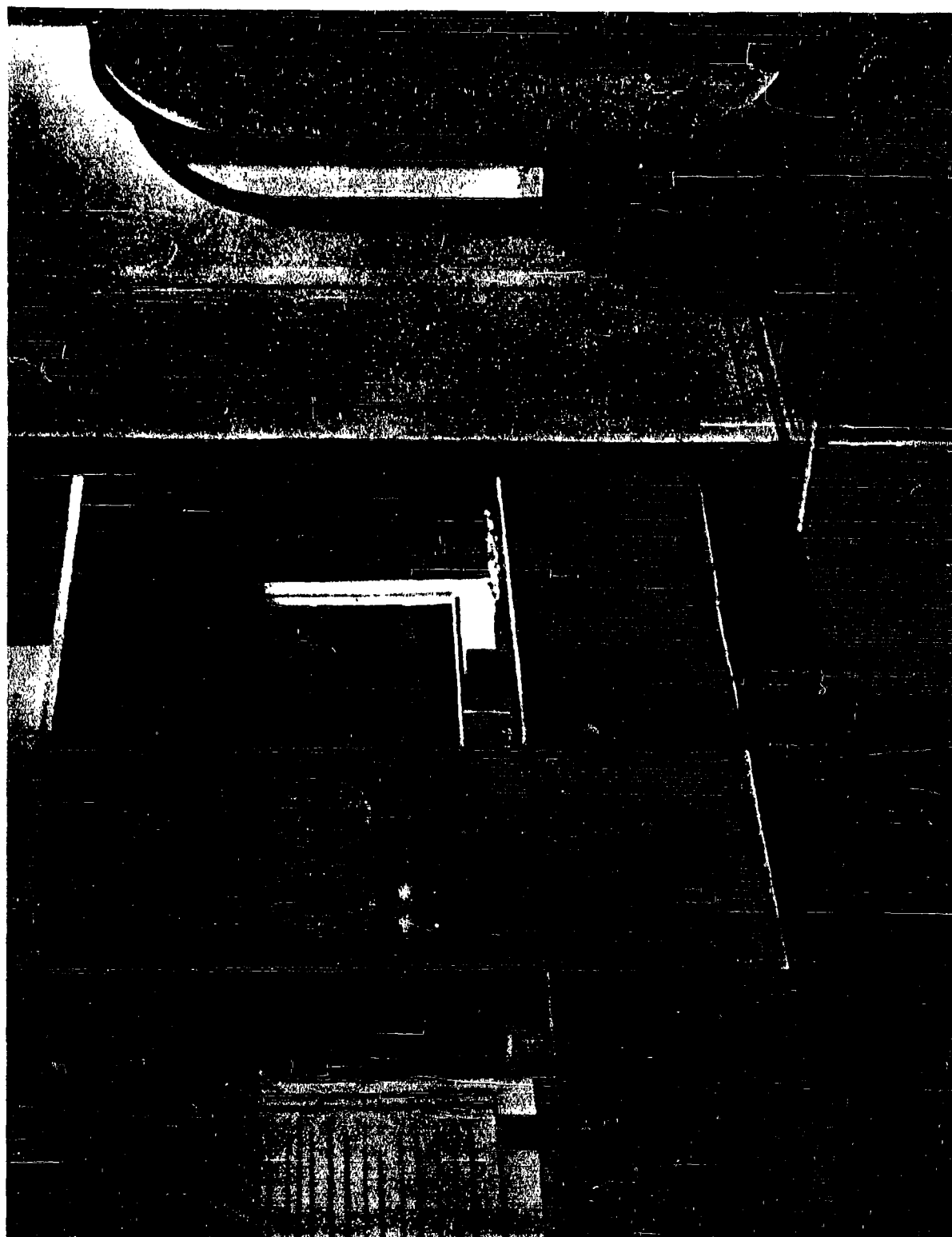

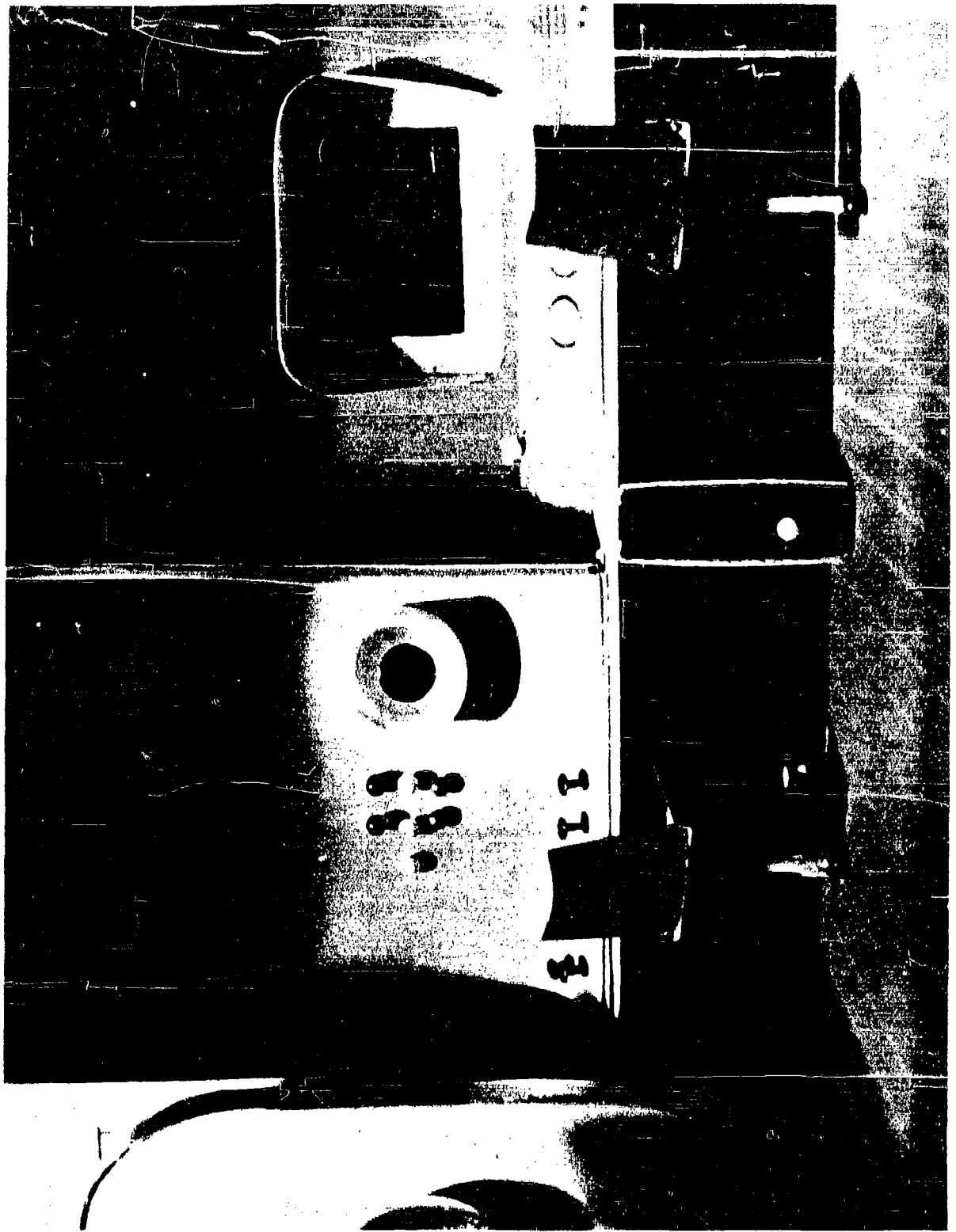

LUNAR SHELTER CONCEPT

Designers: Donald W. Ansman - Arch. '64
James J. Hoetker - I. D. '64
J. Douglas Riehl - Arch. '64
Chester H. Wolgamot - I. D. '63

DESIGN PHILOSOPHY

The basic philosophy and design concept was to create a structure that would serve as a lunar shelter for a complement of nine men for a period of thirty days. This concept was to embody and fulfill the requirements set forth in the Project Program with the emphasis on ease of erection, maximum use of spaces conceived, and minimum requirement of weight.

In meeting these requirements, we proceeded to create an environment that not only met the functional needs of the mission, but also the emotional and psychological needs of the men who are to function under the adverse atmospheric conditions of the moon.

PACKAGE AND ERECTION TECHNIQUE

In the packaged state the expandable airmat is compressed in the recess provided in the shell. Center floor, ceiling and wall panels are stored in the recreation area. Sanitation package is in food preparation area, and furniture and supplies are in remaining areas.

The final stage of the missile will consist of the lunar shelter and a pod of landing or retro-rockets, circling the moon in an orbit determined by the crew upon their landing. The shelter will then be guided in and landed in a vertical position on legs telescoping from the rocket pod.

One crewman will leave the space ship and enter the traversing vehicle which has also previously landed. He will then lower the shelter using magnetic clamps as illustrated on Board Number 1. Once the capsule is on its side, the vehicle will raise one half of the cylinder, fire the explosive bolts holding the two sections together and, utilizing the air pressure inside, allow the two to separate. Hydraulic jacks acting in reverse will drain, allowing the separation process to proceed in a slow controlled manner. The fluid in the jacks (water) will drain into the water system for future use.

The airmat is stretched tight, jacks are locked in place and foam is activated forming a rigid shell. The shelter is then lowered and ready for entry.

Three crew members will remove the solar collector unit from the shelter and mount it on the retro-pod, which was severed from the capsule and returned to a level position.

While the collector is being erected, fellow crewmen, who have removed their spacesuits, are proceeding to install floorpanels, place the shower and lavatory unit, erect the dismantled walls and ceiling sections, unpack furniture and provisions and proceed to the purpose of the mission.

Elapsed time for set down of shelter to shirt-sleeve atmospheric occupancy, 1-2 hours.

STRUCTURE AND MATERIAL

The lunar shelter consists basically of two components: a metal cylinder that separates longitudinally upon landing, and a polyurethane foam airmat that stretches between the two sections to form the airtight outer shell. The metal cylinder consists of an outer and inner skin welded to Airframe sections that carry radially around the cylinder.

The walls, floors and ceilings inside the shelter are sandwich sections made up of aluminum skins with a high density polyurethane foam. Edges are reinforced with channels of needed load-bearing capacity, and the floor sections have a soft vinyl coating.

FLOOR PLAN ANALYSIS

The overall design concept may be visualized as six major functioning areas: Embarcation, Working, Recreation, Sleeping, Mechanical Equipment and Air Circulation. Each area has been located according to its related need for access and sound-conditioning. Exemplary of this is the location of both the mechanical equipment and air circulation areas which are separated from the living quarters by sound-deadening material in the floor and ceiling panels, and the location of the high noise level labs and communications are away from the sleeping facilities.

ENVIRONMENT AND PROTECTION

The climatic environment in the capsule approaches that of the earth's atmosphere in that humidity, temperature and air composition are set for the ideal human requirements.

For psychological purposes, a cool color scheme was chosen for the shelter. Many variances in color and hues may, however, be achieved through the use of luminescent panels controlled by rheostat.

Protection for this environment from solar radiation is accomplished by a covering of 10 feet of lunar dust over the capsule. Entry into the shelter is made through a tunnel attached to the airlock and set at an angle to the structure so that direct horizontal bombardment of this radiation is impossible. Further protection is achieved by incorporating into the design a double hull to decrease the possibility of rupture.

INTERIOR FURNISHING AND EQUIPMENT INTEGRATION

The shell of the structure functions not only as protection, but also as the structural system from which all stationary interior furnishings are mounted. In doing so, interior partitions become essentially non-load bearing and thus are held to a minimum in thickness and weight. All equipment that will be used in experiments and daily functions will be stored on the main level, labs will be self-contained units, and all remaining equipment will be on the lower level.

STATISTICAL INFORMATION

<u>Area</u>	<u>Square Feet</u>	<u>Cubic Feet</u>
Infirmary	58	464
Food dispensary	65	520
Recreation	145	1,160
Sleeping	58	464
Toilet	32	256
Circulation	50	400
Dressing	42	256
Tools and Back Packs	24	192
Communication	45	360
Laboratory	73	584
Space Suit Storage	49	392
Decontamination Area	24	192
Airlock	22	154
Mechanical Equipment Area		418
Storage		476
Equipment Service		1,120
Duct Work		630
Batteries		68
Total	<u>687</u>	<u>8,106</u>

THEORETICAL ADVANTAGES OF CONCEPT

The major advantages of the concept are: use of the launch cylinder as the shelter permitting almost immediate occupancy, separation of noise levels to insure quiet areas and the integration into the design of a double-hulled structure to further decrease the possibility of rupture.



LUNAR SHELTER CONCEPT

Approved by the
 Army Research Office
 and the Air Force
 Office of Scientific
 Research, Durham, N.C.

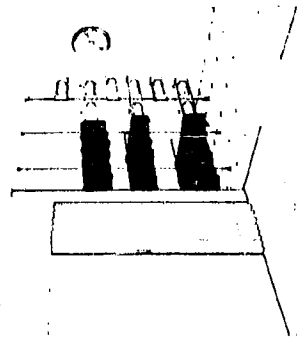

SLEEPING AREA

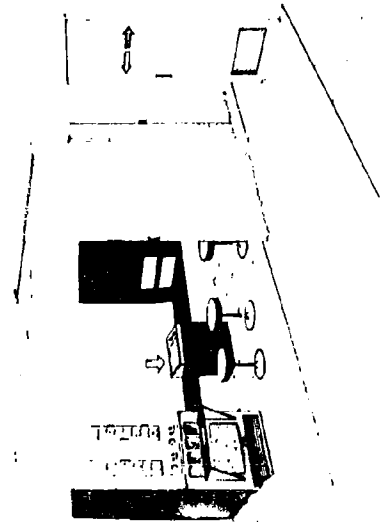

FOOD DISPENSARY

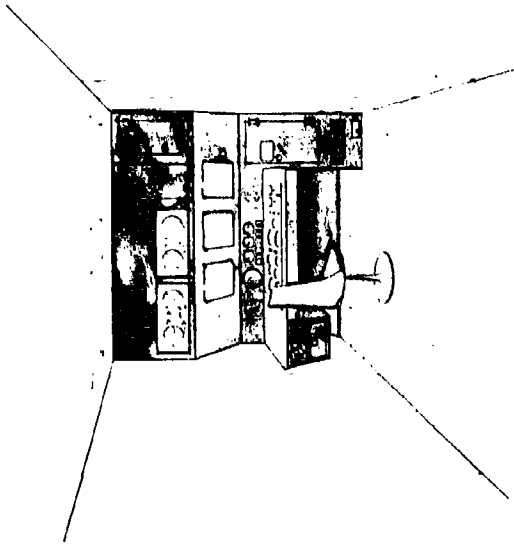

COMMUNICATIONS

ERECTION PROCEDURE

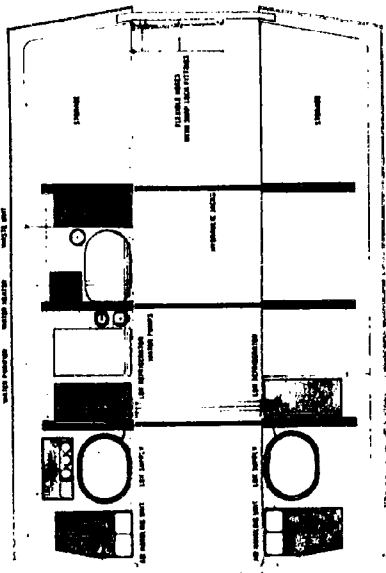
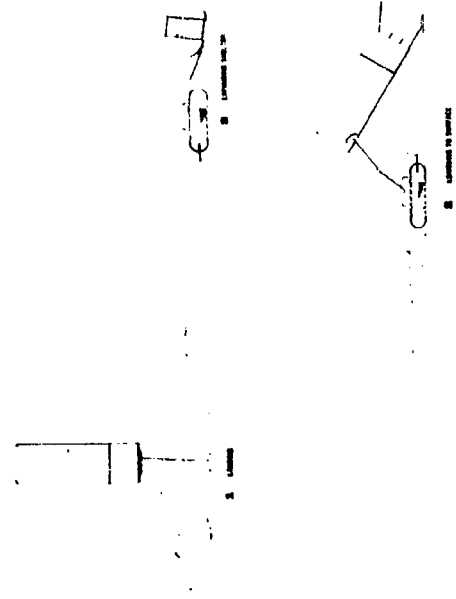

MECHANICAL EQUIPMENT AND STORAGE AREA

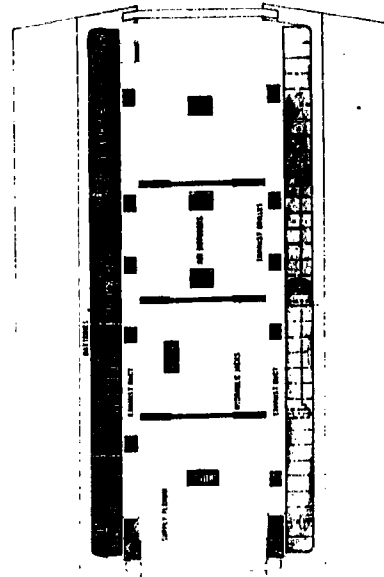

SECTION ABOVE CEILING

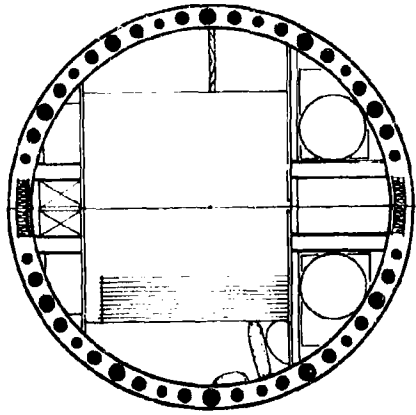
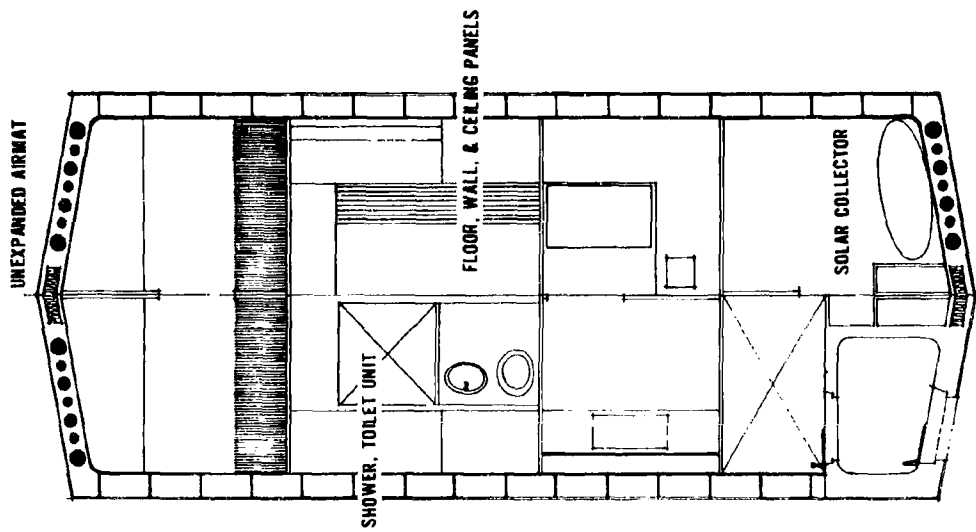

LUNAR SHELTER - PACKAGED CONDITION

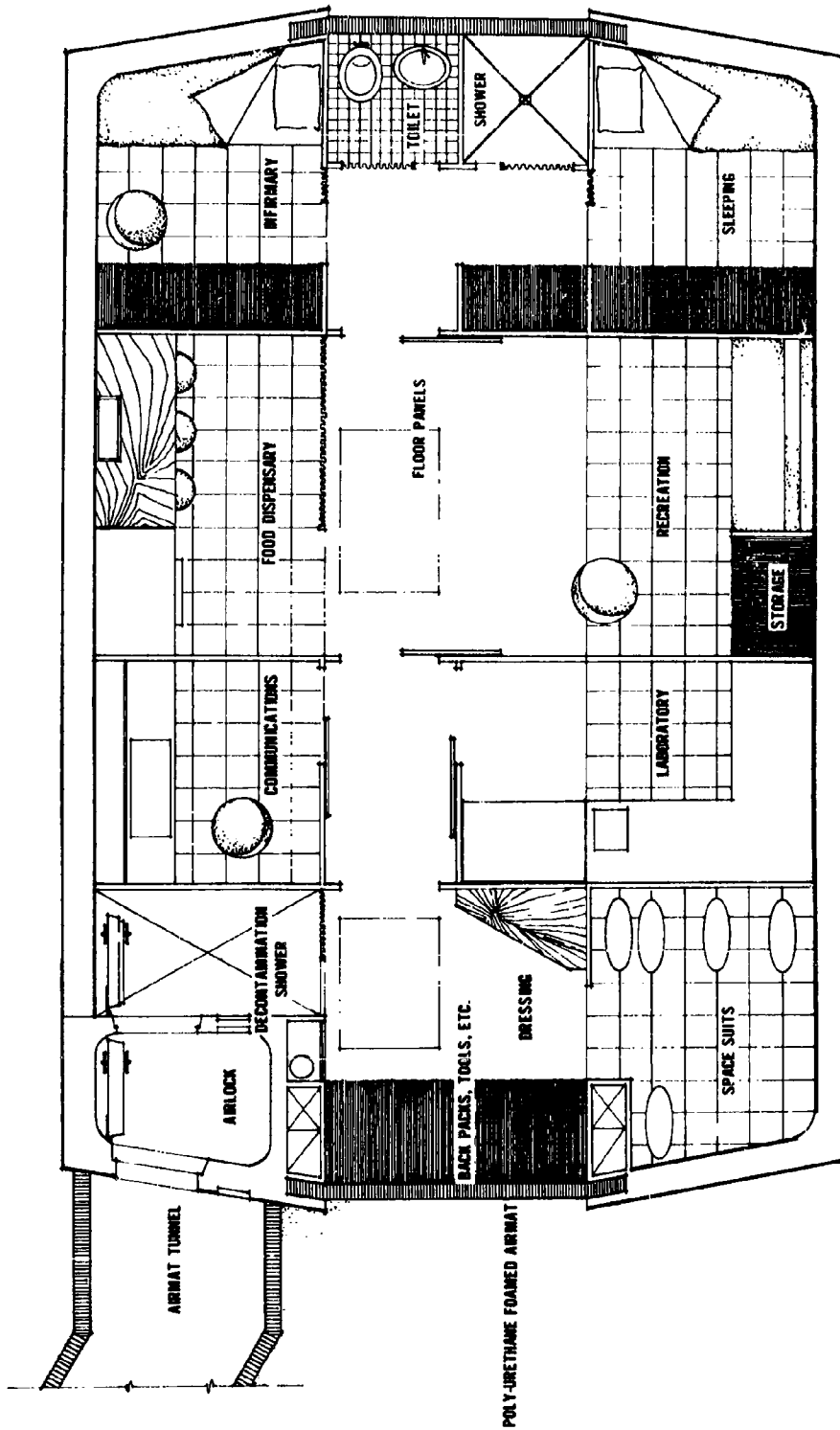

FLOOR PLAN

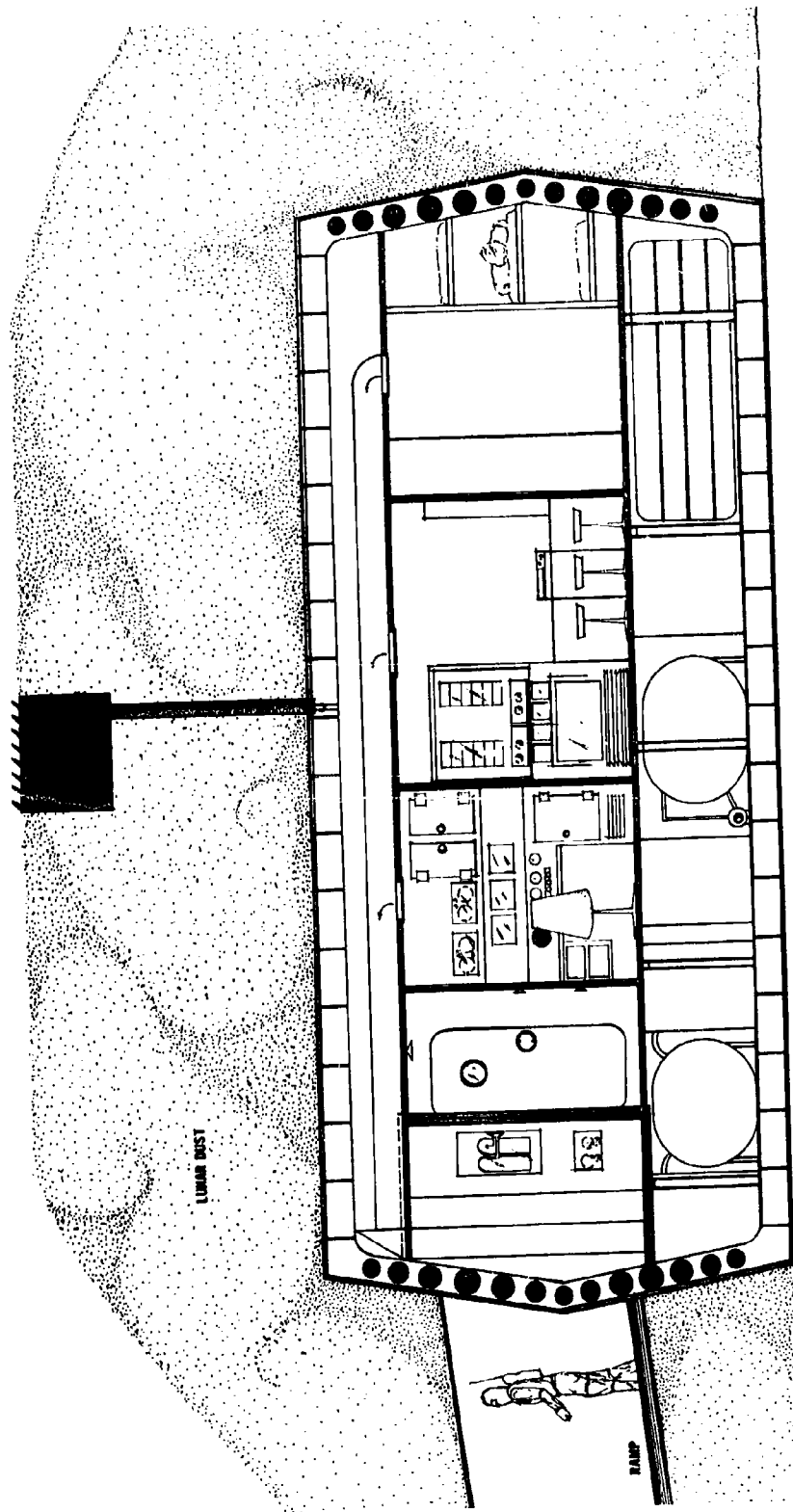

SECTION A-A

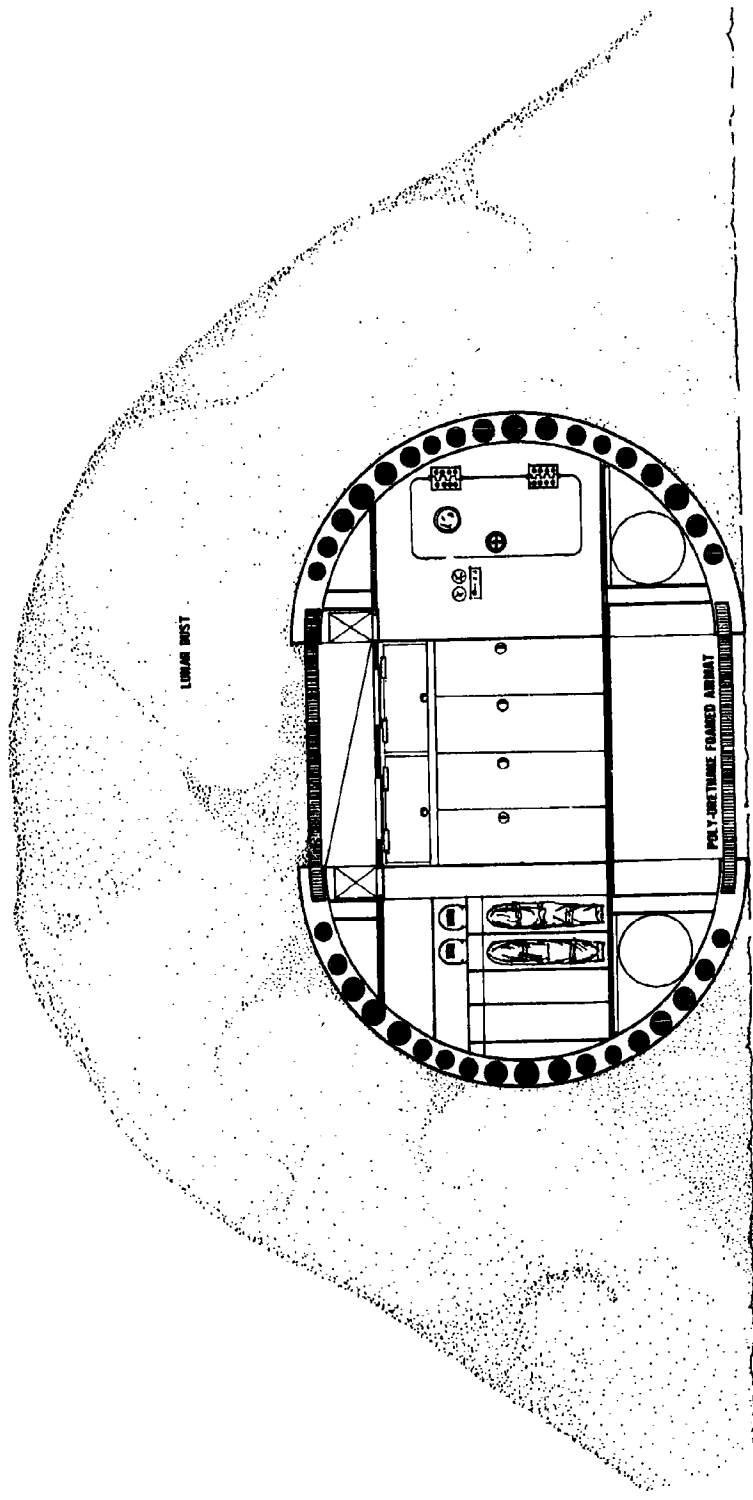

SECTION B-B

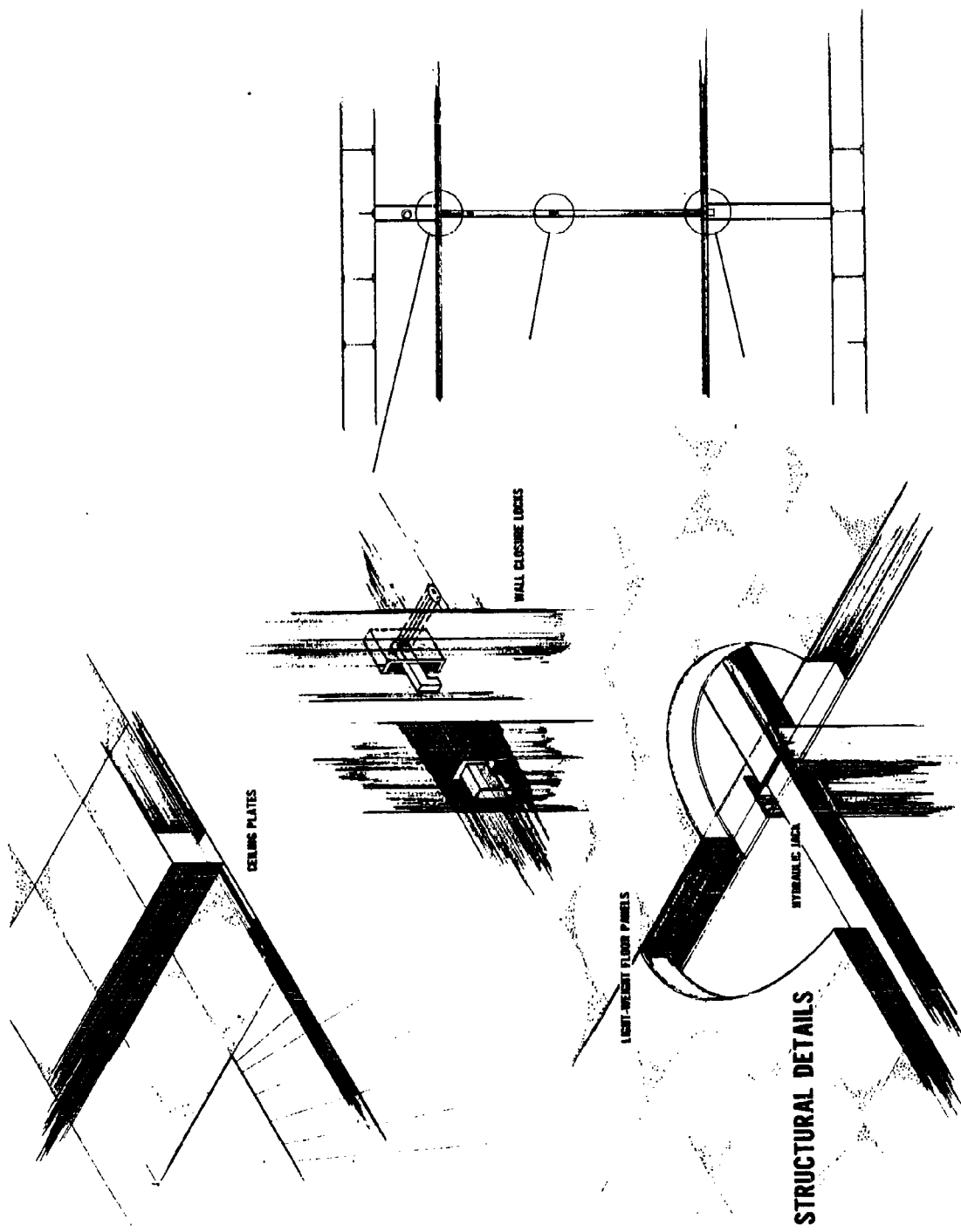

LUNAR SHELTER CONCEPTS

Lawrence L. Fabbre Industrial Design '64
Renald J. Kreinbrink Architecture '64
John S. Madzula Architecture '64
H. Patrick Thornton Jr. Industrial Design '64

1. DESIGN PHILOSOPHY

The moon is a large, essentially spherical body which moves in a slightly elliptical orbit around the earth. Its mean distance from the earth is 238,857 miles, and it takes 27.3 days to revolve once about earth. During this revolution, it turns exactly once on its own axis so that it always presents the same side to earth. We can actually see from earth 59% of its surface.

Its diameter is 2160 miles, approximately 1/4th that of earth, but its mass is only 1/81 that of of earth; thus its density is only .61 times that of earth or about 280 pounds per cubic foot. From this we derive that the gravitational attraction at the moon's surface is only 1/6th that on the earth's surface.

The environment of a building on the moon differs markedly from its environment on earth. The moon has no observable atmosphere. There is no haze, cloud formations, rains, or snow. The structure is either bathed in intense sunshine or looks upon stark, black space. The moon, having no absorbing atmosphere can feel the full force of the sun's rays and become extremely hot on one side while the other side will have quickly radiated its heat into space and become exceedingly cold. Any structure placed on the moon must be able to withstand these extreme temperatures and especially the tremendous temperature gradients.

The ultraviolet radiation, normally absorbed by the earth's atmosphere, will be sufficiently intense to render panes of glass or plastic useless as windows.

The moon is continually bombarded by particular matter:

Cosmic rays, charged particles, and meteoric particles. Extraterrestrial materials exist in three forms: inter-planetary dust which forms the zodiacal light, debris from comets or meteors, and lastly meteorites. Micrometeorite particles occur in storms at a great velocity which prove dangerous to any exposed structure.

We assume the following:

1. That the location of the building on the moon will be fixed.
2. That the building will be constructed from materials brought from earth.
3. That it will be a permanent-type building in the sense that it will be occupied on a continuing basis for several years.

Because the gravitational force is only $1/6$ as great as that of earth, a whole new field of design is opened up. It is as if we had an exceedingly high-strength, light-weight construction material. The reduction in gravity will influence the convective flow of air and the rate of flow of liquids downhill. These changes are likely to become important in our heating, power, water, sewage, and ventilating system.

On the moon we will be able to play gravitational forces against the air pressure forces, achieving some kind of equilibrium which may gain us an advantage. Broad expanses of curved structures can be used, but the whole must be held together by some means so that the air pressure within the structure will not blow the unit apart.

Rapid, intense heating and sudden, severe cooling present difficult design problems. The parts of the structure becoming

shaded will immediately become very cold, while those in the sun will remain heated to a high temperature. To control this heat we feel that the method of covering the structure with existing lunar material plus having the outer skin of the structure a highly reflective material, such as a foil. The black and white bodies, which will be used to absorb and give off heat respectively, will be connected directly with our heating and ventilating systems.

The bombardment of meteoric matter is serious but will be dealt with by our covering of the structure with the lunar material.

Assuming that the moon's surface is sufficiently solid, it will provide normal support for the building.

We feel that the shape of our units most efficiently uses the package space, module approach, area sealing devices, expandable approach, automatic erection, maximum safety, simplified mechanical equipment operation and controlled noise areas.

Our philosophic ideas here explained will be further discussed under the following topics.

2. PACKAGE AND ERECTION TECHNIQUES

In the packaged state each unit is supported separately. This enables the ship to control the position of its payload; also it insures that no one unit supports any more than its own weight under acceleration.

The method of packaging the ship consists of sliding each unit down vertical tracks to a position where it will be locked automatically and be supported individually. Upon the completion of packing, the nose cone is set in place. The unpacking process is the reverse by use of the traversing vehicle.

Erection of the units shall take place near the perimeter of a small crater. The site shall be graded level by the vehicle and the air lift hole shall be excavated by the vehicle before the air lock unit is positioned. The first unit to be positioned is the air lock unit with the mechanical and unit connectors hinged at its base. When removed from the ship, the units shall automatically expand vertically and lock into position. The remaining four units are positioned and connected to the air lock and each other by the mechanical and unit connectors. The air lock is the first unit to be expanded horizontally. This enables the removal of the expandable solar collector, generator, and white and black bodies, for their erection. The prime interest is the operation of the mechanical equipment for the function of all units before their final expansion.

Inflation of the air mat structure follows the operation of mechanical equipment. This enables correct alignment and check for air leaks in all units. The air mat and rigid panels are then rigidized from within by actuation of pellets of expandable foam.

Upon rigidizing of all units, a structure of stabilized lunar material shall be poured over entire complex by the traversing vehicle. The vehicle shall be capable of stabilizing the lunar material with foam and ejecting this material to a depth sufficient to aid the support of the remaining cover material. The total covering shall consist of approximately 2 feet of stabilized lunar material and 8 feet of existing lunar material.

During the covering process, part of the team will be in the complex placing floor sections over the expanded area, positioning

equipment, wall sections, and furniture. This erection process can be handled in stages to enable work and eat / sleep cycles to begin.

3. STRUCTURES AND MATERIALS

The main structural component for each unit shall be a central core or wall between rigid floor and ceiling. Additional structure shall be provided by a layer of stabilized lunar material.

The structural materials are broken into two main categories. First is the rigid material which is molded and fabricated of a high strength, light weight material. Second, the expandable material will consist of an integration of air mat and expandable foam reactants inside the air mat.

We feel that this combination achieves the rigid and light weight properties needed in this structure.

4. FLOOR PLAN ANALYSIS

- A. Circulation is definite and direct to each unit.
- B. Each space is designed to be coordinated with its specific use.
- C. Each unit space is so designed as to afford maximum efficiency and usage.
- D. Relief from unit to unit is afforded by a common passage.
- E. Mechanical equipment is isolated from the quiet areas.

5. ENVIRONMENTAL PROTECTION

- A. Protection is obtained from 10 feet of lunar dust over the complex.
- B. Decontamination chamber is located in the air lock shaft, which affords complex and lunar surface contamination protection.
- C. Air lock unit affords dual decontamination protection in emergency.

D. Pressure suits and fire extinguishers are packed in each unit

6. INTERIOR FURNISHINGS AND EQUIPMENT INTEGRATION

Interior furnishings shall be disassembled in packaged state. Frames and cushions of seating units shall be separate components. Frames telescope horizontally so as to occupy less area in packaged state. Frames to be constructed of aluminum tubing, and cushions will be molded foam shells covered with foam rubber and vinyl. Work area will have lab working surfaced in place in packed units, and component table surfaces fold or slide out of permanent unit.

All mechanical functioning equipment is contained in mechanical unit which feeds air, water and electricity, to all other units. Mechanical unit also contains maintenance work area and tools.

Lab unit contains all equipment needed for lunar study work. All of this equipment is packaged within the unit.

The eating and recreation unit houses all equipment necessary for food preparation and recreation.

The sleep, dress, and hygiene area houses clothing locker units, sleeping surfaces, linen, and medical supplies.

The airlock unit, while packaged, stores solar collector and generator. After expansion, this unit will house space suit storage.

All equipment to be used in different units is packaged directly in that unit and need not be moved after expansion and setup of interiors takes place.

7. STATISTICS

Entire Area

a. 1310 sq. ft.

b. 10,480 cu. ft.

1. Air Lock

- a. 262 sq. ft.
- b. 2,096 cu. ft.

2. Mechanical Equipment

- a. 262 sq. ft.
- b. 2,096 cu. ft.

3. Lab Area

- a. 262 sq. ft.
- b. 2,096 cu ft.

4. Rest, Dressing and Hygiene

- a. 262 sq. ft.
- b. 2,096 cu. ft.

5. Eating

- a. 88 sq. ft.
- b. 699 cu.ft.

recreation

- a. 174 sq. ft.
- b. 1399 cu. ft.

8. THEORETICAL ADVANTAGES OF THIS CONCEPT

The advantages of our concept begin with the shape of our units. They conform to the lunar package readily along with their adaptability to modular construction and efficient future expansion.

In their packaged state, they house all equipment needed in expanded, functioning state. Expansion of units is almost completely automatic. The units expand vertically upon removal from the space ship. After they are positioned by mechanical and unit connectors, the horizontal expansion is done by inflation and

actuation of foam. This we feel to be an efficient method occupying a short period of time. Covering the entire complex with stabilized lunar material adds strength to our structure, and actually becomes an integrated structural member. After this material is in place, the rest of the covering process can be done in stages. By covering our complex, we feel we can achieve the maximum protection from great radiation and micro-meteorite storms. The only vulnerable spot in our entire complex is the outer hatch which heads into our air lock unit. A safety factor is provided here in the lower hatch. Also, each unit becomes an air-tight compartment whereby, if one component is damaged, it can be sealed off from the rest of the units. Little structural damage is expected. However, due to the placement of the complex under 10 feet of lunar material, the outer hatch on the airlock unit is so designed that our transversing vehicle may be parked directly over it and access to and from it can be achieved without having a pressurized space suit on. The vehicle will be in this position whenever it is not in use to give added protection to upper hatch. We feel that protection from the lunar environment and quick escape factors have now been provided.

Each unit of the complex is designed to carry out a specific function or functions. Each unit is accessible thru a hallway in the outer air lock unit. Noise producing units have been separated from areas of rest and recreation.

The Physical change of passing from one unit to another through this hallway provides for a psychological change. Though the man is entering another similarly outer shaped unit, he is not aware of this because of interior treatment of space and color. Also

because the exterior is not visible, his awareness to shape of units is minimized. Another psychological consideration is achieved by covering the structure and providing a feeling that it cannot be punctured.

Food becomes an important psychological consideration because of its ability to relate to the earth's environment. Food will be packaged so that the individual may choose his own menu. Preparation will merely mean plugging each packaged meal into a water and heat receptacle. It can be eaten from this same package and any leftovers will remain in package and be replaced in refrigerator where it will be chemically treated, the original package now becomes the waste package.

Recreation is also an important consideration. We have provided an area for both reading / listening types and physical type. This area can be used for either or both types of recreation. Physical recreation is important because it is the method by which the individual can attain his physical fitness need. Some predetermined schedule of exercise will be provided to insure proper fitness.

Each unit will be communicable by an intercom system. The work-lab unit will have a television monitor as part of its communication equipment. This monitor will give a picture of the entire area around the shelter. Lighting will also be provided outside so that during the lunar night a constant observance of the surrounding area can be made.

Consideration has been given in our concept to future expansion. As this unit will be a permanent structure, other units can be directly attached to the original units making a

growing complex. Food storage, air tanks, water, and clothing storage units are so designed that they may be replaced in the future (i.e. at the end of each team's stay on the moon).

Checked against available research material, we feel that this concept is a feasible solution to man's lunar environmental needs.

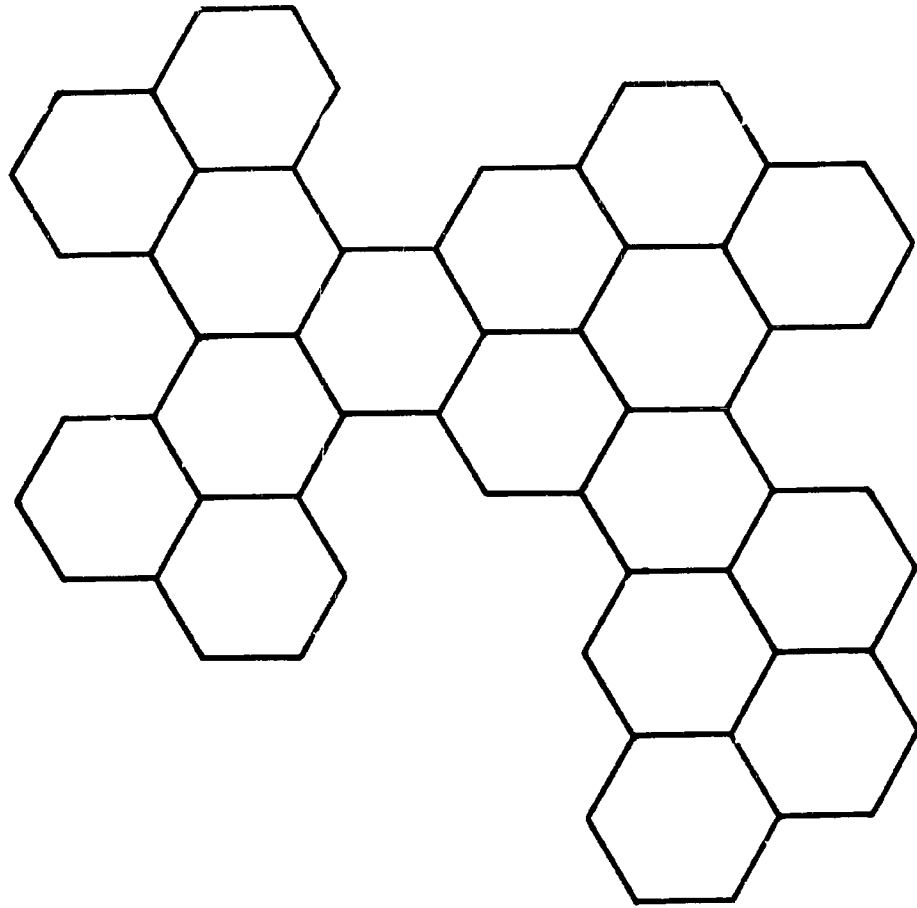

LUNAR SHELTER

FABRO
KREINBRINK
MADZULA
THORNTON

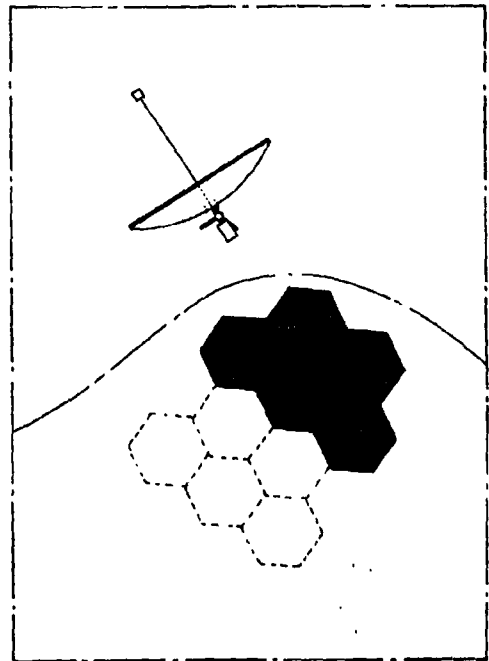
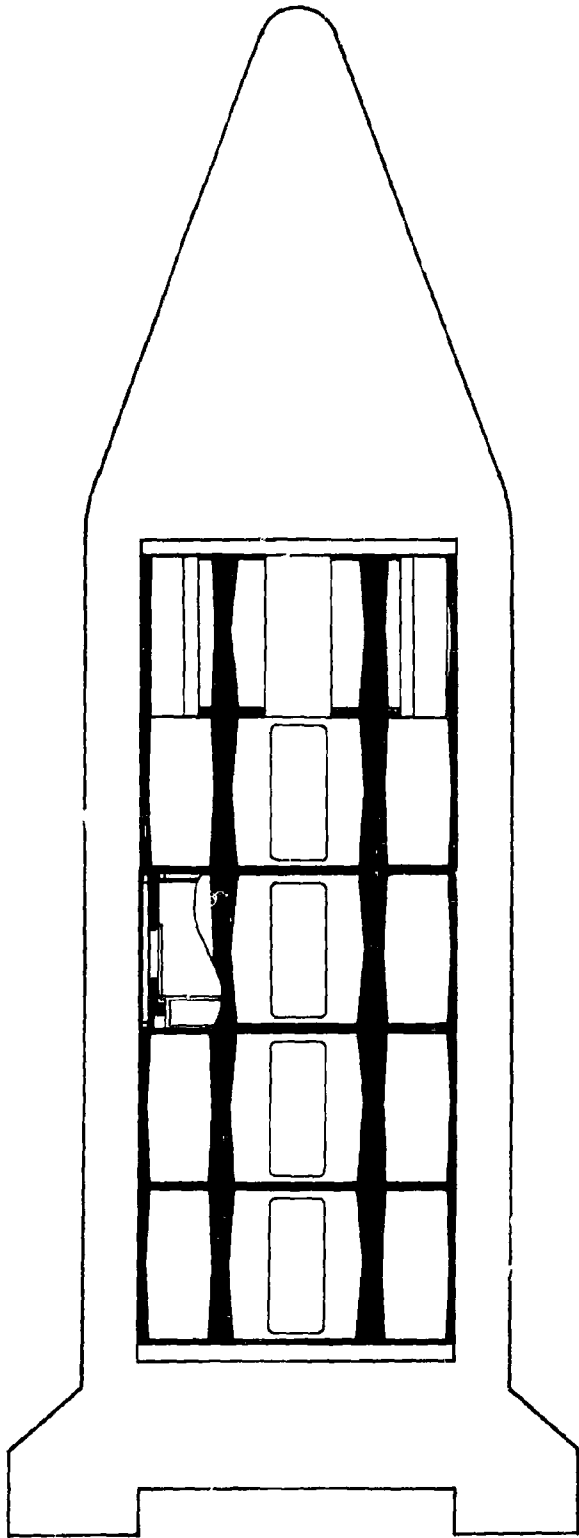

SITE PLAN
SCALE · 1"=20'

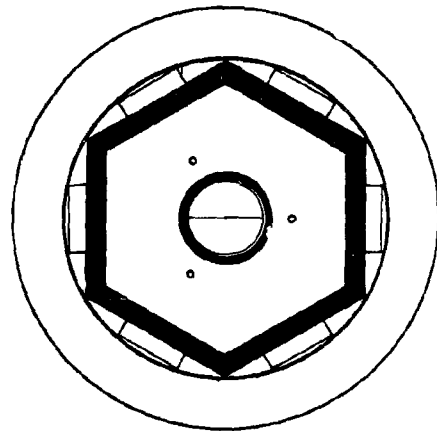

PACKAGED SHELTER

MECH. EQUIP. UNIT 1.

- 1. WATER (STORAGE & PUMP)
- 2. HEATING
- 3. WORK BENCH - TOOL STORAGE
- 4. AIR SUPPLY
- 5. ELECTRICAL SOURCE
- 6. REFRIGERATION EQUIP.
- 7. FLOOR SECTIONS

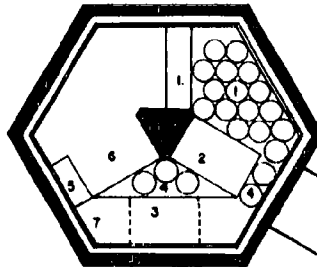

AIRLOCK UNIT 2.

- 1. LIFT
- 2. AIRLOCK DOOR
- 3. CONTROL PANEL
- 4. GENERATOR
- 5. SOLAR COLLECTOR
- 6. ADD. COLLECTOR STRUCTURE
- 7. INNER HATCH
- 8. WALL PANELS
- 9. FLOOR SECTIONS

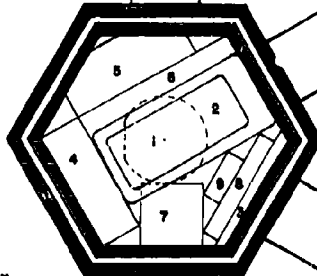

SLEEP-HYGIENE UNIT 3.

- 1. SHOWER
- 2. LAVATORY
- 3. WATER CLOSET
- 4. WASTE REFRIG.
- 5. CLOTHING STORAGE
- 6. END WALL CABINETS
- 7. BEDS
- 8. CONSOLE
- 9. WALL PANELS
- 10. FLOOR SECTIONS

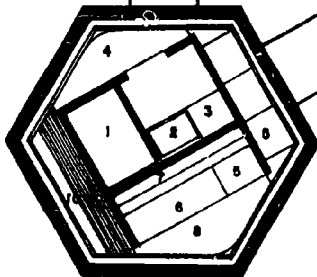

4. WORK UNIT

- 1. END UNITS
- 2. LAB. DIVIDERS
- 3. FLOOR SECTIONS
- 4. CHAIRS
- 5. WORK SURFACES
- 6. KNOCK DOWN WALL UNITS

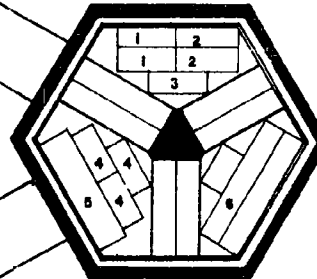

5. EAT-RECREATION UNIT

- 1. FOOD STORAGE
- 2. FOOD PREP.
- 3. REC. EQUIP.
- 4. CHAIRS
- 5. CAB. UNITS
- 6. TABLE
- 7. FLOOR SECTIONS
- 8. STORAGE

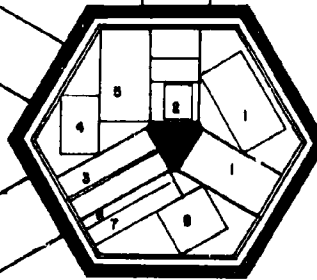

SCALE 1/4" = 1'-0"

SET-UP PLAN

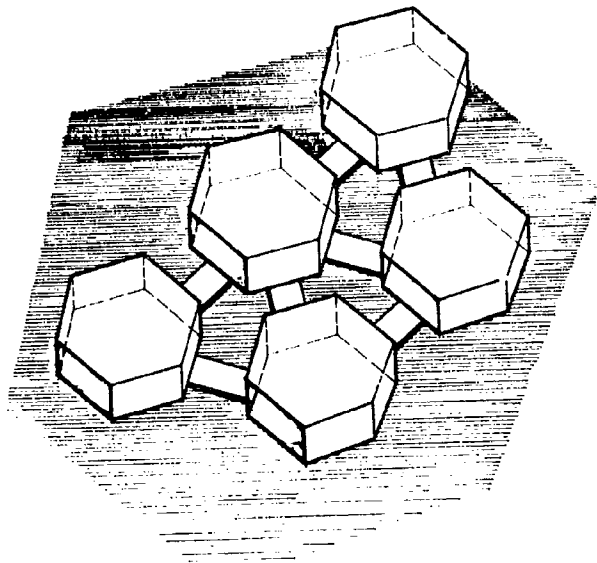

FIRST STAGE

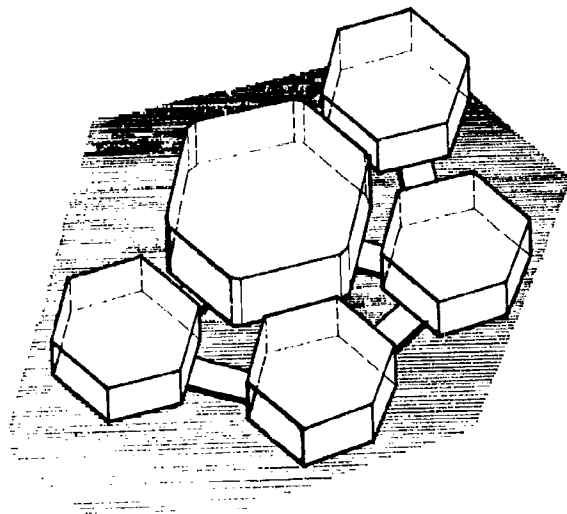

SECOND STAGE

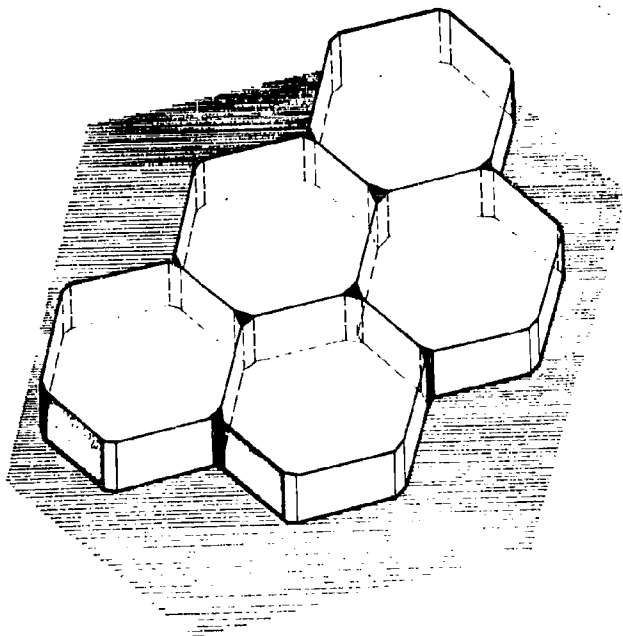

THIRD STAGE

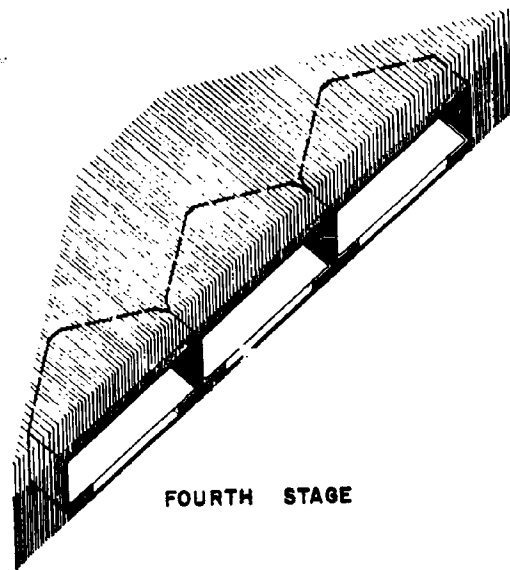

FOURTH STAGE

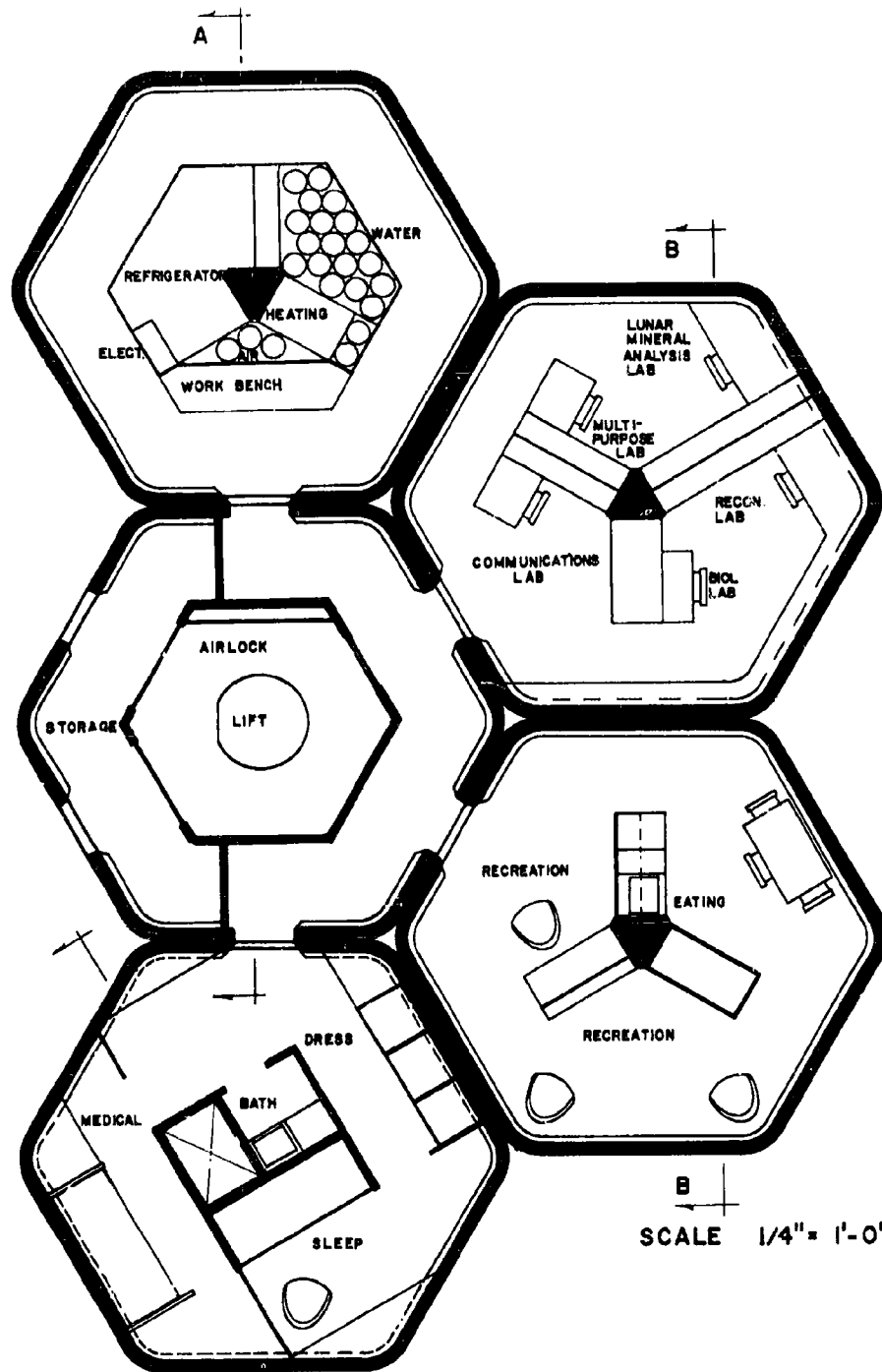

A
EXPANDED PLAN

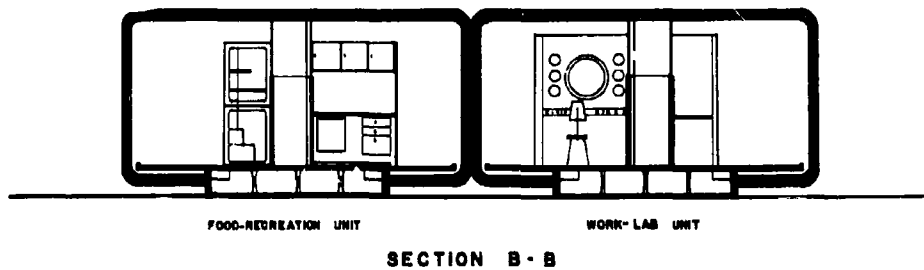
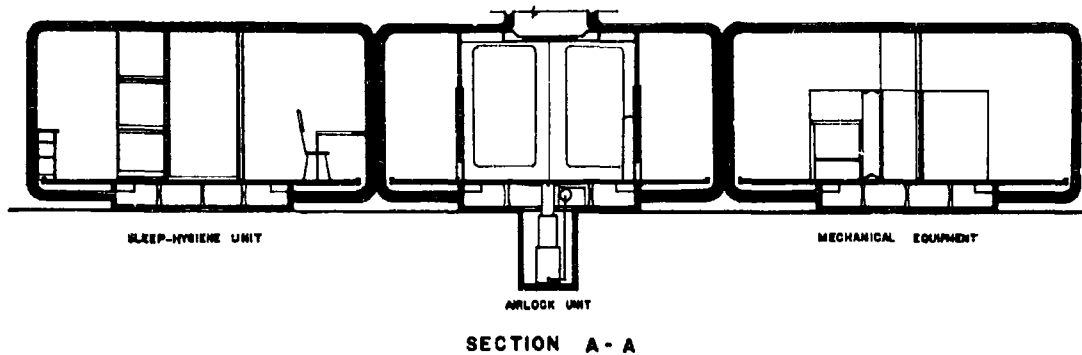

SCALE 1/4" = 1'-0"

SECTIONS

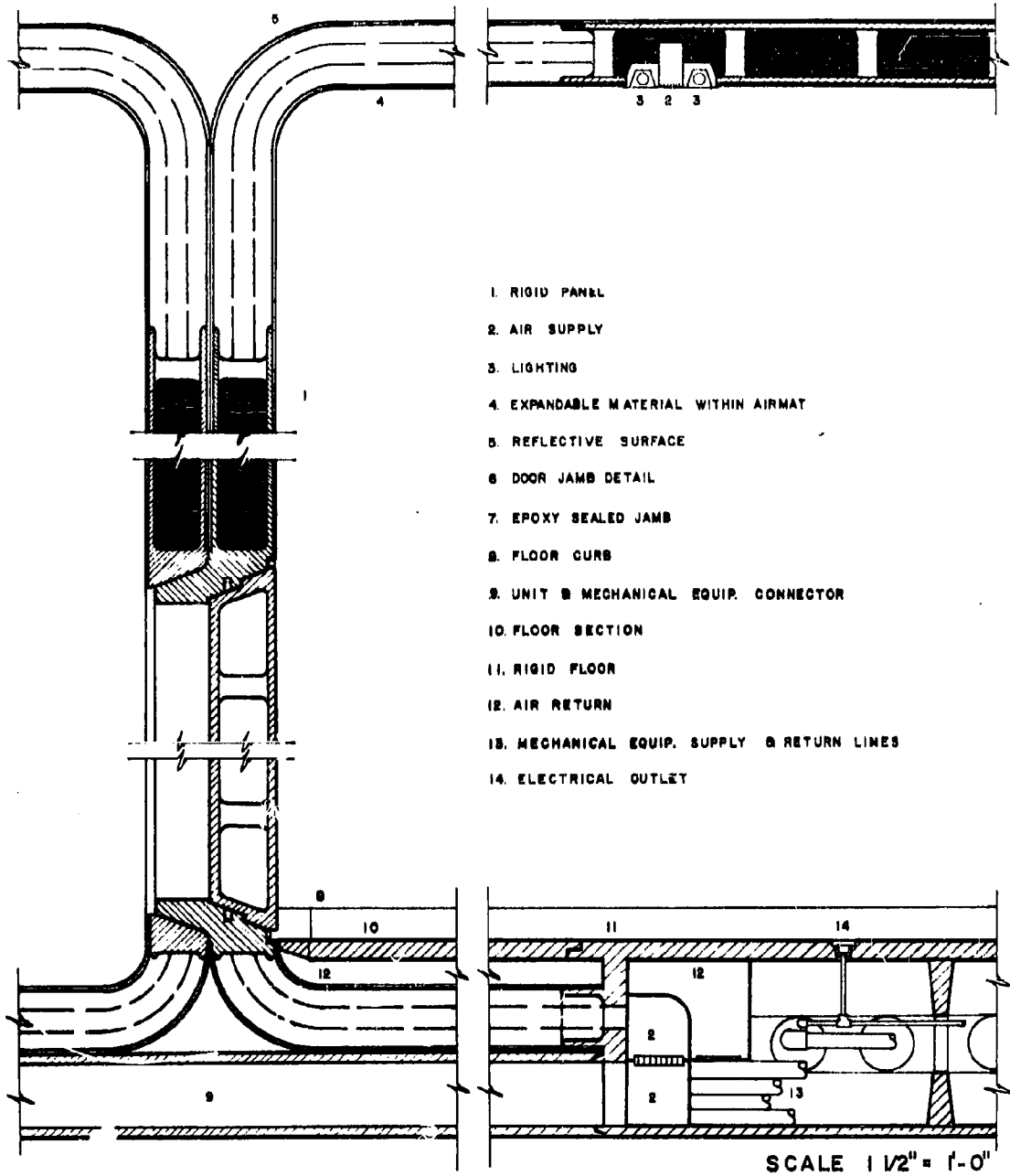

STRUCTURAL DETAIL

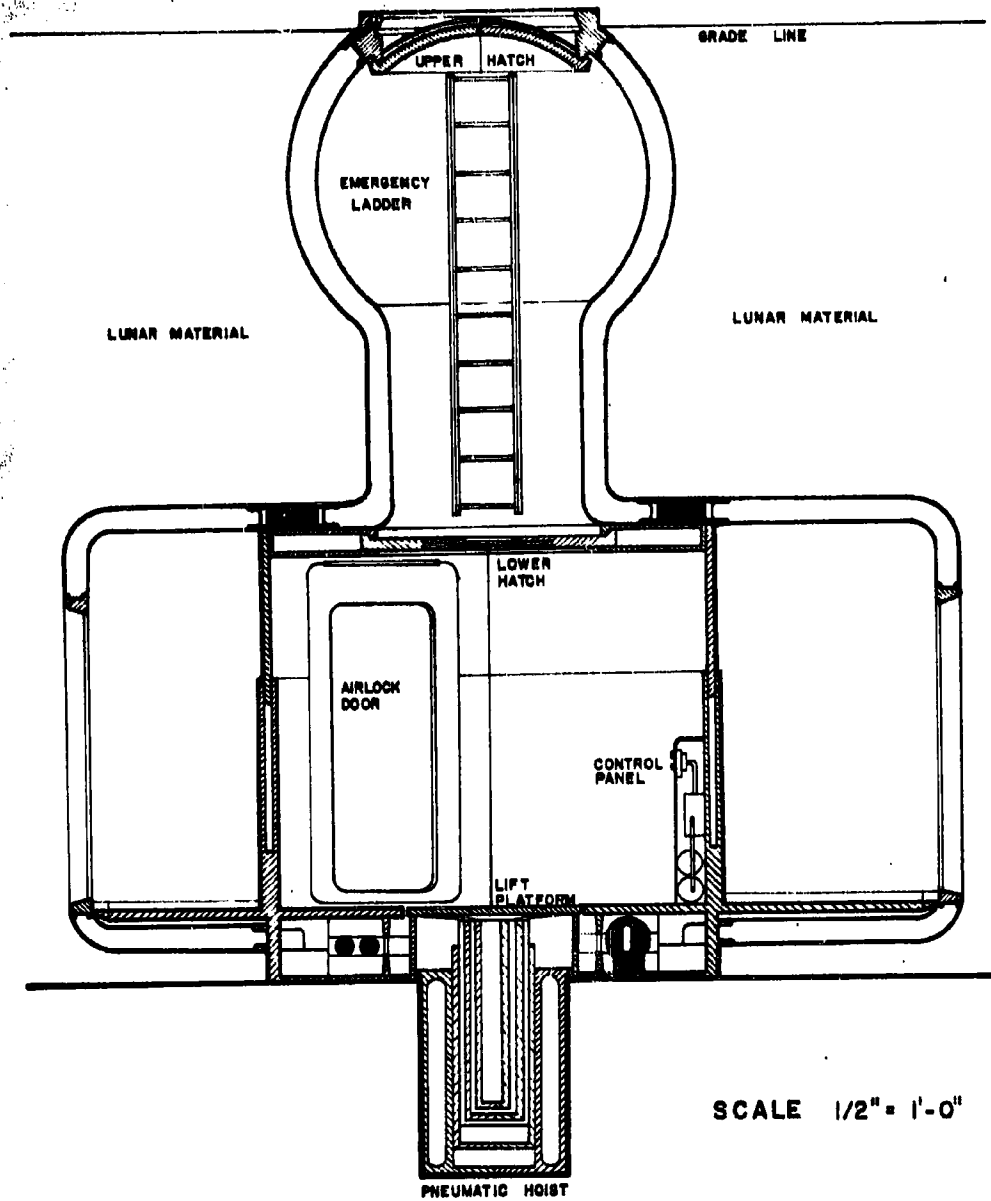

AIR LOCK & LIFT DETAIL

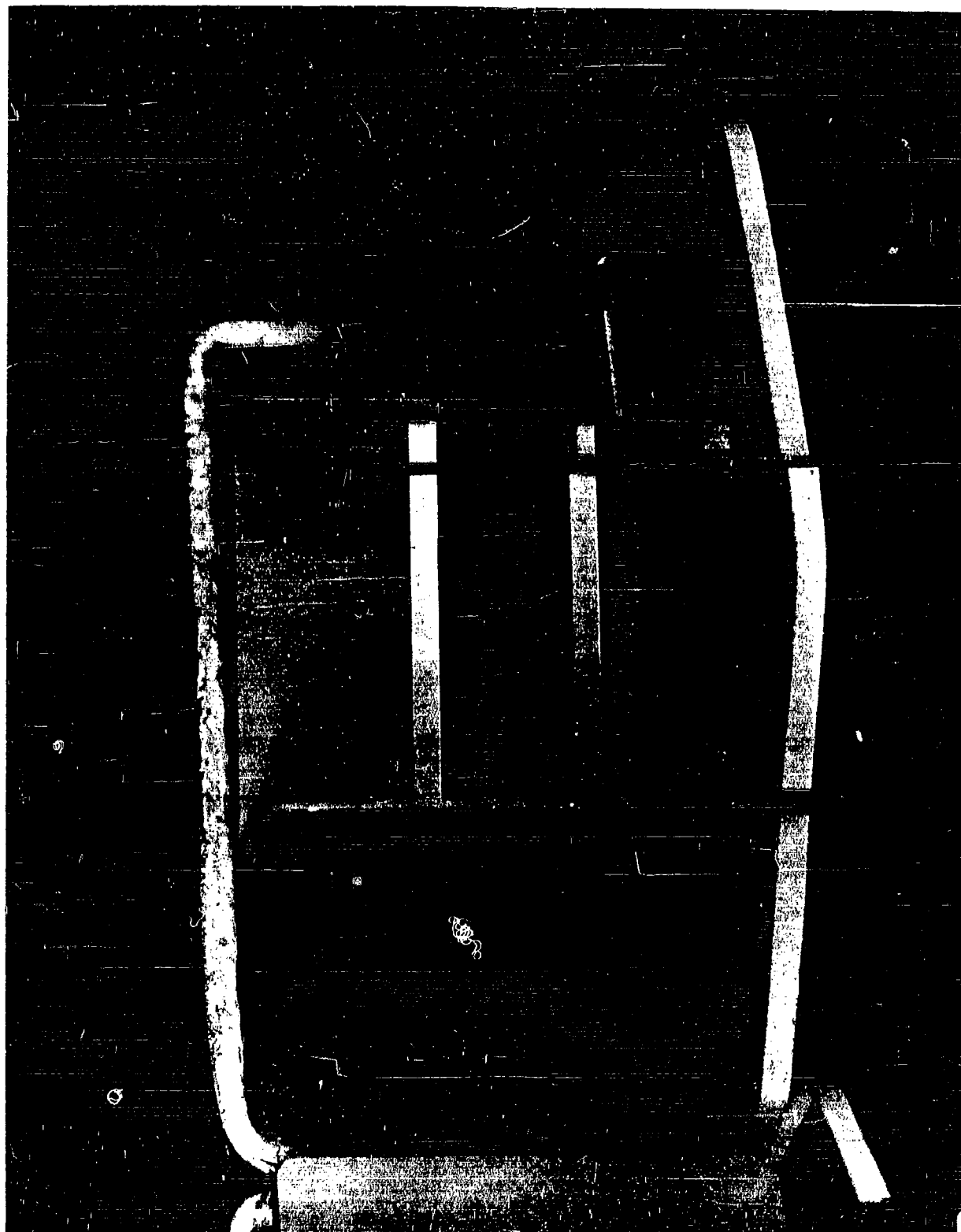

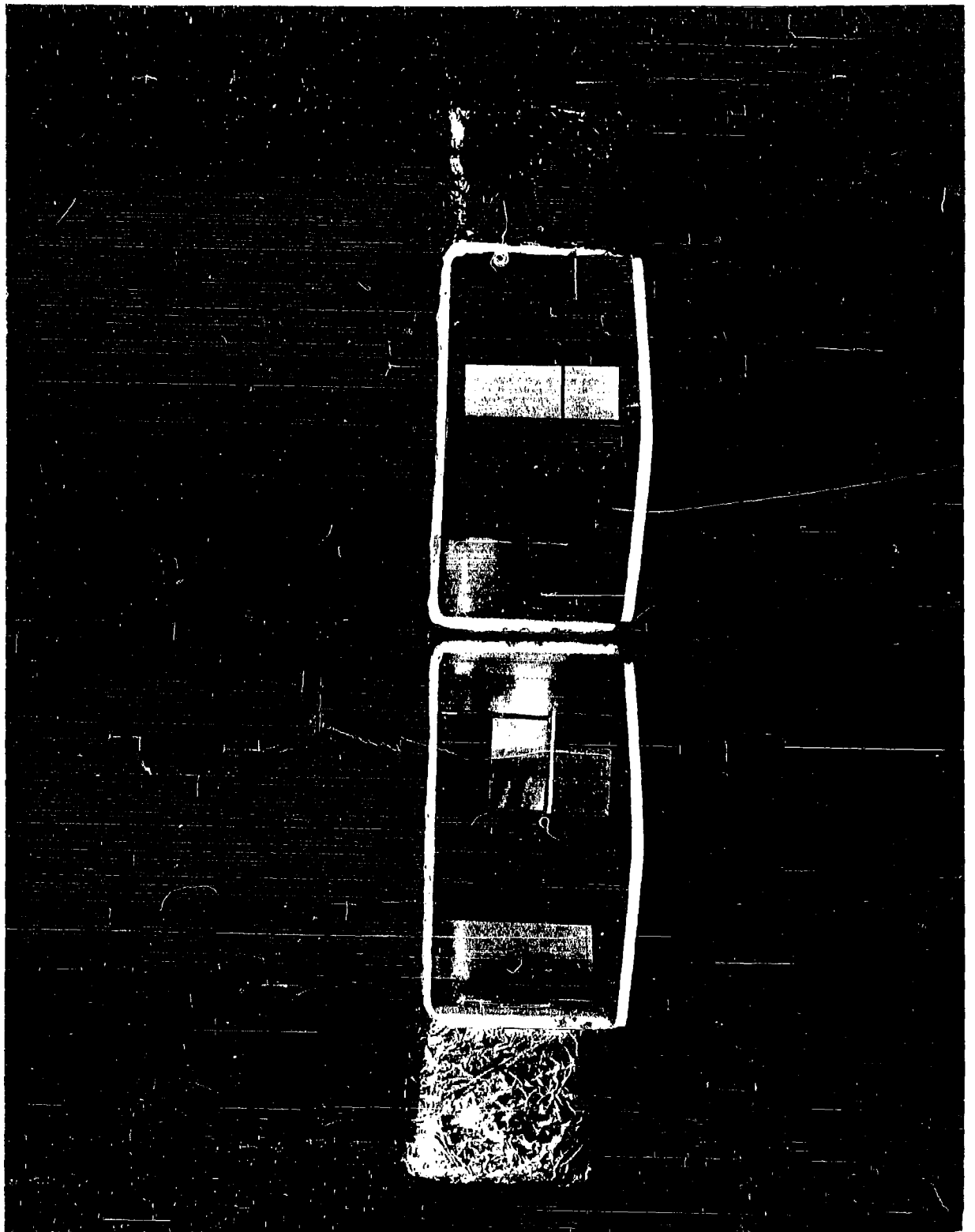

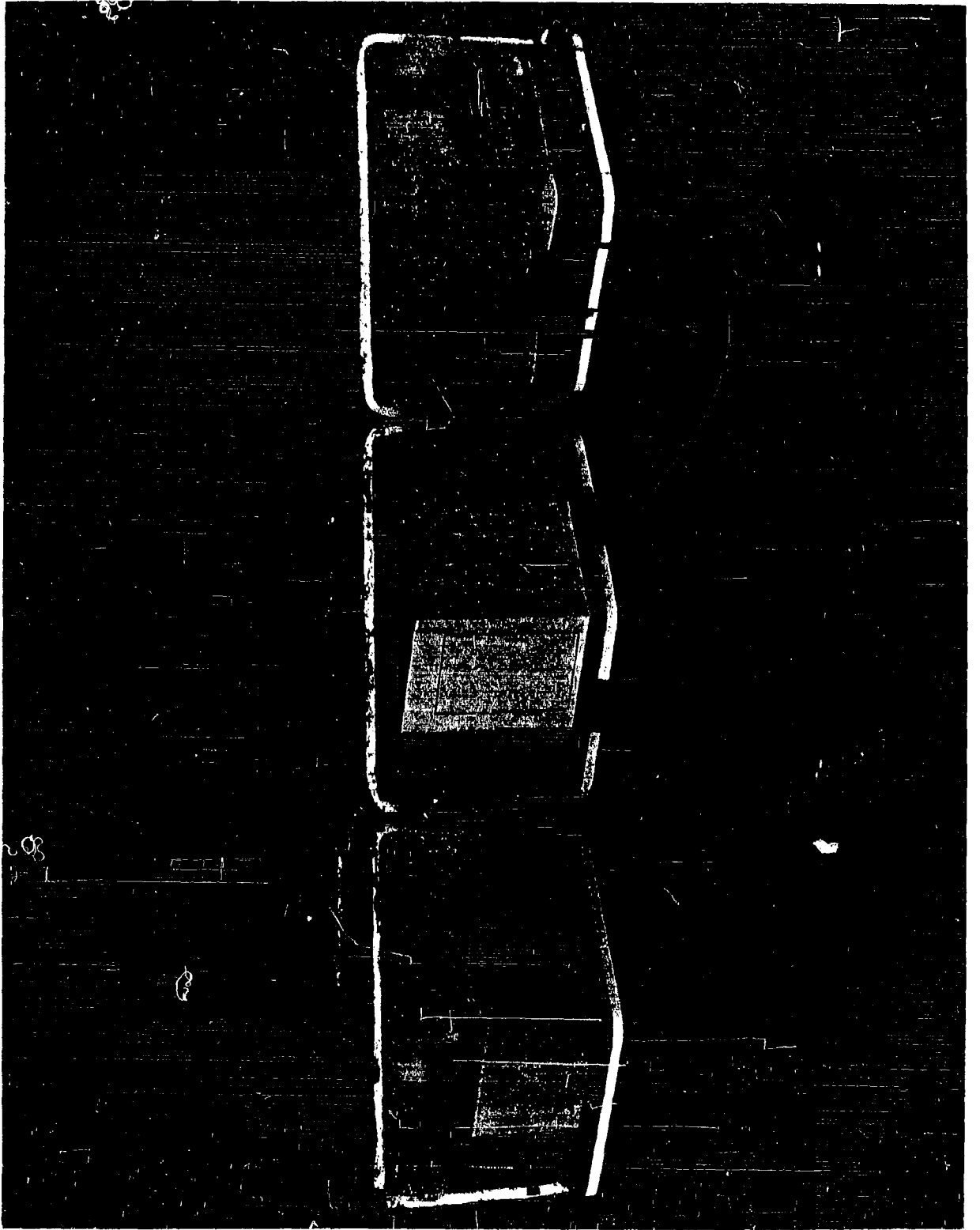

LUNAR SHELTER CONCEPTS

CARL N. ELLIOTT	ARCH.	1964
WILLIAM R. HOEB	IND. DES.	1964
DENNIS L. REINKE	ARCH.	1964
SALLIE E. WIEGAND	IND. DES.	1963

DESIGN PHILOSOPHY

The team has used the 14 X 35 ft. cylinder as the living quarters. It is broken down into five separate cylinders with four of these 8'-0" high for the living and working quarters and one 3'-0" high containing the power unit. The four main cylinders are unstacked, butted together, and connected with an X-shaped rubber hallway. The power unit is centered over the top of the walkway connection and protects this area from lunar dust. It too is connected to the rubber hallway so that the unit can be serviced easily from below. The entire shelter is then covered with ten feet of lunar dust. The solar reflector is a Goodyear Inflatable Airmat which is self-rigidizing after erection.

PACKAGE AND ERECTION TECHNIQUES

The cylinders are stacked top to bottom in the following order: Sleeping and Bath Area, Kitchen-Recreation Area, Main Laboratory Area, Air Lock and Secondary Laboratory Unit, and the Power Unit. This arrangement puts the heaviest units on the bottom of the main cylinder and will be quite stable in landing.

The individual cylinders are loosened from each other by explosive bolts. The top row blows first and the top unit is lifted off with a crane attachment on the earth moving vehicle. Then the next row of bolts blows off and the second unit is removed and set tangent to the first. After the third one is set in place, the inside equip-

ment that has to be removed for use outside is taken care of. The rubber walkway is fastened to the three doors and the fourth cylinder is attached to it from inside the shelter. The power unit is lifted on top and also sealed to the inner hallway. The shelter can now be pressurized as soon as the power is turned on. The telescoping tunnels are connected to the airlocks, and the entire structure is covered with ten feet of lunar dust.

STRUCTURES AND MATERIALS

Cylinder -- double steel wall, two inch air space on side walls, four inch space between ceiling layers and three inch space under floors.

Interior floors -- cork tile

Interior walls -- acoustical board

Solar reflector -- self-rigidizing Goodyear Airmat

FLOOR PLAN ANALYSIS

The shelter has four separate circular floor areas or rooms:

1. The air lock, decontamination equipment, space suit storage, and the mineral and biological labs are in the first cylinder. These particular lab areas were placed near the entrance since they will deal with materials brought in from outside.
2. The bath and sleeping areas are in another room. There are three bunks for sleeping and two for emergency sickness. These areas can be isolated if necessary and are completely sound-conditioned.
3. The kitchen and recreation facilities have been grouped in a third room. It has been left open in the center while the rest of the areas are fairly well filled.

4. The other labs and communication equipment have been placed in the fourth cylinder. Each has been assigned to a certain section of the circular work unit attached to the outside wall. An emergency airlock has been provided for use in the event of a failure in the main one.

ENVIRONMENTAL PROTECTION

The shelter will be covered with ten feet of lunar dust. This will protect from all radiation, the extreme heat and cold, and meteoroids. Black bodies and radiators will be placed around the structure outside. There will be 10psi atmosphere inside the shelter. An airlock, decontamination chamber, emergency airlock and a completely equipped first aid area are built into the design.

INTERIOR FURNISHINGS AND EQUIPMENT INTEGRATION

The bathroom, sleeping and first aid areas are all in one unit. There are nine lockers, one for each man, in the main sleeping area. A drawer is at the bottom of each for shoes. Smaller drawers are provided in the middle. The two large compartments in each locker are covered with plastic doors which slide up and down in tracks in the same manner as a roll top desk. The three bunks are made of 1 1/2" aluminum tubing covered with nylon netting and are permanently fastened down. This area is painted light green. In the sick bay there are two bunks of the same type which can be folded against the wall and a TV nurse unit at the foot of each. Medical supplies and surgical instruments are kept in storage space along the wall and under the

bunks. This area is blue-green as in the bathroom. It and the other bedroom can be shut off from the bath by folding doors.

The bath fixtures are molded in one piece of plastic. On the wall opposite the fixtures is a large mirror which helps add size to the room. Under the mirror are folding benches and above it, a folding shelf. Ample storage space has been provided around the walls for soap, towels, bedding, shaving supplies, etc. The shower works on water vapor and has a blower unit for drying without the use of towels. There is also a small blower for drying the hands. The fixtures are located under the power unit for easy access to the water supply. Water is reclaimed by a heater evaporation process after having been forced back up to the power unit with compressed air. The solid waste is sent up to the solar reflector and burned.

The main lab area has counter space around the wall. In the center of the room is a table which contains an automatic mapping device for spotting the location of lunar explorers. It is lighted from underneath. Hanging down from the ceiling above the table are television screens which connect to cameras outside the shelter, the sick bay, and the space station. The counter areas are green to be easy on the eyes. The communications center is located in this lab area. An emergency airlock has been provided for safe exit and entrance in case the other one should fail. In normal times it is used for storage. Other modules may be connected at this point. The ceilings are vaulted to make the equipment easy to reach.

The mineral and biological labs are located in the cylinder with

the airlock equipment. They were put near the entrance as they will deal with materials brought in from the outside. The counter top and storage space in this lab is arranged in the same manner as the main one. In the other half of the room is the air lock for three men and a decontamination chamber for one man at a time. The air lock walls are formed by the tanks of air used to increase and decrease the pressure. Space suits are stored sideways in racks along the wall which slide out into the room. Storage space has been provided for shoes, helmets and tools to be used outside. There is a central dividing, sealing wall which acts as an analysis device for lunar minerals. The lab area is reddish-brown, the dressing area is off white and the air lock is blue-green.

The kitchen and recreation area are in the fourth room. The freezer has vertical sliding racks which operate in the same manner as the space suit storage unit. The meals are pre-packaged in boxes which are put into the high-frequency infra-red oven. After heating, the halves of the box are opened and used as the plate. The canned and dehydrated items are then added to the plate. The plates and cans are disposed of through a pneumatic tube and burned in the incinerator under the reflector. The men can eat sitting on bar stools at the counter top or at a round table in the room. There are three bar stools and six chairs plus one lounge chair. The recreation area has been provided with exercise equipment, table games, hi-fi, movies, books, radio and TV (if a Telstar arrangement can be provided for the moon).

All rooms have these things in common: Cork tile of different shades is used on the floor to deaden noise. All blank wall space is covered with sound reducing board. Electroluminescent panels which cover the ceiling eliminate annoying shadows on work surfaces. We are specifying disposable clothing, bedding, and towels for the inhabitants of the shelter so as to eliminate the problem of washing clothes and for protection against radiation. Radiant heating is provided in the floors. Ventilation comes through the louvered access door to the power unit.

The top power unit contains the refrigeration equipment, oxygen and other gasses, electrical panels which slide out, odor filters, dehumidifiers, hot water heater, pumps, etc. The bottom six inches contains the wiring, pipes and other conduits necessary for hook up to the living quarters.

STATISTICAL INFORMATION

Floor area per unit	154 sq. ft.
Cubage per unit	1232 cu. ft.
Sleeping, first aid area	77 sq. ft.
Bathroom	77 sq. ft.
Total lab areas	214 sq. ft.
Total work areas	308 sq. ft.
Total living areas	308 sq. ft.
Living plus work areas	616 sq. ft.
Outside ceiling height	8 ft. 0 in.
Inside ceiling height	7 ft. 5 in.
Central hall	5 ft. 10 in sq. or app 36 sq. ft. or 288 cu. ft.
Power unit	3 ft. 0 in. high, 154 sq. ft., 462 cu.ft.

THEORETICAL ADVANTAGE OF THIS CONCEPT

The team first started with the concept of a remotely controlled automatic foaming machine which foamed shelters in place. Another concept was to lay the cylinder horizontally and expand one or both sides. We finally analyzed the actual cylinder itself and found that, while it was not what could be termed luxurious, it had sufficient room for living and working space for nine men for thirty days.

The simplest solution would have been to lay the cylinder on its side and have no assembly problems. However, it would have been difficult to tip the package over into this position since it lands vertically. Also it was hard to utilize the floor and ceiling areas efficiently. The curved walls and ceilings lessen the amount of usable area in a two floor concept, and the one floor model had too much waste storage space. Making a four or five floor shelter within the vertical cylinder had other disadvantages. It would be almost impossible to cover it with dust. It would be very inconvenient to have to keep climbing up and down and extremely hard to remove the equipment to be used outside.

Our concept gives the same floor area as the latter idea but puts it all on one floor level. The ceilings are an even height all over the room and the power unit is compact and out of the way but can be serviced easily. Connecting the cylinders by a central walkway rather than at the two points of tangency prevents the rooms from becoming hallways of traffic that would disrupt the activity within the room. There are also only half as many door openings to seal. All of the inside equipment is already in place and in working order.

LUNAR SHELTER

COLLABORATIVE DESIGN PROJECT
INDUSTRIAL DESIGN AND ARCHITECTURE

TEAM 6
CARL ELLIOTT
BULL MOSE
DENNIS REINKE
SALLY WIEGAND

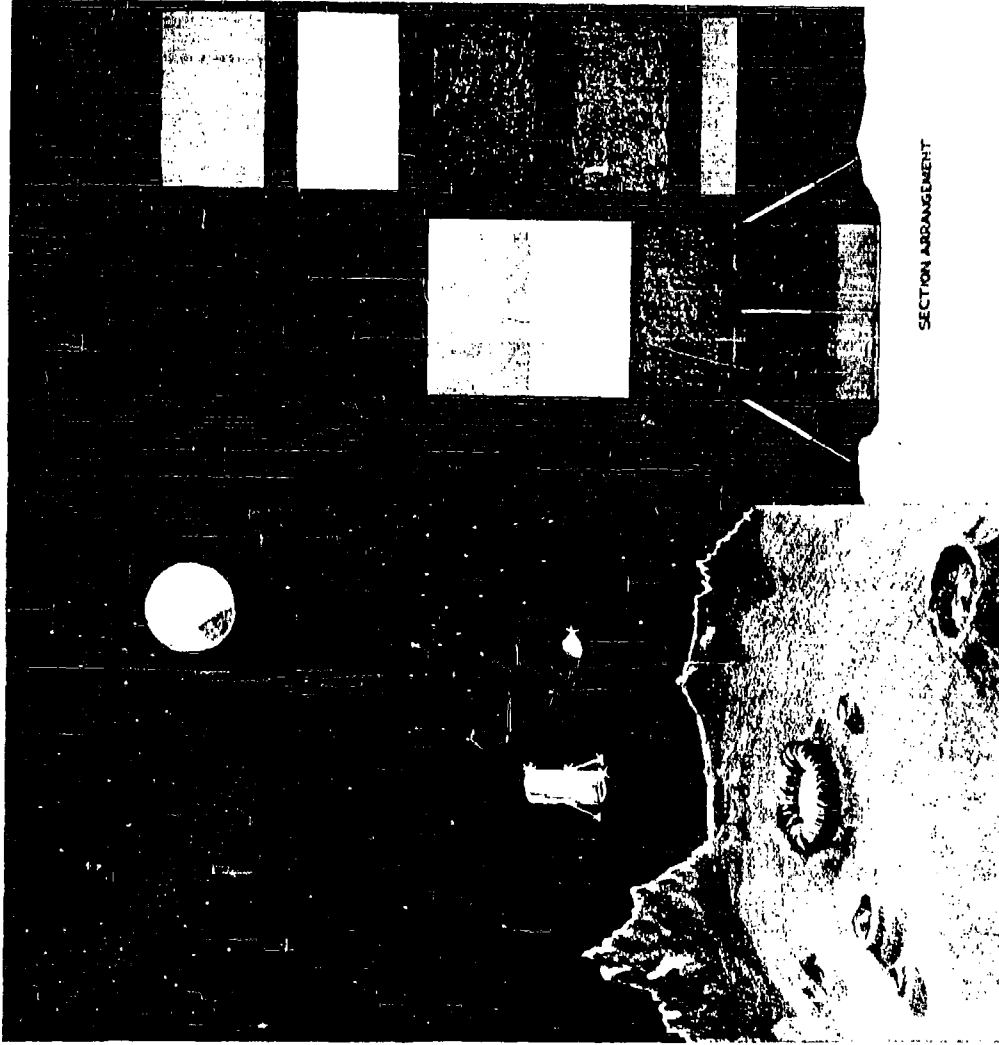

SECTION ARRANGEMENT

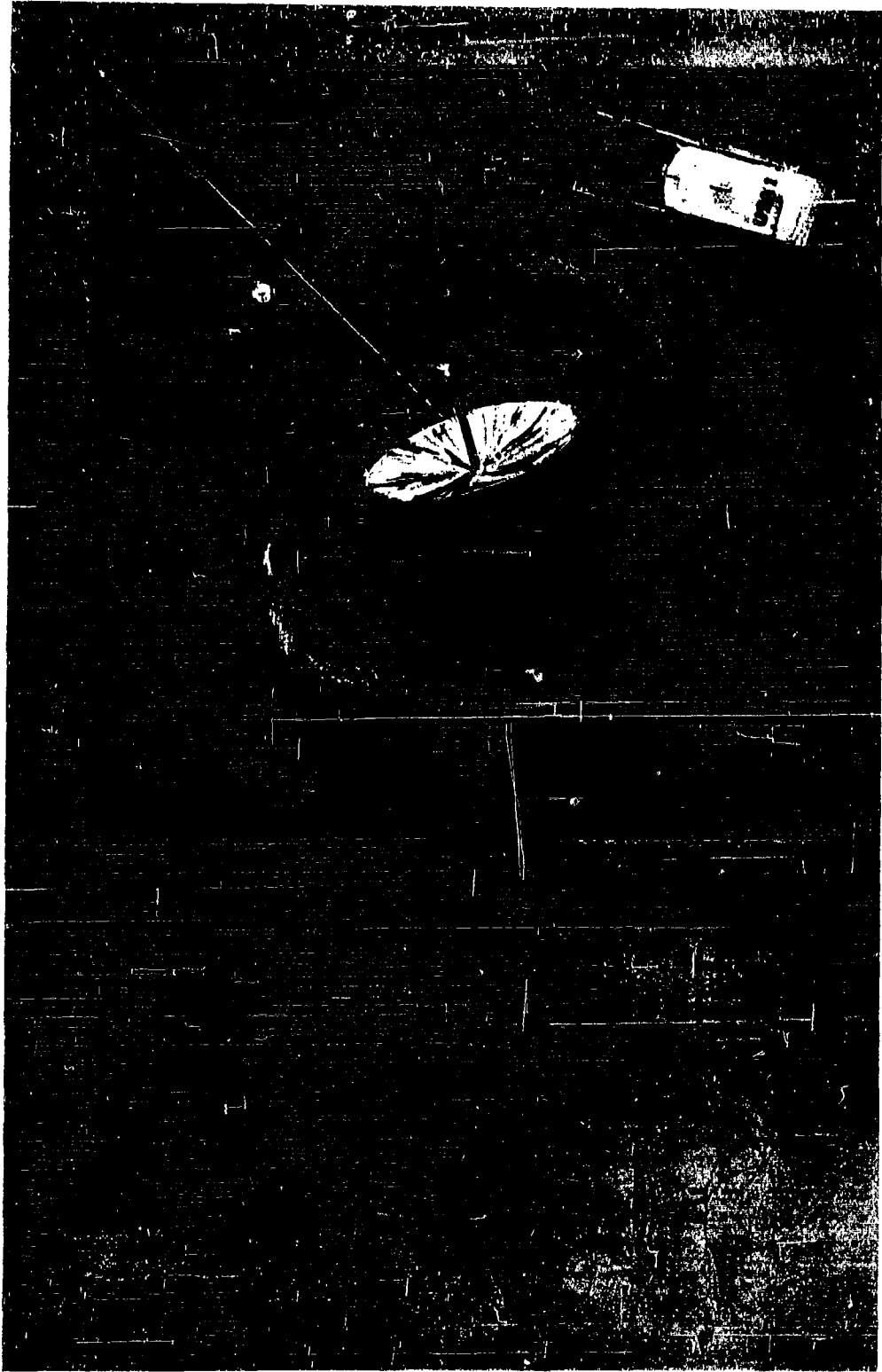

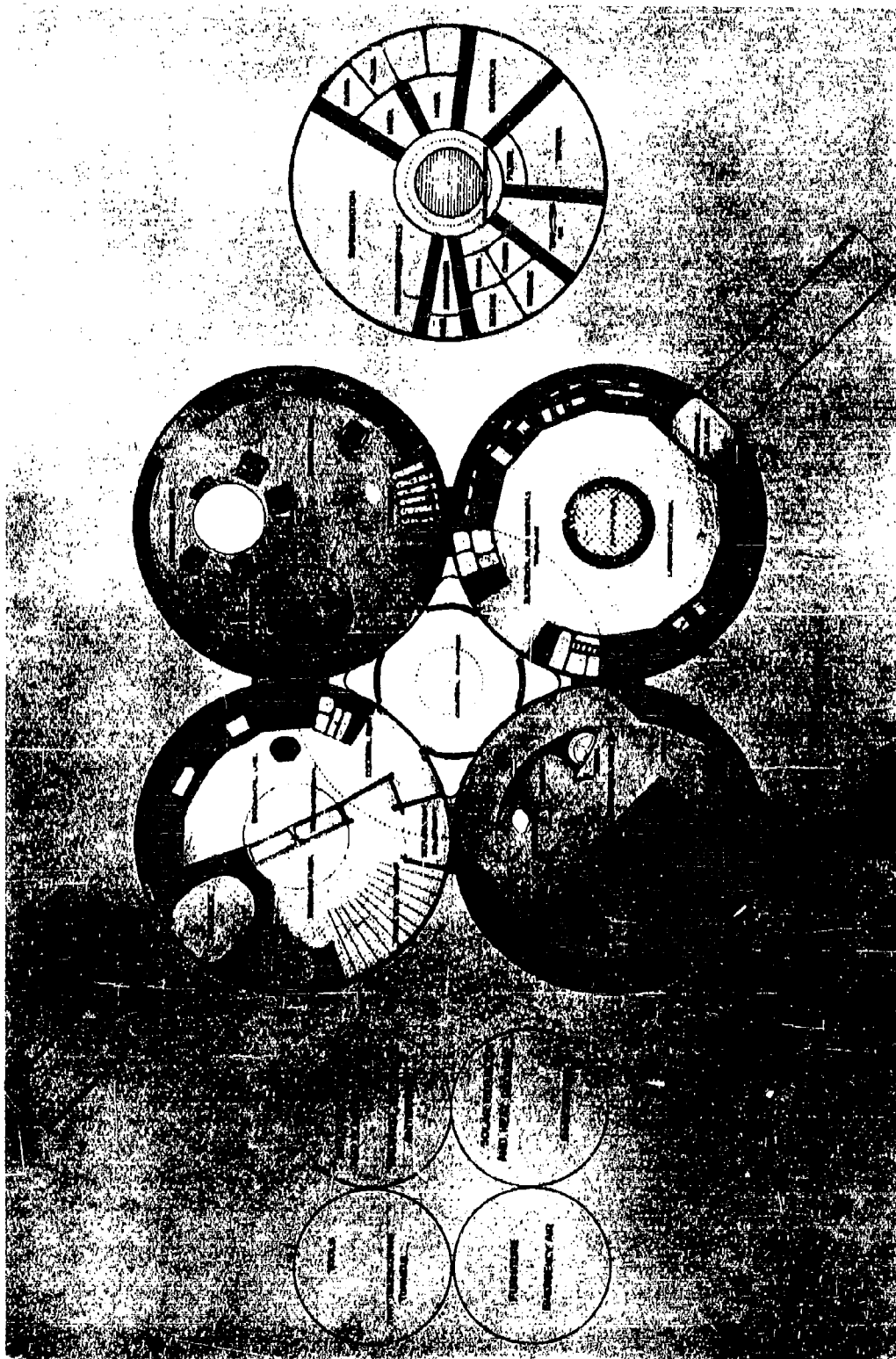

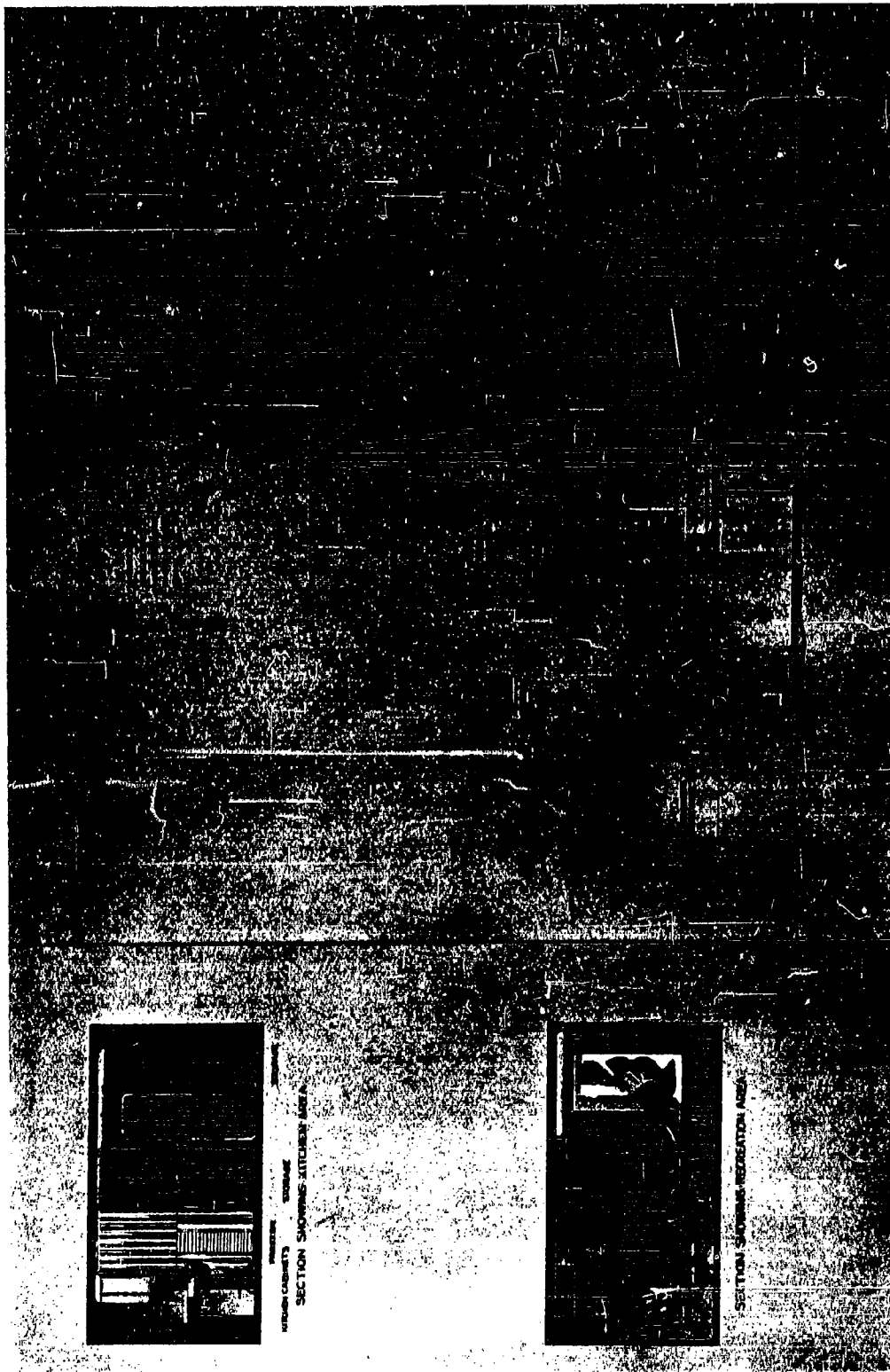

SECTION SHOWING KITCHEN AREA

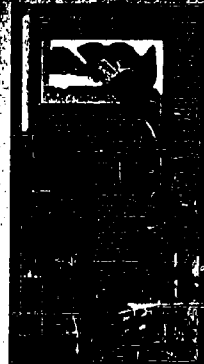

SECTION SHOWING KITCHEN AREA

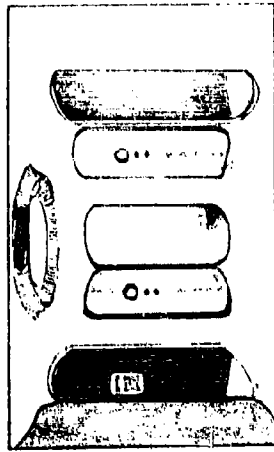

CENTRAL CHAMBER

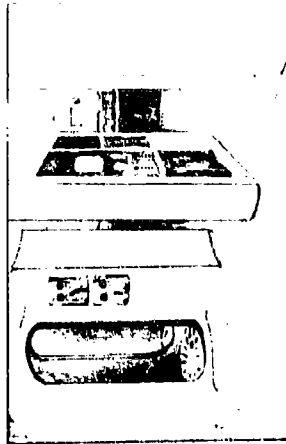

DECONTAMINATION AND BIOLOGICAL LABORATORY

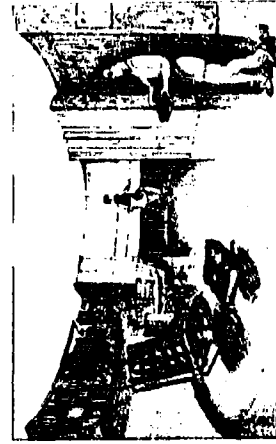

KITCHEN AND RECREATION AREA

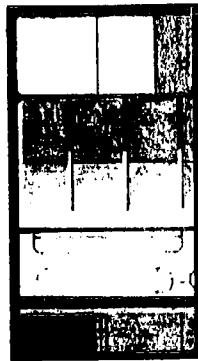

SHOWER SLEEPING

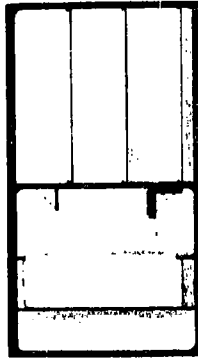

SHOWER SINK

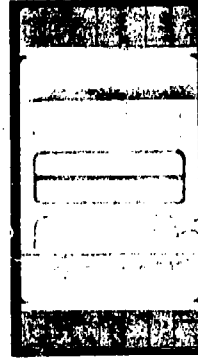

FOLD-UP SEATS SLEEPING

SECTION SHOWING BATH AND SLEEPING AREAS

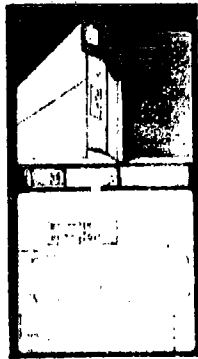

DECONTAMINATION BIOLOGICAL LABORATORY INSTRUMENTS

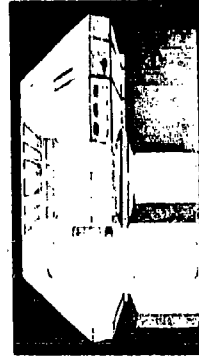

DECONTAMINATION BIOLOGICAL LABORATORY INSTRUMENTS

SECTION SHOWING LABORATORY AREA

LUNAR SHELTER CONCEPTS

by

<u>John Jappen</u>	Arch. 1964
<u>Edwin Schlesselman</u>	Ind. Des. 1963
<u>Roy Skarl, Jr.</u>	Arch. 1964
<u>Larry Whitaker</u>	Ind. Des. 1964

DESIGN PHILOSOPHY

Our concept is based upon satisfying basic minimum shelter requirements. This dictates the use of the capsule itself as the shelter. Use of the capsule will result in a minimum requirement of human and mechanical effort to erect a suitable shelter. Also, a minimum of living space will be provided which, though adequate, must be efficiently organized. We feel that such an approach is justified by several factors: First, the lunar environment makes any type of elaborate construction infeasible and undesirable, both from a human and a mechanical standpoint. This holds particularly true for the first mission which is exploratory in nature. A large, permanent base could be established later using a modular complex of these units.

Finally, experimentation and comparison with similar situations, (Submarines, Polar exploration, etc.), has shown that such a shelter is a practical and sound solution for a short term mission such as this one.

PACKAGE AND ERECTION TECHNIQUES

Most of the equipment and furnishings will be permanently secured in place prior to launching. The solar collector and heat exchanger will be collapsed and secured to the floor in the lab area. All of the other equipment remains in place after landing. The capsule will be lowered into a horizontal position by using the lower half of the rocket as a supporting and lowering device. The moon traversing device will support one end of the capsule as the other end is lowered hydraulically along tracks on the side of the rocket. Supporting "feet" will then be projected electrically until the capsule is level and stabilized. The ends will telescope out by means of building up the atmospheric pressure inside and seal on contact with a flange around the inner shell. When the capsule is in its final extended position, a corrugated, high-strength metal tunnel 15 feet in length will be fitted to both ends of the capsule. With the tunnels in place and all exterior connections complete, the entire capsule is covered with 10 feet of lunar dust.

STRUCTURE AND MATERIAL

Exterior walls, floors, and ceilings are of a double-walled sandwich type construction with a $3/8$ " outer skin, a $1/8$ " inner layer with a 3" airspace between. This space contains a reinforcing core of light metal and insulation. Two bulkheads of like construction are provided for structural and rigidizing strength. The interior is spray-coated with vinyl for acoustical and decorative properties. This will eliminate the unpleasant sensation of living in a steel tank.

FLOOR PLAN ANALYSIS

The floor plan was designed for maximum efficiency within the limited, but adequate, space provided.

Although the areas are in close proximity, each area is isolated from the others for the reduction of noise and for separating the men in one area from the other.

The lab area has been designed for the use of three men, but in case of an emergency the area may be increased by the addition of a table in the area.

A maximum amount of flexibility has been designed in the recreation area to provide for a variety of activities. By means of screens, different sections may be isolated for reading, etc.

The door dividing the lab area from the recreation area may be used as a screen for motion pictures.

Circulation in the sleeping area is limited mainly to allowing access to the auxiliary air lock and to the bunks and clothing storage.

ENVIRONMENTAL PROTECTION

Complete protection is provided by 10 feet of lunar dust. Additional protection from radiation will be obtained from the capsule itself.

INTERIOR FURNISHING AND EQUIPMENT

Recreation and food area:

Food center (freezer, refrigerator, preparation center, water)
collapsible table
couch
desk-table
book, film, and reading shelves
console and storage units
 record player
 movie projector
 game equipment

Lab area:
Communications center
biological, mineral analysis
recon lab
multi-purpose lab
storage units

Sleeping area:
5 bunks (2 auxiliary)
storage units

Lavatory:
shower
wash basin (formed plastic)
water closet (formed plastic)

STATISTICAL INFORMATION

Sleeping area:
60 sq. ft. (approx.)
420 cu. ft. (approx.)

Work area:
120 sq. ft. (approx.)
900 cu. ft. (approx.)

Air locks:
78 sq. ft. (approx.) each
780 cu. ft. (approx.) each

Recreation area:
192 sq. ft. (approx.)
1440 cu. ft. (approx.)

Bathroom:
40 sq. ft. (approx.)
280 cu. ft. (approx.)

Total length expanded: 49 ft.
diameter: 14 ft.

Total area: 646 sq. ft. (approx.)
4600 cu. ft. (approx.)
w/c air locks: 3040 cu. ft. (approx.)

THEORETICAL ADVANTAGES OF CONCEPT

The main advantage has been previously outlined: minimum effort needed for erection. In addition, the unit is self-contained and no moving of equipment is necessary. The telescoping ends provide for an air lock and emergency unit apart from the living area. All phases of the erection are mechanically accomplished. There is no dependence on foam or other materials.

By positioning the unit horizontally, the unit has stability and eliminates the need for ladders or other means of vertical transportation. Thus, we have no loss of floor space, and far less lunar dust is required for protection.

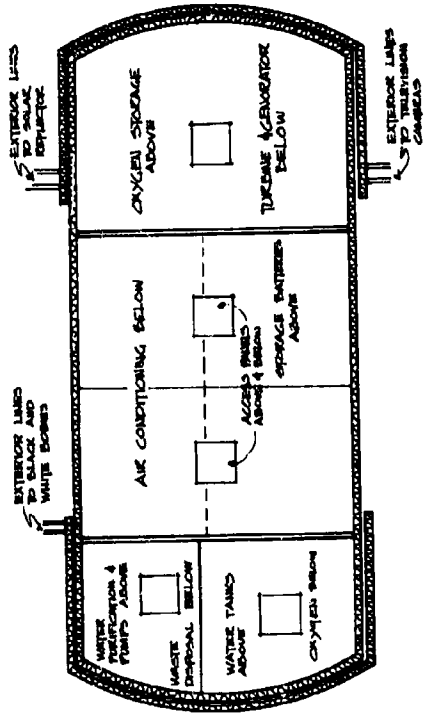

4TH STAGE

3RD STAGE

2ND STAGE

1ST STAGE

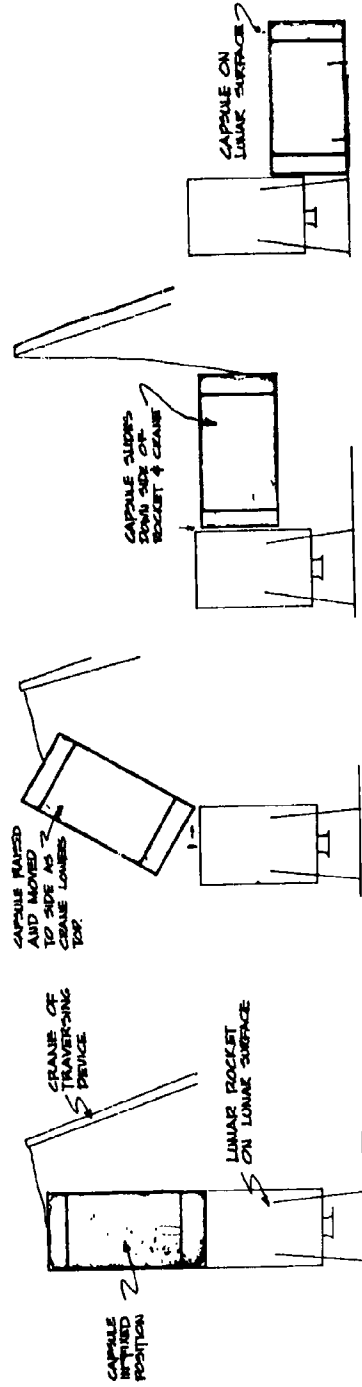

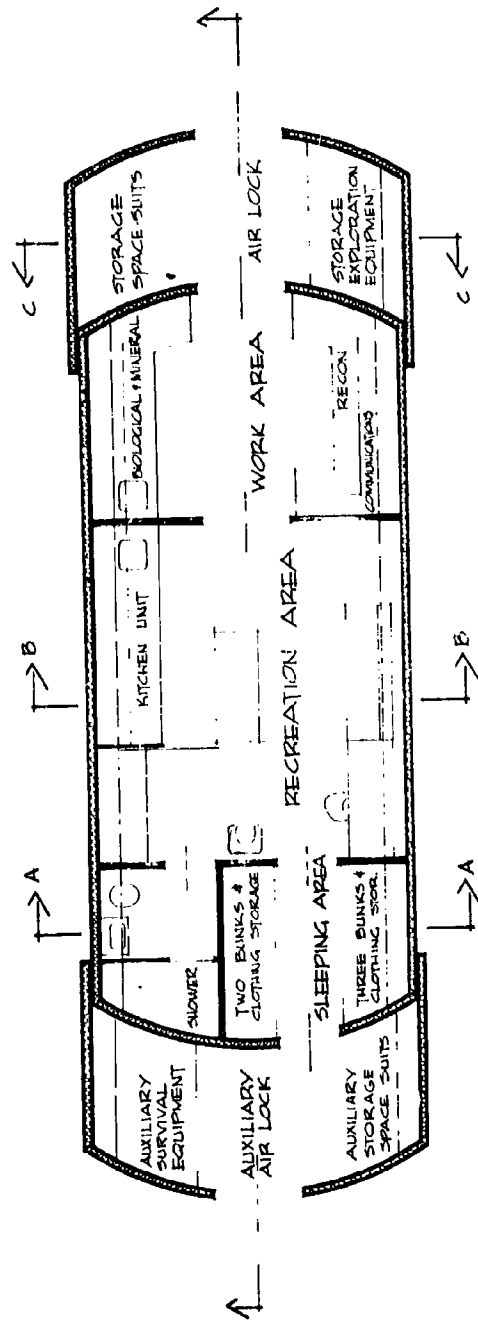

FLOOR PLAN

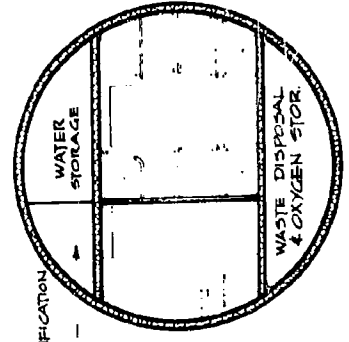

SECTION A-A

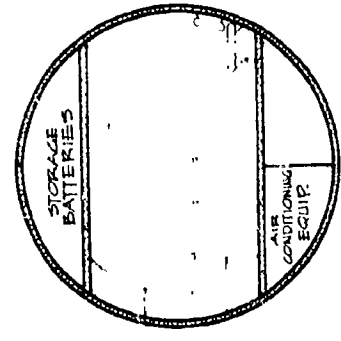

SECTION B-B

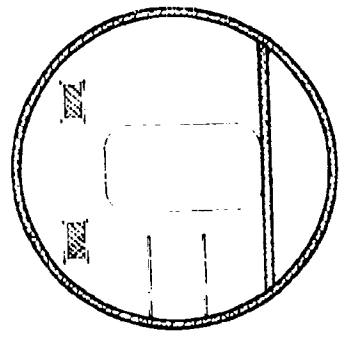

SECTION C-C



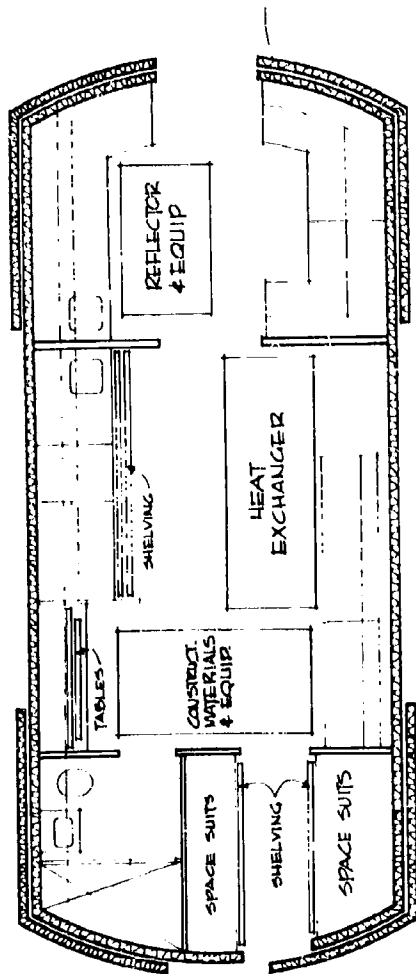

PACKAGED PLAN

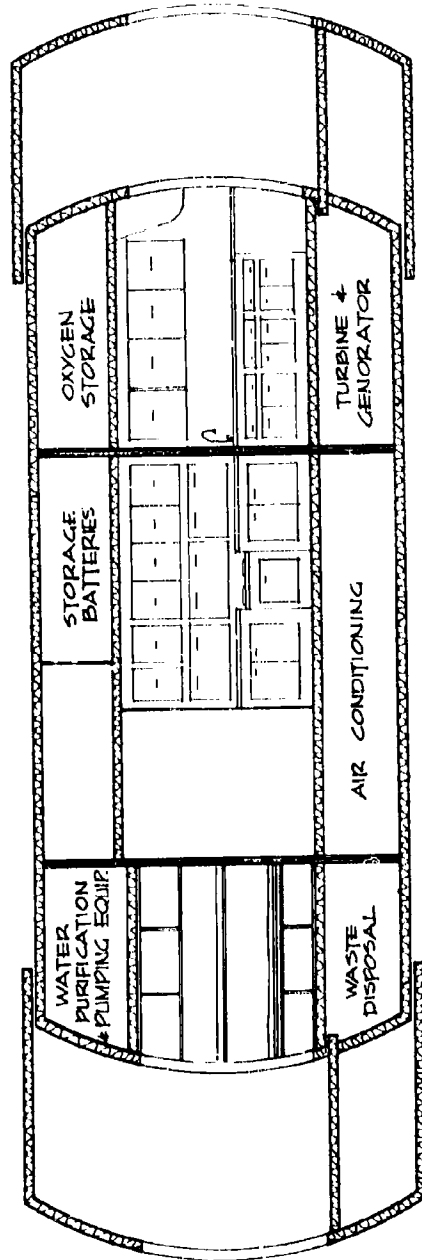

LONGITUDINAL SECTION

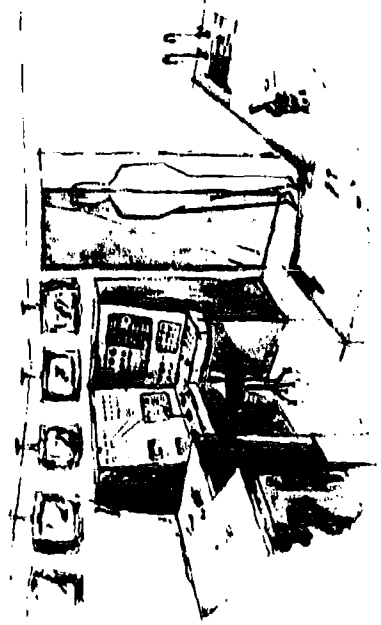
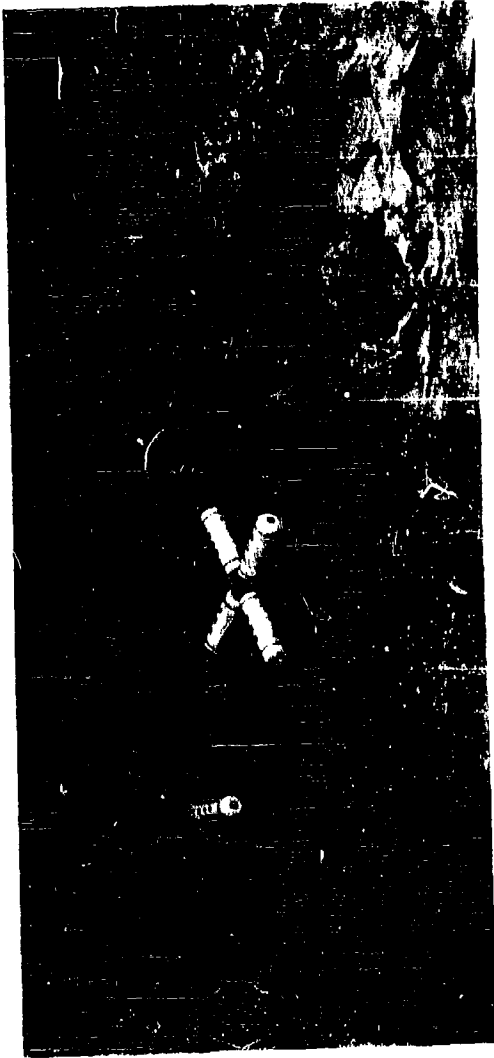

LUNAR SHELTER CONCEPTS

ROYDEN T. SCHENZ	ARCH.	'64
WILLIAM E. HICKS	ARCH.	'64
RONALD N. HYDE	IND. DES.	'64
WILLIAM D. SEIPLE	IND. DES.	'63

DESIGN PHILOSOPHY

Rapid assembly of living space and the creation of a friendly environment will be essential when the nine astronauts arrive at their destination. The creation of work and relaxation quarters compatible with familiar associations give them a sense of security on which to rely in order to accomplish the magnificent goals toward which they aspire.

PACKAGE AND ERECTION TECHNIQUES

The packaging of the Lunar Shelter living unit structure is accomplished within the designated 14 x 35 foot capsule, but the nose cone will also be utilized.

The capsule will be lowered to the ground by one of two ways:

- (1) The tractor will pile up dust & rubble to the level of the capsule. A balloon will be inflated around the capsule, which is then guided down the hill by the tractor. The balloon is deflated and the assembly of the living quarters com-

menced.

- (2) The rocket motor and fuel tank unit is detached from the portion of the booster to which the landing struts are attached. The landing struts are then folded to bring the capsule within a few feet of the surface of the moon. The tractor then lowers the capsule to the ground.

Following the location of the capsule on the desired site, the tractor breaks the bonding seal, pneumatic jacks built into the structure are utilized to transform the capsule itself into the airtight living unit.

The unit is pressurized and started functioning.

The out-units (solar collector, black body radiators, etc.) are removed from capsule and connected by foamed tubing to living unit. The living unit is covered by ten (10) feet of lunar dust and rubble. It is now ready for occupancy.

STRUCTURES AND MATERIALS

- A. The outer shell of living unit will be the same as the space craft (sheet metal sandwich).
- B. The inner membrane, which is sealed to prevent infiltration of lunar environment, is silicone plastic (flexible at -300° F.).
- C. The exterior piping and living unit access tunnel are foamed tubing.
- D. The solar collector is an inflated structure.

STRUCTURES AND MATERIALS (Cont'd)

- E. Interior walls are air-mat which is pre-positioned and bonded to ceilings.
- F. Interior ceilings are sound absorbing.

FLOOR PLAN ANALYSIS

- A. The linear wall treatment is familiar and functional.
- B. A ceiling of seven (7) foot minimum height helps alleviate any claustrophobic tendencies.
- C. All floor space is usable. Minimum circulation.

ENVIRONMENTAL PROTECTION

- A. Inner membrane of tough, flexible plastic. Completely sealed except for airlock and equipment "plug-ins."
- B. Strong metal skin supported by:
 - (1) Air-mat walls.
 - (2) Triangulated metal sandwich panels at ends.
 - (3) Locked pneumatic jacks.
- C. Long access tunnel from outside to airlock.
- D. Mound of rubble or crater rim shielding entrance to access tunnel.
- E. Decontamination shower in inner airlock chamber.
- F. Isolated space suit storage and entrance chamber.
- G. Ten (10) feet of lunar dust over entire structure.

INTERIOR FURNISHINGS AND EQUIPMENT INTEGRATION

- A. Mechanical equipment

INTERIOR FURNISHINGS AND EQUIPMENT INTEGRATION (Cont.'d)

- (1) Air purifying, conditioning equipment.
- (2) Oxygen regenerating equipment.
- (3) Heat exchange equipment.
- (4) Power equipment.
- (5) Water purification equipment.
- B. Airlock equipment
 - (1) Space suit storage.
 - (2) Double chamber airlock.
 - (3) Decontamination shower (in inner airlock).
 - (4) Air compressor.
- C. Laboratory equipment
 - (1) Geological
 - (2) Biological
 - (3) Astronomic
 - (4) Radiological
 - (5) Photographic
 - (6) Logistics & Records
- D. Communications equipment
 - (1) Television
 - (2) Radar
 - (3) Long distance radio (moon to earth)
 - (4) Field survey team radio
- E. Isolation equipment
 - (1) Two (2) bunks
 - (2) Medical and first-aid equipment
- F. Bathroom equipment
 - (1) Water closet
 - (2) Shower
 - (3) Sink
 - (4) Personal storage
- G. Sleeping room equipment
 - (1) Three (3) bunks
 - (2) Personal storage

STATISTICAL INFORMATION

	Sq. Ft.	Cu. Ft.
L. Floor area-----	845.25	-----
M. Area at maximum interior width-----	914.25	-----
N. Interior volume-----	-----	8281.33

THEORETICAL ADVANTAGES OF CONCEPT

- A. Rapid assembly.
- B. Utilization of entire capsule and nose-cone.
- C. High strength shell and support.
- D. No possible direct-line radiation hazard.
- E. Maximum utilization of wall space.
- F. All floor space usable (minimum circulation).
- G. Familiar type interior environment.
- H. Easy access due to horizontal airlock.
- J. Double safety airlock to prevent jamming.
- K. Minimum amount of moving parts for erection.

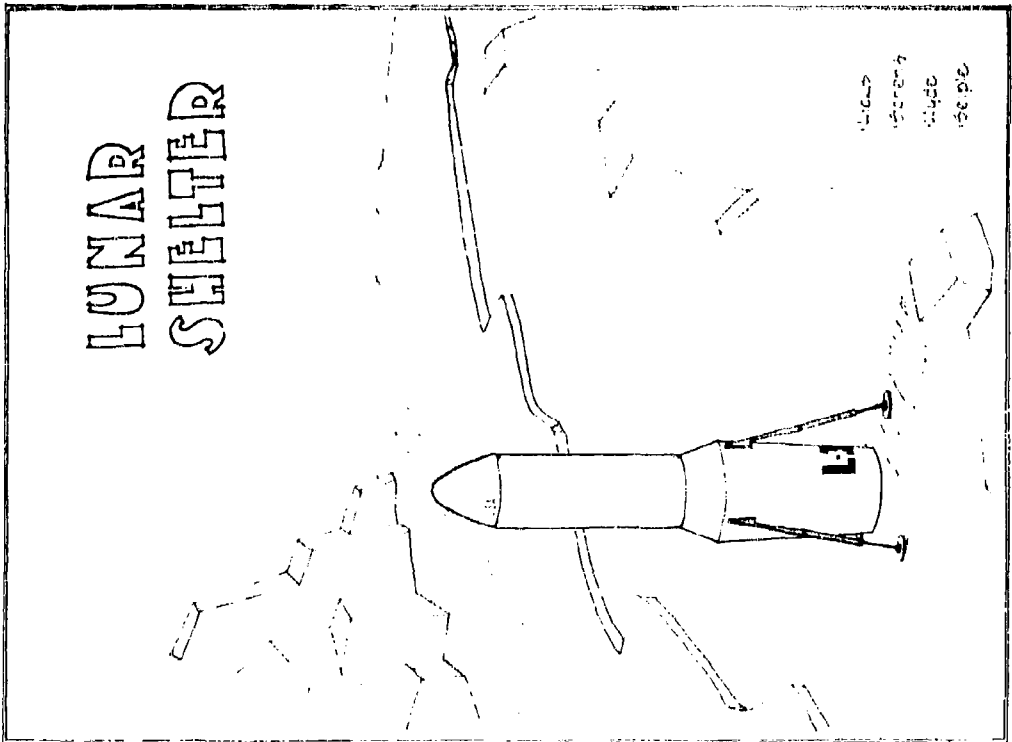
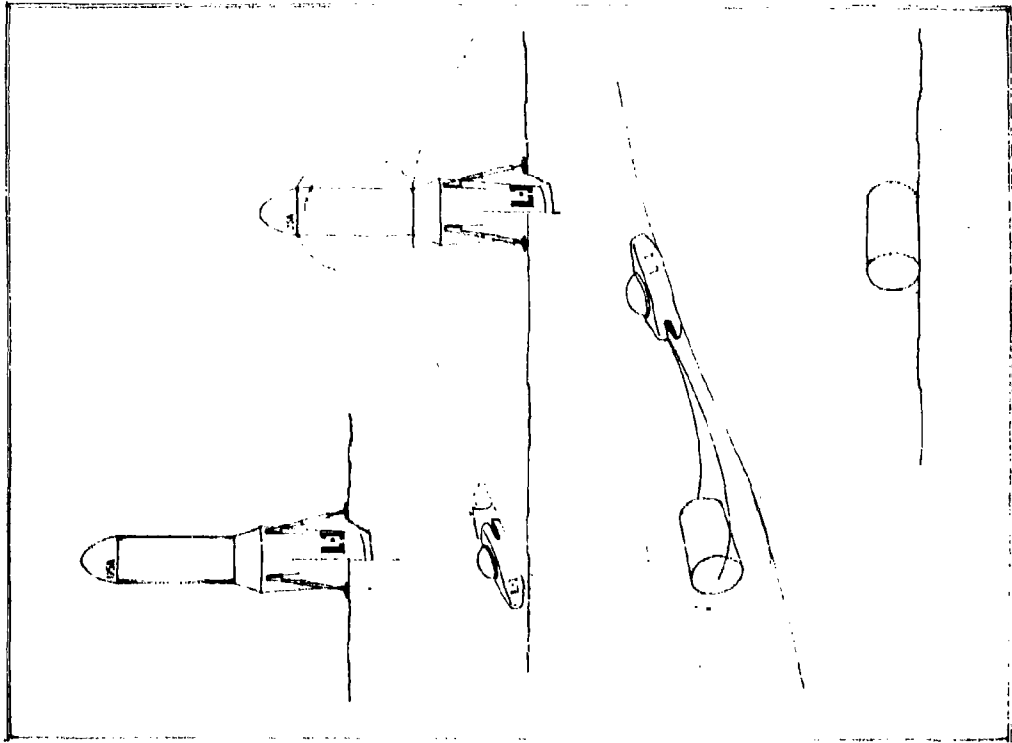

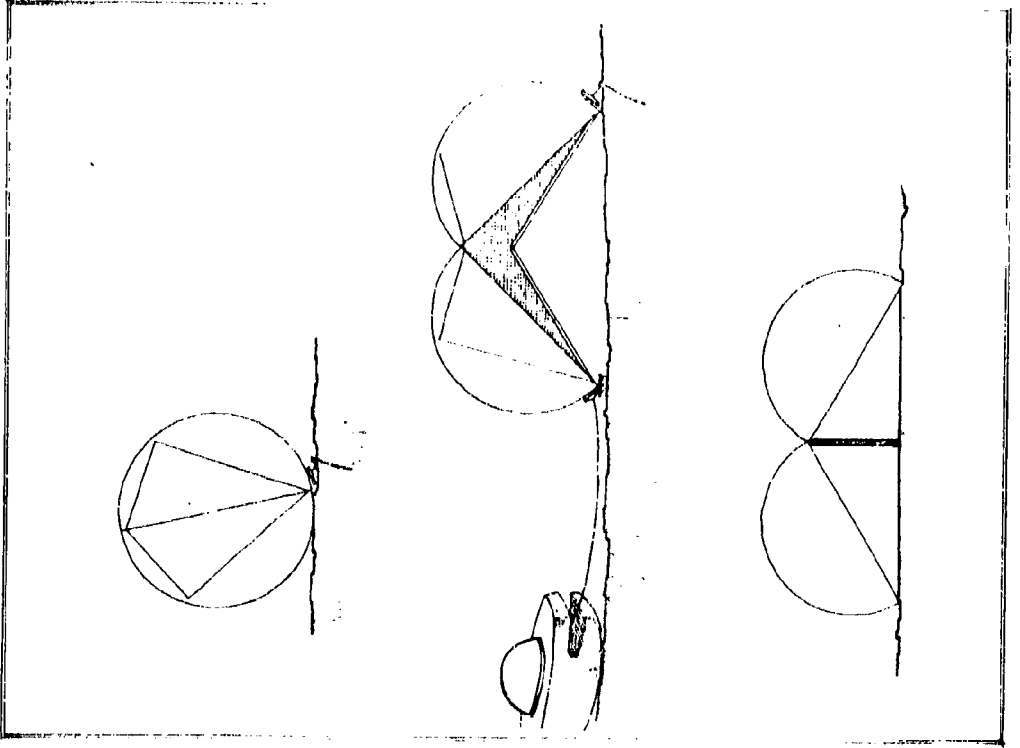
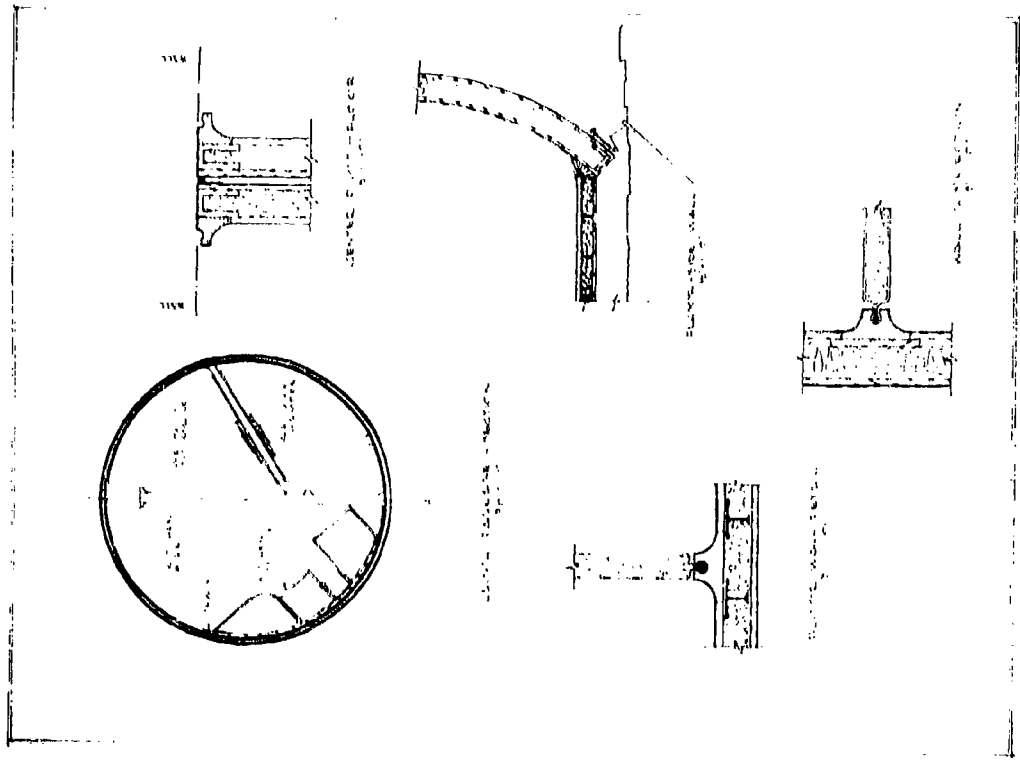

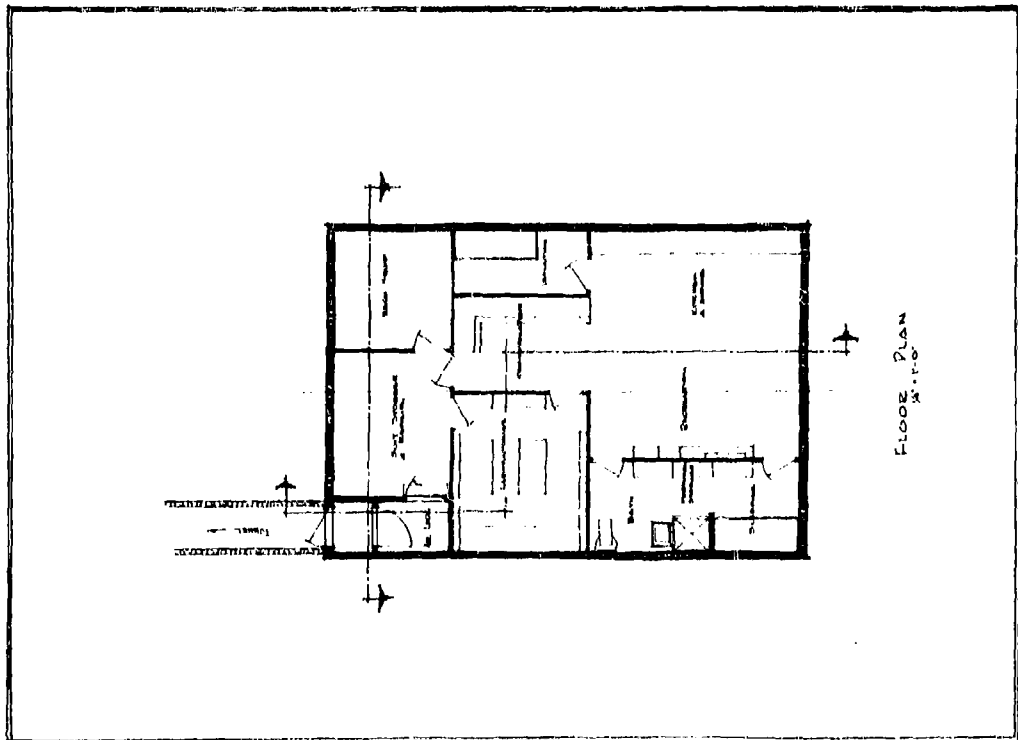
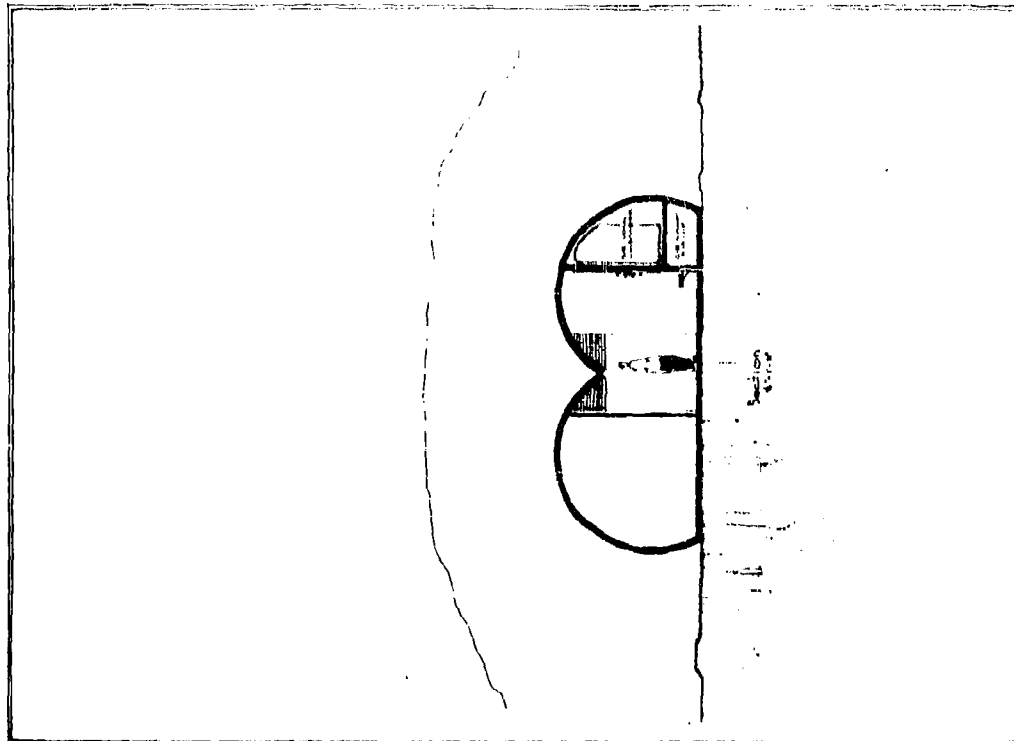

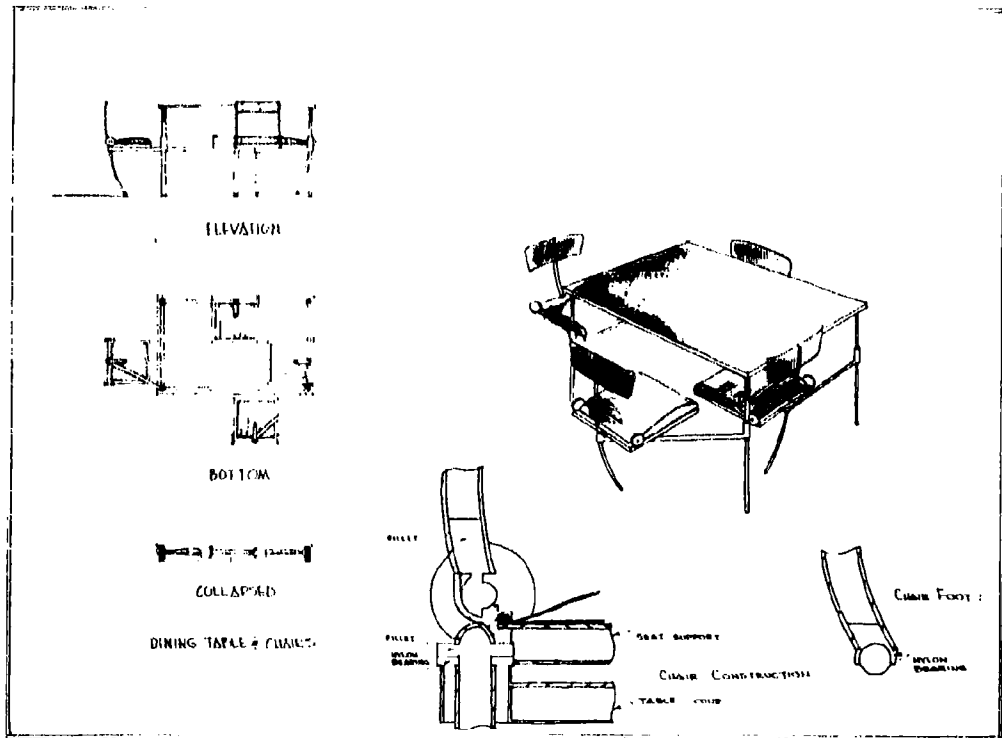
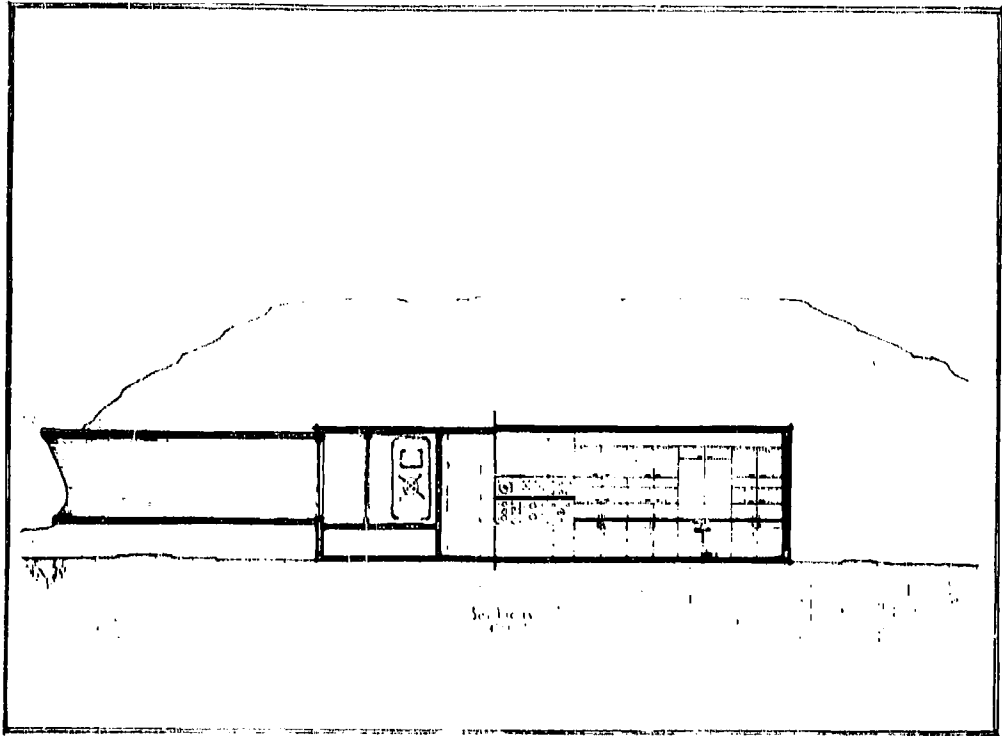

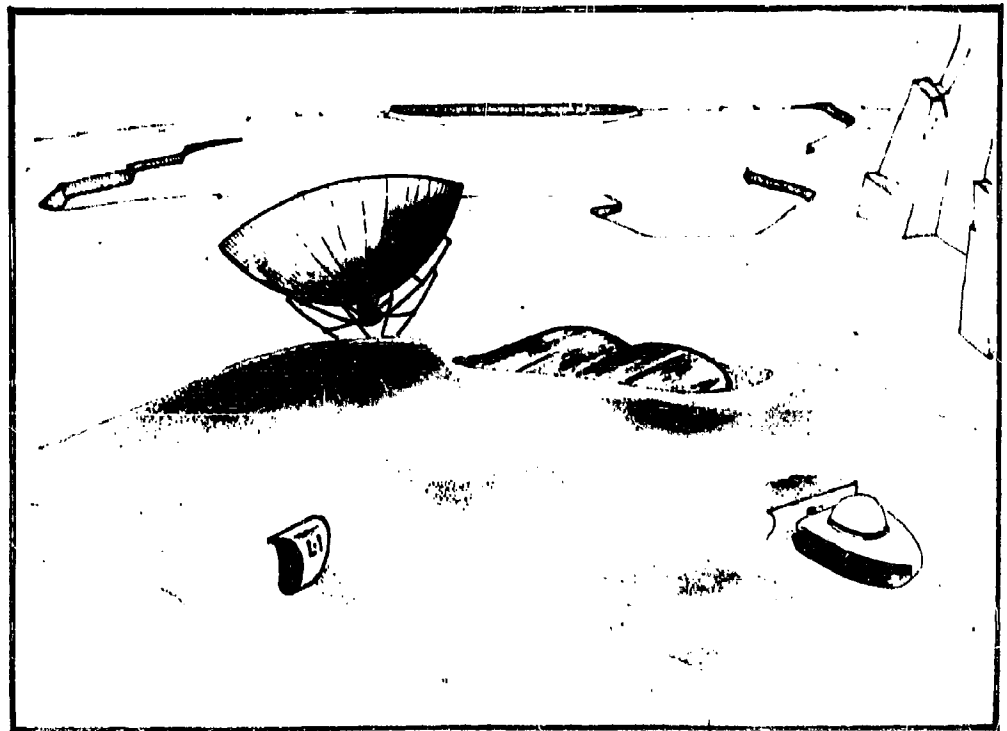
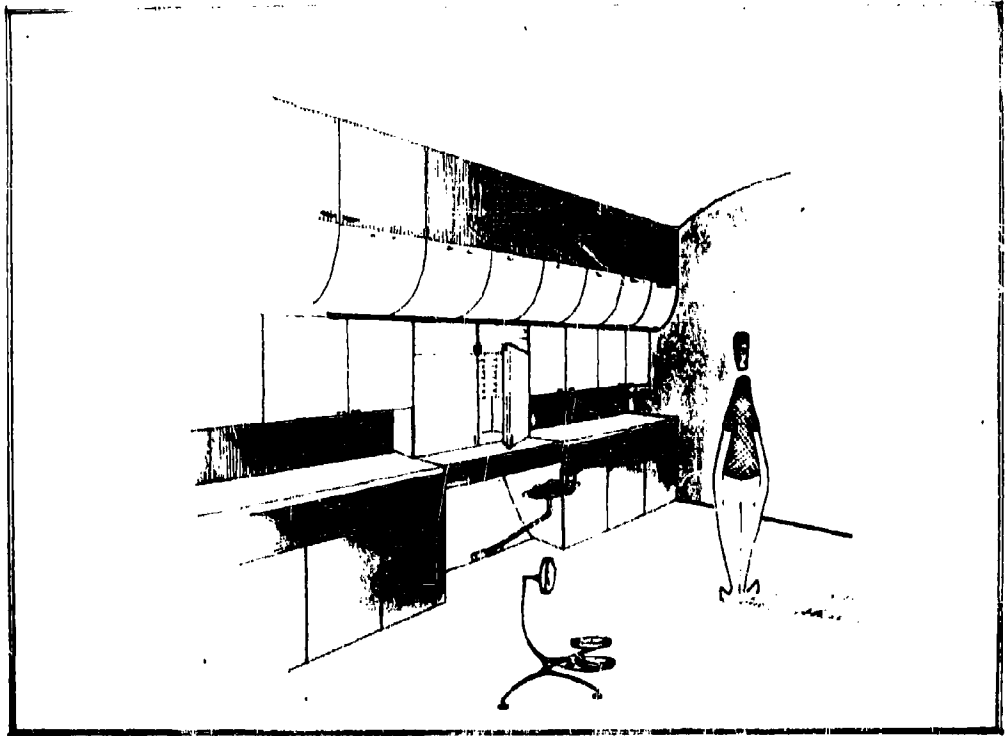



LUNAR SHELTER CONCEPTS

by:

Gary Lesniewicz Arch. '64

Roger Short Arch. '64

George Smith Ind. Des. '63

Larry Vanover Ind. Des. '64

University of Cincinnati

College of Design, Architecture and Art

29 July 1962

PHILOSOPHY

Our philosophy is composed of three basic principles:

- A. Organic growth.
The spaces emanate from the core area as segments of an orange radiate from a central nucleus.
- B. The inflatable balloon.
The balloon is a determining factor in the concept by reason of the nature and limitations inherent in working with the balloon as the structural basis of the problem.
- C. Airlock.
The airlock's import to the lunar base community and the importance of its location in relation to the shelter led to a degree of prominence in the design solution.

PACKAGE AND ERECTION TECHNICS:

PACKAGING:

Our package consists of two basic units, the shelter unit and solar collector. Their heights would permit use of a thirty foot cylinder. The units would be positioned in the cylinder so that the collector is in the top over the shelter unit.

In our solution the heavy equipment is located in the stebesite. Care is given in the location of equipment so that a balance is achieved which would prevent spinning due to an off-center load.

The basic steps in unloading of the shelter are:

1. A hole is blasted by a shot from the cylinder just prior to loading.
2. Legs are lowered from the cylinder.

PACKAGE AND ERECTION TECHNIQS: (cont.)

3. The cylinder lands, and the bottom drops away.
4. The shelter is lowered to the machine by an internal skeletal dispenser.
5. The solar collector is lowered onto the dispenser by means of an internal hoist, then is lowered in turn to the machine.

ERECTION:

Erection of the shelter is outlined by the following steps:

- A. Shelter unit is lowered into hole by machine.
- B. Hydraulic jacks raise the shelter proper from the atebes (sub-terrain emergency base) to the grade level (approx. ten feet).
- C. The inner balloon is inflated while the hole is being filled in.
- D. Catalyst is released into the inner balloon which contains partially-catalized foam plastic.
- E. The plastic foams and expands within the inner balloon until the pre-determined limits imposed by cross hairs are reached, giving the desired cross-section.
- F. The structure is now habitable, and men may now enter to set up the equipment.

STRUCTURES AND MATERIALS:

The strength of the structure is developed from the rigid foam plastic shell. This foaming is allowed to flow into the hollow walls of atebesite forming a bond between the balloon and the core. The shelter is also given stability by the atebes below the grade.

STRUCTURES AND MATERIALS: (cont.)

The shell is composed of an outer skin with a metallic coating, an inner skin of plastic, and a filling between the two of rigid foam plastic. The observation dome is of Fotoceram, a high strength glass product.

FLOOR PLAN ANALYSIS:

The basis for our planning is the assumption that there would be no integration of the three shifts: working, sleeping, and leisure. This assumption permits relationships that might be objectionable under a different set of conditions.

Entry to the shelter is made through the stebesite, which contains the airlock and suit storage. Above the stebesite is the main area of the shelter, containing the working and living spaces.

Below the stebesite is the stebes. This would be used by the nine men during solar flares. As more teams are sent, the stebes would become a core for access to the additional underground bases. In that case the shelter could become a common entry for several underground bases radiating from the stebes.

An observation dome is incorporated into our design to allow scientific-astronomical observations to be made during the lunar night without leaving the shelter. During the lunar day a shutter-like apparatus would

FLOOR PLAN ANALYSIS: (cont.)

close and protect the work area below.

ENVIRONMENTAL PROTECTION:

There are three major elements against which protection must be provided at the lunar base:

1. Temperature
2. Radiation
3. Meteoroids

As protection against both temperature and average lunar radiation, the shell of our shelter is composed of a rigid foamed plastic. This protection would be insufficient during a solar flare so, as a safeguard, an emergency shelter is buried ten feet below the lunar surface. The water supply for the lunar base is stored in the stebes. Emergency rations also are placed in the stebes. Meteoroids are protected against by the shell.

INTERIOR FURNISHINGS AND EQUIPMENT INTEGRATION:

Many of the furnishings are incorporated into the shelter itself, as the flowing quality of the foaming plastic would allow benches, tables, etc. to be formed as integral parts of the structure. Integration of equipment is also achieved by predetermined compartments in the structure into which specific modular units are installed. Some of our furnishings will be

INTERIOR FURNISHINGS AND EQUIPMENT INTEGRATION: (cont)

constructed of the packing containers of miscellaneous equipment.

Color would be introduced through the equipment and clothing, the interior spaces being neutral in color.

Furnishings are held to a minimum by providing for only the three man teams for each function.

Utilities are also incorporated into the structure.

Plumbing will be transmitted by flexible tubing incorporated into the foam plastic inner wall. Outlets in the ceilings will accommodate fixtures to provide the necessary 40 p.c. of light.

STATISTICAL INFORMATION:

<u>Room</u>	<u>Square Footage</u>	<u>Cubic Footage</u>
Laboratory	300	2400
Recreation	160	1280
Emergency Sleeping	90	560
Sleeping	180	1440
Toilets	60	480
Shower	30	240
Research Storage	30	240
Food Storage	40	320
Food Preparation	50	400
Eating	100	800
Stebesite	115	920

STATISTICAL INFORMATION: (cont.)

<u>Room</u>	<u>Square footage</u>	<u>Cubic Footage</u>
Stebes	115	920
Total	1250 sq.ft.	10,000 cu.ft.

THEORETICAL ADVANTAGES OF THIS CONCEPT:

- A. Rapid erection time.
- B. Lack of involvement.
- C. Adequate protection without a covering of lunar dust.
- D. Observation dome will allow scientific surveys to be made from within the structure.



LUNAR SHELTER

G. E. LINDENHAY

L. A. MORTON

G. L. SMITH

B. L. STUBBS

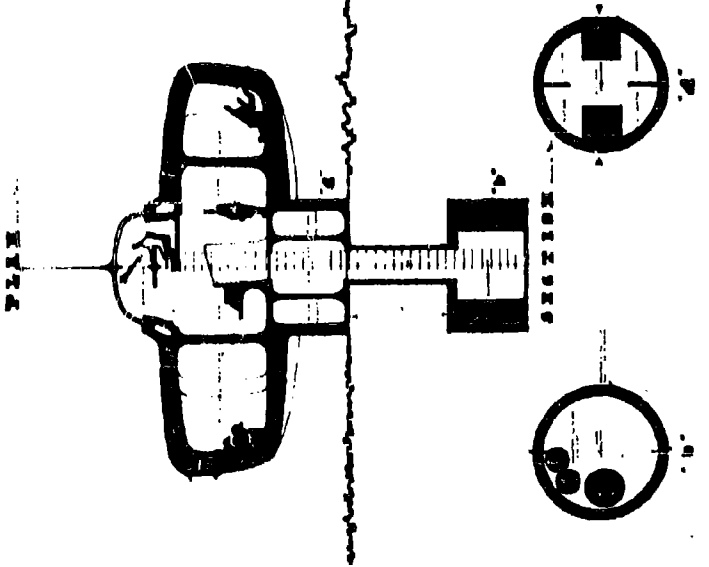
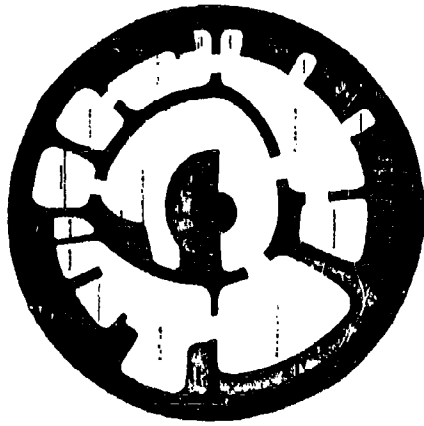

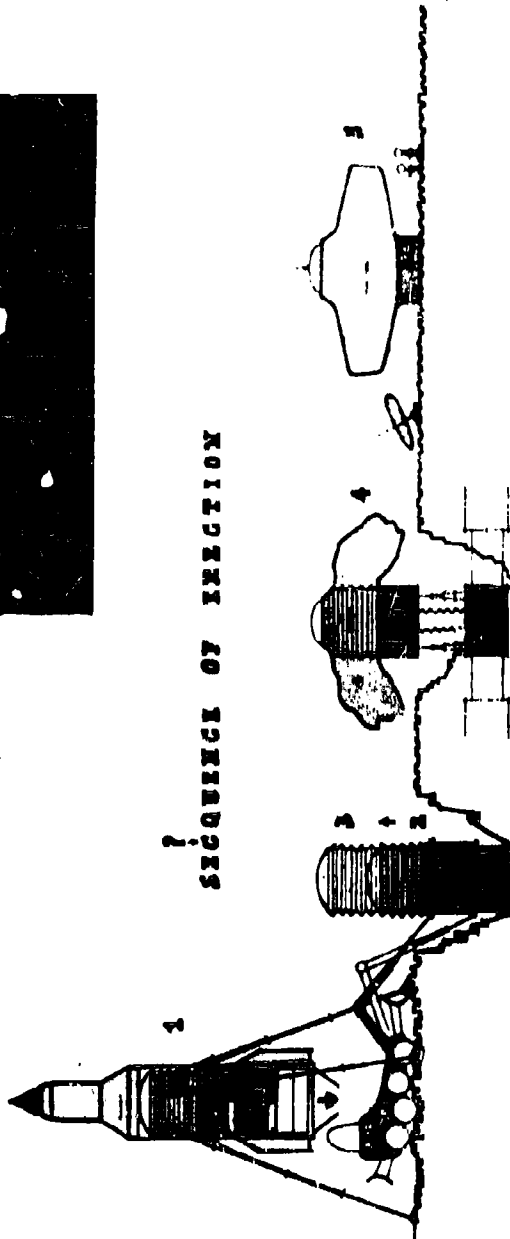
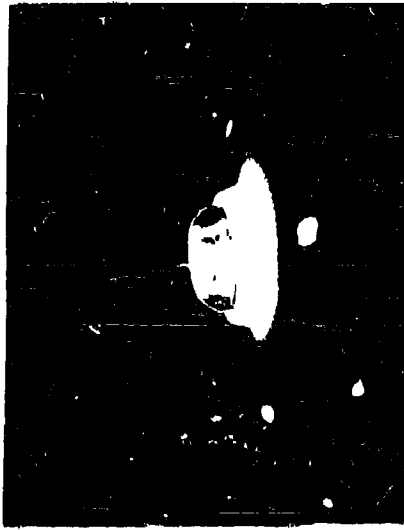
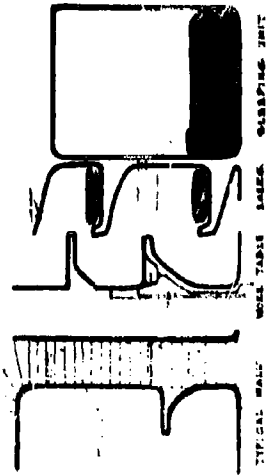

SEQUENCE OF INJECTION

